



Chipsmall Limited consists of a professional team with an average of over 10 year of expertise in the distribution of electronic components. Based in Hongkong, we have already established firm and mutual-benefit business relationships with customers from,Europe,America and south Asia,supplying obsolete and hard-to-find components to meet their specific needs.

With the principle of "Quality Parts,Customers Priority,Honest Operation,and Considerate Service",our business mainly focus on the distribution of electronic components. Line cards we deal with include Microchip,ALPS,ROHM,Xilinx,Pulse,ON,Everlight and Freescale. Main products comprise IC,Modules,Potentiometer,IC Socket,Relay,Connector.Our parts cover such applications as commercial,industrial, and automotives areas.

We are looking forward to setting up business relationship with you and hope to provide you with the best service and solution. Let us make a better world for our industry!



Contact us

Tel: +86-755-8981 8866 Fax: +86-755-8427 6832

Email & Skype: info@chipsmall.com Web: www.chipsmall.com

Address: A1208, Overseas Decoration Building, #122 Zhenhua RD., Futian, Shenzhen, China



3.5 mm×2.9 mm Side-operational SMD Light Touch Switches

Type: **EVQP7/EVQP3/EVQ9P7**

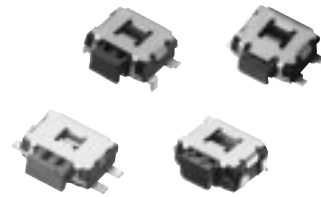

■ Features

- External dimensions : 3.5 mm×2.9 mm, Height 1.35 mm
- A wide range of terminal type : L-shape, J-bent, Straight
- High mount ability
- Push plate strength enhanced type

■ Recommended Applications

- Car navigation, Car audio

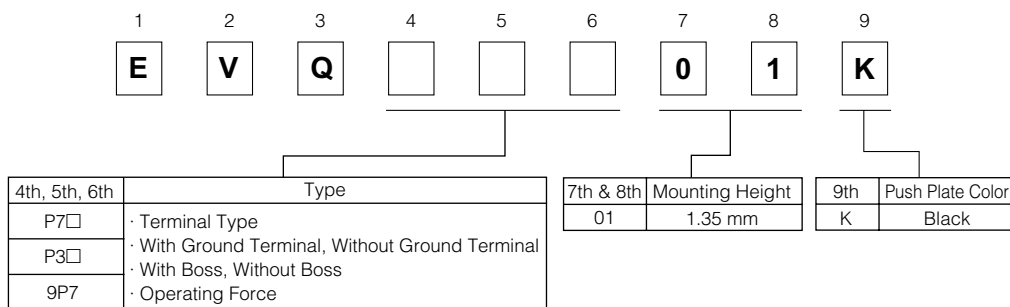

■ Explanation of Part Numbers



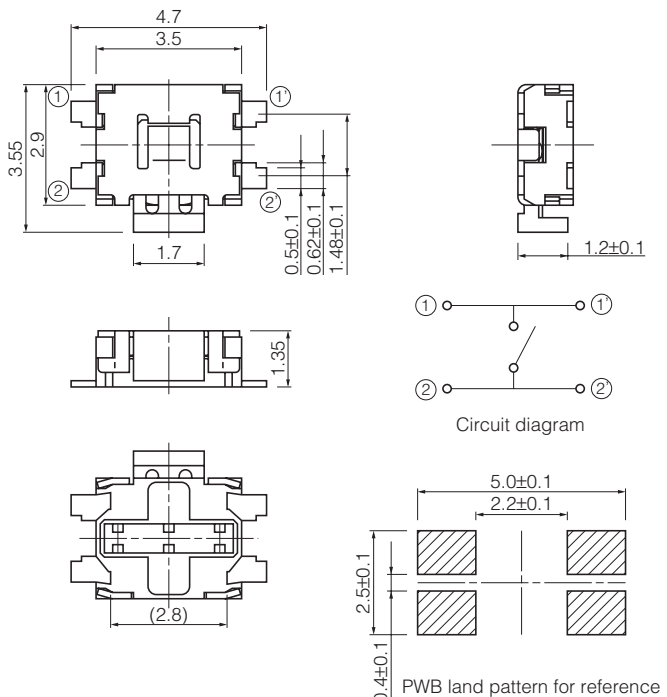

■ Specifications

Type	Snap action / Push-on type SPST	
Electrical	Rating	10 μ A 2 Vdc to 50 mA 12 Vdc (Resistive load)
	Contact Resistance	500 m Ω max.
	Insulation Resistance	100 M Ω min. (at 100 Vdc)
	Dielectric Withstanding Voltage	250 Vac (1 minute)
	Bouncing	10 ms max. (ON, OFF)
Mechanical	Operating Force	1.6 N, 2.2 N
	Push Travel	0.2 mm
	Push Strength	30 N (1 minute)
Endurance	Operating Life	100000 cycles min.
Operating Temperature		-20 °C to +70 °C
Storage Temperature		-40 °C to +85 °C (Bulk)
		-20 °C to +60 °C (Taping)
Minimum Quantity/Packing Unit		5000 pcs. Embossed Taping (Reel Pack)
Quantity/Carton		25000 pcs.

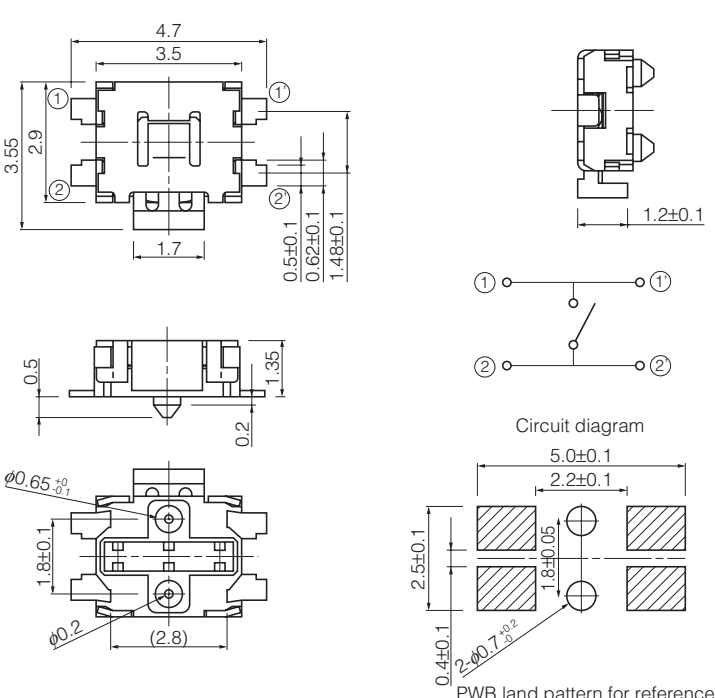
■ Dimensions in mm (not to scale)

<p>No. 1</p> <p>EVQP7A EVQP7J</p> <p>(Embossed Taping)</p> <p>With straight terminals Without boss</p> 				
<p>Part Numbers</p>	<p>Operating Force</p>	<p>Height</p>	<p>Push Plate Color</p>	<p>Operating Life</p>
<p>EVQP7A01K</p>	<p>2.2 N</p>	<p>1.35 mm</p>	<p>Black</p>	<p>100000 cycles</p>
<p>EVQP7J01K</p>	<p>1.6 N</p>	<p>1.35 mm</p>	<p>Black</p>	<p>100000 cycles</p>
<p>No. 2</p> <p>EVQP7C EVQP7L</p> <p>(Embossed Taping)</p> <p>With straight terminals With boss</p> 				
<p>Part Numbers</p>	<p>Operating Force</p>	<p>Height</p>	<p>Push Plate Color</p>	<p>Operating Life</p>
<p>EVQP7C01K</p>	<p>2.2 N</p>	<p>1.35 mm</p>	<p>Black</p>	<p>100000 cycles</p>
<p>EVQP7L01K</p>	<p>1.6 N</p>	<p>1.35 mm</p>	<p>Black</p>	<p>100000 cycles</p>

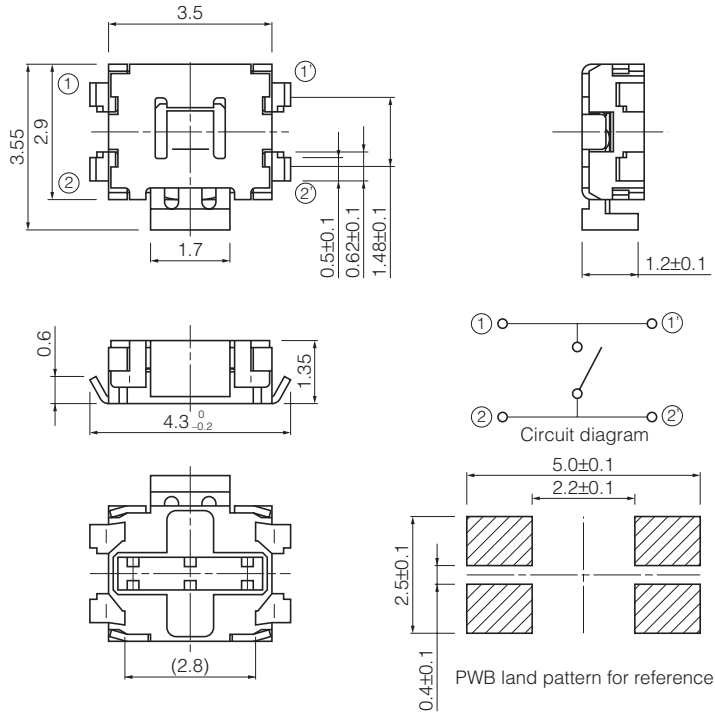
■ Dimensions in mm (not to scale)

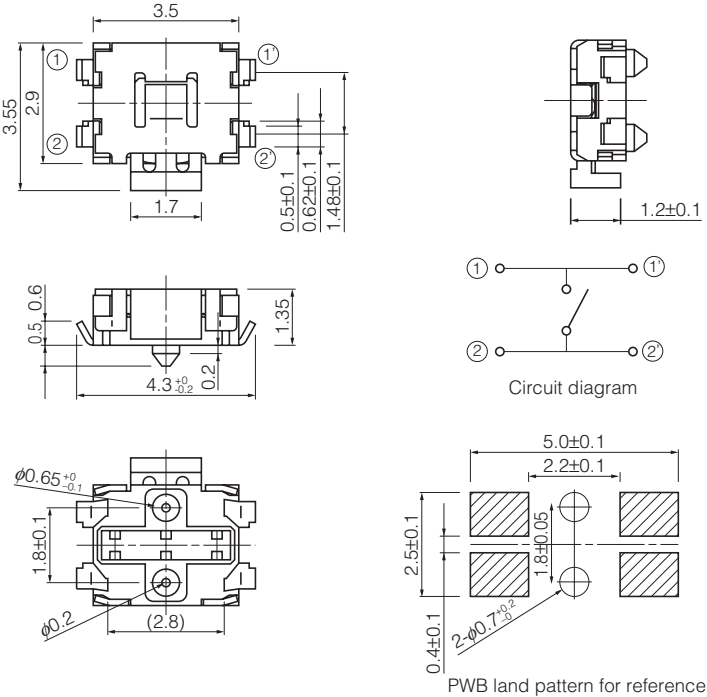
<p>No. 3</p> <p>EVQP7B EVQP7K</p> <p>(Embossed Taping)</p> <p>With J-bent terminals Without boss</p> 				
<p>Part Numbers</p>	<p>Operating Force</p>	<p>Height</p>	<p>Push Plate Color</p>	<p>Operating Life</p>
<p>EVQP7B01K</p>	<p>2.2 N</p>	<p>1.35 mm</p>	<p>Black</p>	<p>100000 cycles</p>
<p>EVQP7K01K</p>	<p>1.6 N</p>	<p>1.35 mm</p>	<p>Black</p>	<p>100000 cycles</p>
<p>No. 4</p> <p>EVQP7D EVQP7M</p> <p>(Embossed Taping)</p> <p>With J-bent terminals With boss</p> 				
<p>Part Numbers</p>	<p>Operating Force</p>	<p>Height</p>	<p>Push Plate Color</p>	<p>Operating Life</p>
<p>EVQP7D01K</p>	<p>2.2 N</p>	<p>1.35 mm</p>	<p>Black</p>	<p>100000 cycles</p>
<p>EVQP7M01K</p>	<p>1.6 N</p>	<p>1.35 mm</p>	<p>Black</p>	<p>100000 cycles</p>

■ Dimensions in mm (not to scale)

No. 5 EVQP3 EVQ9P (Embossed Taping) With L-shape terminals Without boss				
			<p>Circuit diagram</p>	
			<p>PWB land pattern for reference</p>	
Part Numbers	Operating Force	Height	Push Plate Color	Operating Life
EVQP3401K	2.2 N	1.35 mm	Black	100000 cycles
EVQ9P701K	1.6 N	1.35 mm	Black	100000 cycles

■ Recommended Reflow Soldering Conditions

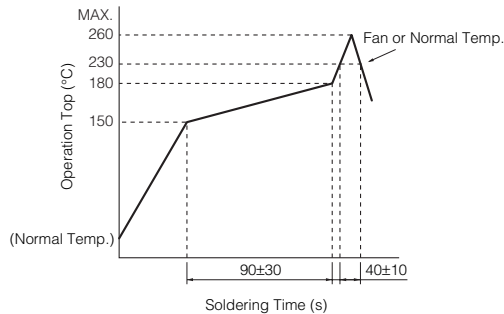

● Embossed Carrier Taping

Tape width=12.0 mm

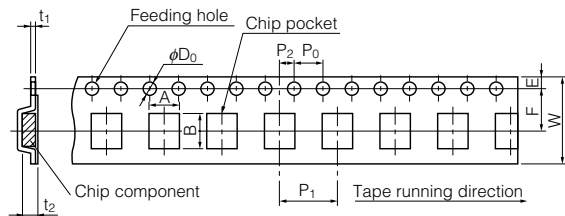

● Straight terminals, L-shape terminals type

Unit: mm

Part No.	Height	A	B	W	F	E	P ₁	P ₂	P ₀	D ₀ Dia.	t ₁	t ₂
EVQP7, EVQP3 EVQ9P7	1.35	5.2±0.2	4.5±0.2	12.0±0.3	5.5±0.1	1.75±0.10	8.0±0.1	2.0±0.1	4.0±0.1	1.5 ^{+0.1} ₋₀	0.3±0.1	1.5±0.2

● J-bent type

Unit: mm

Part No.	Height	A	B	W	F	E	P ₁	P ₂	P ₀	D ₀ Dia.	t ₁	t ₂
EVQP7, EVQP3	1.35	4.5±0.2	4.5±0.2	12.0±0.3	5.5±0.1	1.75±0.10	8.0±0.1	2.0±0.1	4.0±0.1	1.5 ^{+0.1} ₋₀	0.3±0.1	1.5±0.2

● Standard Reel Dimensions in mm (not to scale)

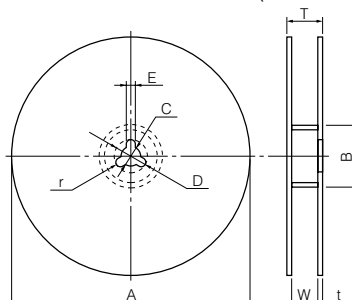

Item	A	B	C	D	E
Rate (mm)	φ380.0±2.0	φ80.0±1.0	φ13.0±0.5	φ21.0±1.0	2.0±0.5
Item	W	T	t	r	
Rate (mm)	13.5±1.0	17.5±1.0	1.0 to 3.0	1.0±0.5	