



Chipsmall Limited consists of a professional team with an average of over 10 year of expertise in the distribution of electronic components. Based in Hongkong, we have already established firm and mutual-benefit business relationships with customers from,Europe,America and south Asia,supplying obsolete and hard-to-find components to meet their specific needs.

With the principle of “Quality Parts,Customers Priority,Honest Operation,and Considerate Service”,our business mainly focus on the distribution of electronic components. Line cards we deal with include Microchip,ALPS,ROHM,Xilinx,Pulse,ON,Everlight and Freescale. Main products comprise IC,Modules,Potentiometer,IC Socket,Relay,Connector.Our parts cover such applications as commercial,industrial, and automotives areas.

We are looking forward to setting up business relationship with you and hope to provide you with the best service and solution. Let us make a better world for our industry!



## Contact us

Tel: +86-755-8981 8866 Fax: +86-755-8427 6832

Email & Skype: info@chipsmall.com Web: www.chipsmall.com

Address: A1208, Overseas Decoration Building, #122 Zhenhua RD., Futian, Shenzhen, China





General dimension tolerance:  $\pm 0.2$   
 ( ) dimensions are reference dimensions.

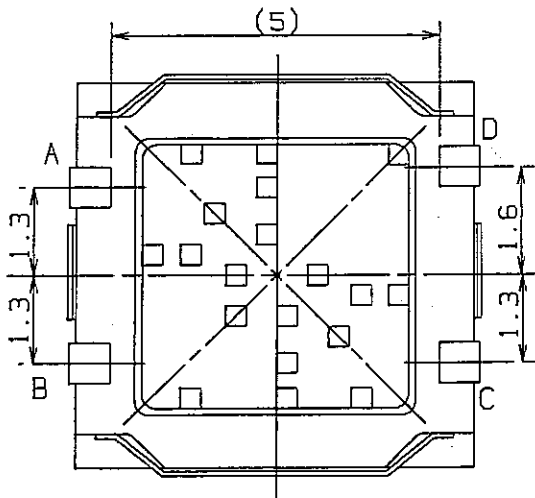
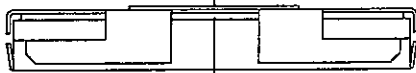
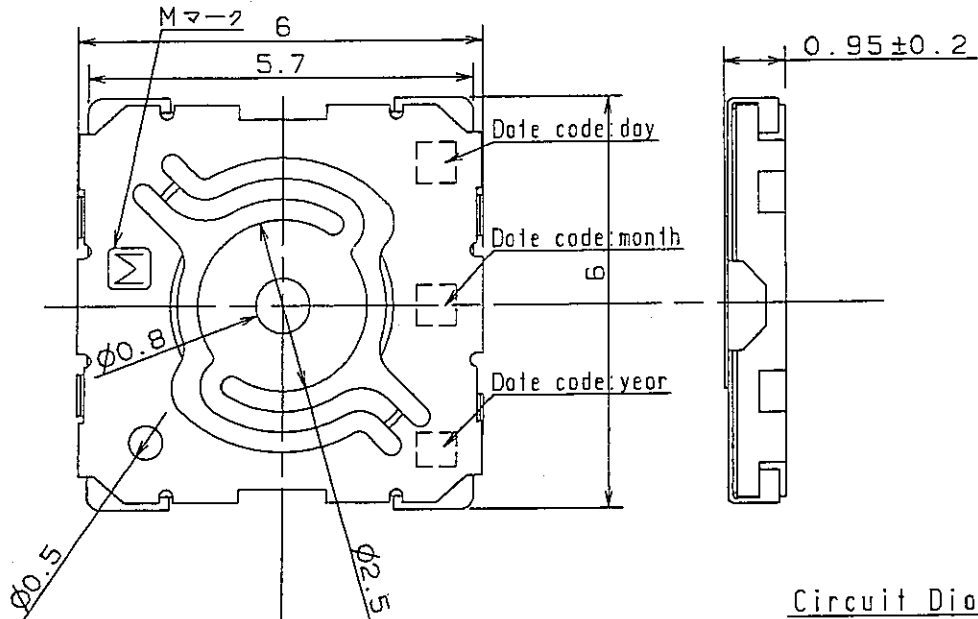

Circuit Diagram

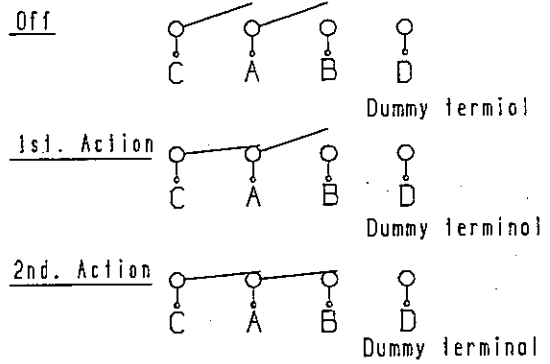

Lead pattern plan

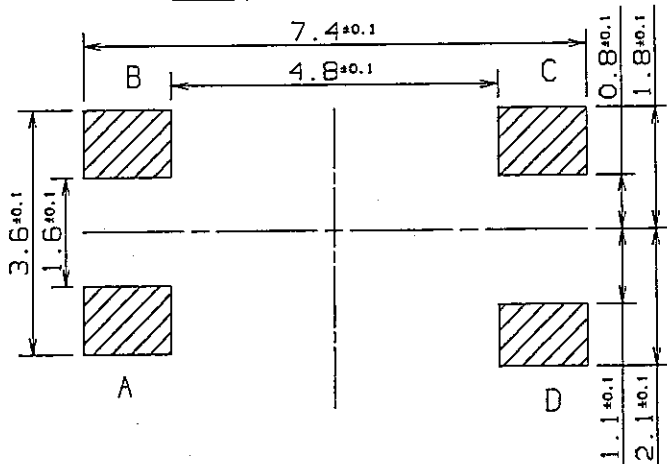

DESIGN	K. Kawanishi	Feb. 25.03	NAME			
DRAW			LIGHT TOUCH SWITCH	ISSUE	REVISIONS	DATE
CHECK	M. Watanabe	Feb. 25.03	TYPE NO.	DRAWING NO.		
APPROVAL	M. Watanabe	Feb. 25.03	EVQ PR3 A10	RV-H-REFERENCE ONLY 1 / 9		

1. General specification

- 1.1 Switch action : Push-ON type S.P.S.T.
- 1.2 Switch rating : D.C. 15V 20mA ~ D.C. 2V 10 $\mu$ A
- 1.3 Operation temperature range : -20 ~ +70 $^{\circ}$ C
- 1.4 Preservative temperature range : Single condition : -40 ~ +85 $^{\circ}$ C  
Taping condition : -20 ~ +60 $^{\circ}$ C
- 1.5 Appearance and dimensions : See outside drawing page.

1.6 Standard conditions Unless otherwise specified, the test and measurements shall be carried out as follows:

- Ambient temperature : 5 ~ 35 $^{\circ}$ C
- Relative humidity : 45 ~ 85%
- Air pressure : 86 ~ 106kPa

However, if doubt arises on the decision based on the measured values under the above-mentioned conditions, the following conditions shall be employed.

- Ambient temperature : 20 $\pm$ 2 $^{\circ}$ C
- Relative humidity : 65 $\pm$ 5%
- Air pressure : 86 ~ 106kPa

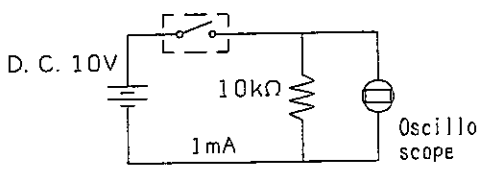

2. Performance

2.1 Electrical characteristics

No.	ITEM	TEST CONDITION	PERFORMANCE
2.1.1	Contact resistance	Push force :  Operation force  $\times$ 2 Measurement tool : Contact resistance meter (1kHz, 20mV, 5~50mA)	100m $\Omega$ max.
2.1.2	Insulation resistance	D.C. 100V (Between terminals)	50M $\Omega$ min.
2.1.3	Withstand voltage	A.C. 100V for 1 minute. (Between terminals)	No insulation destruction
2.1.4	Bouncing	Operation speed : 3~4 times/s  	ON : 3ms max. OFF : 20ms max.

NAME LIGHT TOUCH SWITCH	ISSUE	REVISIONS	DATE
	DRAWING NO. RV-H- REFERENCE ONLY		
TYPE NO. EVQ PR3 A10			2 / 9

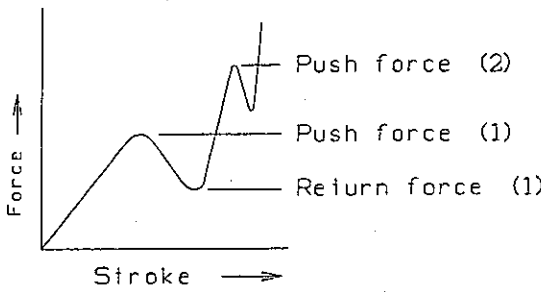
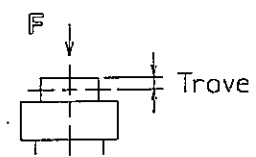
2.2 Mechanical characteristics

No.	ITEM	TEST CONDITION	PERFORMANCE
2.2.1	Operation force	Push by recommended operating condition. (4.2) 	Push force(1) $0.7 \pm 0.4 \text{ N}$ Push force: (2) $2.6 \begin{matrix} +0.5 \\ -0.7 \end{matrix} \text{ N}$
2.2.2	Travel to closure	Push by recommended operating condition. (4.2) $F =  \text{Operation force}  \times 2$ 	Stroke(1) $0.35 \pm 0.15 \text{ mm}$ Stroke(2) $0.55 \pm 0.15 \text{ mm}$
2.2.3	Push strength	20N for 15 sec. 	No damage (Electrical and mechanical)
		50N for 15 sec. 	Variation rate of Push force shall be within $\pm 30\%$ to the value before testing.
2.2.4	Vibration test	1) Amplitude : 1.5mm 2) Sweep rate : 10-55-10Hz for 1 minute 3) Sweep method : Logarithmic frequency sweep rate 4) Vibration direction : X,Y,Z (3 directions) 5) Time : Each direction 2 hours (Total 6 hours)	No.2.1 and 2.2.1 to 2.2.2 shall be satisfied.
2.2.5	Soldering heat test	Mount the switch on P.W.B. by adhesive. 1) Reflow process one time. (Refer to section 4.1) 2) Standard conditions after test : 24 hours	Contact resistance 200 mΩ max. No.2.1.2 to 2.1.4 and No.2.2.1 to 2.2.2 shall be satisfied.
2.2.6	Solderbility	After sprated flux. temperature : $230 \pm 5^\circ \text{C}$ Soldering time : $2 \pm 0.5 \text{ sec.}$	70% or more of surface area of the portion immersed in solder shall be covered by new solder.

NAME	LIGHT TOUCH SWITCH		
	ISSUE	REVISIONS	DATE
TYPE NO.	EVQ PR3 A10		DRAWING NO.
			RV-H- REFERENCE ONLY
			3 / 9

2.3 Climatic characteristics

No.	ITEM	TEST CONDITION	PERFORMANCE												
2.3.1	Cold test	1) Temperature : $-40\pm 2^{\circ}\text{C}$ 2) Duration of test : 500 h 3) Take off a drop water. 4) Standard conditions after test : 1 h	Contact resistance 200 mΩ max. No.2.1.2 to 2.1.4 and No.2.2.1 to 2.2.2 shall be satisfied.												
2.3.2	Heat test	1) Temperature : $85\pm 2^{\circ}\text{C}$ 2) Duration of test : 500 h 3) Standard conditions after test : 1 h	Contact resistance 200 mΩ max. No.2.1.2 to 2.1.4 and No.2.2.1 to 2.2.2 shall be satisfied.												
2.3.3	Temperature cycle	1) Test cycles : 20 cycles 2) Standard conditions after test : 1 h <table border="1" style="margin-left: 40px;"> <thead> <tr> <th></th> <th>Temperature</th> <th>Duration of test</th> </tr> </thead> <tbody> <tr> <td rowspan="4" style="writing-mode: vertical-rl; transform: rotate(180deg);">1 cycle</td> <td><math>20\pm 5^{\circ}\text{C}</math></td> <td>2~3min.</td> </tr> <tr> <td><math>-40\pm 2^{\circ}\text{C}</math></td> <td>1 h</td> </tr> <tr> <td><math>20\pm 5^{\circ}\text{C}</math></td> <td>2~3min.</td> </tr> <tr> <td><math>85\pm 2^{\circ}\text{C}</math></td> <td>1 h</td> </tr> </tbody> </table>		Temperature	Duration of test	1 cycle	$20\pm 5^{\circ}\text{C}$	2~3min.	$-40\pm 2^{\circ}\text{C}$	1 h	$20\pm 5^{\circ}\text{C}$	2~3min.	$85\pm 2^{\circ}\text{C}$	1 h	Contact resistance 200 mΩ max. No.2.1.2 to 2.1.4 and No.2.2.1 to 2.2.2 shall be satisfied.
	Temperature	Duration of test													
1 cycle	$20\pm 5^{\circ}\text{C}$	2~3min.													
	$-40\pm 2^{\circ}\text{C}$	1 h													
	$20\pm 5^{\circ}\text{C}$	2~3min.													
	$85\pm 2^{\circ}\text{C}$	1 h													
2.3.4	Humidity test	1) Temperature : $60\pm 2^{\circ}\text{C}$ 2) Relative humidity : 90~95% 3) Duration of test : 500 h 4) Take off a drop water. 5) Standard conditions after test : 1 h	Contact resistance 200 mΩ max. No.2.1.2 to 2.1.4 and No.2.2.1 to 2.2.2 shall be satisfied.												
2.3.5	Endurance (Switching action)	1) D.C.15V 20mA Resistance load 2) Operation speed : 2~3 times/s 3) Push force : Maximum value of operation force 4) Operation number : 30,000 times	Contact resistance 10 Ω max. Bouncing : 20 ms max. Variation rate of operation force shall be within $\pm 30\%$ to the value before testing. No.2.1.2 and 2.2.2 shall be satisfied.												
2.3.6	Withstand H <sub>2</sub> S	1) Density : $3\pm 1$ ppm 2) Temperature : $40\pm 2^{\circ}\text{C}$ 3) Relative humidity : 80% 4) Duration of test : 24 h 5) Standard conditions after test : 1 h	Contact resistance 200 mΩ max. No.2.1.2 to 2.1.4 and No.2.2.1 to 2.2.2 shall be satisfied.												

NAME	LIGHT TOUCH SWITCH	ISSUE	REVISIONS	DATE
		DRAWING NO.		
TYPE NO.	EVQ PR3 A10	RV-H- REFERENCE ONLY		4 / 9

3. Marking Our identification mark (M) or M, Date code

4. Attentions Required for Use

In order to prevent accidents or performance deteriorations in use of the product, observe the following restrictions and pay attentions to the following items.

[Restrictions]

- 1) When this product is soldered by solder bath dwelling (Flow soldering) method, it may damage performance of this product. Therefore, be sure to perform soldering by reflow method.
- 2) Cleaning after soldering is not allowed when cleaning is required necessarily, after-fitted should be conducted.

4.1 Reflow soldering conditions

1) Therefore, be sure to perform soldering by following reflow temperature profile.

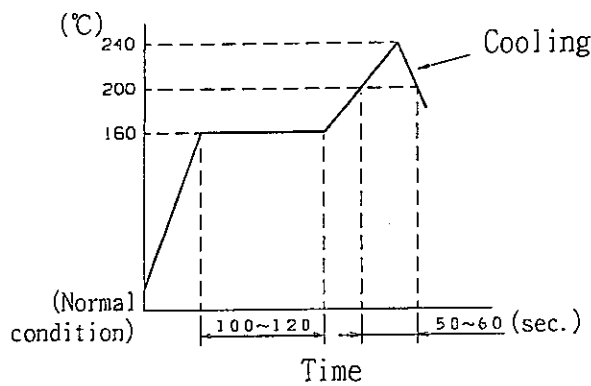

- 2) In the process of re-work the power of iron solder should be less than 20 watts and soldering condition should be as follows, Temperature : 280°C max., Period : 3 seconds max.

3) Do not put any object such as a weight etc. on the operating knob.

4.2 Attentions Required for Set Design

1) When the soldering land pattern is to be designed, design with the recommended land pattern and dimensions described in this Specifications for Information.

2) Design the operating section on the setting side as shown in the Fig-1.

Inclination shall be within 4 degree. (Refer to the Fig-2)

(In case of using elastic materials such as rubber for the button or actuator on the set, this product would have possibility not to work properly due to excessive slanted actuator.)

The switch and the decentering shall be 0.3mm max..

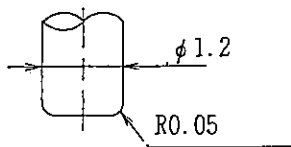

fig-1

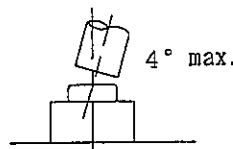

fig-2

NAME LIGHT TOUCH SWITCH	ISSUE	REVISIONS	DATE
	DRAWING NO. RV-H- REFERENCE ONLY		
TYPE NO. EVQ PR3 A10			5 / 9



#### 4.3 Attentions Required for Other Items

- 1) Do not apply excessive load to this product.  
Pay special attention to the terminal section.  
It may be a cause of terminal deformation, bad contact, or malfunction.
- 2) To prevent a bad contact caused by foreign particles (dust particles of P.W.B., dust particles of flux) into the inside of the switch, pay attention to handle the P.C.B. after mounting.  
And do not pile up the P.C.B..
- 3) Avoid pressing the rubber portion of the product with sharp-edged object.
- 4) Please take your attention for amount of solder paste and soldering condition because the switch would be damaged if a flux comes into the switch and extra amount of solder paste is mounted as out of our recommendation.
- 5) This switch is for making a momentary signal in your application as human touch device between your finger and a unit. Therefore, prohibiting using this switch under the condition that you may expect this is put on making(closing) for long term after actuated.

#### 4.4 Attentions Required for Circuit Condition

##### 4.4.1 Rating

- (1) In order to assure the reliability, use this product within the rating range specified in the Specifications for Information.
- (2) Rated power is a maximum value of the power which can be continuous load at rated ambient temperature.
- (3) If the product is used over the rated power, the correct characteristics may not be gained or the product may be damaged by a fire.
- (4) The circuit shall be designed to avoid the inrush current in the switch.  
And avoid the surge voltage to be applied.
- (5) When the switches is to be used with the order (dry circuit) under a few  $\mu A$ , contact resistance may affect on it because of its structure of circuit, so please check the operationg conditions.
- (6) Do not apply the voltage of rated puncture value min. between the insulation and the electrode.

##### 4.4.2 Attentions Required for Bouncing and Chattering

In order to prevent the malfunction by chattering caused by bouncing at switch-operation of ON/OFF and external vibration etc., please pay attention to the design shown below.

- 1) Read several times.
- 2) Set the delay time.
- 3) Set the CR integration circuit.

NAME	LIGHT TOUCH SWITCH	ISSUE	REVISIONS	DATE
TYPE NO.	EVQ PR3 A10	DRAWING NO.		
		RV-H- REFERENCE ONLY		6 / 9



#### 4.5 Attentions Required for Mounting and Operating condition

##### 4.5.1 Operating temperature

In order to assure the reliability, use this product within the operating temperature range specified in the Specifications for Information.

##### 4.5.2 Operating relative humidity

Do not use this product under relative humidity of 85% min. for a long time.  
(Except for the product considered the countermeasure)

Avoid using this product in a place where it is directly exposed to the wheather, or where humidity is high caused by steam and dew condensation, etc.

##### 4.5.3 This product is not a sealed type.

Avoid the use under following circumstances and conditions as it may affect a bad influence to characteristics.

- (1) In the corrosive gas atmosphere, such as Cl<sub>2</sub>, H<sub>2</sub>S, NH<sub>3</sub>, NO<sub>x</sub>, SO<sub>2</sub> gas.
- (2) Waterdrop remained, dew condensation, Waterdrop adhered.
- (3) In the solution of water, salt water, oil, chemicals, and organic solvents.
- (4) A place where it is exposed to direct sunlight.
- (5) A place with large amounts of dust or dirt particles.

##### 4.5.4 The structure of this product is not waterproof, chemicals resistance and solvent resistance. Do not wet with water, chemicals and/or solvents.

##### 4.5.5 Do not apply the vibration, the shock (drop, etc.) or the pressure to this product more than specified.

##### 4.5.6 Push strength

In order to avoid damages of the switch, do not apply the load to the operating section more than specified.

(If the load is applied more than specified, it may affect on the characteristics of the push stroke, etc.)

##### 4.5.7 Avoid the use of the switch under pushed ON condition is continued for a long time.

#### 4.6 Repair Service

##### 4.6.1 When additional solder to the mounting soldering section of this product is to be performed or soldering section is to be removed, pay attention not to apply excessive stress and the temperature.

##### 4.6.2 Pay attention not to melt the insulation material or the resin section, and avoid remarkable deformation.

NAME LIGHT TOUCH SWITCH			
	ISSUE	REVISIONS	DATE
TYPE NO. EVQ PR3 A10	DRAWING NO. RV-H- REFERENCE ONLY		7 / 9

Carrier tape

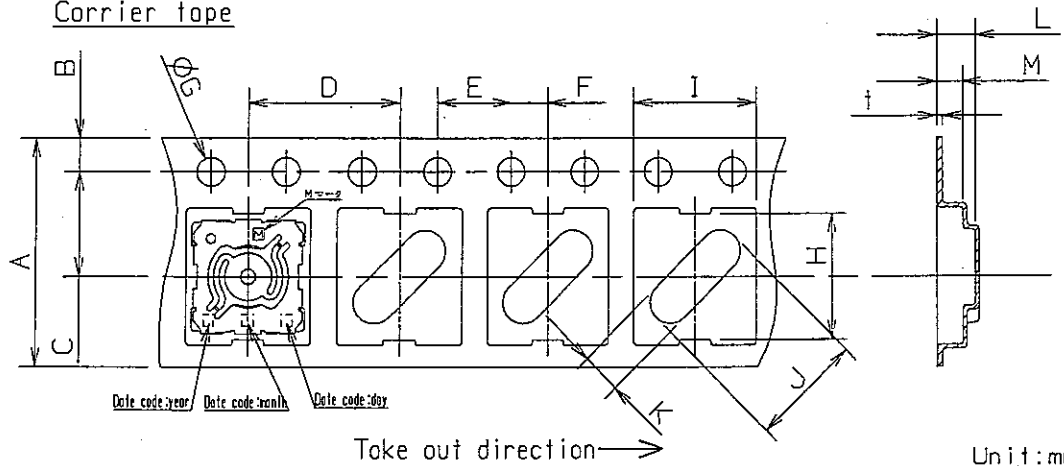

A	B	C	D	E	F	G	H	I	J	K	L	M	t
$\pm 0.3$	$\pm 0.15$	$\pm 0.15$	$\pm 0.15$	$\pm 0.15$	$\pm 0.15$	$\pm 0.1$	$\pm 0.3$	$\pm 0.3$	$\pm 0.3$	$\pm 0.2$	$\pm 0.3$	$\pm 0.05$	$\pm 0.05$
12	1.75	5.5	8	4	2	1.5	6.3	6.3	6	2	1.7	1	0.3

Taping condition : Lack of products should not continue 2pcs.

Top tape(sheet tape)strip strength : 0.3 to 1.0N  
(Strip angle :165°)

Reel(5000pcs./reel)

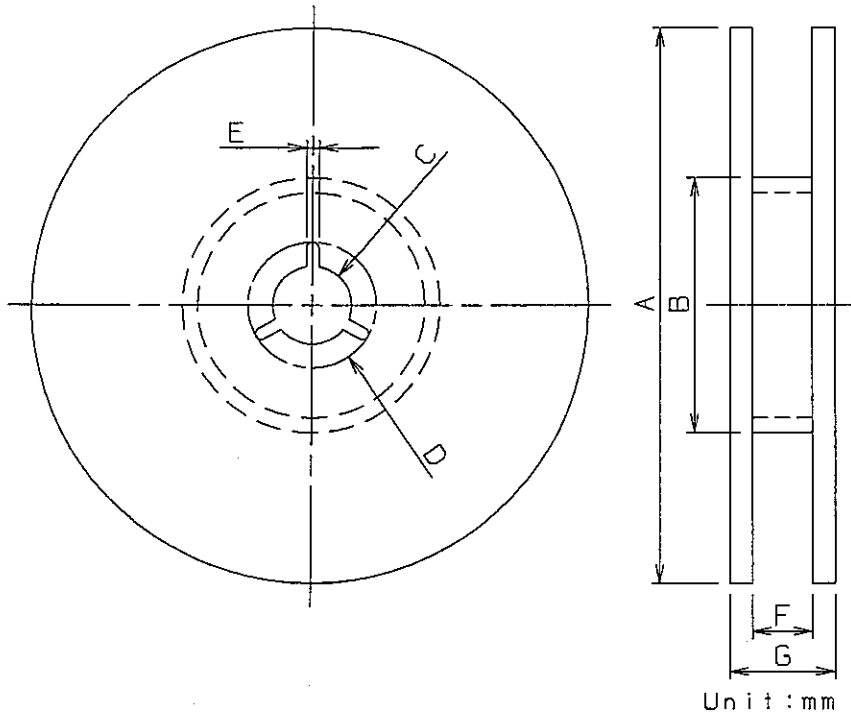

A	B	C	D	E	F	G
$\pm 2$	$\pm 1$	$\pm 0.5$	$\pm 1$	$\pm 0.5$	$\pm 1$	$\pm 1$
$\phi 380$	$\phi 80$	$\phi 13$	$\phi 21$	2	13.5	17.5

NAME	LIGHT TOUCH SWITCH	ISSUE	REVISIONS	DATE
TYPE NO.	EVQ PR3 A10	DRAWING NO.	RV-H- REFERENCE ONLY	8 / 9

Prohibitions and precautions for handling.

1) Prohibited items on fire and smoking

- . Absolutely avoid use of a switch beyond its rated range because doing so may cause a fire. If misuse or abnormal use may result in conditions in which the potentiometer is used out of its rated range, take proper measures such as current interruption using a protective circuit.
- . The grade of nonflammability for resin used in Light Touch Switches is "94HB," which is based on UL94 Standards (flammability test for plastic materials). Prohibit use in a location where a spreading fire may be generated or prepare against a spreading fire.

2) For use in equipment for which safety requested

- . Although care is taken to ensure switch quality, inferior characteristics, short circuits, open circuits are some problems that might be generated. To design a set which places maximum emphasis on safety, review the affect of any single fault of a switch in advance and preform virtually fail-safe design to ensure maximum safety by:
  - . Preparing a protective circuit or a protective device to improve system safety, and
  - . Preparing a redundant circuit to improve system safety so that the single fault of a switch does not cause a dangerous situation.

3) Attentions Required for Storage Condition

- . When this product is to be stored in the following circumstances and conditions, it may affect on the performance deteriorations and solderability etc., avoid storing in the following conditions.
  - (1) A place where the temperature is -10 °C max., +40 °C min. and the humidity is 85 % min.
  - (2) In the corrosive gas atmosphere.
  - (3) Long-term storage for 6 months min. after the product is delivered.
  - (4) A place where the product is exposed to direct sunlight.
- . Store in packed condition so that the load stress is not applied.
- . Please use this product as soon as possible, our recommendation is within 3 months and the limitation is 6 months.
- . If any remainder left after packing is opened, store it with proper moisture-proofing and gasproofing, etc..

<Handling of reference spesufication. >

. Since the contents of this reference specification are subjected to change without prior notifications, please request us a formal specification again for your investigations before using.

NAME	LIGHT TOUCH SWITCH	ISSUE	REVISIONS	DATE
TYPE NO.	EVQ PR3 A10	DRAWING NO.		
		RV-H- REFERENCE ONLY		9 / 9