



Chipsmall Limited consists of a professional team with an average of over 10 year of expertise in the distribution of electronic components. Based in Hongkong, we have already established firm and mutual-benefit business relationships with customers from,Europe,America and south Asia,supplying obsolete and hard-to-find components to meet their specific needs.

With the principle of “Quality Parts,Customers Priority,Honest Operation,and Considerate Service”,our business mainly focus on the distribution of electronic components. Line cards we deal with include Microchip,ALPS,ROHM,Xilinx,Pulse,ON,Everlight and Freescale. Main products comprise IC,Modules,Potentiometer,IC Socket,Relay,Connector.Our parts cover such applications as commercial,industrial, and automotives areas.

We are looking forward to setting up business relationship with you and hope to provide you with the best service and solution. Let us make a better world for our industry!



Contact us

Tel: +86-755-8981 8866 Fax: +86-755-8427 6832

Email & Skype: info@chipsmall.com Web: www.chipsmall.com

Address: A1208, Overseas Decoration Building, #122 Zhenhua RD., Futian, Shenzhen, China



6 mm Square Long Travel 2R Light Touch Switches

Type: **EVQPV**

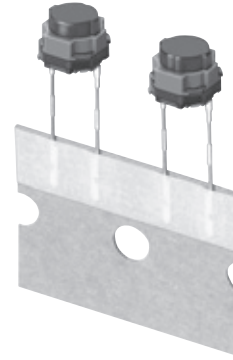

■ Features

- External dimensions : 6.0 mm×6.1 mm, Height 5.0 mm
(Including the push plate)
- High mountability, section terminals and radial taping package
- Low contact resistance and steady contact characteristics

■ Recommended Applications

- Operating switches for car electronic equipment.
- Input on operating switches for telephones, electronic musical instruments, etc.

■ Explanation of Part Numbers

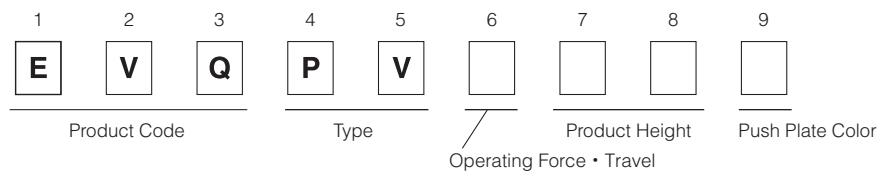

■ Specifications

Type	Snap action/Push-on type SPST	
Electrical	Rating	10 μ A 2 V DC to 50 mA 12 V DC (Resistive load)
	Contact Resistance	100 m Ω max.
	Insulation Resistance	100 M Ω min. (at 100 V DC)
	Dielectric Withstanding Voltage	250 V AC for 1 minute
	Bouncing	10 ms max. (ON, OFF)
Mechanical	Operating Force	2.2 N 1.6 N, 2.0 N, 2.5 N, 3.5 N
	Travel	1.0 mm \pm 0.2 mm 1.3 mm \pm 0.2 mm
Endurance	Operating Life	100,000 cycles min. (3.5 N type : 30,000 cycles min.)
Operating Temperature		-30 °C to +85 °C
Storage Temperature		-40 °C to +85 °C (Bulk) -20 °C to +40 °C (Taping)
Minimum Quantity/Packing Unit		2,500 pcs. Radial Taping (Reel Pack)
Quantity/Carton		25,000 pcs.

Design and specifications are each subject to change without notice. Ask factory for the current technical specifications before purchase and/or use.
Should a safety concern arise regarding this product, please be sure to contact us immediately.

■ Dimensions in mm (not to scale)

EVQPV

General dimension tolerance : ± 0.2
() dimensions are reference dimensions.

(Radial Taping)

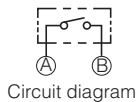
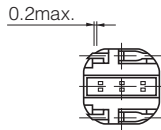
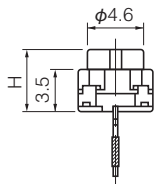
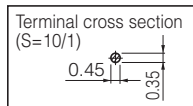
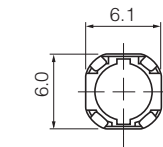

The direction of (a) or (b) side is randomly settled.

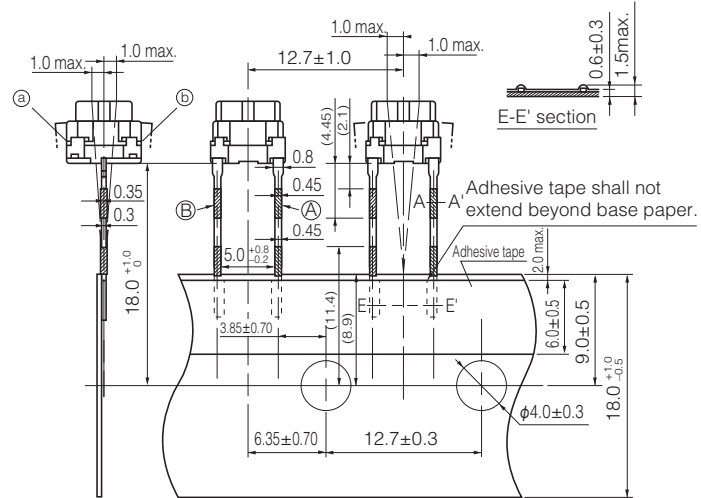

JIS C0806-2 shall be applied for the items not specified here.

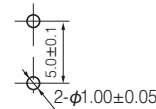

PWB mounting hole for reference
View from mounting side

Part Numbers	Operating Force	Travel	H=Height	Push Plate Color	Operating Life
EVQPVA05K	2.2 N	1.0 mm	5.0 mm	Black	100,000 cycles
EVQPV205K	1.6 N	1.3 mm	5.0 mm	Black	100,000 cycles
EVQPVG05K	2.0 N	1.3 mm	5.0 mm	Black	100,000 cycles
EVQPVF05K	2.5 N	1.3 mm	5.0 mm	Black	100,000 cycles
EVQPVW05K	3.5 N	1.3 mm	5.0 mm	Black	30,000 cycles

Design and specifications are each subject to change without notice. Ask factory for the current technical specifications before purchase and/or use.
Should a safety concern arise regarding this product, please be sure to contact us immediately.