



Chipsmall Limited consists of a professional team with an average of over 10 year of expertise in the distribution of electronic components. Based in Hongkong, we have already established firm and mutual-benefit business relationships with customers from,Europe,America and south Asia,supplying obsolete and hard-to-find components to meet their specific needs.

With the principle of “Quality Parts,Customers Priority,Honest Operation,and Considerate Service”,our business mainly focus on the distribution of electronic components. Line cards we deal with include Microchip,ALPS,ROHM,Xilinx,Pulse,ON,Everlight and Freescale. Main products comprise IC,Modules,Potentiometer,IC Socket,Relay,Connector.Our parts cover such applications as commercial,industrial, and automotives areas.

We are looking forward to setting up business relationship with you and hope to provide you with the best service and solution. Let us make a better world for our industry!



Contact us

Tel: +86-755-8981 8866 Fax: +86-755-8427 6832

Email & Skype: info@chipsmall.com Web: www.chipsmall.com

Address: A1208, Overseas Decoration Building, #122 Zhenhua RD., Futian, Shenzhen, China





Thermal Management Solutions CONTENTS

Product Item	Part Number	Page
Multilayer NTC Thermistors	The NTC Thermistors	2
	ERT JZ ERT J0 ERT J1	3
	Handling Precautions	11
Multilayer NTC Thermistors (Automotive Grade)	ERT J0 M ERT J1 M	16
	Handling Precautions	21
"PGS" Graphite Sheets SSM(Semi-Sealing Material)	EYG S EYG A EYG E	26
	Minimum order	32
	Handling Precautions	34
"NASBIS" Insulating Sheet	EYG Y EYG N	35
	Handling Precautions	38
"Graphite-PAD" high thermal conductivity in z-direction	EYG T	39
	Handling Precautions	42
"Soft-PGS (Compressible Type)" PGS with low thermal resistance	EYG S	43
	Handling Precautions	47

All products in this catalog comply with the RoHS Directive.

The RoHS Directive is "the Directive (2011/65/EU) on the Restriction of the Use of Certain Hazardous Substances in Electrical and Electronic Equipment " and its revisions.

The NTC Thermistors

NTC Thermistors is a negative temperature coefficient resistor that significantly reduces its resistance value as the heat/ ambient temperature rises. Thermistors is sintered in high-temperature (1200 °C to 1500 °C), and manufactured in various shapes. It's comprised of 2 to 4 kinds of metal oxides: iron, nickel, cobalt, manganese and copper.

Features

- Temperature Coefficient of Resistance is negative, and it's extremely large (-2.8 to -5.1 [%/°C]).
- Various shapes, especially compact size components are available.
- Selection of resistance value is comparatively free, it's available from several tens Ω to several hundred kΩ.

Recommended Applications

- For temperature measurement or temperature detection : Thermometer, temperature controller
- For temperature compensation : Transistor, transistor circuit, quartz oscillation circuit, and measuring instruments

Physical Characteristics of NTC Thermistors

Thermistor is a resistor sensitive to temperature that is utilizing the characteristic of metal oxide semiconductor having large temperature coefficient. And its temperature dependency of resistance value is indicated by the following equation :

$$R=R_0 \exp \left[B \left(\frac{1}{T} - \frac{1}{T_0} \right) \right] \dots\dots\dots(1)$$

T_0 : Standard Temperature 298.15 K(25 °C)
 R_0 : Resistance at T_0 [K]
 B : Thermistor Constant [K]

Temperature coefficient (α) in general meaning is indicated as follows :

$$\alpha = -\frac{B}{T^2} \dots\dots\dots(2)$$

Since the change by temperature is considerably large, α is not appropriate as a constant. Therefore, B value (constant) is generally used as a coefficient of thermistors.

Major Characteristics of NTC Thermistors

The relation between resistance and temperature of a thermistor is linear as shown in Fig. 2. The resistance value is shown in vertical direction in a logarithmic scale and reciprocal of absolute temperature (adding 273.15 to centigrade) is shown in horizontal direction.

The B value (constant) determines the gradient of these straight lines. The B value (constant) is calculated by using following equation.

$$B = \frac{\ln R_1 - \ln R_2}{\frac{1}{T_1} - \frac{1}{T_2}} \dots\dots\dots(3)$$

R_1 : Resistance at T_1 K
 R_2 : Resistance at T_2 K

When you calculate this equation, you'll find that B value is not exactly constant. The resistance is expressed by the following equation :

$$R = AT^{-C} \exp D/T \dots\dots\dots(4)$$

In (4), C is a small positive or negative constant and quite negligible except for use in precision temperature-measuring device, therefore, the B value can be considered as constant number.

In Fig. 1, the relation between the resistance ratio R_T/R_{25} (R_{25} : Resistance at 25 °C, R_T : Resistance at T °C) and B Value is shown with T °C, in the horizontal direction.

Fig. 1

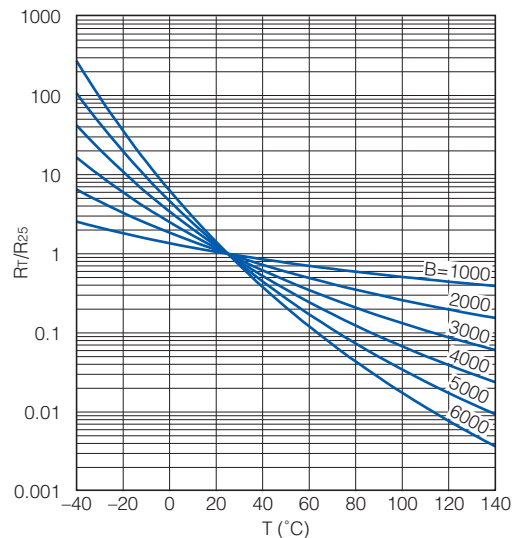
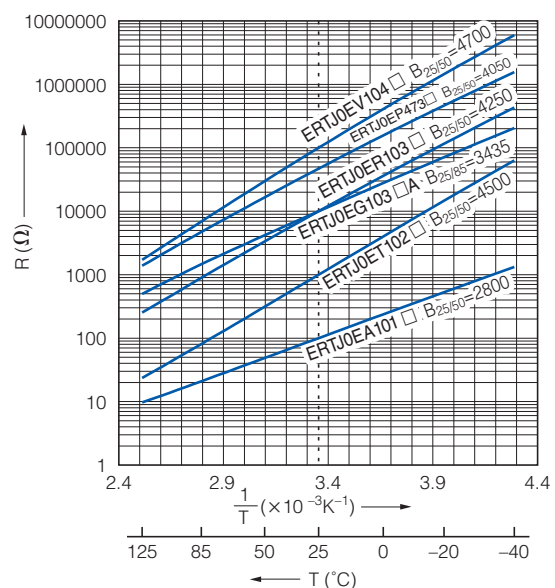
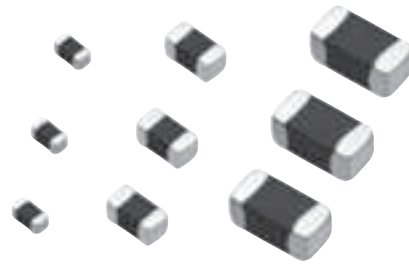

Fig. 2



Multilayer NTC Thermistors

Series: **ERTJ**



Features

- Surface Mount Device (0201, 0402, 0603)
- Highly reliable multilayer / monolithic structure
- Wide temperature operating range (-40 to 125 °C)
- Environmentally-friendly lead-free
- RoHS compliant

Recommended Applications

- Mobile Phone
 - Temperature compensation for crystal oscillator
 - Temperature compensation for semiconductor devices
- Personal Computer and Peripheral Device
 - Temperature detection for CPU and memory device
 - Temperature compensation for ink-viscosity (Inkjet Printer)
- Battery Pack (secondary battery)
 - Temperature detection of battery cells
- Liquid Crystal Display
 - Temperature compensation of display contrast
 - Temperature compensation of display backlighting (CCFL)

Explanation of Part Numbers

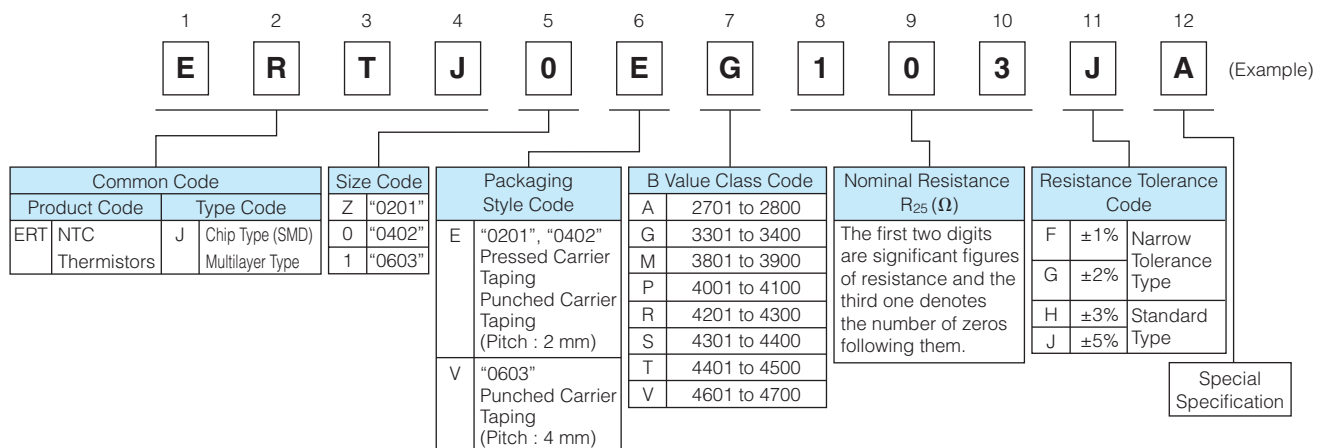

Construction

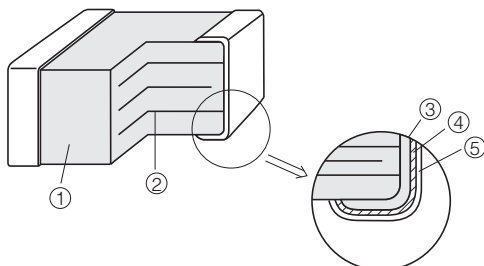

No.	Name	
①	Semiconductive Ceramics	
②	Internal electrode	
③	Terminal electrode	Substrate electrode
④		Intermediate electrode
⑤		External electrode

Ratings

Size code (EIA)	Z(0201)	O(0402)	1(0603)
Operating Temperature Range	-40 to 125 °C		
Rated Maximum Power Dissipation*1	33 mW	66 mW	100 mW
Dissipation Factor*2	Approximately 1 mW/°C	Approximately 2 mW/°C	Approximately 3 mW/°C

- *1 Rated Maximum Power Dissipation : The maximum power that can be continuously applied at the rated ambient temperature.
 ·The maximum value of power, and rated power is same under the condition of ambient temperature 25 °C or less. If the temperature exceeds 25 °C, rated power depends on the decreased power dissipation curve.
 ·Please see "Operating Power" for details.
- *2 Dissipation factor : The constant amount power required to raise the temperature of the Thermistor 1 °C through self heat generation under stable temperatures.
 ·Dissipation factor is the reference value when mounted on a glass epoxy board (1.6 mmT).

Part Number List of Narrow Tolerance Type (Resistance Tolerance : ±2 %, ±1 %)

● 0201(EIA)

Part Number	Nominal Resistance at 25 °C	Resistance Tolerance	B Value at 25/50(K)	B Value at 25/85(K)
ERTJZEG103□A	10 kΩ	±1 % (F) or ±2 % (G)	(3380 K)	3435 K±1%
ERTJZEP473□	47 kΩ		4050 K±1 %	(4100 K)
ERTJZEP683□	68 kΩ		4050 K±1 %	(4100 K)
ERTJZER683□	68 kΩ		4250 K±1 %	(4300 K)
ERTJZER104□	100 kΩ		4250 K±1 %	(4300 K)
ERTJZET104□	100 kΩ		4500 K±1 %	(4550 K)
ERTJZEV104□	100 kΩ		4700 K±1 %	(4750 K)

□ : Resistance Tolerance Code

● 0402(EIA)

Part Number	Nominal Resistance at 25 °C	Resistance Tolerance	B Value at 25/50(K)	B Value at 25/85(K)
ERTJ0EG103□A	10 kΩ	±1 % (F) or ±2 % (G)	(3380 K)	3435 K±1 %
ERTJ0EP333□	33 kΩ		4050 K±1 %	(4100 K)
ERTJ0EP473□	47 kΩ		4050 K±1 %	(4100 K)
ERTJ0EP683□	68 kΩ		4050 K±1 %	(4100 K)
ERTJ0ER104□	100 kΩ		4250 K±1 %	(4300 K)
ERTJ0ES104□	100 kΩ		4330 K±1 %	(4390 K)
ERTJ0EV104□	100 kΩ		4700 K±1 %	(4750 K)
ERTJ0EV224□	220 kΩ		4700 K±1 %	(4750 K)

□ : Resistance Tolerance Code

● 0603(EIA)

Part Number	Nominal Resistance at 25 °C	Resistance Tolerance	B Value at 25/50(K)	B Value at 25/85(K)
ERTJ1VG103□A	10 kΩ	±1 % (F) or ±2 % (G)	(3380 K)	3435 K±1 %
ERTJ1VS104□A	100 kΩ		(4330 K)	4390 K±1 %

□ : Resistance Tolerance Code

Part Number List of Standard Type (Resistance Tolerance : ±5 %, ±3 %)

● 0201(EIA)

Part Number	Nominal Resistance at 25 °C	Resistance Tolerance	B Value at 25/50(K)	B Value at 25/85(K)
ERTJZET202□	2.0 kΩ	±3 % (H) or ±5 % (J)	4500 K±2 %	(4450 K)
ERTJZET302□	3.0 kΩ		4500 K±2 %	(4450 K)
ERTJZET472□	4.7 kΩ		4500 K±2 %	(4450 K)
ERTJZEG103□A	10 kΩ		(3380 K)	3435 K±1 %
ERTJZEP473□	47 kΩ		4050 K±2 %	(4100 K)
ERTJZEP683□	68 kΩ		4050 K±2 %	(4100 K)
ERTJZER683□	68 kΩ		4250 K±2 %	(4300 K)
ERTJZER104□	100 kΩ		4250 K±2 %	(4300 K)
ERTJZET104□	100 kΩ		4500 K±2 %	(4550 K)
ERTJZEV104□	100 kΩ		4700 K±2 %	(4750 K)
ERTJZET154□	150 kΩ		4500 K±2 %	(4750 K)
ERTJZET224□	220 kΩ		4500 K±2 %	(4750 K)

□ : Resistance Tolerance Code

● 0402(EIA)

Part Number	Nominal Resistance at 25 °C	Resistance Tolerance	B Value at 25/50(K)	B Value at 25/85(K)
ERTJ0EA220□	22 Ω	±3 % (H) or ±5 % (J)	2750 K±3 %	(2700 K)
ERTJ0EA330□	33 Ω		2750 K±3 %	(2700 K)
ERTJ0EA400□	40 Ω		2750 K±3 %	(2700 K)
ERTJ0EA470□	47 Ω		2750 K±3 %	(2700 K)
ERTJ0EA680□	68 Ω		2800 K±3 %	(2750 K)
ERTJ0EA101□	100 Ω		2800 K±3 %	(2750 K)
ERTJ0EA151□	150 Ω		2800 K±3 %	(2750 K)
ERTJ0ET102□	1.0 kΩ		4500 K±2 %	(4450 K)
ERTJ0ET152□	1.5 kΩ		4500 K±2 %	(4450 K)
ERTJ0ET202□	2.0 kΩ		4500 K±2 %	(4450 K)
ERTJ0ET222□	2.2 kΩ		4500 K±2 %	(4450 K)
ERTJ0ET302□	3.0 kΩ		4500 K±2 %	(4450 K)
ERTJ0ER332□	3.3 kΩ		4250 K±2 %	(4300 K)
ERTJ0ET332□	3.3 kΩ		4500 K±2 %	(4450 K)
ERTJ0ET472□	4.7 kΩ		4500 K±2 %	(4450 K)
ERTJ0ER472□	4.7 kΩ		4250 K±2 %	(4300 K)
ERTJ0ER682□	6.8 kΩ		4250 K±2 %	(4300 K)
ERTJ0EG103□A	10 kΩ		(3380 K)	3435 K±1 %
ERTJ0EM103□	10 kΩ		3900 K±2 %	(3970 K)
ERTJ0ER103□	10 kΩ		4250 K±2 %	(4300 K)
ERTJ0ER153□	15 kΩ		4250 K±2 %	(4300 K)
ERTJ0ER223□	22 kΩ		4250 K±2 %	(4300 K)
ERTJ0EP333□	33 kΩ		4050 K±2 %	(4100 K)
ERTJ0ER333□	33 kΩ		4250 K±2 %	(4300 K)
ERTJ0ET333□	33 kΩ		4500 K±2 %	(4580 K)
ERTJ0EP473□	47 kΩ		4050 K±2 %	(4100 K)
ERTJ0ET473□	47 kΩ		4500 K±2 %	(4550 K)
ERTJ0EV473□	47 kΩ		4700 K±2 %	(4750 K)
ERTJ0EP683□	68 kΩ		4050 K±2 %	(4100 K)
ERTJ0ER683□	68 kΩ		4250 K±2 %	(4300 K)
ERTJ0EV683□	68 kΩ		4700 K±2 %	(4750 K)
ERTJ0EP104□	100 kΩ		4050 K±2 %	(4100 K)
ERTJ0ER104□	100 kΩ		4250 K±2 %	(4300 K)
ERTJ0ES104□	100 kΩ	4330 K±2 %	(4390 K)	
ERTJ0ET104□	100 kΩ	4500 K±2 %	(4580 K)	
ERTJ0EV104□	100 kΩ	4700 K±2 %	(4750 K)	
ERTJ0ET154□	150 kΩ	4500 K±2 %	(4580 K)	
ERTJ0EV154□	150 kΩ	4700 K±2 %	(4750 K)	
ERTJ0EV224□	220 kΩ	4700 K±2 %	(4750 K)	
ERTJ0EV334□	330 kΩ	4700 K±2 %	(4750 K)	
ERTJ0EV474□	470 kΩ	4700 K±2 %	(4750 K)	

□ : Resistance Tolerance Code

● 0603(EIA)

Part Number	Nominal Resistance at 25 °C	Resistance Tolerance	B Value at 25/50(K)	B Value at 25/85(K)
ERTJ1VA220□	22 Ω	±3 %(H) or ±5 %(J)	2750 K±3 %	(2700 K)
ERTJ1VA330□	33 Ω		2750 K±3 %	(2700 K)
ERTJ1VA400□	40 Ω		2800 K±3 %	(2750 K)
ERTJ1VA470□	47 Ω		2800 K±3 %	(2750 K)
ERTJ1VA680□	68 Ω		2800 K±3 %	(2750 K)
ERTJ1VA101□	100 Ω		2800 K±3 %	(2750 K)
ERTJ1VT102□	1.0 kΩ		4500 K±2 %	(4450 K)
ERTJ1VT152□	1.5 kΩ		4500 K±2 %	(4450 K)
ERTJ1VT202□	2.0 kΩ		4500 K±2 %	(4450 K)
ERTJ1VT222□	2.2 kΩ		4500 K±2 %	(4450 K)
ERTJ1VT302□	3.0 kΩ		4500 K±2 %	(4450 K)
ERTJ1VT332□	3.3 kΩ		4500 K±2 %	(4450 K)
ERTJ1VR332□	3.3 kΩ		4250 K±2 %	(4300 K)
ERTJ1VR472□	4.7 kΩ		4250 K±2 %	(4300 K)
ERTJ1VT472□	4.7 kΩ		4500 K±2 %	(4450 K)
ERTJ1VR682□	6.8 kΩ		4250 K±2 %	(4300 K)
ERTJ1VG103□A	10 kΩ		(3380 K)	3435 K±1%
ERTJ1VR103□	10 kΩ		4250 K±2 %	(4300 K)
ERTJ1VR153□	15 kΩ		4250 K±2 %	(4300 K)
ERTJ1VR223□	22 kΩ		4250 K±2 %	(4300 K)
ERTJ1VR333□	33 kΩ		4250 K±2 %	(4300 K)
ERTJ1VP473□	47 kΩ		4100 K±2 %	(4150 K)
ERTJ1VR473□	47 kΩ		4250 K±2 %	(4300 K)
ERTJ1VV473□	47 kΩ		4700 K±2 %	(4750 K)
ERTJ1VR683□	68 kΩ		4250 K±2 %	(4300 K)
ERTJ1VV683□	68 kΩ		4700 K±2 %	(4750 K)
ERTJ1VS104□A	100 kΩ		(4330 K)	4390 K±1%
ERTJ1VV104□	100 kΩ		4700 K±2 %	(4750 K)
ERTJ1VV154□	150 kΩ		4700 K±2 %	(4750 K)
ERTJ1VT224□	220 kΩ		4500 K±2 %	(4580 K)

□ : Resistance Tolerance Code

● Temperature and Resistance value (the resistance value at 25 °C is set to 1)/ Reference values

	ERTJ□□A~		ERTJ□□G~		ERTJ□□M~		ERTJ□□P~		ERTJ□□R~		ERTJ0ES~		ERTJ1VS~		ERTJ□□T~		ERTJ□□T~		ERTJ□□V~		
B _{25/50}	2750 K	2800 K	(3375 K)	3900 K	4050 K	4250 K	4330 K	(4330 K)	4500 K	4500 K	4700 K										
B _{25/85}	(2700 K)	(2750 K)	3435 K	(3970 K)	(4100 K)	(4300 K)	(4390 K)	4390 K	(4450 K)	(4580 K)	(4750 K)										
T(°C)															*1	*2					
-40	13.05	13.28	20.52	32.11	33.10	43.10	45.67	45.53	63.30	47.07	59.76										
-35	10.21	10.40	15.48	23.29	24.03	30.45	32.08	31.99	42.92	33.31	41.10										
-30	8.061	8.214	11.79	17.08	17.63	21.76	22.80	22.74	29.50	23.80	28.61										
-25	6.427	6.547	9.069	12.65	13.06	15.73	16.39	16.35	20.53	17.16	20.14										
-20	5.168	5.261	7.037	9.465	9.761	11.48	11.91	11.89	14.46	12.49	14.33										
-15	4.191	4.261	5.507	7.147	7.362	8.466	8.743	8.727	10.30	9.159	10.31										
-10	3.424	3.476	4.344	5.444	5.599	6.300	6.479	6.469	7.407	6.772	7.482										
-5	2.819	2.856	3.453	4.181	4.291	4.730	4.845	4.839	5.388	5.046	5.481										
0	2.336	2.362	2.764	3.237	3.312	3.582	3.654	3.650	3.966	3.789	4.050										
5	1.948	1.966	2.227	2.524	2.574	2.734	2.778	2.776	2.953	2.864	3.015										
10	1.635	1.646	1.806	1.981	2.013	2.102	2.128	2.126	2.221	2.179	2.262										
15	1.380	1.386	1.474	1.567	1.584	1.629	1.642	1.641	1.687	1.669	1.710										
20	1.171	1.174	1.211	1.247	1.255	1.272	1.277	1.276	1.293	1.287	1.303										
25	1	1	1	1	1	1	1	1	1	1	1										
30	0.8585	0.8565	0.8309	0.8072	0.8016	0.7921	0.7888	0.7890	0.7799	0.7823	0.7734										
35	0.7407	0.7372	0.6941	0.6556	0.6461	0.6315	0.6263	0.6266	0.6131	0.6158	0.6023										
40	0.6422	0.6376	0.5828	0.5356	0.5235	0.5067	0.5004	0.5007	0.4856	0.4876	0.4721										
45	0.5595	0.5541	0.4916	0.4401	0.4266	0.4090	0.4022	0.4025	0.3874	0.3884	0.3723										
50	0.4899	0.4836	0.4165	0.3635	0.3496	0.3319	0.3251	0.3254	0.3111	0.3111	0.2954										
55	0.4309	0.4238	0.3543	0.3018	0.2881	0.2709	0.2642	0.2645	0.2513	0.2504	0.2356										
60	0.3806	0.3730	0.3027	0.2518	0.2386	0.2222	0.2158	0.2161	0.2042	0.2026	0.1889										
65	0.3376	0.3295	0.2595	0.2111	0.1985	0.1832	0.1772	0.1774	0.1670	0.1648	0.1523										
70	0.3008	0.2922	0.2233	0.1777	0.1659	0.1518	0.1463	0.1465	0.1377	0.1348	0.1236										
75	0.2691	0.2600	0.1929	0.1504	0.1393	0.1264	0.1213	0.1215	0.1144	0.1108	0.1009										
80	0.2417	0.2322	0.1672	0.1278	0.1174	0.1057	0.1011	0.1013	0.09560	0.09162	0.08284										
85	0.2180	0.2081	0.1451	0.1090	0.09937	0.08873	0.08469	0.08486	0.08033	0.07609	0.06834										
90	0.1974	0.1871	0.1261	0.09310	0.08442	0.07468	0.07122	0.07138	0.06782	0.06345	0.05662										
95	0.1793	0.1688	0.1097	0.07980	0.07200	0.06307	0.06014	0.06028	0.05753	0.05314	0.04712										
100	0.1636	0.1528	0.09563	0.06871	0.06166	0.05353	0.05099	0.05112	0.04903	0.04472	0.03939										
105	0.1498	0.1387	0.08357	0.05947	0.05306	0.04568	0.04340	0.04351	0.04198	0.03784	0.03308										
110	0.1377	0.1263	0.07317	0.05170	0.04587	0.03918	0.03708	0.03718	0.03609	0.03218	0.02791										
115	0.1270	0.1153	0.06421	0.04512	0.03979	0.03374	0.03179	0.03188	0.03117	0.02748	0.02364										
120	0.1175	0.1056	0.05650	0.03951	0.03460	0.02916	0.02734	0.02742	0.02702	0.02352	0.02009										
125	0.1091	0.09695	0.04986	0.03470	0.03013	0.02527	0.02359	0.02367	0.02351	0.02017	0.01712										

*1 Apply to products with a B_{25/50} constant of 4500 K and a resistance value of 25 °C less than 10 kΩ. *2 Applied only to ERTJ0ET104□.

*2 Apply to products with a B_{25/50} constant of 4500 K and a resistance value of 25 °C of 10 kΩ or more. *2 Applied only to ERTJ0ET104□.

$$B_{25/50} = \frac{\ln(R_{25}/R_{50})}{1/298.15 - 1/323.15}$$

$$B_{25/85} = \frac{\ln(R_{25}/R_{85})}{1/298.15 - 1/358.15}$$

R₂₅=Resistance at 25.0±0.1 °C

R₅₀=Resistance at 50.0±0.1 °C

R₈₅=Resistance at 85.0±0.1 °C

Specification and Test Method

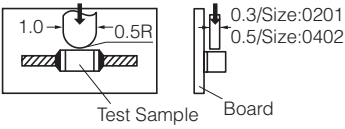
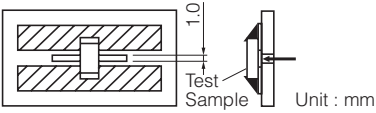
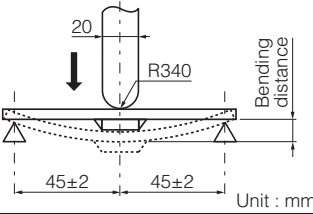
Item	Specification	Test Method									
Rated Zero-power Resistance (R ₂₅)	Within the specified tolerance.	The value is measured at a power that the influence of self-heat generation can be negligible (0.1mW or less), at the rated ambient temperature of 25.0±0.1°C.									
B Value	Shown in each Individual Specification. * Individual Specification shall specify B _{25/50} or B _{25/85} .	<p>The Zero-power resistances; R₁ and R₂, shall be measured respectively at T₁ (deg.C) and T₂ (deg.C). The B value is calculated by the following equation.</p> $B_{T_1/T_2} = \frac{\ln(R_1) - \ln(R_2)}{1/(T_1 + 273.15) - 1/(T_2 + 273.15)}$ <table border="1"> <thead> <tr> <th></th> <th>T₁</th> <th>T₂</th> </tr> </thead> <tbody> <tr> <td>B_{25/50}</td> <td>25.0 ±0.1 °C</td> <td>50.0 ±0.1 °C</td> </tr> <tr> <td>B_{25/85}</td> <td>25.0 ±0.1 °C</td> <td>85.0 ±0.1 °C</td> </tr> </tbody> </table>		T ₁	T ₂	B _{25/50}	25.0 ±0.1 °C	50.0 ±0.1 °C	B _{25/85}	25.0 ±0.1 °C	85.0 ±0.1 °C
	T ₁	T ₂									
B _{25/50}	25.0 ±0.1 °C	50.0 ±0.1 °C									
B _{25/85}	25.0 ±0.1 °C	85.0 ±0.1 °C									
Adhesion	The terminal electrode shall be free from peeling or signs of peeling.	<p>Applied force : Size 0201 : 2 N Size 0402, 0603 : 5 N Duration : 10 s</p> <p>Size : 0201, 0402</p>  <p>Size : 0603</p>  <p>Unit : mm</p>									
Bending Strength	There shall be no cracks and other mechanical damage. R ₂₅ change : within ±5 %	<p>Bending distance : 1 mm Bending speed : 1 mm/s</p>  <p>Unit : mm</p>									
Resistance to Soldering Heat	There shall be no cracks and other mechanical damage. Narrow Tol. type Standard type R ₂₅ change : within ±2 % within ±3 % B Value change : within ±1 % within ±2 %	<p>Soldering bath method Solder temperature : 270 ±5 °C Dipping period : 4.0 ±1 s Preheat condition :</p> <table border="1"> <thead> <tr> <th>Step</th> <th>Temp (°C)</th> <th>Period (s)</th> </tr> </thead> <tbody> <tr> <td>1</td> <td>80 to 100</td> <td>120 to 180</td> </tr> <tr> <td>2</td> <td>150 to 200</td> <td>120 to 180</td> </tr> </tbody> </table>	Step	Temp (°C)	Period (s)	1	80 to 100	120 to 180	2	150 to 200	120 to 180
Step	Temp (°C)	Period (s)									
1	80 to 100	120 to 180									
2	150 to 200	120 to 180									
Solderability	More than 95 % of the soldered area of both terminal electrodes shall be covered with fresh solder.	<p>Soldering bath method Solder temperature : 230 ±5 °C Dipping period : 4 ±1 s Solder : Sn-3.0Ag-0.5Cu</p>									

Specification and Test Method

Item	Specification		Test Method
Temperature Cycling	Narrow Tol. type R ₂₅ change : within ±2 % B Value change : within ±1 %	Standard type within ±3 % within ±2 %	Conditions of one cycle Step 1 : -40 °C, 30±3 min Step 2 : Room temp., 3 min max. Step 3 : 125 °C, 30±3 min. Step 4 : Room temp., 3 min max. Number of cycles: 100 cycles
Humidity	Narrow Tol. type R ₂₅ change : within ±2 % B Value change : within ±1 %	Standard type within ±3 % within ±2 %	Temperature : 85 ±2 °C Relative humidity : 85 ±5 % Test period : 1000 +48/0 h
Biased Humidity	Narrow Tol. type R ₂₅ change : within ±2 % B Value change : within ±1 %	Standard type within ±3 % within ±2 %	Temperature : 85 ±2 °C Relative humidity : 85 ±5 % Applied power : 10 mW(D.C.) Test period : 500 +48/0 h
Low Temperature Exposure	Narrow Tol. type R ₂₅ change : within ±2 % B Value change : within ±1 %	Standard type within ±3 % within ±2 %	Specimens are soldered on the testing board shown in Fig.2. Temperature : -40 ±3 °C Test period : 1000 +48/0 h
High Temperature Exposure	Narrow Tol. type R ₂₅ change : within ±2 % B Value change : within ±1 %	Standard type within ±3 % within ±2 %	Specimens are soldered on the testing board shown in Fig.2. Temperature : 125 ±3 °C Test period : 1000 +48/0 h

Typical Application

● Temperature Detection

Writing current control of HDD

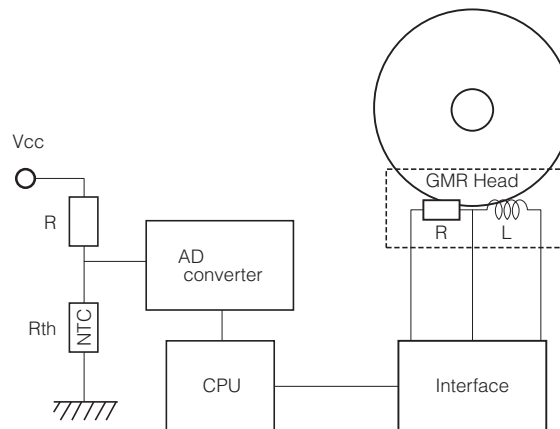

● Temperature Compensation (Pseudo-linearization)

Contrast level control of LCD

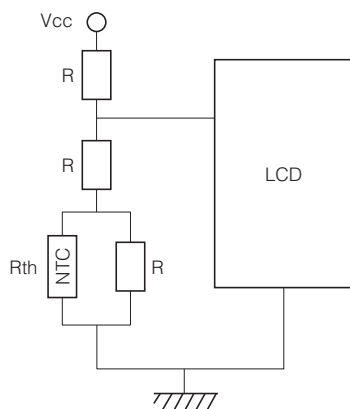

● Temperature Compensation (RF circuit)

Temperature compensation of TCXO

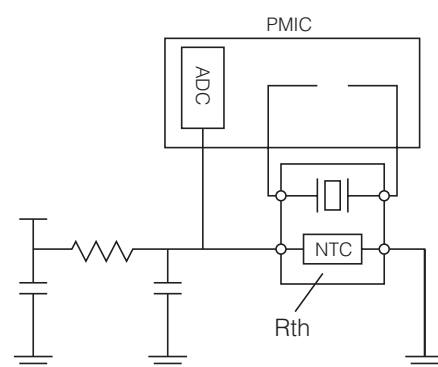

Dimensions in mm (not to scale)

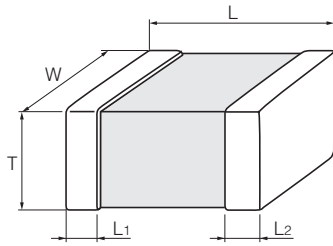

(Unit : mm)

Size Code (EIA)	L	W	T	L ₁ , L ₂
Z(0201)	0.60±0.03	0.30±0.03	0.30±0.03	0.15±0.05
0(0402)	1.0±0.1	0.50±0.05	0.50±0.05	0.25±0.15
1(0603)	1.60±0.15	0.8±0.1	0.8±0.1	0.3±0.2

Packaging Methods

● Standard Packing Quantities

Size Code	Thickness (mm)	Kind of Taping	Pitch (mm)	Quantity (pcs./reel)
Z(0201)	0.3	Pressed Carrier Taping	2	15,000
0(0402)	0.5	Punched Carrier Taping	2	10,000
1(0603)	0.8		4	4,000

● Pitch 2 mm (Pressed Carrier Taping) : Size 0201

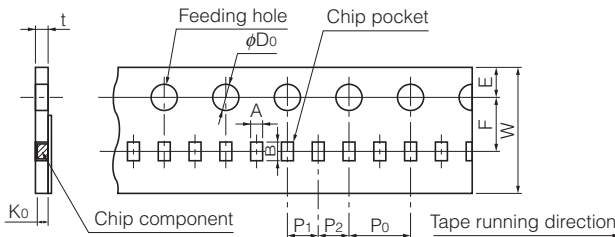

Symbol	A	B	W	F	E	P ₁	P ₂	P ₀	φD ₀	t	K ₀
Dim. (mm)	0.36 ±0.03	0.66 ±0.03	8.0 ±0.2	3.50 ±0.05	1.75 ±0.10	2.00 ±0.05	2.00 ±0.05	4.0 ±0.1	1.5 ^{+0.1} ₀	0.55 max.	0.36 ±0.03

● Pitch 2 mm (Punched Carrier Taping) : Size 0402

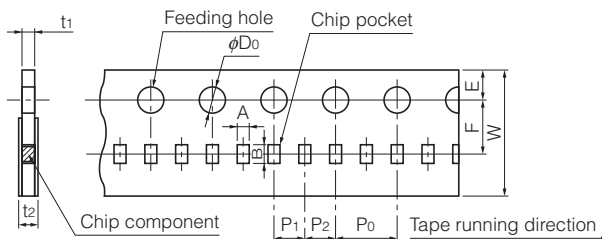

Symbol	A	B	W	F	E	P ₁	P ₂	P ₀	φD ₀	t ₁	t ₂
Dim. (mm)	0.62 ±0.05	1.12 ±0.05	8.0 ±0.2	3.50 ±0.05	1.75 ±0.10	2.00 ±0.05	2.00 ±0.05	4.0 ±0.1	1.5 ^{+0.1} ₀	0.7 max.	1.0 max.

● Pitch 4 mm (Punched Carrier Taping) : Size 0603

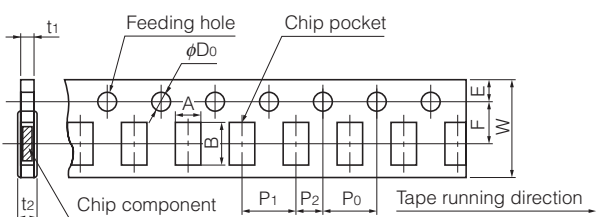

Symbol	A	B	W	F	E	P ₁	P ₂	P ₀	φD ₀	t ₁	t ₂
Dim. (mm)	1.0 ±0.1	1.8 ±0.1	8.0 ±0.2	3.50 ±0.05	1.75 ±0.10	4.0 ±0.1	2.00 ±0.05	4.0 ±0.1	1.5 ^{+0.1} ₀	1.1 max.	1.4 max.

● Reel for Taping

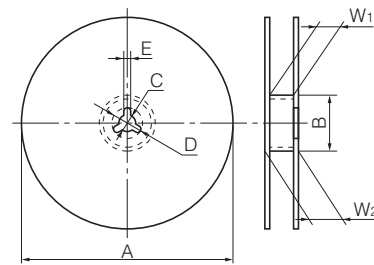

Symbol	φA	φB	C	D	E	W ₁	W ₂
Dim. (mm)	180 ^{-0.3}	60.0 ^{+1.0} ₀	13.0±0.5	21.0±0.8	2.0±0.5	9.0 ^{+1.0} ₀	11.4±1.0

● Leader Part and Taped End

Leader part

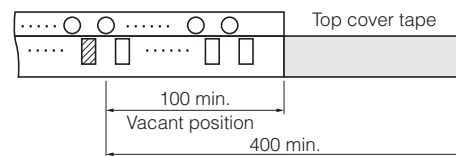

Taped end

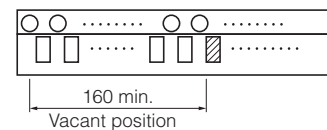

(Unit : mm)

Minimum Quantity / Packing Unit

Part Number (Size)	Minimum Quantity / Packing Unit	Packing Quantity in Carton	Carton L×W×H (mm)
ERTJZ (0201)	15,000	300,000	250×200×200
ERTJ0 (0402)	10,000	200,000	250×200×200
ERTJ1 (0603)	4,000	80,000	250×200×200

Part No., quantity and country of origin are designated on outer packages in English.

Multilayer NTC Thermistors

Series: **ERTJ**

Handling Precautions

⚠ Safety Precautions

Multilayer NTC Thermistors (hereafter referred to as “Thermistors”) should be used for general purpose applications found in consumer electronics (audio/visual, home, office, information & communication) equipment.

When subjected to severe electrical, environmental, and/or mechanical stress beyond the specifications, as noted in the Ratings and Specified Conditions section, the Thermistors’ performance may be degraded, or become failure mode, such as short circuit mode and open-circuit mode. If you use under the condition of short-circuit, heat generation of thermistors will occur by running large current due to application of voltage. There are possibilities of smoke emission, substrate burn-out, and, in the worst case, fire.

For products which require higher safety levels, please carefully consider how a single malfunction can affect your product. In order to ensure the safety in the case of a single malfunction, please design products with fail-safe, such as setting up protecting circuits, etc.

- For the following applications and conditions, please contact us for product of special specification not found in this document.
 - When your application may have difficulty complying with the safety or handling precautions specified below.
 - High-quality and high-reliability required devices that have possibility of causing hazardous conditions, such as death or injury (regardless of directly or indirectly), due to failure or malfunction of the product.
 - ① Aircraft and Aerospace Equipment (artificial satellite, rocket, etc.)
 - ② Submarine Equipment (submarine repeating equipment, etc.)
 - ③ Transportation Equipment (motor vehicles, airplanes, trains, ship, traffic signal controllers, etc.)
 - ④ Power Generation Control Equipment (atomic power, hydroelectric power, thermal power plant control system, etc.)
 - ⑤ Medical Equipment (life-support equipment, pacemakers, dialysis controllers, etc.)
 - ⑥ Information Processing Equipment (large scale computer systems, etc.)
 - ⑦ Electric Heating Appliances, Combustion devices (gas fan heaters, oil fan heaters, etc.)
 - ⑧ Rotary Motion Equipment
 - ⑨ Security Systems
 - ⑩ And any similar types of equipment

Operating Conditions and Circuit Design

1. Circuit Design

1.1 Operating Temperature and Storage Temperature

When operating a components-mounted circuit, please be sure to observe the “Operating Temperature Range”, written in delivery specifications. Please remember not to use the product under the condition that exceeds the specified maximum temperature.

Storage temperature of PCB after mounting Thermistors, which is not operated, should be within the specified “Storage Temperature Range” in the delivery specifications.

1.2 Operating Power

The electricity applied to between terminals of Thermistors should be under the specified maximum power dissipation.

There are possibilities of breakage and burn-out due to excessive self-heating of Thermistors, if the power exceeds maximum power dissipation when operating. Please consider installing protection circuit for your circuit to improve the safety, in case of abnormal voltage application and so on.

Thermistors’ performance of temperature detection would be deteriorated if self-heating occurs, even when you use it under the maximum power dissipation.

Please consider the maximum power dissipation and dissipation factor.

[Maximum power dissipation]

· The Maximum power that can be continuously applied under static air at a certain ambient temperature. The Maximum power dissipation under an ambient temperature of 25 °C or less is the same with the rated maximum power dissipation, and Maximum power dissipation beyond 25 °C depends on the Decreased power dissipation curve below.

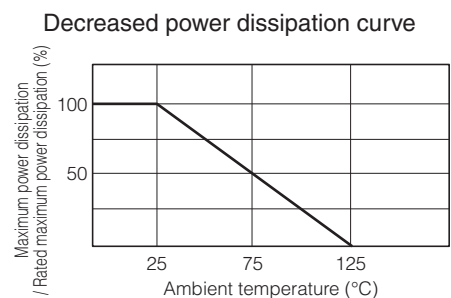

[Dissipation factor]

· The constant amount power required to raise the temperature of the Thermistor 1 °C through self heat generation under stable temperatures.
 Dissipation factor (mW/°C) = Power consumption of Thermistor / Temperature rise of element

1.3 Environmental Restrictions

The Thermistors shall not be operated and/or stored under the following conditions.

- (1) Environmental conditions
 - (a) Under direct exposure to water or salt water
 - (b) Under conditions where water can condense and/or dew can form
 - (c) Under conditions containing corrosive gases such as hydrogen sulfide, sulfurous acid, chlorine and ammonia
- (2) Mechanical conditions

The place where vibration or impact that exceeds specified conditions written in delivery specification is loaded.

1.4 Measurement of Resistance

The resistance of the Thermistors varies depending on ambient temperatures and self-heating. To measure the resistance value when examining circuit configuration and conducting receiving inspection and so on, the following points should be taken into consideration:

- ① Measurement temp : 25 ± 0.1 °C
Measurement in liquid (silicon oil, etc.) is recommended for a stable measurement temperature.
- ② Power : 0.10 mW max.
4 terminal measurement with a constant-current power supply is recommended.

2. Design of Printed Circuit Board

2.1 Selection of Printed Circuit Boards

There is a possibility of performance deterioration by heat shock (temperature cycles), which causes cracks, from alumina substrate.

Please confirm that the substrate you use does not deteriorate the Thermistors' quality.

2.2 Design of Land Pattern

- (1) Recommended land dimensions are shown below. Use the proper amount of solder in order to prevent cracking. Using too much solder places excessive stress on the Thermistors.

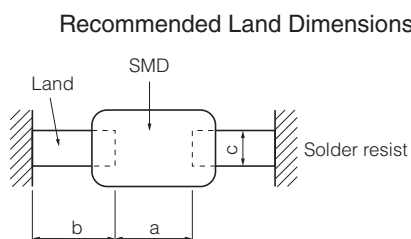

Unit (mm)

Size Code (EIA)	Component dimensions			a	b	c
	L	W	T			
Z(0201)	0.6	0.3	0.3	0.2 to 0.3	0.25 to 0.30	0.2 to 0.3
Q(0402)	1.0	0.5	0.5	0.4 to 0.5	0.4 to 0.5	0.4 to 0.5
1(0603)	1.6	0.8	0.8	0.8 to 1.0	0.6 to 0.8	0.6 to 0.8

- (2) The land size shall be designed to have equal space, on both right and left sides. If the amount of solder on both sides is not equal, the component may be cracked by stress, since the side with a larger amount of solder solidifies later during cooling.

Recommended Amount of Solder

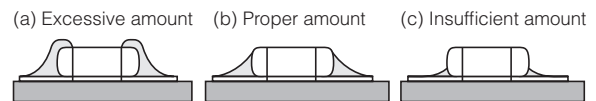

2.3 Utilization of Solder Resist

- (1) Solder resist shall be utilized to equalize the amounts of solder on both sides.
- (2) Solder resist shall be used to divide the pattern for the following cases;
 - Components are arranged closely.
 - The Thermistor is mounted near a component with lead wires.
 - The Thermistor is placed near a chassis.
 Refer to the table below.

Prohibited Applications and Recommended Applications

Item	Prohibited applications	Improved applications by pattern division
Mixed mounting with a component with lead wires	The lead wire of a component with lead wires	Solder resist
Arrangement near chassis	Chassis Solder (Ground solder) Electrode pattern	Solder resist
Retro-fitting of component with lead wires	Soldering iron A lead wire of Retro-fitted component	Solder resist
Lateral arrangement	Portion to be excessively soldered Land	Solder resist

2.4 Component Layout

To prevent the crack of Thermistors, try to place it on the position that could not easily be affected by the bending stress of substrate while mounting procedures or procedures afterwards.

Placement of the Thermistors near heating elements also requires the great care to be taken in order to avoid stresses from rapid heating and cooling.

- (1) To minimize mechanical stress caused by the warp or bending of a PC board, please follow the recommended Thermistors' layout below.

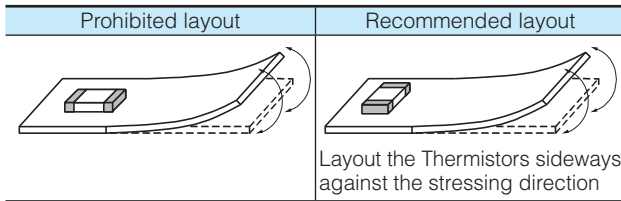

- (2) The following layout is for your reference since mechanical stress near the dividing/breaking position of a PC board varies depending on the mounting position of the Thermistors.

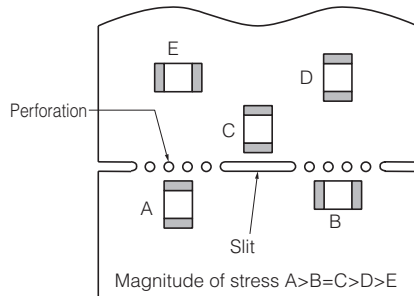

- (3) The magnitude of mechanical stress applied to the Thermistors when dividing the circuit board in descending order is as follows:
push back < slit < V-groove < perforation.
Also take into account the layout of the Thermistors and the dividing/breaking method.
- (4) When the Thermistors are placed near heating elements such as heater, etc., cracks from thermal stresses may occur under following situation:
- Soldering the Thermistors directly to heating elements.
 - Sharing the land with heating elements.
- If planning to conduct above-mentioned mounting and/or placement, please contact us in advance.

2.5 Mounting Density and Spaces

Intervals between components should not be too narrow to prevent the influence from solder bridges and solder balls. The space between components should be carefully determined.

Precautions for Assembly

1. Storage

- (1) The Thermistors shall be stored between 5 to 40 °C and 20 to 70 % RH, not under severe conditions of high temperature and humidity.
- (2) If stored in a place where humidity, dust, or corrosive gasses (hydrogen sulfide, sulfurous acid, hydrogen chloride and ammonia, etc.) are contained, the solderability of terminal electrodes will be deteriorated.
In addition, storage in a places where the heat or direct sunlight exposure occur will cause mounting problems due to deformation of tapes and reels and components and taping/reels sticking together.
- (3) Do not store components longer than 6 months. Check the solderability of products that have been stored for more than 6 months before use

2. Chip Mounting Consideration

- (1) When mounting the Thermistors/components on a PC board, the Thermistor bodies shall be free from excessive impact loads such as mechanical impact or stress due to the positioning, pushing force and displacement of vacuum nozzles during mounting.
- (2) Maintenance and inspection of the Chip Mounter must be performed regularly.
- (3) If the bottom dead center of the vacuum nozzle is too low, the Thermistor will crack from excessive force during mounting.

The following precautions and recommendations are for your reference in use.

- (a) Set and adjust the bottom dead center of the vacuum nozzles to the upper surface of the PC board after correcting the warp of the PC board.
- (b) Set the pushing force of the vacuum nozzle during mounting to 1 to 3 N in static load.
- (c) For double surface mounting, apply a supporting pin on the rear surface of the PC board to suppress the bending of the PC board in order to minimize the impact of the vacuum nozzles. Typical examples are shown in the table below.

Item	Prohibited mounting	Recommended mounting
Single surface mounting	 Crack	 Supporting pin <small>The supporting pin does not necessarily have to be positioned beneath the Thermistor.</small>
Double surface mounting	 Separation of Solder Crack	 Supporting pin

- (d) Adjust the vacuum nozzles so that their bottom dead center during mounting is not too low.
- (4) The closing dimensions of the positioning chucks shall be controlled. Maintenance and replacement of positioning chucks shall be performed regularly to prevent chipping or cracking of the Thermistors caused by mechanical impact during positioning due to worn positioning chucks.
 - (5) Maximum stroke of the nozzle shall be adjusted so that the maximum bending of PC board does not exceed 0.5 mm at 90 mm span. The PC board shall be supported by an adequate number of supporting pins.

3. Selection of Soldering Flux

Soldering flux may seriously affect the performance of the Thermistors. The following shall be confirmed before use.

- (1) The soldering flux should have a halogen based content of 0.1 wt% (converted to chlorine) or below. Do not use soldering flux with strong acid.
- (2) When applying water-soluble soldering flux, wash the Thermistors sufficiently because the soldering flux residue on the surface of PC boards may deteriorate the insulation resistance on the Thermistors' surface.

4. Soldering

4.1 Reflow Soldering

The reflow soldering temperature conditions are composed of temperature curves of Preheating, Temp. rise, Heating, Peak and Gradual cooling. Large temperature difference inside the Thermistors caused by rapid heat application to the Thermistors may lead to excessive thermal stresses, contributing to the thermal cracks. The Preheating temperature requires controlling with great care so that tombstone phenomenon may be prevented.

Item	Temperature	Period or Speed
①Preheating	140 to 180 °C	60 to 120 sec
②Temp. rise	Preheating temp to Peak temp.	2 to 5 °C /sec
③Heating	220 °C min.	60 sec max.
④Peak	260 °C max.	10 sec max.
⑤Gradual cooling	Peak temp. to 140 °C	1 to 4 °C /sec

Recommended profile of Reflow soldering (EX)

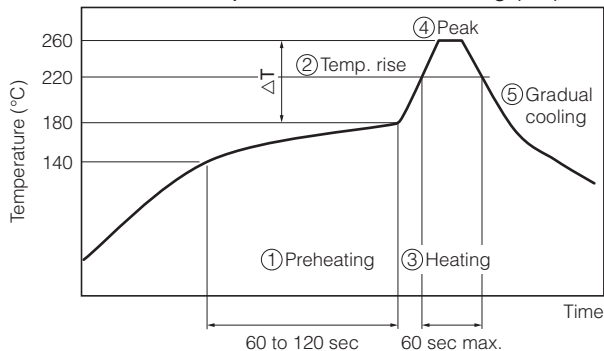

ΔT : Allowable temperature difference $\Delta T \leq 150 \text{ }^\circ\text{C}$

The rapid cooling (forced cooling) during Gradual cooling part should be avoided, because this may cause defects such as the thermal cracks, etc. When the Thermistors are immersed into a cleaning solvent, make sure that the surface temperatures of the devices do not exceed 100 °C. Performing reflow soldering twice under the conditions shown in the figure above [Recommended profile of Reflow soldering (EX)] will not cause any problems. However, pay attention to the possible warp and bending of the PC board.

4.2 Hand Soldering

Hand soldering typically causes significant temperature change, which may induce excessive thermal stresses inside the Thermistors, resulting in the thermal cracks, etc. In order to prevent any defects, the following should be observed.

- The temperature of the soldering tips should be controlled with special care.
- The direct contact of soldering tips with the Thermistors and/or terminal electrodes should be avoided.
- Dismounted Thermistors shall not be reused.

(1) Condition 1 (with preheating)

(a) Soldering:

Use thread solder ($\phi 1$ mm or below) which contains flux with low chlorine, developed for precision electronic equipment.

(b) Preheating:

Conduct sufficient pre-heating, and make sure that the temperature difference between solder and Thermistors' surface is 150 °C or less.

(c) Temperature of Iron tip: 300 °C max.

(The required amount of solder shall be melted in advance on the soldering tip.)

(d) Gradual cooling:

After soldering, the Thermistors shall be cooled gradually at room temperature.

Recommended profile of Hand soldering (EX)

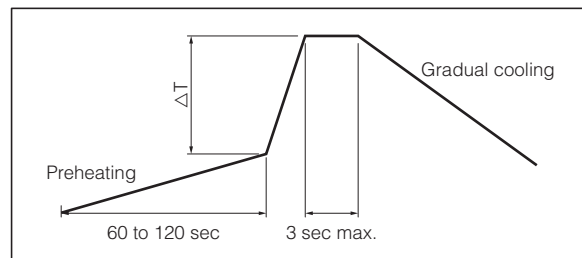

ΔT : Allowable temperature difference $\Delta T \leq 150 \text{ }^\circ\text{C}$

(2) Condition 2 (without preheating)

Hand soldering can be performed without preheating, by following the conditions below:

- (a) Soldering iron tip shall never directly touch the ceramic and terminal electrodes of the Thermistors.
- (b) The lands are sufficiently preheated with a soldering iron tip before sliding the soldering iron tip to the terminal electrodes of the Thermistors for soldering.

Conditions of Hand soldering without preheating

Item	Condition
Temperature of Iron tip	270 °C max.
Wattage	20 W max.
Shape of Iron tip	$\phi 3$ mm max.
Soldering time with a soldering iron	3 sec max.

5. Post Soldering Cleaning

5.1 Cleaning solvent

Soldering flux residue may remain on the PC board if cleaned with an inappropriate solvent. This may deteriorate the electrical characteristics and reliability of the Thermistors.

5.2 Cleaning conditions

Inappropriate cleaning conditions such as insufficient cleaning or excessive cleaning may impair the electrical characteristics and reliability of the Thermistors.

(1) Insufficient cleaning can lead to:

- (a) The halogen substance found in the residue of the soldering flux may cause the metal of terminal electrodes to corrode.
- (b) The halogen substance found in the residue of the soldering flux on the surface of the Thermistors may change resistance values.
- (c) Water-soluble soldering flux may have more remarkable tendencies of (a) and (b) above compared to those of rosin soldering flux.

- (2) Excessive cleaning can lead to:
- When using ultrasonic cleaner, make sure that the output is not too large, so that the substrate will not resonate. The resonance causes the cracks in Varistors and/or solders, and deteriorates the strength of the terminal electrodes. Please follow these conditions for Ultrasonic cleaning:
 Ultrasonic wave output : 20 W/L max.
 Ultrasonic wave frequency : 40 kHz max.
 Ultrasonic wave cleaning time : 5 min. max.

5.3 Contamination of Cleaning solvent

Cleaning with contaminated cleaning solvent may cause the same results as insufficient cleaning due to the high density of liberated halogen.

6. Inspection Process

The pressure from measuring terminal pins might bend the PCB when implementing circuit inspection after mounting Thermistors on PCB, and as a result, cracking may occur.

- Mounted PC boards shall be supported by an adequate number of supporting pins on the back with bend settings of 90 mm span 0.5 mm max.
- Confirm that the measuring pins have the right tip shape, are equal in height, have the right pressure, and are set in the correct positions. The following figures are for your reference to avoid bending the PC board.

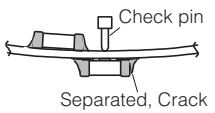
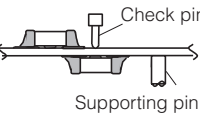
Item	Prohibited setting	Recommended setting
Bending of PC board	 Separated, Crack	 Supporting pin

7. Protective Coating

When the surface of a PC board on which the Thermistors have been mounted is coated with resin to protect against moisture and dust, it shall be confirmed that the protective coating does not affect the performance of Varistors.

- Choose the material that does not emit the decomposition and/or reaction gas. The Gas may affect the composing members of the Varistors.
- Shrinkage and expansion of resin coating when curing may apply stress to the Varistors and may lead to occurrence of cracks.

8. Dividing/Breaking of PC Boards

- Please be careful not to stress the substrate with bending/twisting when dividing, after mounting components including Varistors. Abnormal and excessive mechanical stress such as bending or torsion shown below can cause cracking in the Thermistors.



- Dividing/Breaking of the PC boards shall be done carefully at moderate speed by using a jig or apparatus to protect the Thermistors on the boards from mechanical damage.

- Examples of PCB dividing/breaking jigs:

The outline of PC board breaking jig is shown below. When PC boards are broken or divided, loading points should be close to the jig to minimize the extent of the bending

Also, planes with no parts mounted on should be used as plane of loading, in order to prevent tensile stress induced by the bending, which may cause cracks of the Thermistors or other parts mounted on the PC boards.

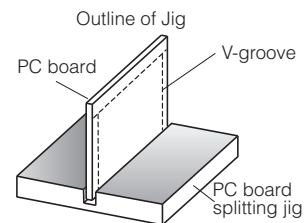

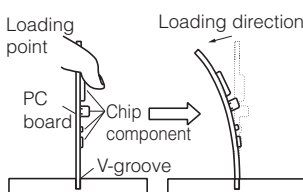
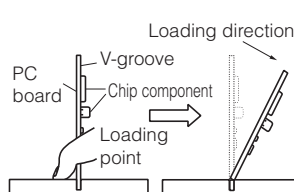
Prohibited dividing	Recommended dividing
	

9. Mechanical Impact

- The Thermistors shall be free from any excessive mechanical impact. The Thermistor body is made of ceramics and may be damaged or cracked if dropped. Never use a Thermistor which has been dropped; their quality may be impaired and failure rate increased.
- When handling PC boards with Thermistors mounted on them, do not allow the Thermistors to collide with another PC board. When mounted PC boards are handled or stored in a stacked state, the corner of a PC board might strike Thermistors, and the impact of the strike may cause damage or cracking and can deteriorate the withstand voltage and insulation resistance of the Thermistor.

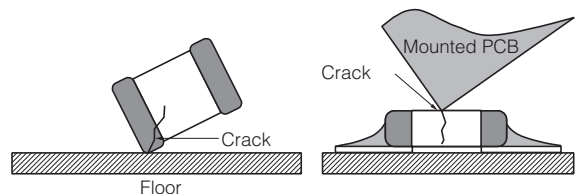

Other

The various precautions described above are typical. For special mounting conditions, please contact us.

Multilayer NTC Thermistors (Automotive Grade)

Series: **ERTJ-M**

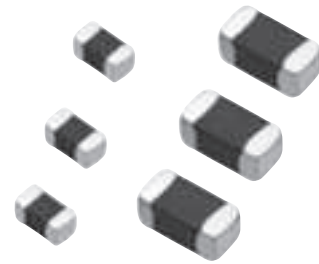

Features

- Surface Mount Device (0402, 0603)
- Highly reliable multilayer / monolithic structure
- Wide temperature operating range (–40 to 150 °C)
- Environmentally-friendly lead-free
- AEC-Q200 qualified
- RoHS compliant

Recommended Applications

- For car audio system
- For ECUs
- For electric pumps and compressors
- For LED lights
- For batteries
- For temperature detection of various circuits

Explanation of Part Numbers

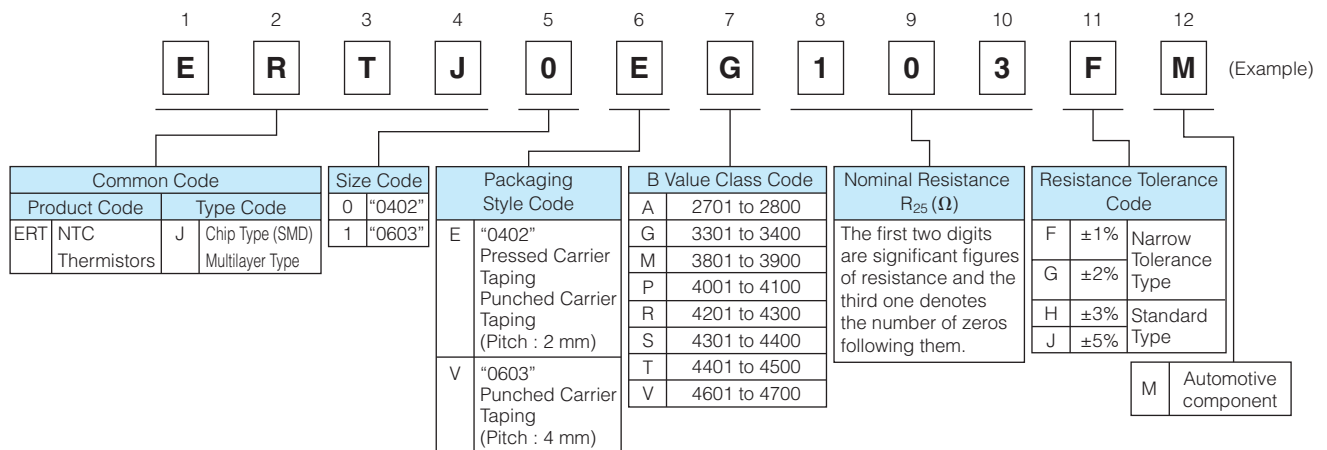

Construction

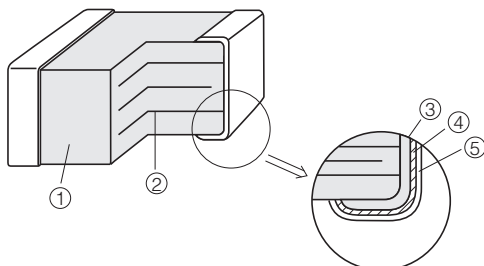

No.	Name	
①	Semiconductive Ceramics	
②	Internal electrode	
③	Terminal electrode	Substrate electrode
④		Intermediate electrode
⑤		External electrode

Ratings

Size code (EIA)	0(0402)	1(0603)
Operating Temperature Range	-40 to 150 °C	
Rated Maximum Power Dissipation*1	66 mW	100 mW
Dissipation Factor*2	Approximately 2 mW/°C	Approximately 3 mW/°C

- *1 Rated Maximum Power Dissipation : The maximum power that can be continuously applied at the rated ambient temperature.
 · The maximum value of power, and rated power is same under the condition of ambient temperature 25 °C or less. If the temperature exceeds 25 °C, rated power depends on the decreased power dissipation curve.
 · Please see "Operating Power" for details.
- *2 Dissipation factor : The constant amount power required to raise the temperature of the Thermistor 1 °C through self heat generation under stable temperatures.
 · Dissipation factor is the reference value when mounted on a glass epoxy board (1.6 mmT).

Part Number List

● 0402(EIA)

Part Number	Nominal Resistance at 25 °C	B Value at 25/50(K)	B Value at 25/85(K)
ERTJ0EG202GM	2 kΩ±2 %	(3380 K)	3410 K±0.5 %
ERTJ0EG202HM	2 kΩ±3 %	(3380 K)	3410 K±0.5 %
ERTJ0EG202JM	2 kΩ±5 %	(3380 K)	3410 K±0.5 %
ERTJ0EG103□M	10 kΩ	3380 K±1 %	3435 K±1 %
ERTJ0EP473□M	47 kΩ	4050 K±1 %	(4100 K)
ERTJ0ER104□M	100 kΩ	4250 K±1 %	(4300 K)
ERTJ0ET104□M	100 kΩ	4485 K±1 %	(4550 K)
ERTJ0EV104□M	100 kΩ	4700 K±1 %	(4750 K)
ERTJ0EV474□M	470 kΩ	4700 K±1 %	(4750 K)

□ : Resistance Tolerance Code (F : ±1%, G : ±2%, H : ±3%, J : ±5%)

● 0603(EIA)

Part Number	Nominal Resistance at 25 °C	B Value at 25/50(K)	B Value at 25/85(K)
ERTJ1VK102□M	1 kΩ	3650 K±1 %	(3690 K)
ERTJ1VG103□M	10 kΩ	3380 K±1 %	3435 K±1 %
ERTJ1VP473□M	47 kΩ	4100 K±1 %	(4150 K)
ERTJ1VR104□M	100 kΩ	4200 K±1 %	(4250 K)
ERTJ1VV104□M	100 kΩ	4700 K±1 %	(4750 K)
ERTJ1VT224□M	220 kΩ	4485 K±1 %	(4550 K)

□ : Resistance Tolerance Code (F : ±1%, G : ±2%, H : ±3%, J : ±5%)

● Temperature and Resistance value (the resistance value at 25 °C is set to 1)/ Reference values

	ERTJ□□G to	ERTJ1VK to	ERTJ0EP to	ERTJ1VP to	ERTJ0ER to	ERTJ1VR to	ERTJ□□T to	ERTJ□□V to
B _{25/50}	(3380 K)	3650 K	4050 K	4100 K	4250 K	4200 K	4485 K	4700 K
B _{25/85}	3435 K	(3690 K)	(4100 K)	(4150 K)	(4300 K)	(4250 K)	(4550 K)	(4750 K)
T(°C)								
-40	20.52	25.77	33.10	34.56	42.40	40.49	46.47	59.76
-35	15.48	19.10	24.03	24.99	29.96	28.81	32.92	41.10
-30	11.79	14.29	17.63	18.26	21.42	20.72	23.55	28.61
-25	9.069	10.79	13.06	13.48	15.50	15.07	17.00	20.14
-20	7.037	8.221	9.761	10.04	11.33	11.06	12.38	14.33
-15	5.507	6.312	7.362	7.546	8.370	8.198	9.091	10.31
-10	4.344	4.883	5.599	5.720	6.244	6.129	6.729	7.482
-5	3.453	3.808	4.291	4.369	4.699	4.622	5.019	5.481
0	2.764	2.993	3.312	3.362	3.565	3.515	3.772	4.050
5	2.227	2.372	2.574	2.604	2.725	2.694	2.854	3.015
10	1.806	1.892	2.013	2.030	2.098	2.080	2.173	2.262
15	1.474	1.520	1.584	1.593	1.627	1.618	1.666	1.710
20	1.211	1.229	1.255	1.258	1.271	1.267	1.286	1.303
25	1	1	1	1	1	1	1	1
30	0.8309	0.8185	0.8016	0.7994	0.7923	0.7944	0.7829	0.7734
35	0.6941	0.6738	0.6461	0.6426	0.6318	0.6350	0.6168	0.6023
40	0.5828	0.5576	0.5235	0.5194	0.5069	0.5108	0.4888	0.4721
45	0.4916	0.4639	0.4266	0.4222	0.4090	0.4132	0.3896	0.3723
50	0.4165	0.3879	0.3496	0.3451	0.3320	0.3363	0.3123	0.2954
55	0.3543	0.3258	0.2881	0.2837	0.2709	0.2752	0.2516	0.2356
60	0.3027	0.2749	0.2386	0.2344	0.2222	0.2263	0.2037	0.1889
65	0.2595	0.2330	0.1985	0.1946	0.1831	0.1871	0.1658	0.1523
70	0.2233	0.1984	0.1659	0.1623	0.1516	0.1554	0.1357	0.1236
75	0.1929	0.1696	0.1393	0.1359	0.1261	0.1297	0.1117	0.1009
80	0.1672	0.1456	0.1174	0.1143	0.1054	0.1087	0.09236	0.08284
85	0.1451	0.1255	0.09937	0.09658	0.08843	0.09153	0.07675	0.06834
90	0.1261	0.1087	0.08442	0.08189	0.07457	0.07738	0.06404	0.05662
95	0.1097	0.09440	0.07200	0.06969	0.06316	0.06567	0.05366	0.04712
100	0.09563	0.08229	0.06166	0.05957	0.05371	0.05596	0.04518	0.03939
105	0.08357	0.07195	0.05306	0.05117	0.04585	0.04786	0.03825	0.03308
110	0.07317	0.06311	0.04587	0.04415	0.03929	0.04108	0.03255	0.02791
115	0.06421	0.05552	0.03979	0.03823	0.03378	0.03539	0.02781	0.02364
120	0.05650	0.04899	0.03460	0.03319	0.02913	0.03059	0.02382	0.02009
125	0.04986	0.04336	0.03013	0.02886	0.02519	0.02652	0.02043	0.01712
130	0.04413	0.03849	0.02629	0.02513	0.02184	0.02307	0.01755	0.01464
135	0.03916	0.03426	0.02298	0.02193	0.01898	0.02013	0.01511	0.01256
140	0.03483	0.03058	0.02013	0.01918	0.01654	0.01762	0.01304	0.01080
145	0.03105	0.02736	0.01767	0.01680	0.01445	0.01546	0.01127	0.00931
150	0.02774	0.02454	0.01553	0.01476	0.01265	0.01361	0.00976	0.00806

$$B_{25/50} = \frac{\ln(R_{25}/R_{50})}{1/298.15 - 1/323.15}$$

$$B_{25/85} = \frac{\ln(R_{25}/R_{85})}{1/298.15 - 1/358.15}$$

R₂₅=Resistance at 25.0±0.1 °C
 R₅₀=Resistance at 50.0±0.1 °C
 R₈₅=Resistance at 85.0±0.1 °C

Specification and Test Method

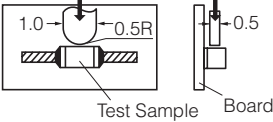
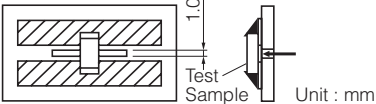
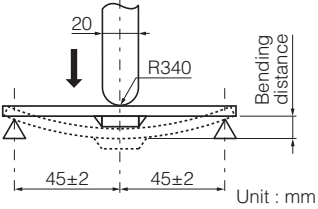
Item	Specification	Test Method									
Rated Zero-power Resistance (R ₂₅)	Within the specified tolerance.	The value is measured at a power that the influence of self-heat generation can be negligible (0.1mW or less), at the rated ambient temperature of 25.0±0.1°C.									
B Value	Shown in each Individual Specification. * Individual Specification shall specify B _{25/50} or B _{25/85} .	<p>The Zero-power resistances; R₁ and R₂, shall be measured respectively at T₁ (deg.C) and T₂ (deg.C). The B value is calculated by the following equation.</p> $B_{T_1/T_2} = \frac{\ln(R_1) - \ln(R_2)}{1/(T_1 + 273.15) - 1/(T_2 + 273.15)}$ <table border="1"> <thead> <tr> <th></th> <th>T₁</th> <th>T₂</th> </tr> </thead> <tbody> <tr> <td>B_{25/50}</td> <td>25.0 ±0.1 °C</td> <td>50.0 ±0.1 °C</td> </tr> <tr> <td>B_{25/85}</td> <td>25.0 ±0.1 °C</td> <td>85.0 ±0.1 °C</td> </tr> </tbody> </table>		T ₁	T ₂	B _{25/50}	25.0 ±0.1 °C	50.0 ±0.1 °C	B _{25/85}	25.0 ±0.1 °C	85.0 ±0.1 °C
	T ₁	T ₂									
B _{25/50}	25.0 ±0.1 °C	50.0 ±0.1 °C									
B _{25/85}	25.0 ±0.1 °C	85.0 ±0.1 °C									
Adhesion	The terminal electrode shall be free from peeling or signs of peeling.	<p>Applied force : Size 0402, 0603 : 5 N Duration : 10 s</p> <p>Size : 0402</p>  <p>Size : 0603</p>  <p>Unit : mm</p>									
Bending Strength	There shall be no cracks and other mechanical damage. R ₂₅ change : within ±5 %	<p>Bending distance : 2 mm Bending speed : 1 mm/s</p>  <p>Unit : mm</p>									
Resistance to Vibration	There shall be no cracks and other mechanical damage. R ₂₅ change : within ±2 % B Value change : within ±1 %	<p>Solder samples on a testing substrate, then apply vibration to them.</p> <p>Acceleration : 5 G Vibrational frequency : 10 to 2000 Hz Sweep time : 20 minutes 12 cycles in three directions, which are perpendicular to each other</p>									
Resistance to Impact	There shall be no cracks and other mechanical damage. R ₂₅ change : within ±2 % B Value change : within ±1 %	<p>Solder samples on a testing substrate, then apply impacts to them.</p> <p>Pulse waveform : Semisinusoidal wave, 11 ms Impact acceleration : 50 G Impact direction : X-X', Y-Y', Z-Z' In 6 directions, three times each</p>									

Specification and Test Method

Item	Specification	Test Method							
Resistance to Soldering Heat	There shall be no cracks and other mechanical damage. R ₂₅ change : within ±2 % B Value change : within ±1 %	Soldering bath method Solder temperature : 260 ±5 °C, 270 ±5 °C Dipping period : 3.0 ±0.5 s, 10.0 ±0.5 s Preheat condition :							
		<table border="1"> <thead> <tr> <th>Step</th> <th>Temp (°C)</th> <th>Period (s)</th> </tr> </thead> <tbody> <tr> <td>1</td> <td>80 to 100</td> <td>120 to 180</td> </tr> <tr> <td>2</td> <td>150 to 200</td> <td>120 to 180</td> </tr> </tbody> </table>	Step	Temp (°C)	Period (s)	1	80 to 100	120 to 180	2
Step	Temp (°C)	Period (s)							
1	80 to 100	120 to 180							
2	150 to 200	120 to 180							
Solderability	More than 95 % of the soldered area of both terminal electrodes shall be covered with fresh solder.	Soldering bath method Solder temperature : 230 ±5 °C Dipping period : 4 ±1 s Solder : Sn-3.0Ag-0.5Cu							
Temperature Cycling	R ₂₅ change : within ±2 % B Value change : within ±1 %	Conditions of one cycle Step 1 : -55±3 °C, 30±3 min. Step 2 : Room temp., 3 min. max. Step 3 : 125±5 °C, 30±3 min. Step 4 : Room temp., 3 min. max. Number of cycles: 2000 cycles							
Humidity	R ₂₅ change : within ±2 % B Value change : within ±1 %	Temperature : 85 ±2 °C Relative humidity : 85 ±5 % Test period : 2000 +48/0 h							
Biased Humidity	R ₂₅ change : within ±2 % B Value change : within ±1 %	Temperature : 85 ±2 °C Relative humidity: 85 ±5 % Applied power : 10 mW(D.C.) Test period : 2000 +48/0 h							
Low Temperature Exposure	R ₂₅ change : within ±2 % B Value change : within ±1 %	Temperature : -40 ±3 °C Test period : 2000 +48/0 h							
High Temperature Exposure 1	R ₂₅ change : within ±2 % B Value change : within ±1 %	Temperature : 125 ±3 °C Test period : 2000 +48/0 h							
High Temperature Exposure 2	R ₂₅ change : within ±3 % B Value change : within ±2 %	Temperature : 150 ±3 °C Test period : 1000 +48/0 h							

Dimensions in mm (not to scale)

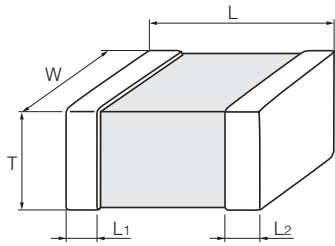

(Unit: mm)

Size Code (EIA)	L	W	T	L ₁ , L ₂
0 (0402)	1.0±0.1	0.50±0.05	0.50±0.05	0.25±0.15
1 (0603)	1.60±0.15	0.8±0.1	0.8±0.1	0.3±0.2

Packaging Methods

● Standard Packing Quantities

Size Code	Thickness (mm)	Kind of Taping	Pitch (mm)	Quantity (pcs./reel)
0 (0402)	0.5	Punched Carrier Taping	2	10,000
1 (0603)	0.8		4	4,000

● Reel for Taping

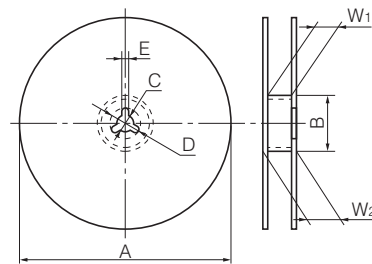

Symbol	φA	φB	C	D	E	W ₁	W ₂
Dim. (mm)	180 ^{-0.3}	60.0 ^{+1.0} ₀	13.0±0.5	21.0±0.8	2.0±0.5	9.0 ^{+1.0} ₀	11.4±1.0

● Pitch 2 mm (Punched Carrier Taping) : Size 0402

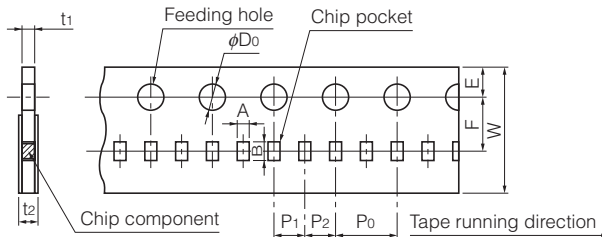

Symbol	A	B	W	F	E	P ₁	P ₂	P ₀	φD ₀	t ₁	t ₂
Dim. (mm)	0.62 ±0.05	1.12 ±0.05	8.0 ±0.2	3.50 ±0.05	1.75 ±0.10	2.00 ±0.05	2.00 ±0.05	4.0 ±0.1	1.5 ^{+0.1} ₀	0.7 max.	1.0 max.

● Pitch 4 mm (Punched Carrier Taping) : Size 0603

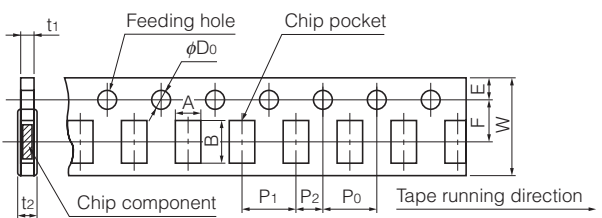

Symbol	A	B	W	F	E	P ₁	P ₂	P ₀	φD ₀	t ₁	t ₂
Dim. (mm)	1.0 ±0.1	1.8 ±0.1	8.0 ±0.2	3.50 ±0.05	1.75 ±0.10	4.0 ±0.1	2.00 ±0.05	4.0 ±0.1	1.5 ^{+0.1} ₀	1.1 max.	1.4 max.

● Leader Part and Taped End

Leader part

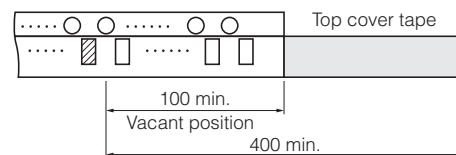

Taped end

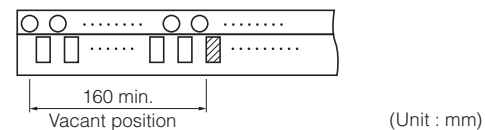

Minimum Quantity / Packing Unit

Part Number (Size)	Minimum Quantity/ Packing Unit	Packing Quantity in Carton	Carton L×W×H (mm)
ERTJ0 (0402)	10,000	200,000	250×200×200
ERTJ1 (0603)	4,000	80,000	250×200×200

Part No., quantity and country of origin are designated on outer packages in English.

Multilayer NTC Thermistors (Automotive Grade)

Series: **ERTJ-M**

Handling Precautions

⚠ Safety Precautions

The Multilayer NTC Thermistors (Automotive Grade), hereafter referred to as Thermistors, is designed for use in automotive devices. When subjected to severe electrical, environmental, and/or mechanical stress beyond the specifications, as noted in the Ratings and Specified Conditions section, the Thermistors' performance may be degraded, or become failure mode, such as short circuit mode and open-circuit mode. If you use under the condition of short-circuit, heat generation of thermistors will occur by running large current due to application of voltage. There are possibilities of smoke emission, substrate burn-out, and, in the worst case, fire.

For products which require higher safety levels, please carefully consider how a single malfunction can affect your product. In order to ensure the safety in the case of a single malfunction, please design products with fail-safe, such as setting up protecting circuits, etc.

- For the following applications and conditions, please contact us for product of special specification not found in this document.
 - When your application may have difficulty complying with the safety or handling precautions specified below.
 - High-quality and high-reliability required devices that have possibility of causing hazardous conditions, such as death or injury (regardless of directly or indirectly), due to failure or malfunction of the product.
 - ① Aircraft and Aerospace Equipment (artificial satellite, rocket, etc.)
 - ② Submarine Equipment (submarine repeating equipment, etc.)
 - ③ Transportation Equipment (airplanes, trains, ship, traffic signal controllers, etc.)
 - ④ Power Generation Control Equipment (atomic power, hydroelectric power, thermal power plant control system, etc.)
 - ⑤ Medical Equipment (life-support equipment, pacemakers, dialysis controllers, etc.)
 - ⑥ Information Processing Equipment (large scale computer systems, etc.)
 - ⑦ Electric Heating Appliances, Combustion devices (gas fan heaters, oil fan heaters, etc.)
 - ⑧ Rotary Motion Equipment
 - ⑨ Security Systems
 - ⑩ And any similar types of equipment

Operating Conditions and Circuit Design

1. Circuit Design

1.1 Operating Temperature and Storage Temperature

When operating a components-mounted circuit, please be sure to observe the "Operating Temperature Range", written in delivery specifications. Please remember not to use the product under the condition that exceeds the specified maximum temperature.

Storage temperature of PCB after mounting Thermistors, which is not operated, should be within the specified "Storage Temperature Range" in the delivery specifications.

1.2 Operating Power

The electricity applied to between terminals of Thermistors should be under the specified maximum power dissipation.

There are possibilities of breakage and burn-out due to excessive self-heating of Thermistors, if the power exceeds maximum power dissipation when operating. Please consider installing protection circuit for your circuit to improve the safety, in case of abnormal voltage application and so on.

Thermistors' performance of temperature detection would be deteriorated if self-heating occurs, even when you use it under the maximum power dissipation.

Please consider the maximum power dissipation and dissipation factor.

[Maximum power dissipation]

· The Maximum power that can be continuously applied under static air at a certain ambient temperature. The Maximum power dissipation under an ambient temperature of 25 °C or less is the same with the rated maximum power dissipation, and Maximum power dissipation beyond 25 °C depends on the Decreased power dissipation curve below.

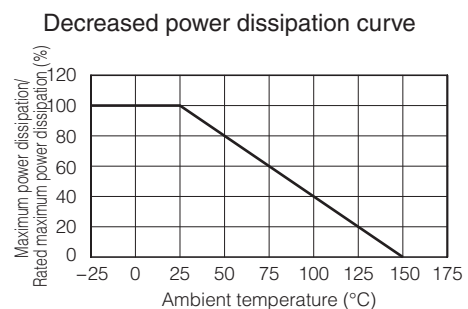

[Dissipation factor]

· The constant amount power required to raise the temperature of the Thermistor 1 °C through self heat generation under stable temperatures.
 Dissipation factor (mW/°C) = Power consumption of Thermistor / Temperature rise of element

1.3 Environmental Restrictions

The Thermistors shall not be operated and/or stored under the following conditions.

- (1) Environmental conditions
 - (a) Under direct exposure to water or salt water
 - (b) Under conditions where water can condense and/or dew can form
 - (c) Under conditions containing corrosive gases such as hydrogen sulfide, sulfurous acid, chlorine and ammonia
- (2) Mechanical conditions

The place where vibration or impact that exceeds specified conditions written in delivery specification is loaded.

1.4 Measurement of Resistance

The resistance of the Thermistors varies depending on ambient temperatures and self-heating. To measure the resistance value when examining circuit configuration and conducting receiving inspection and so on, the following points should be taken into consideration:

- ① Measurement temp : 25 ± 0.1 °C
Measurement in liquid (silicon oil, etc.) is recommended for a stable measurement temperature.
- ② Power : 0.10 mW max.
4 terminal measurement with a constant-current power supply is recommended.

2. Design of Printed Circuit Board

2.1 Selection of Printed Circuit Boards

There is a possibility of performance deterioration by heat shock (temperature cycles), which causes cracks, from alumina substrate.

Please confirm that the substrate you use does not deteriorate the Thermistors' quality.

2.2 Design of Land Pattern

- (1) Recommended land dimensions are shown below. Use the proper amount of solder in order to prevent cracking. Using too much solder places excessive stress on the Thermistors.

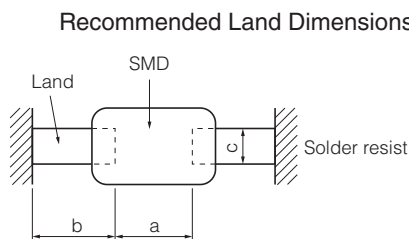

Unit (mm)

Size Code (EIA)	Component dimensions			a	b	c
	L	W	T			
0(0402)	1.0	0.5	0.5	0.4 to 0.5	0.4 to 0.5	0.4 to 0.5
1(0603)	1.6	0.8	0.8	0.8 to 1.0	0.6 to 0.8	0.6 to 0.8

- (2) The land size shall be designed to have equal space, on both right and left sides. If the amount of solder on both sides is not equal, the component may be cracked by stress, since the side with a larger amount of solder solidifies later during cooling.

Recommended Amount of Solder

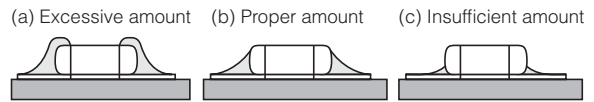

2.3 Utilization of Solder Resist

- (1) Solder resist shall be utilized to equalize the amounts of solder on both sides.
- (2) Solder resist shall be used to divide the pattern for the following cases;
 - Components are arranged closely.
 - The Thermistor is mounted near a component with lead wires.
 - The Thermistor is placed near a chassis.
 Refer to the table below.

Prohibited Applications and Recommended Applications

Item	Prohibited applications	Improved applications by pattern division
Mixed mounting with a component with lead wires	The lead wire of a component with lead wires	Solder resist
Arrangement near chassis	Chassis Solder (Ground solder) Electrode pattern	Solder resist
Retro-fitting of component with lead wires	Soldering iron A lead wire of Retro-fitted component	Solder resist
Lateral arrangement	Portion to be excessively soldered Land	Solder resist

2.4 Component Layout

To prevent the crack of Thermistors, try to place it on the position that could not easily be affected by the bending stress of substrate while mounting procedures or procedures afterwards.

Placement of the Thermistors near heating elements also requires the great care to be taken in order to avoid stresses from rapid heating and cooling.

- (1) To minimize mechanical stress caused by the warp or bending of a PC board, please follow the recommended Thermistors' layout below.

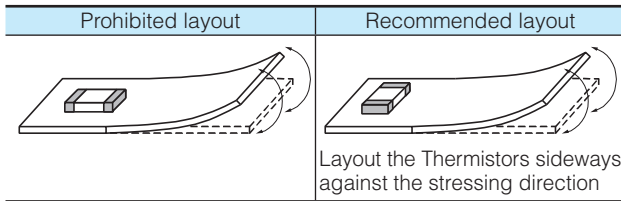

- (2) The following layout is for your reference since mechanical stress near the dividing/breaking position of a PC board varies depending on the mounting position of the Thermistors.

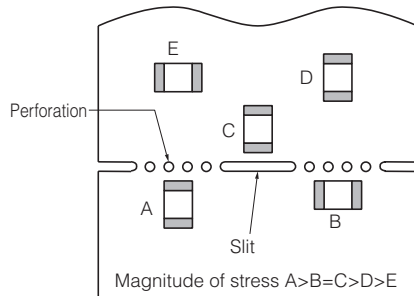

- (3) The magnitude of mechanical stress applied to the Thermistors when dividing the circuit board in descending order is as follows:
push back < slit < V-groove < perforation.
Also take into account the layout of the Thermistors and the dividing/breaking method.
- (4) When the Thermistors are placed near heating elements such as heater, etc., cracks from thermal stresses may occur under following situation:
- Soldering the Thermistors directly to heating elements.
 - Sharing the land with heating elements.
- If planning to conduct above-mentioned mounting and/or placement, please contact us in advance.

2.5 Mounting Density and Spaces

Intervals between components should not be too narrow to prevent the influence from solder bridges and solder balls. The space between components should be carefully determined.

Precautions for Assembly

1. Storage

- (1) The Thermistors shall be stored between 5 to 40 °C and 20 to 70 % RH, not under severe conditions of high temperature and humidity.
- (2) If stored in a place where humidity, dust, or corrosive gasses (hydrogen sulfide, sulfuric acid, hydrogen chloride and ammonia, etc.) are contained, the solderability of terminal electrodes will be deteriorated.
In addition, storage in a places where the heat or direct sunlight exposure occur will cause mounting problems due to deformation of tapes and reels and components and taping/reels sticking together.
- (3) Do not store components longer than 6 months. Check the solderability of products that have been stored for more than 6 months before use

2. Chip Mounting Consideration

- (1) When mounting the Thermistors/components on a PC board, the Thermistor bodies shall be free from excessive impact loads such as mechanical impact or stress due to the positioning, pushing force and displacement of vacuum nozzles during mounting.
- (2) Maintenance and inspection of the Chip Mounter must be performed regularly.
- (3) If the bottom dead center of the vacuum nozzle is too low, the Thermistor will crack from excessive force during mounting.

The following precautions and recommendations are for your reference in use.

- (a) Set and adjust the bottom dead center of the vacuum nozzles to the upper surface of the PC board after correcting the warp of the PC board.
- (b) Set the pushing force of the vacuum nozzle during mounting to 1 to 3 N in static load.
- (c) For double surface mounting, apply a supporting pin on the rear surface of the PC board to suppress the bending of the PC board in order to minimize the impact of the vacuum nozzles. Typical examples are shown in the table below.

Item	Prohibited mounting	Recommended mounting
Single surface mounting		 The supporting pin does not necessarily have to be positioned beneath the Thermistor.
Double surface mounting		

- (d) Adjust the vacuum nozzles so that their bottom dead center during mounting is not too low.
- (4) The closing dimensions of the positioning chucks shall be controlled. Maintenance and replacement of positioning chucks shall be performed regularly to prevent chipping or cracking of the Thermistors caused by mechanical impact during positioning due to worn positioning chucks.
- (5) Maximum stroke of the nozzle shall be adjusted so that the maximum bending of PC board does not exceed 0.5 mm at 90 mm span. The PC board shall be supported by an adequate number of supporting pins.

3. Selection of Soldering Flux

Soldering flux may seriously affect the performance of the Thermistors. The following shall be confirmed before use.

- (1) The soldering flux should have a halogen based content of 0.1 wt% (converted to chlorine) or below. Do not use soldering flux with strong acid.
- (2) When applying water-soluble soldering flux, wash the Thermistors sufficiently because the soldering flux residue on the surface of PC boards may deteriorate the insulation resistance on the Thermistors' surface.

4. Soldering

4.1 Reflow Soldering

The reflow soldering temperature conditions are composed of temperature curves of Preheating, Temp. rise, Heating, Peak and Gradual cooling. Large temperature difference inside the Thermistors caused by rapid heat application to the Thermistors may lead to excessive thermal stresses, contributing to the thermal cracks. The Preheating temperature requires controlling with great care so that tombstone phenomenon may be prevented.

Item	Temperature	Period or Speed
①Preheating	140 to 180 °C	60 to 120 sec
②Temp. rise	Preheating temp to Peak temp.	2 to 5 °C /sec
③Heating	220 °C min.	60 sec max.
④Peak	260 °C max.	10 sec max.
⑤Gradual cooling	Peak temp. to 140 °C	1 to 4 °C /sec

Recommended profile of Reflow soldering (EX)

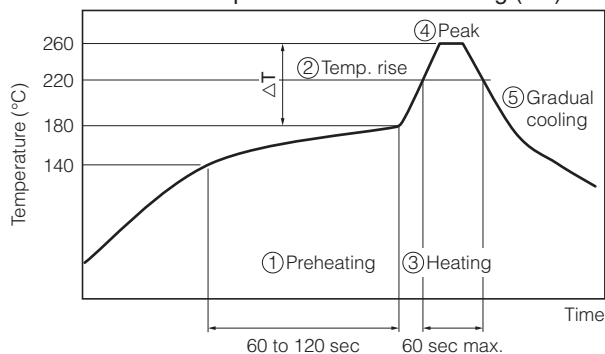

ΔT : Allowable temperature difference $\Delta T \leq 150 \text{ }^\circ\text{C}$

The rapid cooling (forced cooling) during Gradual cooling part should be avoided, because this may cause defects such as the thermal cracks, etc. When the Thermistors are immersed into a cleaning solvent, make sure that the surface temperatures of the devices do not exceed 100 °C. Performing reflow soldering twice under the conditions shown in the figure above [Recommended profile of Reflow soldering (EX)] will not cause any problems. However, pay attention to the possible warp and bending of the PC board.

4.2 Hand Soldering

Hand soldering typically causes significant temperature change, which may induce excessive thermal stresses inside the Thermistors, resulting in the thermal cracks, etc. In order to prevent any defects, the following should be observed.

- The temperature of the soldering tips should be controlled with special care.
- The direct contact of soldering tips with the Thermistors and/or terminal electrodes should be avoided.
- Dismounted Thermistors shall not be reused.

(1) Condition 1 (with preheating)

(a) Soldering:

Use thread solder ($\phi 1$ mm or below) which contains flux with low chlorine, developed for precision electronic equipment.

(b) Preheating:

Conduct sufficient pre-heating, and make sure that the temperature difference between solder and Thermistors' surface is 150 °C or less.

(c) Temperature of Iron tip: 300 °C max.

(The required amount of solder shall be melted in advance on the soldering tip.)

(d) Gradual cooling:

After soldering, the Thermistors shall be cooled gradually at room temperature.

Recommended profile of Hand soldering (EX)

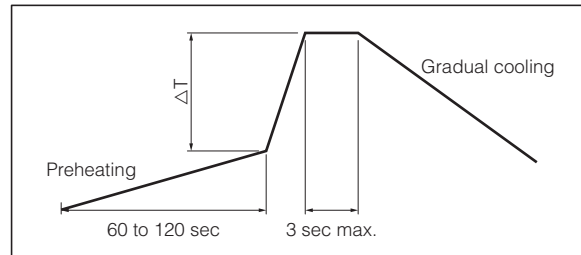

ΔT : Allowable temperature difference $\Delta T \leq 150 \text{ }^\circ\text{C}$

(2) Condition 2 (without preheating)

Hand soldering can be performed without preheating, by following the conditions below:

- Soldering iron tip shall never directly touch the ceramic and terminal electrodes of the Thermistors.
- The lands are sufficiently preheated with a soldering iron tip before sliding the soldering iron tip to the terminal electrodes of the Thermistors for soldering.

Conditions of Hand soldering without preheating

Item	Condition
Temperature of Iron tip	270 °C max.
Wattage	20 W max.
Shape of Iron tip	$\phi 3$ mm max.
Soldering time with a soldering iron	3 sec max.

5. Post Soldering Cleaning

5.1 Cleaning solvent

Soldering flux residue may remain on the PC board if cleaned with an inappropriate solvent. This may deteriorate the electrical characteristics and reliability of the Thermistors.

5.2 Cleaning conditions

Inappropriate cleaning conditions such as insufficient cleaning or excessive cleaning may impair the electrical characteristics and reliability of the Thermistors.

(1) Insufficient cleaning can lead to:

- The halogen substance found in the residue of the soldering flux may cause the metal of terminal electrodes to corrode.
- The halogen substance found in the residue of the soldering flux on the surface of the Thermistors may change resistance values.
- Water-soluble soldering flux may have more remarkable tendencies of (a) and (b) above compared to those of rosin soldering flux.