



Chipsmall Limited consists of a professional team with an average of over 10 year of expertise in the distribution of electronic components. Based in Hongkong, we have already established firm and mutual-benefit business relationships with customers from,Europe,America and south Asia,supplying obsolete and hard-to-find components to meet their specific needs.

With the principle of "Quality Parts,Customers Priority,Honest Operation,and Considerate Service",our business mainly focus on the distribution of electronic components. Line cards we deal with include Microchip,ALPS,ROHM,Xilinx,Pulse,ON,Everlight and Freescale. Main products comprise IC,Modules,Potentiometer,IC Socket,Relay,Connector.Our parts cover such applications as commercial,industrial, and automotives areas.

We are looking forward to setting up business relationship with you and hope to provide you with the best service and solution. Let us make a better world for our industry!



Contact us

Tel: +86-755-8981 8866 Fax: +86-755-8427 6832

Email & Skype: info@chipsmall.com Web: www.chipsmall.com

Address: A1208, Overseas Decoration Building, #122 Zhenhua RD., Futian, Shenzhen, China



Chip 3-Terminal Capacitor Array

Type: **EZASC**
EZANC

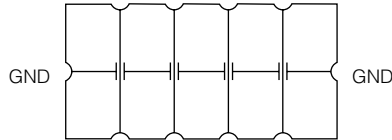

■ Features

1. Suitable for EMI suppression filtering
 - The low residual inductance at high frequency range provides effective reduction of noise
 - Equivalent noise reduction to the EMI filters with low cost design
 2. Compact design for high density PWB assembly
 - EZASC : 4.0 mm × 2.1 mm × 0.65 mm, 0.8 mm pitch
 - EZANC : 6.4 mm × 3.1 mm × 0.75 mm, 1.27 mm pitch
 - Flat and square packages suitable for high speed automatic placement machine
 3. Superior mountability with concave terminals
 - Firm solder joint (2 times that of convex terminal type)
 - Self-aligning placement during reflow soldering
- RoHS compliant

<Effect of high density placing, PWB space saving>

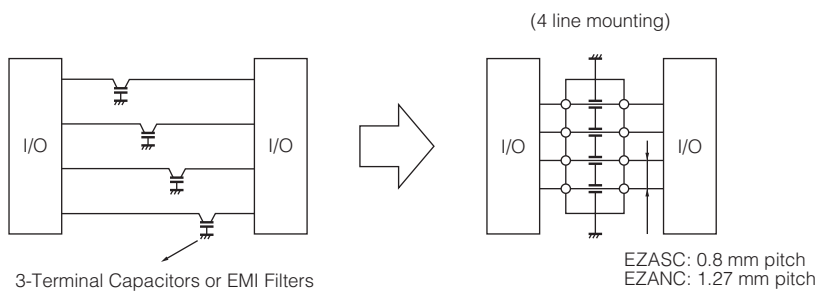

Digital cordless phone

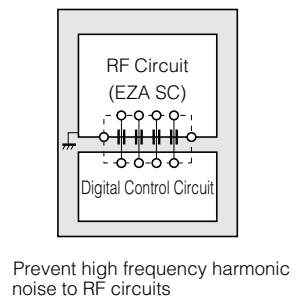

■ Recommended Applications

- Digital equipment such as PCs, printers, HDD, PCMCIA cards, PDAs, and word processors
- Communication equipment, digital cordless phones, automobile phones, GSM, PHS, DECT
- Digital audio and video equipment
- Electronic musical instruments, and other digital devices

Explanation of Part Number

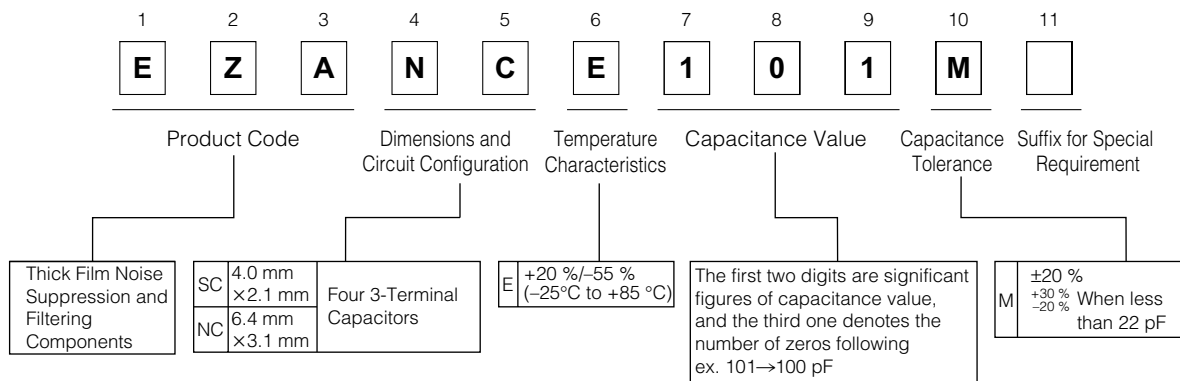

Construction

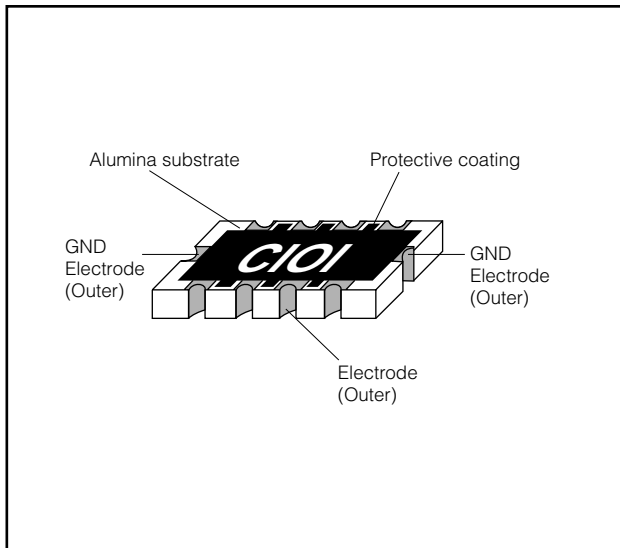

Circuit Configuration

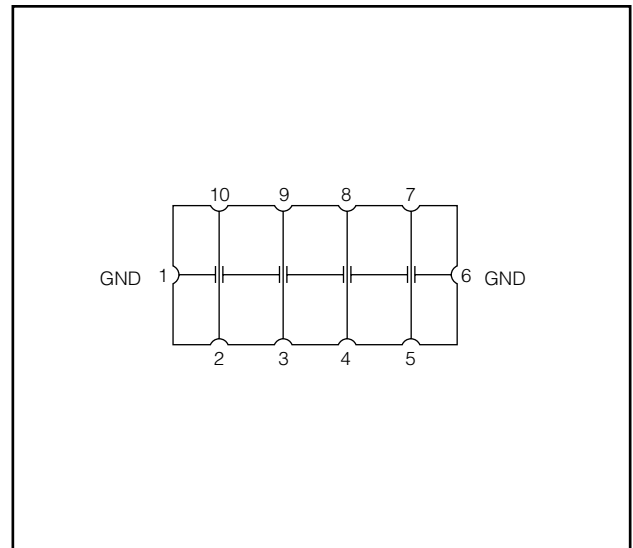

Dimensions in mm (not to scale)

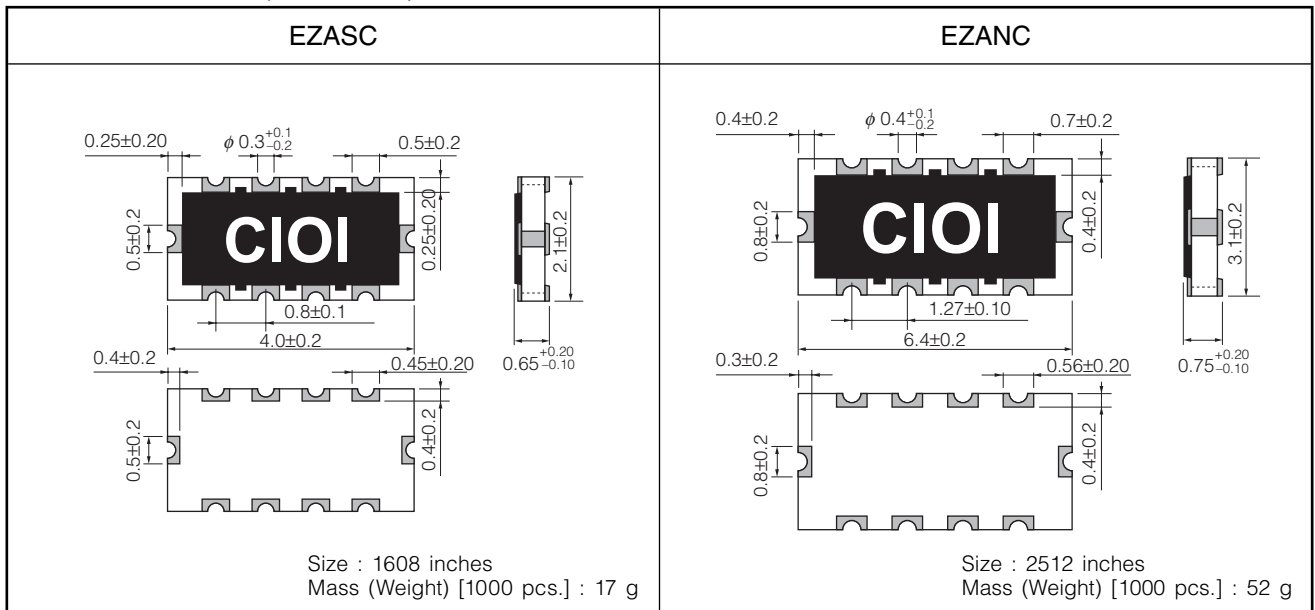

■ Ratings

Item	Specification	
	EZASC	EZANC
Capacitance Values (25 °C, 1 kHz ⁽¹⁾ , 1 Vrms)	10 pF to 180 pF Standard : 22 pF, 47 pF, 100 pF	22 pF, 47 pF, 100 pF, 220 pF, 470 pF
Capacitance Tolerance	±20% (^{+30%} / _{-20%} in the case of Less than 22 pF)	
Temperature Characteristic	E Characteristic: +20 %/±55 % (±25 °C to +85 °C)	
Dissipation Factor	Less than 2 % (25 °C, 1 kHz ⁽¹⁾ , 1 Vrms)	
Rated Voltage	25 V	
Rated Current ⁽²⁾	200 mA	300 mA
Resistance ⁽³⁾	Less than 1 Ω	
Category Temperature Range (Operating Temperature Range)	-25 °C to +85 °C	

(1) In measuring at 1 MHz, Capacitance Value and Dissipation Factor are different.

(2) Rated Current between Input terminal and Output terminal.

(3) Resistance value between Input terminal and Output terminal.

■ Attenuation Characteristics

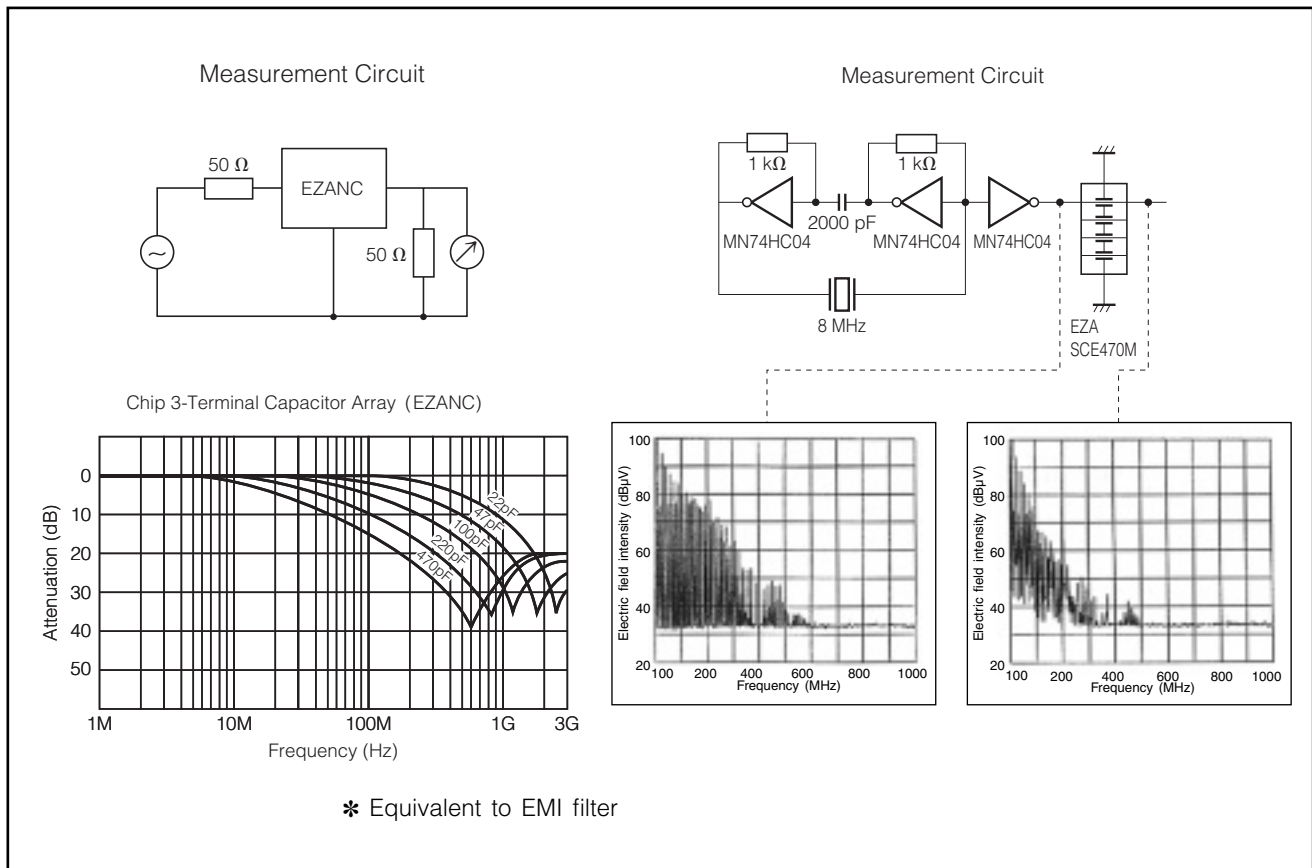

■ Packaging Methods (Taping)

● Standard Quantity

Type	Kind of Taping	Pitch (P ₁)	Quantity
EZASC	Embossed Carrier Taping	4 mm	4000 pcs./reel
EZANC			

● Embossed Carrier Taping

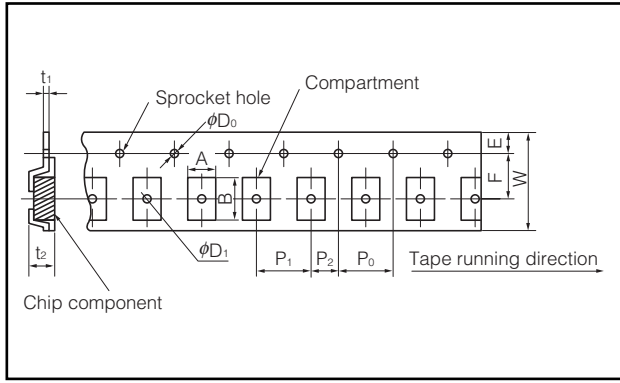

	Type	A	B	W	F	E	P ₀
Dimensions (mm)	EZASC	2.50 ^{+0.20}	4.40 ^{+0.20}	12.00 ^{+0.30}	5.50 ^{+0.20}	1.75 ^{+0.20}	4.00 ^{+0.10}
	EZANC	3.50 ^{+0.20}	6.80 ^{+0.20}				

	Type	P ₁	P ₂	φD ₀	t ₁	t ₂	φD ₁
Dimensions (mm)	EZASC	4.00 ^{+0.10}	2.00 ^{+0.05}	1.50 ^{+0.10}	0.25 ^{+0.05}	1.15 ^{+0.20}	1.50 ^{+0.10}
	EZANC					1.30 ^{+0.20}	

● Taping Reel

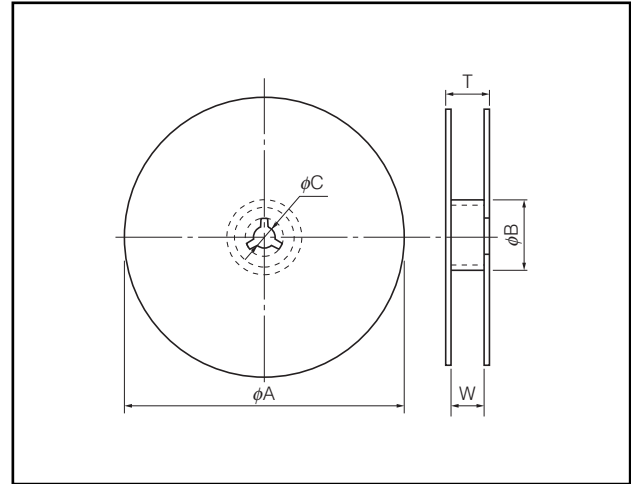

Dimensions (mm)	φA	φB	φC
	180 ⁺⁰ _{-3.0}	60 min.	13.0 ^{±1.0}

Dimensions (mm)	W	T
	13.0 ^{±1.0}	15.4 ^{±2.0}

■ Recommended Land Pattern Design

Chip 3-Terminal Capacitor Array (EZANC/EZASC)

Land pattern
 Solder resistant

	Type	a	b	c	d	e	f1	f2	P
Dimensions (mm)	EZASC	1.2 to 1.4	0.4	3.1 to 3.3	0.4 to 0.5	0.8	2.9 to 3.3	4.8 to 5.2	0.8
	EZANC	2.2 to 2.4	0.4 to 0.6	5.7 to 5.9	0.4 to 0.8	1.8	4.2 to 4.6	7.5 to 7.9	1.27

■ Recommended Soldering Conditions

Recommendations and precautions are described below.

- Recommended soldering conditions for reflow
 - Reflow soldering shall be performed a maximum of two times.
 - Please contact us for additional information when used in conditions other than those specified.
 - Please measure the temperature of the terminals and study every kind of solder and printed circuit board for solderability before actual use.

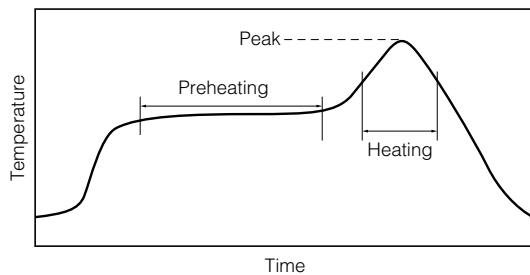

- Flow Soldering

We do not recommend flow soldering to the Chip 3-Terminal Capacitor Array: EZASC, because solder bridging may occur due to the narrow 0.8 mm pitch of EZASC. Please contact us regarding flow soldering of EZANC type.

For soldering (Example : Sn/Pb)

	Temperature	Time
Preheating	140 °C to 160 °C	60 s to 120 s
Main heating	Above 200 °C	30 s to 40 s
Peak	235 ± 5 °C	max. 10 s

For lead-free soldering (Example : Sn/Ag/Cu)

	Temperature	Time
Preheating	150 °C to 180 °C	60 s to 120 s
Main heating	Above 230 °C	30 s to 40 s
Peak	max. 260 °C	max. 10 s

⚠ Safety Precautions

The following are precautions for individual products. Please also refer to the precautions common to EMI Filters, Fuses, and Sensors(MR Elements) shown on page EX2 of this catalog.

1. Take measures against mechanical stress during and after mounting of Chip 3-Terminal Capacitor Array (hereafter called the capacitor arrays) so as not to damage their electrodes and protective coatings.
Be careful not to misplace the capacitor arrays on the land patterns. Otherwise, solder bridging may occur.
2. Do not use halogen-based or other high-activity flux. Otherwise, the residue may impair the capacitors arrays' performance and/or reliability.
3. When soldering with a soldering iron, never touch the capacitor arrays' bodies with the tip of the soldering iron. When using a soldering iron with a high temperature tip, finish soldering as quickly as possible (within three seconds at 350 °C max.).
4. As the amount of applied solder becomes larger, the mechanical stress applied to the capacitor arrays increases, causing problems such as cracks and faulty characteristics. Avoid applying an excessive amounts of solder.
5. Do not apply shock to the capacitor arrays or pinch them with a hard tool (e.g. pliers and tweezers). Otherwise, the capacitor arrays' protective coatings and bodies may be chipped, affecting their performance.
6. Avoid excessive bending of printed circuit boards in order to protect the capacitor arrays from abnormal stress.
7. The static capacitance may decrease by a few percent from the time of shipment due to the characteristics peculiar to dielectric materials having a high dielectric constant.

⚠ Safety Precautions (Common precautions for EMI Filters, Fuses, and Sensors[MR Elements])

- When using our products, no matter what sort of equipment they might be used for, be sure to make a written agreement on the specifications with us in advance. The design and specifications in this catalog are subject to change without prior notice.
- Do not use the products beyond the specifications described in this catalog.
- This catalog explains the quality and performance of the products as individual components. Before use, check and evaluate their operations when installed in your products.
- Install the following systems for a failsafe design to ensure safety if these products are to be used in equipment where a defect in these products may cause the loss of human life or other significant damage, such as damage to vehicles (automobile, train, vessel), traffic lights, medical equipment, aerospace equipment, electric heating appliances, combustion/gas equipment, rotating equipment, and disaster/crime prevention equipment.
- * Systems equipped with a protection circuit and a protection device
- * Systems equipped with a redundant circuit or other system to prevent an unsafe status in the event of a single fault

(1) Precautions for use

- These products are designed and manufactured for general and standard use in general electronic equipment (e.g. AV equipment, home electric appliances, office equipment, information and communication equipment)
- These products are not intended for use in the following special conditions. Before using the products, carefully check the effects on their quality and performance, and determine whether or not they can be used.
 1. In liquid, such as water, oil, chemicals, or organic solvent
 2. In direct sunlight, outdoors, or in dust
 3. In salty air or air with a high concentration of corrosive gas, such as Cl₂, H₂S, NH₃, SO₂, or NO₂
 4. Electric Static Discharge (ESD) Environment
These components are sensitive to static electricity and can be damaged under static shock (ESD). Please take measures to avoid any of these environments.
Smaller components are more sensitive to ESD environment.
 5. Electromagnetic Environment
Avoid any environment where strong electromagnetic waves exist.
 6. In an environment where these products cause dew condensation
 7. Sealing or coating of these products or a printed circuit board on which these products are mounted, with resin or other materials
- These products generate Joule heat when energized. Carefully position these products so that their heat will not affect the other components.
- Carefully position these products so that their temperatures will not exceed the category temperature range due to the effects of neighboring heat-generating components. Do not mount or place heat-generating components or inflammables, such as vinyl-coated wires, near these products (except Thermal Cutoffs).
- Note that non-cleaning solder, halogen-based highly active flux, or water-soluble flux may deteriorate the performance or reliability of the products.
- Carefully select a flux cleaning agent for use after soldering. An unsuitable agent may deteriorate the performance or reliability. In particular, when using water or a water-soluble cleaning agent, be careful not to leave water residues. Otherwise, the insulation performance may be deteriorated.

(2) Precautions for storage

The performance of these products, including the solderability, is guaranteed for a year from the date of arrival at your company, provided that they remain packed as they were when delivered and stored at a temperature of 5 °C to 35 °C and a relative humidity of 45 % to 85 %. (Micro Chip Fuses: Guaranteed for 6 months from the date of arrival at your company)

The performance of EMI Filters is guaranteed for 6 months or a year from the outgoing inspection date indicated on the packages, provided that they are stored at a temperature of -5 °C to +40 °C and a relative humidity of 40 % to 60 %. Check the guarantee period in the specifications. The performance of Thermal Cutoffs is guaranteed for a year from the outgoing inspection date indicated on the packages, provided that they are stored at a temperature of -10 °C to +40 °C and a relative humidity of 30 % to 75 %.

Even within the above guarantee periods, do not store these products in the following conditions. Otherwise, their electrical performance and/or solderability may be deteriorated, and the packaging materials (e.g. taping materials) may be deformed or deteriorated, resulting in mounting failures.

1. In salty air or in air with a high concentration of corrosive gas, such as Cl₂, H₂S, NH₃, SO₂, or NO₂
2. In direct sunlight

<Package markings>

Package markings include the product number, quantity, and country of origin. In principle, the country of origin should be indicated in English.