



Chipsmall Limited consists of a professional team with an average of over 10 year of expertise in the distribution of electronic components. Based in Hongkong, we have already established firm and mutual-benefit business relationships with customers from,Europe,America and south Asia,supplying obsolete and hard-to-find components to meet their specific needs.

With the principle of “Quality Parts,Customers Priority,Honest Operation,and Considerate Service”,our business mainly focus on the distribution of electronic components. Line cards we deal with include Microchip,ALPS,ROHM,Xilinx,Pulse,ON,Everlight and Freescale. Main products comprise IC,Modules,Potentiometer,IC Socket,Relay,Connector.Our parts cover such applications as commercial,industrial, and automotives areas.

We are looking forward to setting up business relationship with you and hope to provide you with the best service and solution. Let us make a better world for our industry!



Contact us

Tel: +86-755-8981 8866 Fax: +86-755-8427 6832

Email & Skype: info@chipsmall.com Web: www.chipsmall.com

Address: A1208, Overseas Decoration Building, #122 Zhenhua RD., Futian, Shenzhen, China



ANGELINA-M

~30° medium beam

TECHNICAL SPECIFICATIONS:

Dimensions	Ø 82.0 mm
Height	31 mm
Fastening	socket
Colour	metal
Box size	480 x 280 x 300 mm
Box weight	11 kg
Quantity in Box	900 pcs
ROHS compliant	yes ⓘ



MATERIAL SPECIFICATIONS:

Component	Type	Material	Colour	Coating
ANGELINA-M	Reflector	PC	metal	HMDS

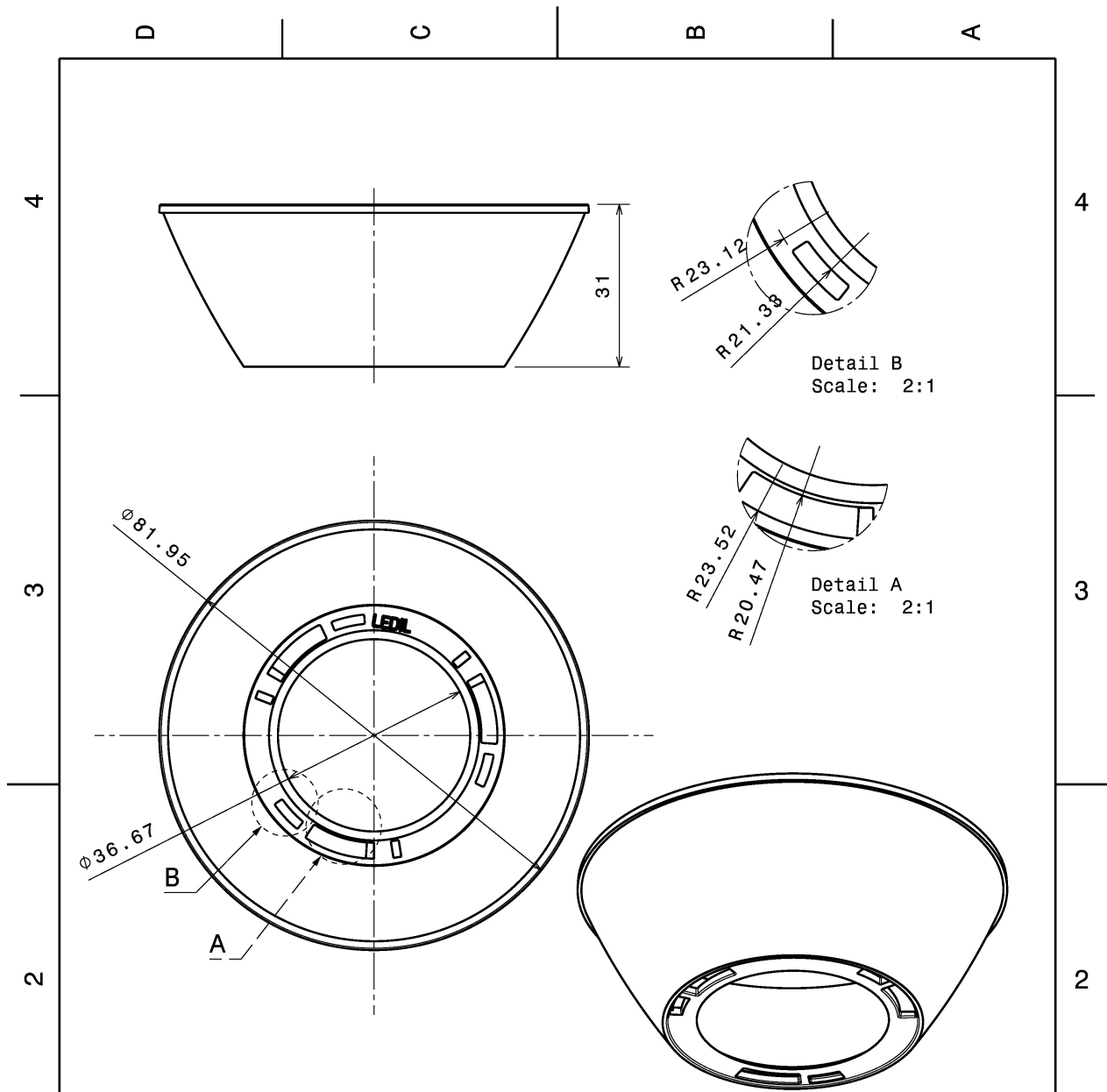

INDEX	PART NO	DESCRIPTION	MATERIAL	COLOUR
1		ANGELINA	PC	metal

Tolerances if not otherwise shown
According to DIN ISO 2768-1
Linear measures:
Up to 30mm class M, otherwise class C.
According to DIN ISO 2768-2
Form and position: class L



Ledil Oy
Salorankatu 10
FIN 24240 SALO
Finland

THIRD ANGLE PROJECTION:

DRAWING TITLE

ANGELINA series Reflector

This drawing is the property of LEDiL Oy. It may not be reproduced, copied or communicated without a written agreement with LEDiL Oy."

SIZE PART NUMBER

A4



-

SCALE 1:1 WEIGHT

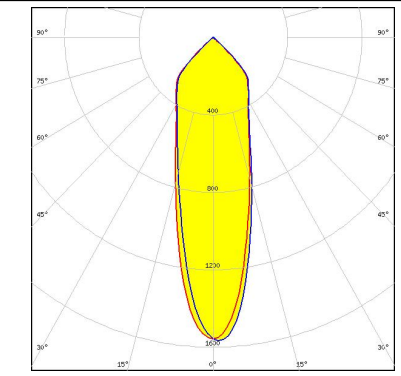
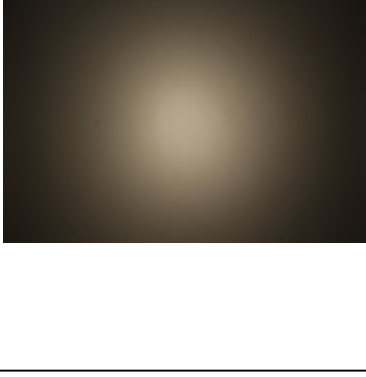
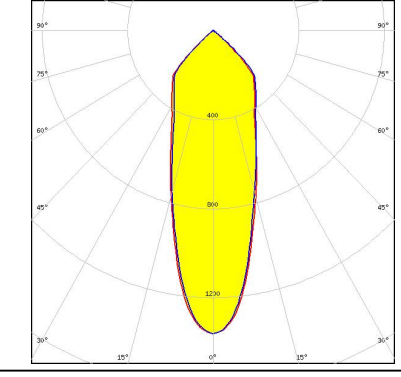
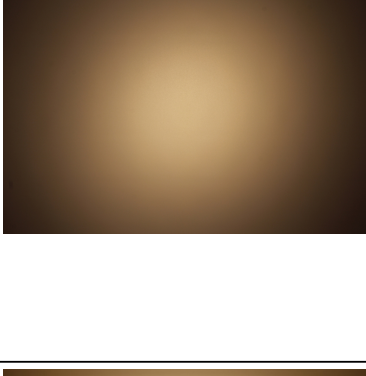

-

SHEET 1/1

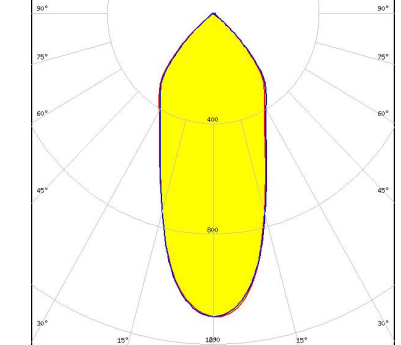

PHOTOMETRIC DATA (MEASURED):

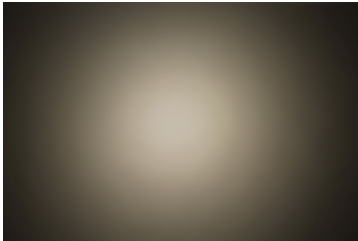
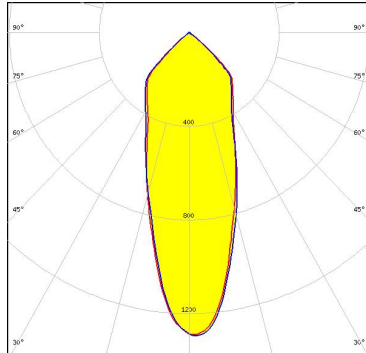
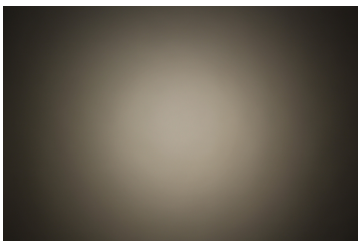
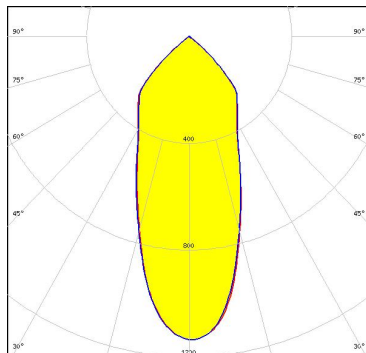
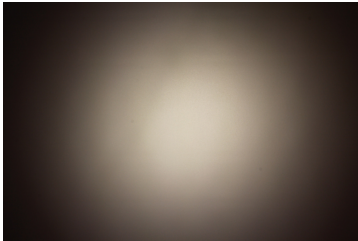
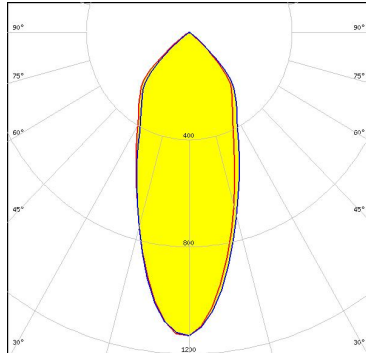
<p>bridgelux.</p> <p>LED BXRA ES Rectangle</p> <p>FWHM 30.0°</p> <p>Efficiency 93 %</p> <p>Peak intensity 1.570 cd/lm</p> <p>Required components: IDEAL: 50-2100BL + 50-2100AN</p>		
<p>bridgelux.</p> <p>LED V13 Gen7</p> <p>FWHM 34.0°</p> <p>Efficiency 92 %</p> <p>Peak intensity 1.400 cd/lm</p> <p>Required components: TE: 2213254-2 + OPTIC CLIP Z50 TYPE1 2213194-1</p>		
<p>bridgelux.</p> <p>LED V15 Gen6</p> <p>FWHM 37.0°</p> <p>Efficiency 92 %</p> <p>Peak intensity 1.400 cd/lm</p> <p>Required components: C13658_CLAMP-VERO13-18 Bender Wirth: 456 Typ L2</p>		
<p>bridgelux.</p> <p>LED V22 Gen6</p> <p>FWHM 43.0°</p> <p>Efficiency 91 %</p> <p>Peak intensity 1.100 cd/lm</p> <p>Required components: IDEAL: 50-2204-CT + 50-2100AN</p>		

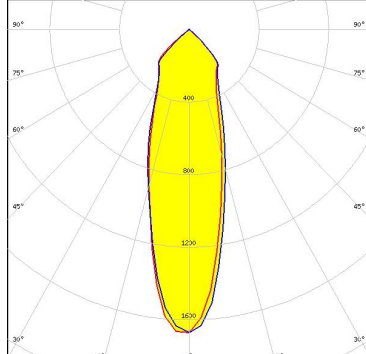
PHOTOMETRIC DATA (MEASURED):

<p>bridgelux.</p> <p>LED Vero SE 13</p> <p>FWHM 36.0°</p> <p>Efficiency 93 %</p> <p>Peak intensity 1.300 cd/lm</p> <p>Required components:</p> <p> C16402_CLAMP-VEROSE-13-18</p>		
<p>bridgelux.</p> <p>LED Vero SE 18</p> <p>FWHM 42.0°</p> <p>Efficiency 93 %</p> <p>Peak intensity 1.100 cd/lm</p> <p>Required components:</p> <p> C16402_CLAMP-VEROSE-13-18</p>		
<p>bridgelux.</p> <p>LED VERO13</p> <p>FWHM 42.0°</p> <p>Efficiency 87 %</p> <p>Peak intensity 1.130 cd/lm</p> <p>Required components:</p> <p> C13658_CLAMP-VERO13-18</p> <p> F13671_ANGE-RZ-LENS</p>		
<p>bridgelux.</p> <p>LED VERO13</p> <p>FWHM 31.0°</p> <p>Efficiency 92 %</p> <p>Peak intensity 1.700 cd/lm</p> <p>Required components:</p> <p> C13658_CLAMP-VERO13-18</p>		

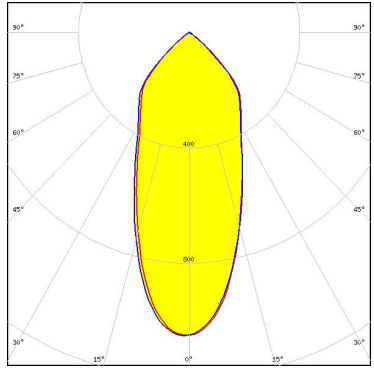
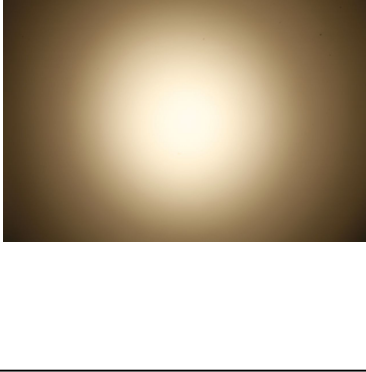
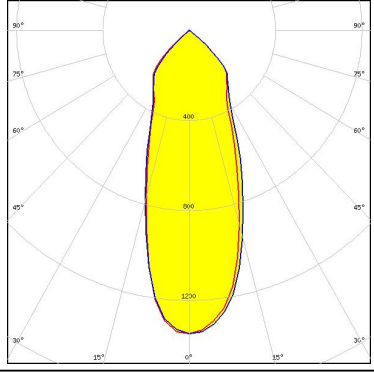
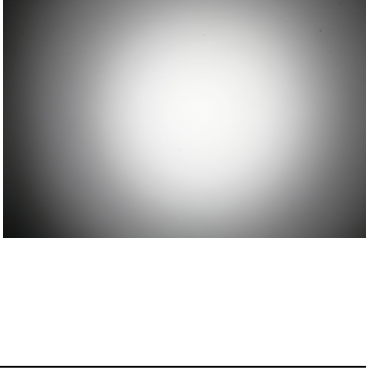
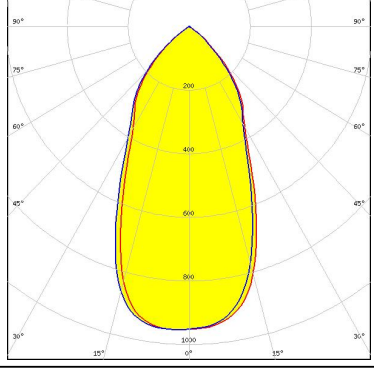
PHOTOMETRIC DATA (MEASURED):

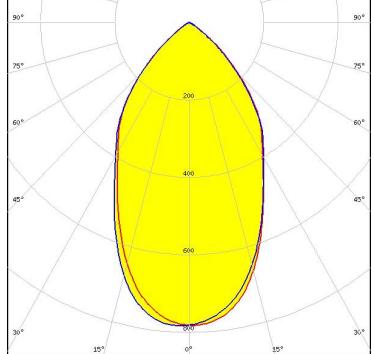
<p>bridgelux.</p> <p>LED VERO18</p> <p>FWHM 43.0°</p> <p>Efficiency 89 %</p> <p>Peak intensity 1.050 cd/lm</p> <p>Required components:</p> <p>C13658_CLAMP-VERO13-18</p> <p>F13671_ANGE-RZ-LENS</p>		
<p>bridgelux.</p> <p>LED VERO18</p> <p>FWHM 38.0°</p> <p>Efficiency 92 %</p> <p>Peak intensity 1.400 cd/lm</p> <p>Required components:</p> <p>C13658_CLAMP-VERO13-18</p>		
<p>bridgelux.</p> <p>LED VERO29</p> <p>FWHM 51.0°</p> <p>Efficiency 90 %</p> <p>Peak intensity 1.000 cd/lm</p> <p>Required components:</p> <p>C13584_CLAMP-VERO29</p>		
<p>bridgelux.</p> <p>LED VERO29</p> <p>FWHM 60.0°</p> <p>Efficiency 87 %</p> <p>Peak intensity 0.780 cd/lm</p> <p>Required components:</p> <p>C13584_CLAMP-VERO29</p> <p>F13671_ANGE-RZ-LENS</p>		

PHOTOMETRIC DATA (MEASURED):

CITIZEN

LED CLL02x/CLU02x (LES10)
FWHM 31.0°
Efficiency 92 %
Peak intensity 1.400 cd/lm
Required components:
C13658_CLAMP-VERO13-18
Bender Wirth: 434 Typ L1

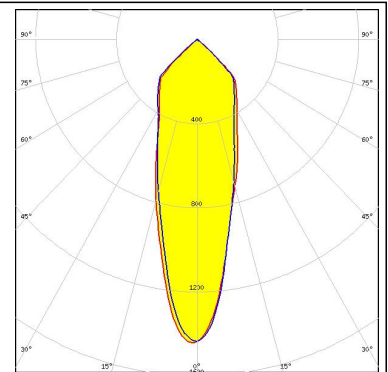
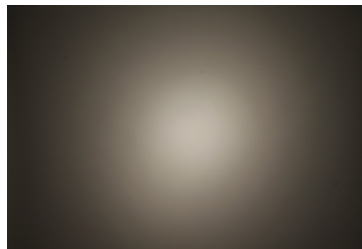

CITIZEN

LED CLL03x/CLU03x
FWHM 30.0°
Efficiency 92 %
Peak intensity 1.550 cd/lm
Required components:
IDEAL: 50-2103CT + 50-2100AN

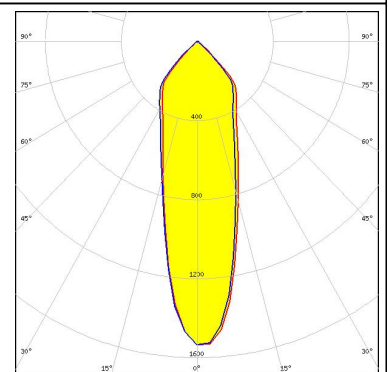
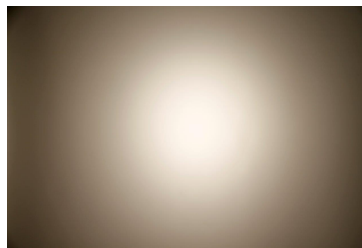

CITIZEN

LED CLL03x/CLU03x
FWHM 35.0°
Efficiency 94 %
Peak intensity 1.400 cd/lm
Required components:
TE: 2213254-2 + OPTIC CLIP Z50 TYPE1 2213194-1

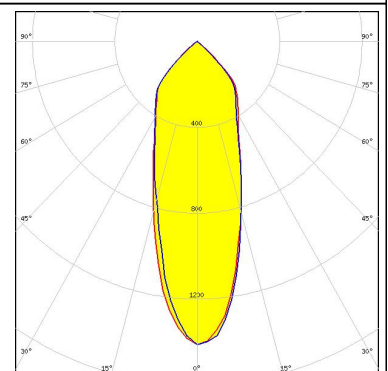
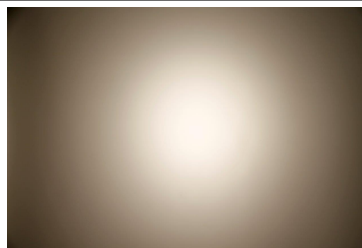

CITIZEN

LED CLL03x/CLU03x
FWHM 37.0°
Efficiency 91 %
Peak intensity 1.300 cd/lm
Required components:
C13658_CLAMP-VERO13-18
Bender Wirth: 433 Typ L1

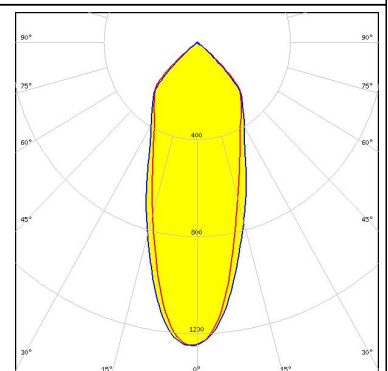
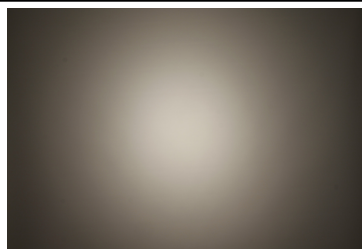

PHOTOMETRIC DATA (MEASURED):

CITIZEN

LED CLL04x/CLU04x
FWHM 43.0°
Efficiency 91 %
Peak intensity 1.100 cd/lm
Required components:
IDEAL: 50-2204-CT + 50-2100AN

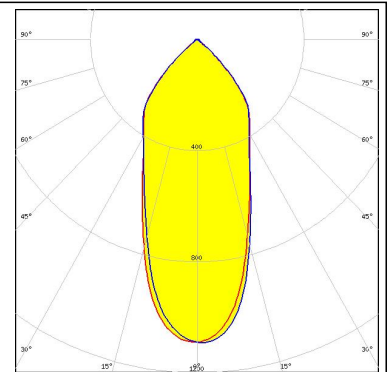
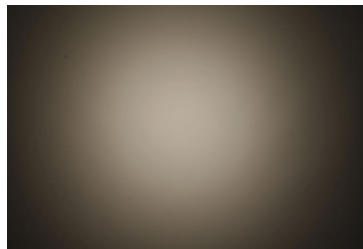

CITIZEN

LED CLL04x/CLU04x
FWHM 42.0°
Efficiency 92 %
Peak intensity 1.100 cd/lm
Required components:
C13584_CLAMP-VERO29
Bender Wirth: 431 Typ L3

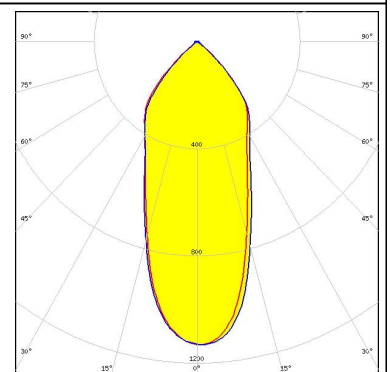
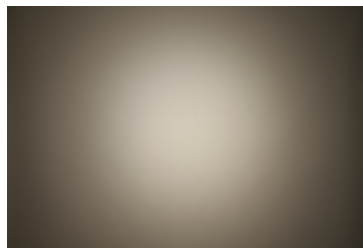

CITIZEN

LED CLU700/701
FWHM 26.0°
Efficiency 92 %
Peak intensity 1.600 cd/lm
Required components:
C13658_CLAMP-VERO13-18
Bender Wirth: 434 Typ L1

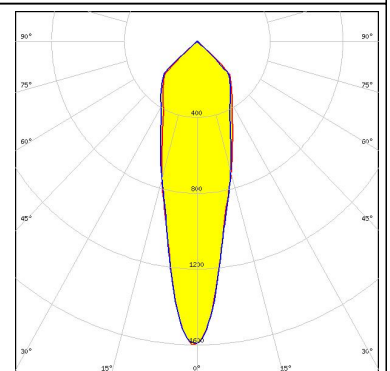
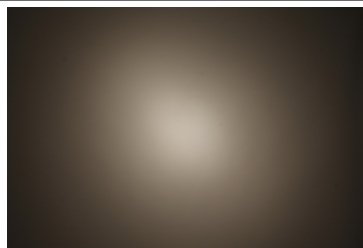

CITIZEN

LED CLU720/721
FWHM 33.0°
Efficiency 91 %
Peak intensity 1.400 cd/lm
Required components:
C13658_CLAMP-VERO13-18

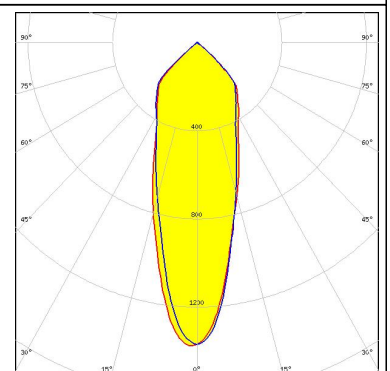
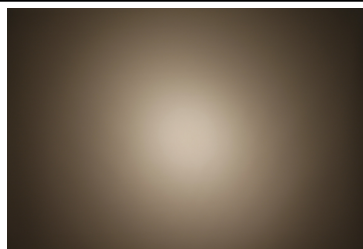

PHOTOMETRIC DATA (MEASURED):

CITIZEN

LED CLU720/721

FWHM 31.0°

Efficiency 94 %

Peak intensity 1.400 cd/lm

Required components:

TE: 2213254-2 + OPTIC CLIP Z50 TYPE1 2213194-1

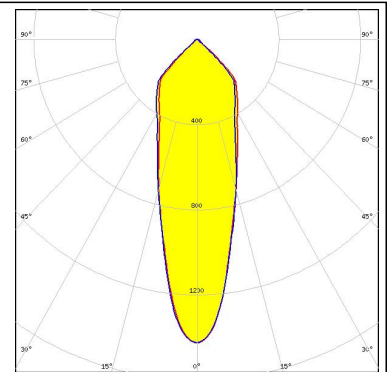
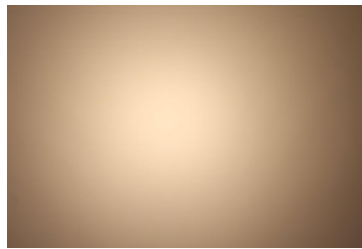

CITIZEN

LED CLU720/721

FWHM 26.0°

Efficiency 93 %

Peak intensity 1.600 cd/lm

Required components:

IDEAL: 50-2103CT + 50-2100AN

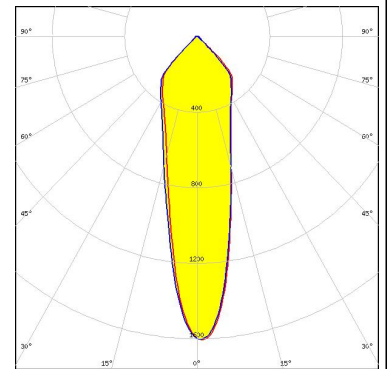
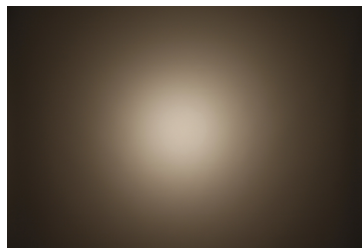

CITIZEN

LED CLU730/731

FWHM 31.0°

Efficiency 91 %

Peak intensity 1.400 cd/lm

Required components:

IDEAL: 50-2204-CT + 50-2100AN

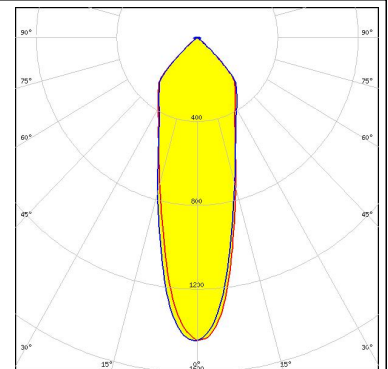
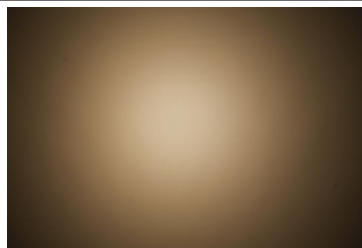

CREE

LED CMA2550

FWHM 42.0°

Efficiency 94 %

Peak intensity 1.200 cd/lm

Required components:

C14036_CLAMP_CXA25-30

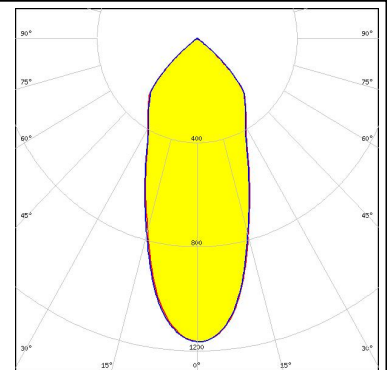
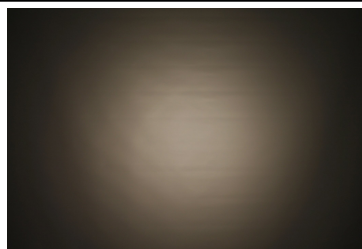

PHOTOMETRIC DATA (MEASURED):



LED CMA3090
 FWHM 46.0°
 Efficiency 94 %
 Peak intensity 1.100 cd/lm
 Required components:
 C14036_CLAMP_CXA25-30

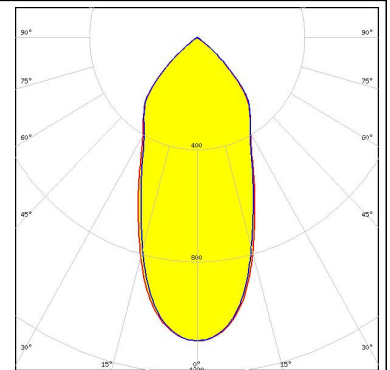
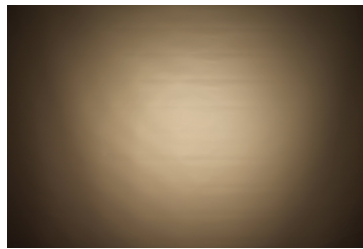

LED CXA/B 15xx
 FWHM 28.0°
 Efficiency 92 %
 Peak intensity 1.500 cd/lm
 Required components:
 C13658_CLAMP-VERO13-18
 Bender Wirth: 441 Typ L1

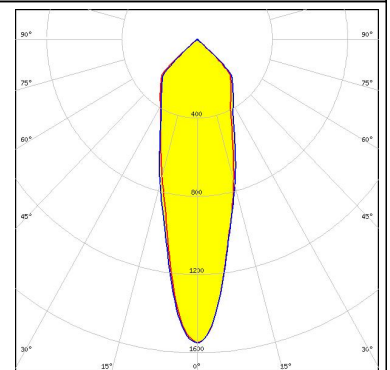
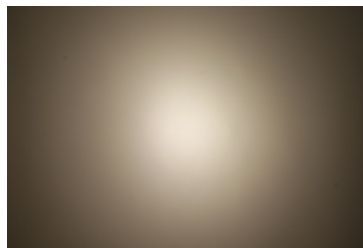

LED CXA/B 15xx
 FWHM 33.0°
 Efficiency 94 %
 Peak intensity 1.500 cd/lm
 Required components:
 C14123_CLAMP-CXA15-18

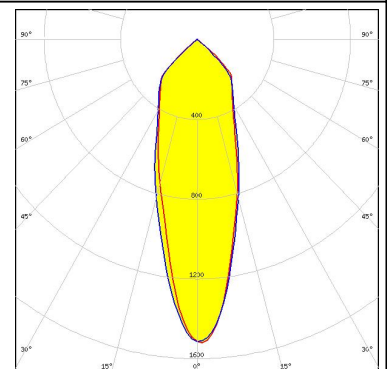
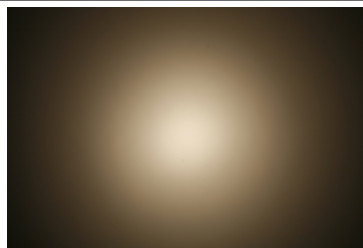

LED CXA/B 1816 & CXA/B 1820 & CXA 1850
 FWHM 36.0°
 Efficiency 91 %
 Peak intensity 1.300 cd/lm
 Required components:
 C13658_CLAMP-VERO13-18
 Bender Wirth: 437 Typ L1

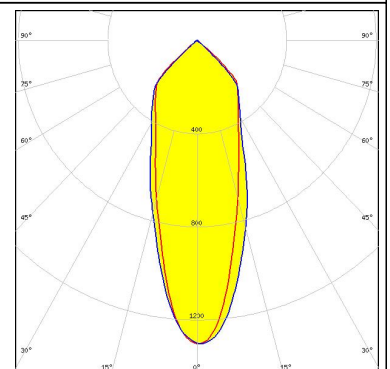
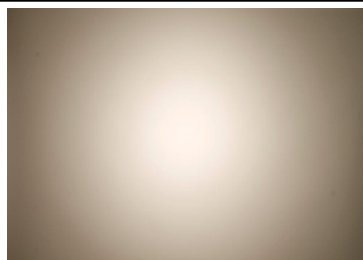

PHOTOMETRIC DATA (MEASURED):



LED CXA/B 1816 & CXA/B 1820 & CXA 1850
 FWHM 26.0°
 Efficiency 93 %
 Peak intensity 1.700 cd/lm
 Required components:
 IDEAL: 50-2101CR + 50-2100AN

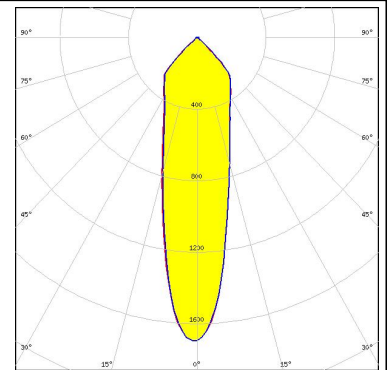
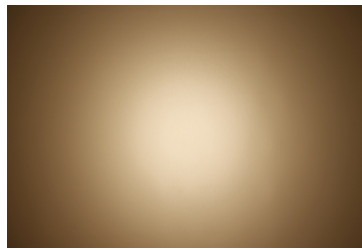

LED CXA/B 1816 & CXA/B 1820 & CXA 1850
 FWHM 37.0°
 Efficiency 94 %
 Peak intensity 1.400 cd/lm
 Required components:
 C14123_CLAMP-CXA15-18

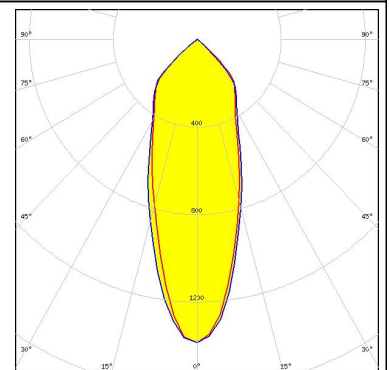
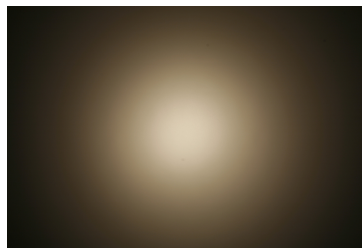

LED CXA/B 25xx
 FWHM 42.0°
 Efficiency 92 %
 Peak intensity 1.100 cd/lm
 Required components:
 C14036_CLAMP_CXA25-30

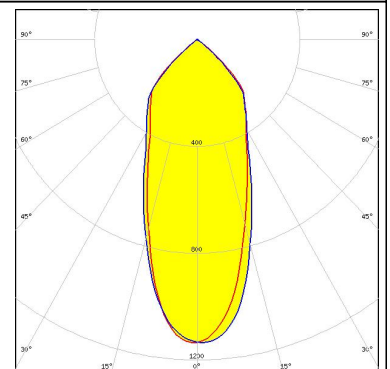
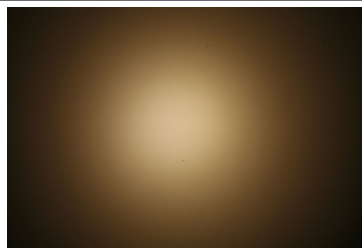

LED CXA/B 25xx
 FWHM 34.0°
 Efficiency 93 %
 Peak intensity 1.370 cd/lm
 Required components:
 IDEAL: 50-2102CR + 50-2100AN

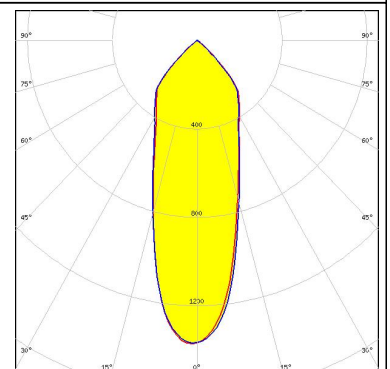
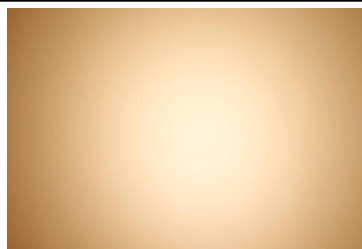

PHOTOMETRIC DATA (MEASURED):

CREE 

LED CXA/B 30xx
 FWHM 40.0°
 Efficiency 93 %
 Peak intensity 1.180 cd/lm
 Required components:
 IDEAL: 50-2234C + 50-2100AN

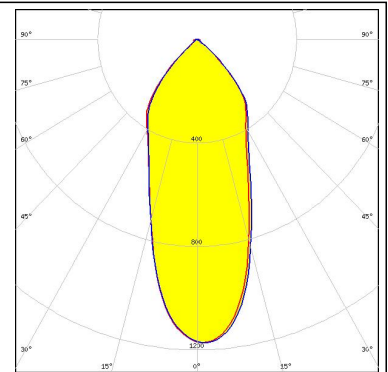
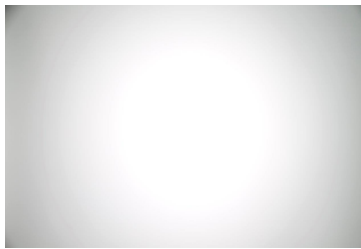

CREE 

LED CXA/B 30xx
 FWHM 48.0°
 Efficiency 91 %
 Peak intensity 1.000 cd/lm
 Required components:
 C14036_CLAMP_CXA25-30

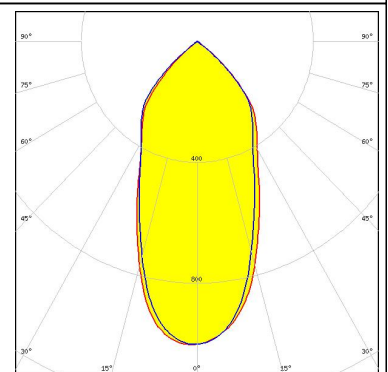
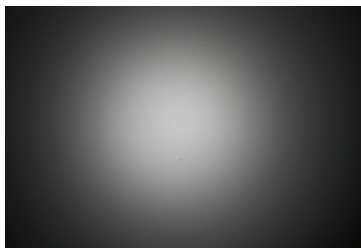

CREE 

LED CXA/B 3590
 FWHM 54.0°
 Efficiency 92 %
 Peak intensity 0.910 cd/lm
 Required components:
 IDEAL: 50-2303CR + 50-2300AN

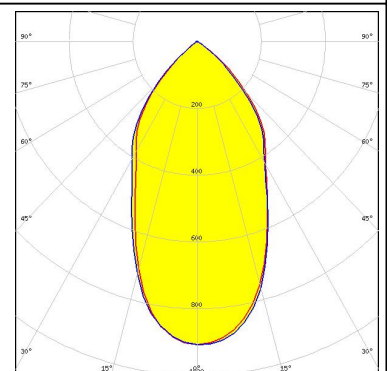
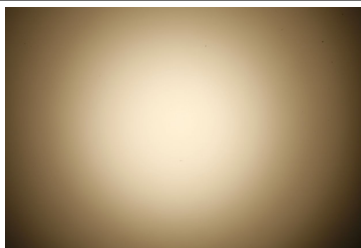

EVERLIGHT

LED CHI3030 19W
 FWHM 43.0°
 Efficiency 87 %
 Peak intensity 1.000 cd/lm
 Required components:
 C13584_CLAMP-VERO29
 F13671_ANGE-RZ-LENS
 Bender Wirth: 468 Typ L3

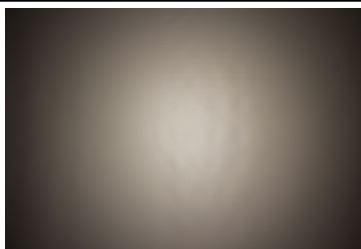

PHOTOMETRIC DATA (MEASURED):

EVERLIGHT

LED CHI3030 29W
 FWHM 52.0°
 Efficiency 87 %
 Peak intensity 1.000 cd/lm
 Required components:
 C13584_CLAMP-VERO29
 F13671_ANGE-RZ-LENS
 Bender Wirth: 468 Typ L3

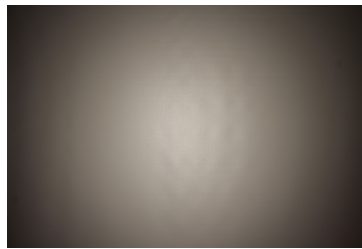

LG Innotek

LED COB 10W/13W/17W/24W
 FWHM 28.0°
 Efficiency 92 %
 Peak intensity 1.640 cd/lm
 Required components:
 IDEAL: 50-2100LG + 50-2100AN

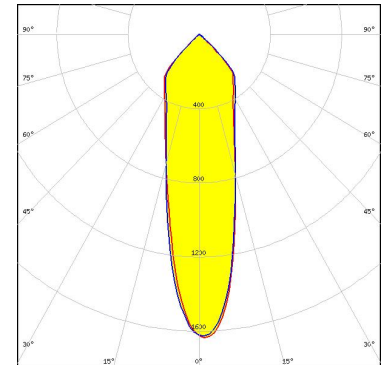
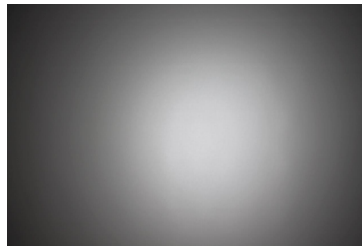

LUMILEDS

LED LUXEON CoB 1202/1203
 FWHM 32.0°
 Efficiency 92 %
 Peak intensity 1.400 cd/lm
 Required components:
 C13658_CLAMP-VERO13-18
 Bender Wirth: 438 Typ L1

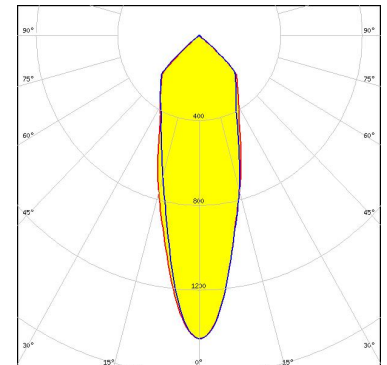
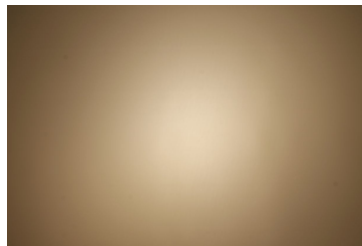

LUMILEDS

LED LUXEON CoB 1204/1205
 FWHM 28.0°
 Efficiency 92 %
 Peak intensity 1.610 cd/lm
 Required components:
 IDEAL: 50-2100SH + 50-2100AN

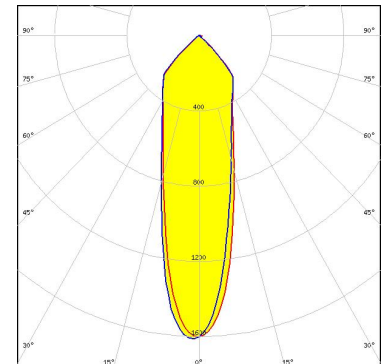
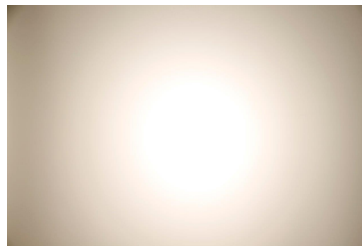

PHOTOMETRIC DATA (MEASURED):

LUMILEDS

LED LUXEON CoB 1204/1205

FWHM 30.0°

Efficiency 94 %

Peak intensity 1.800 cd/lm

Required components:

TE: 2213130-2 + OPTIC CLIP Z50 TYPE1 2213194-1

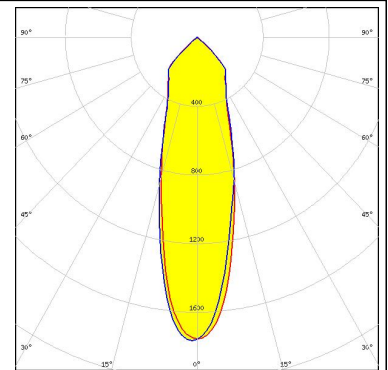
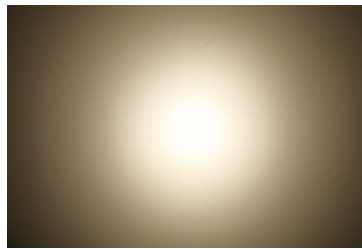

LUMILEDS

LED LUXEON CoB 1208

FWHM 31.0°

Efficiency 93 %

Peak intensity 1.500 cd/lm

Required components:

IDEAL: 50-2100SH + 50-2100AN

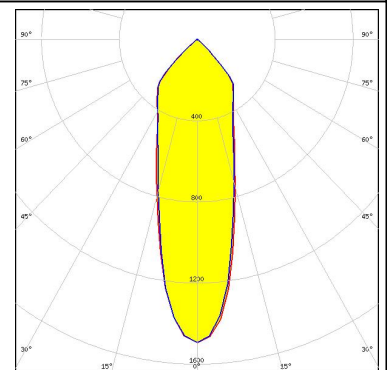
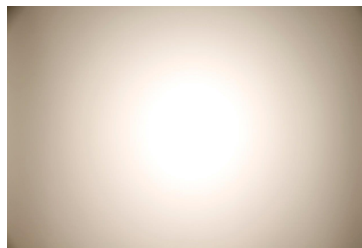

LUMILEDS

LED LUXEON CoB 1208

FWHM 32.0°

Efficiency 93 %

Peak intensity 1.600 cd/lm

Required components:

TE: 2213130-2 + OPTIC CLIP Z50 TYPE1 2213194-1

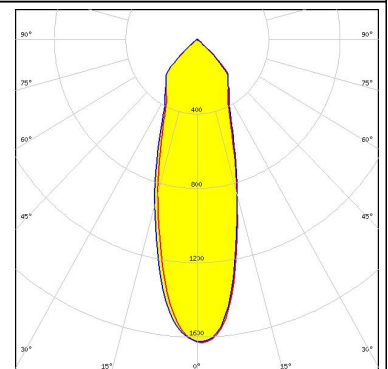
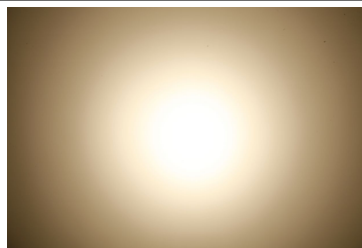

LUMILEDS

LED LUXEON CoB 1211

FWHM 39.0°

Efficiency 91 %



Peak intensity 1.200 cd/lm

Required components:

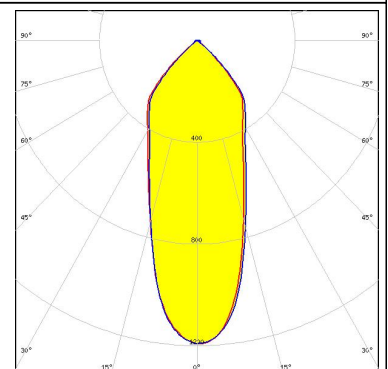
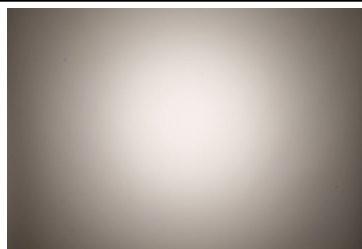
IDEAL: 50-2204-CT + 50-2100AN

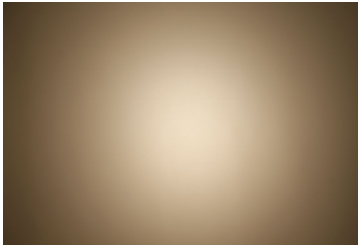
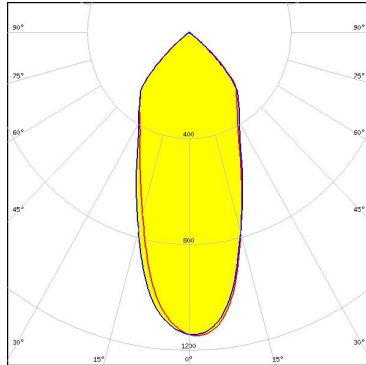
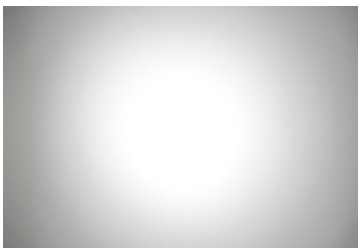
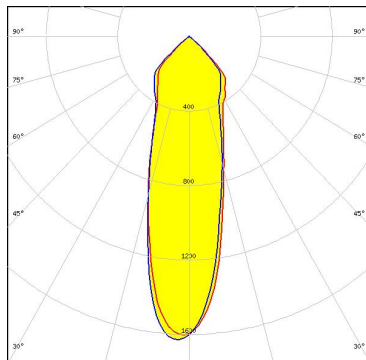

PHOTOMETRIC DATA (MEASURED):

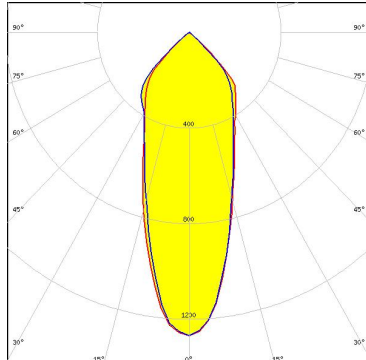
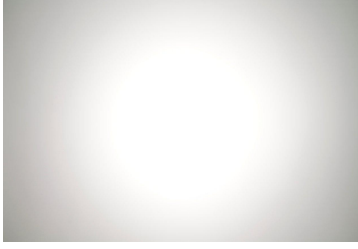
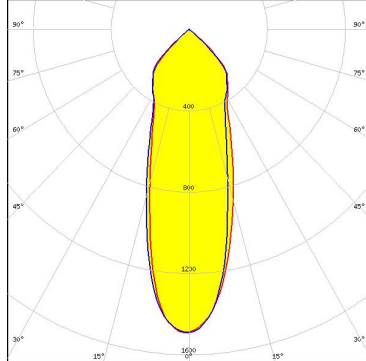
<p>LUMILEDS</p> <p>LED LUXEON CoB 1211</p> <p>FWHM 42.0°</p> <p>Efficiency 92 %</p> <p>Peak intensity 1.100 cd/lm</p> <p>Required components: C13584_CLAMP-VERO29 Bender Wirth: 431 Typ L3</p>		
<p>LUMILEDS</p> <p>LED LUXEON K12</p> <p>FWHM 29.0°</p> <p>Efficiency 94 %</p> <p>Peak intensity 1.600 cd/lm</p> <p>Required components: TE: 2213134-2 + OPTIC CLIP Z50 TYPE1 2213194-1</p>		
<p>LUMILEDS</p> <p>LED LUXEON K12</p> <p>FWHM 37.0°</p> <p>Efficiency 89 %</p> <p>Peak intensity 1.300 cd/lm</p> <p>Required components: F13671_ANGE-RZ-LENS TE: 2213134-2 + OPTIC CLIP Z50 TYPE1 2213194-1</p>		
<p>LUMILEDS</p> <p>LED LUXEON K16</p> <p>FWHM 32.0°</p> <p>Efficiency 94 %</p> <p>Peak intensity 1.500 cd/lm</p> <p>Required components: TE: 2213134-2 + OPTIC CLIP Z50 TYPE1 2213194-1</p>		

PHOTOMETRIC DATA (MEASURED):

LUMILEDS

LED LUXEON K16

FWHM 43.0°

Efficiency 89 %

Peak intensity 1.100 cd/lm

Required components:

F13671_ANGE-RZ-LENS

TE: 2213134-2 + OPTIC CLIP Z50 TYPE1 2213194-1

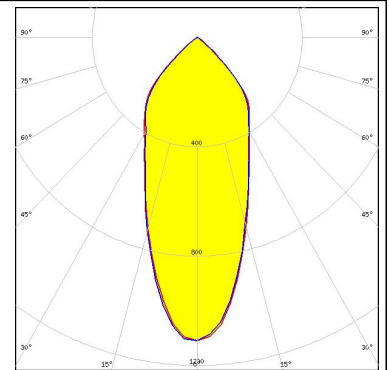

LUMILEDS

LED LUXEON S2000

FWHM 25.0°

Efficiency 92 %

Peak intensity 2.000 cd/lm

Required components:

C13395_CLAMP-S2000

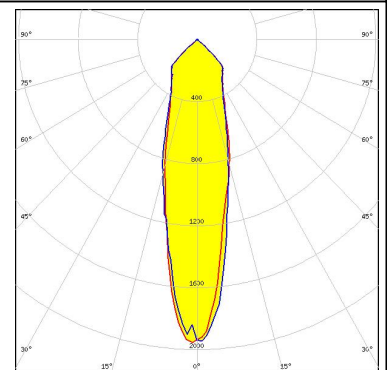
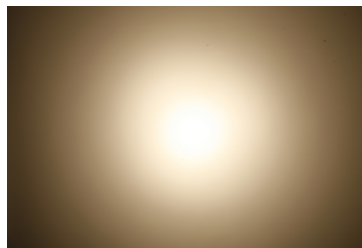

LUMILEDS

LED LUXEON S3000

FWHM 28.0°

Efficiency 92 %

Peak intensity 1.800 cd/lm

Required components:

C13397_CLAMP-S3000

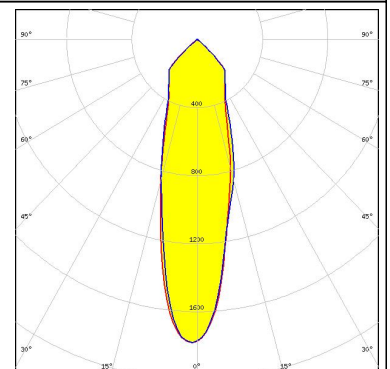
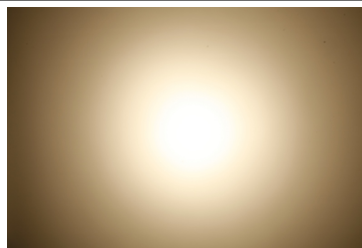

LUMILEDS

LED LUXEON S5000

FWHM 33.0°

Efficiency 92 %

Peak intensity 1.500 cd/lm

Required components:

C13399_CLAMP-S5000

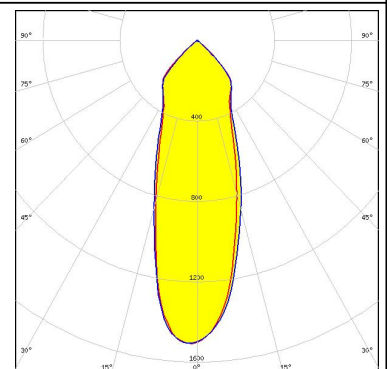

PHOTOMETRIC DATA (MEASURED):



LED CDM-14 (Dim-To-Warm)
 FWHM 40.0°
 Efficiency 88 %
 Peak intensity 1.100 cd/lm
 Required components:
 C13658_CLAMP-VERO13-18
 F13671_ANGE-RZ-LENS
 Bender Wirth: 491 Typ L2

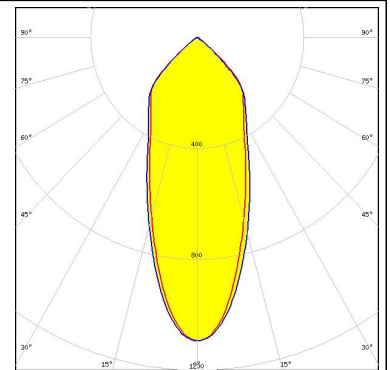

LED CDM-14 (Dim-To-Warm)
 FWHM 36.0°
 Efficiency 92 %
 Peak intensity 1.300 cd/lm
 Required components:
 C13658_CLAMP-VERO13-18
 Bender Wirth: 491 Typ L2

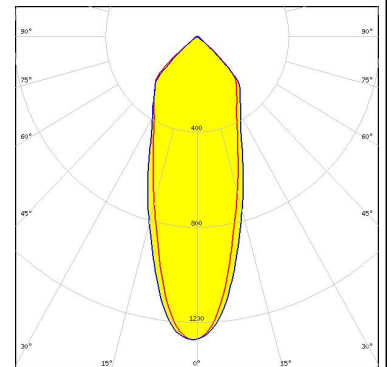
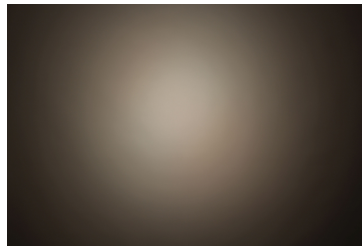

LED CDM-18 (Dim-To-Warm)
 FWHM 43.0°
 Efficiency 89 %
 Peak intensity 1.000 cd/lm
 Required components:
 C13658_CLAMP-VERO13-18
 F13671_ANGE-RZ-LENS
 Bender Wirth: 491 Typ L2

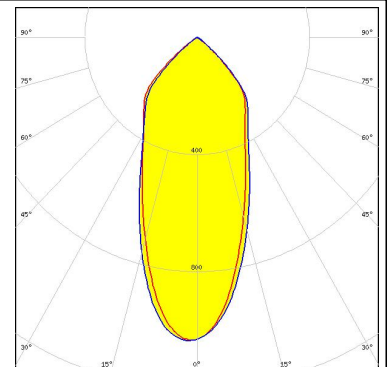
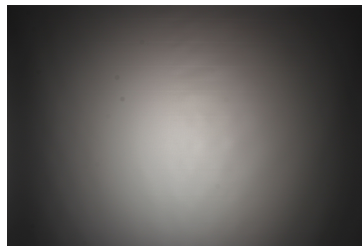

LED CDM-18 (Dim-To-Warm)
 FWHM 40.0°
 Efficiency 93 %
 Peak intensity 1.200 cd/lm
 Required components:
 C13658_CLAMP-VERO13-18
 Bender Wirth: 491 Typ L2

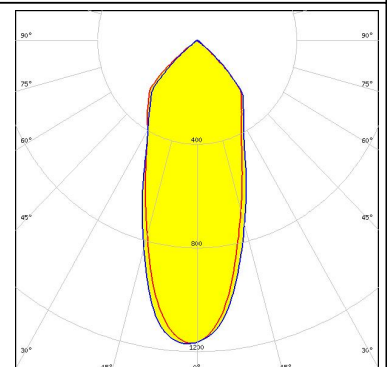
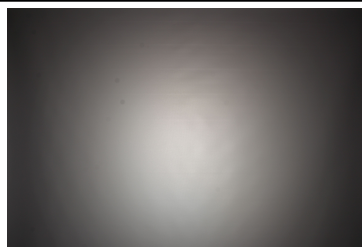

PHOTOMETRIC DATA (MEASURED):



LED CDM-9 (Dim-To-Warm)
 FWHM 30.0°
 Efficiency 91 %
 Peak intensity 1.500 cd/lm
 Required components:
 C13658_CLAMP-VERO13-18
 Bender Wirth: 490 Typ L1

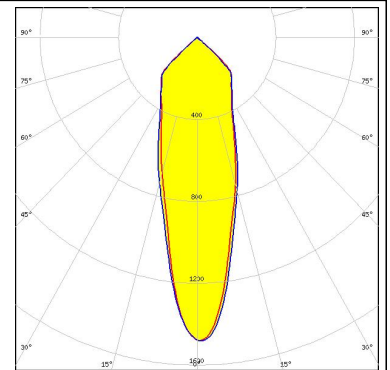
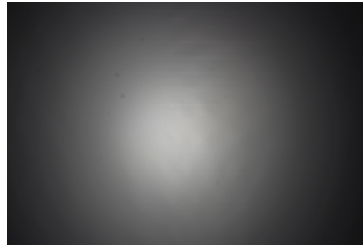

LED CDM-9 (Dim-To-Warm)
 FWHM 36.0°
 Efficiency 87 %
 Peak intensity 1.200 cd/lm
 Required components:
 C13658_CLAMP-VERO13-18
 F13671_ANGE-RZ-LENS
 Bender Wirth: 490 Typ L1

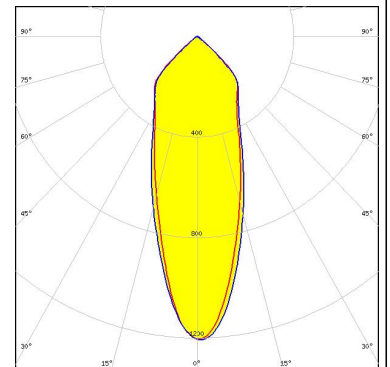
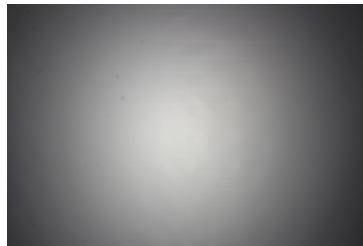

LED CTM-14 (Tunable White)
 FWHM 35.0°
 Efficiency 91 %
 Peak intensity 1.300 cd/lm
 Required components:
 C13584_CLAMP-VERO29
 Bender Wirth: 442 Typ L3

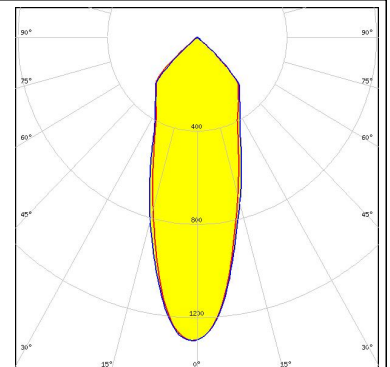
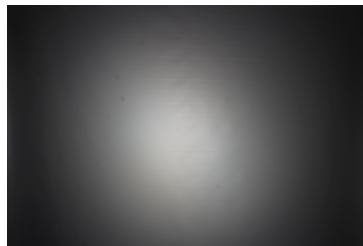

LED CTM-14 (Tunable White)
 FWHM 39.0°
 Efficiency 86 %
 Peak intensity 1.100 cd/lm
 Required components:
 C13584_CLAMP-VERO29
 F13671_ANGE-RZ-LENS
 Bender Wirth: 442 Typ L3

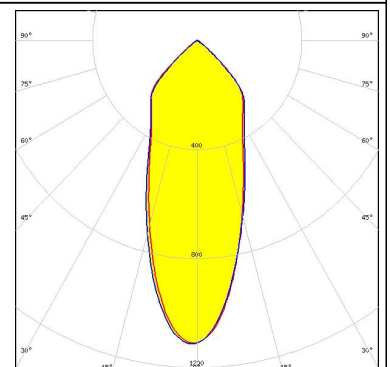
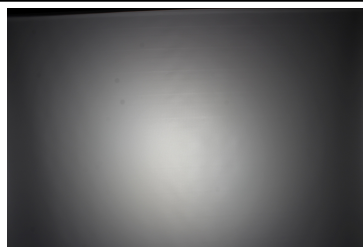

PHOTOMETRIC DATA (MEASURED):



LED CTM-22 (Tunable White)
 FWHM 44.0°
 Efficiency 90 %
 Peak intensity 1.100 cd/lm
 Required components:
 C13584_CLAMP-VERO29
 Bender Wirth: 494 Typ L3

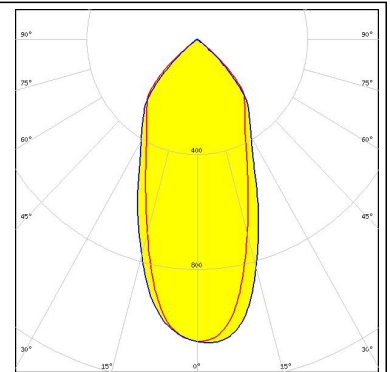
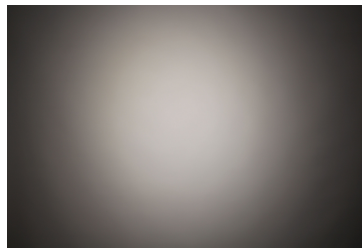

LED CTM-22 (Tunable White)
 FWHM 47.0°
 Efficiency 86 %
 Peak intensity 0.940 cd/lm
 Required components:
 C13584_CLAMP-VERO29
 F13671_ANGE-RZ-LENS
 Bender Wirth: 494 Typ L3

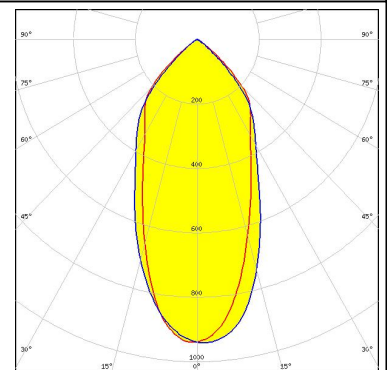
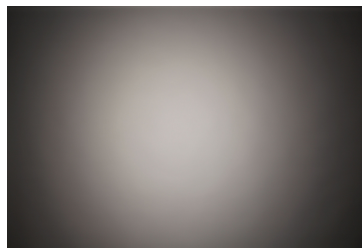

LED CXM-14
 FWHM 34.0°
 Efficiency 93 %
 Peak intensity 1.380 cd/lm
 Required components:
 TE: 2213254-2 + OPTIC CLIP Z50 TYPE1 2213194-1

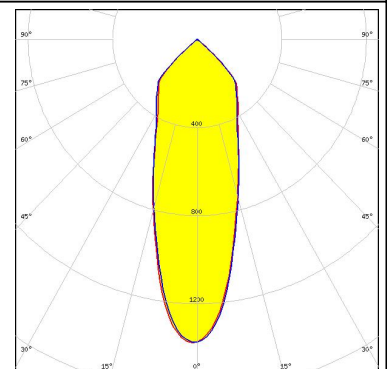
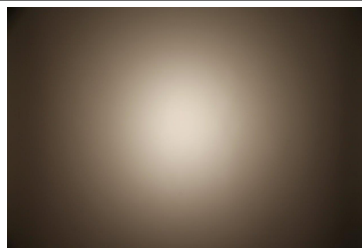

LED COB J-Type
 FWHM 36.0°
 Efficiency 87 %
 Peak intensity 1.200 cd/lm
 Required components:
 F13671_ANGE-RZ-LENS
 IDEAL: 50-2103NC + 50-2100AN

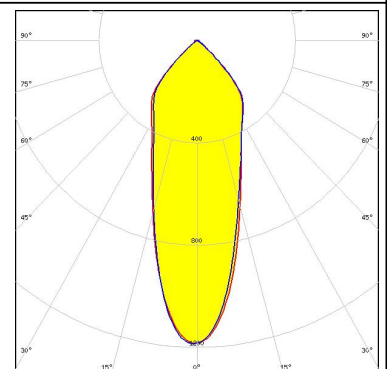
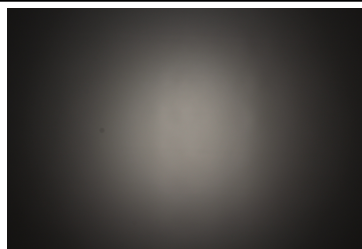

PHOTOMETRIC DATA (MEASURED):



LED COB J-Type
 FWHM 38.0°
 Efficiency 92 %
 Peak intensity 1.200 cd/lm
 Required components:
 C13658_CLAMP-VERO13-18
 Bender Wirth: 463 Typ L2

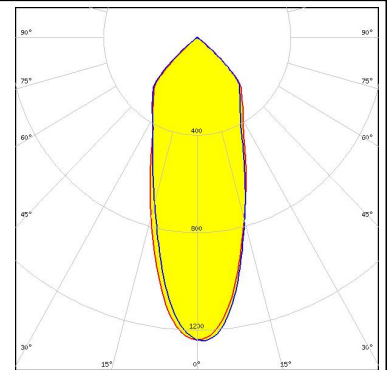
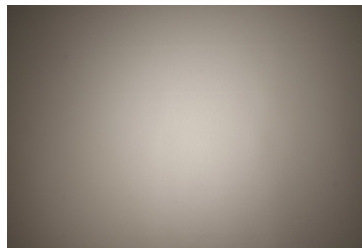

LED COB J-Type
 FWHM 31.0°
 Efficiency 94 %
 Peak intensity 1.520 cd/lm
 Required components:
 IDEAL: 50-2103NC + 50-2100AN

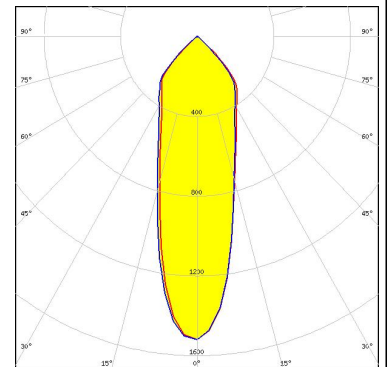
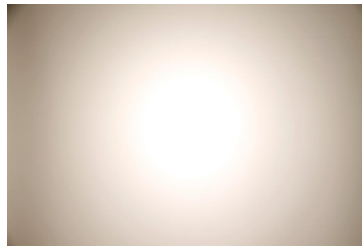

LED COB L-Type (LES 11)
 FWHM 27.0°
 Efficiency 91 %
 Peak intensity 1.640 cd/lm
 Required components:
 IDEAL: 50-2100NC + 50-2100AN

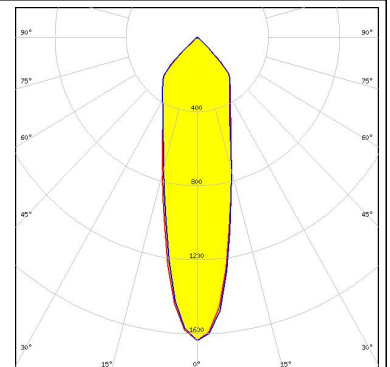
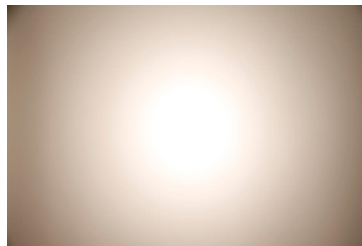

LED COB L-Type (LES 11)
 FWHM 31.0°
 Efficiency 91 %
 Peak intensity 1.440 cd/lm
 Required components:
 TE: 2213382-2 + OPTIC CLIP Z50 TYPE1 2213194-1

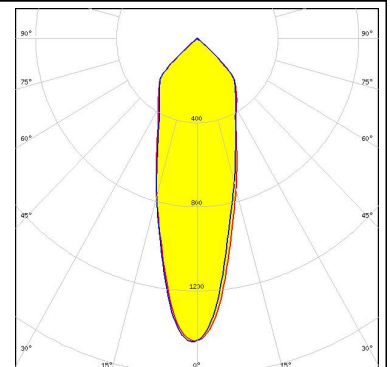
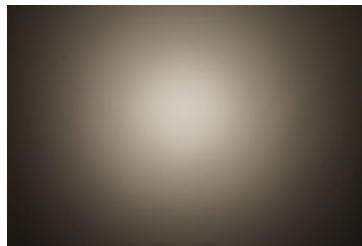

PHOTOMETRIC DATA (MEASURED):



LED COB L-Type (LES 11)
 FWHM 32.0°
 Efficiency 92 %
 Peak intensity 1.400 cd/lm
 Required components:
 C13658_CLAMP-VERO13-18
 Bender Wirth: 438 Typ L1

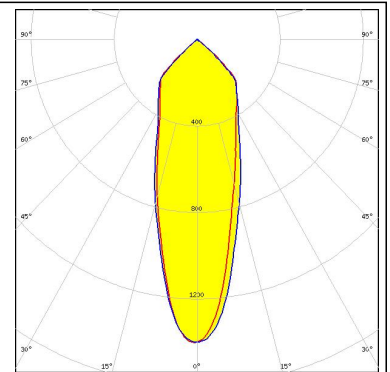
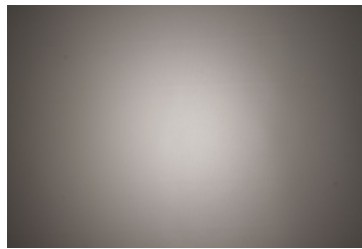

LED COB L-Type (LES 11)
 FWHM 37.0°
 Efficiency 94 %
 Peak intensity 1.270 cd/lm
 Required components:
 Molex: 180580-0005

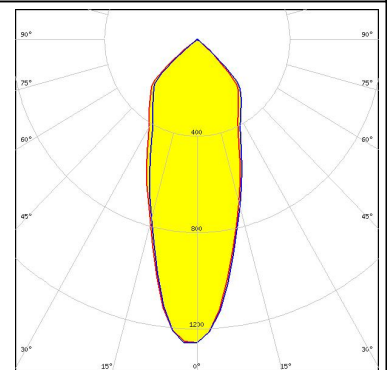
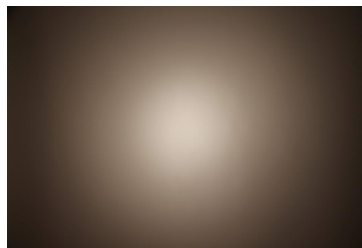

LED PrevaLED Core AC (LEP-2000)
 FWHM 36.0°
 Efficiency 93 %
 Peak intensity 1.310 cd/lm
 Required components:
 TE: OPTIC CLIP Z50 TYPE1 2213194-1

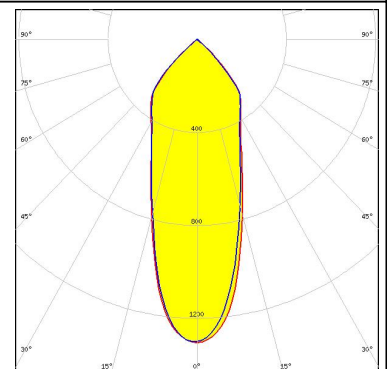
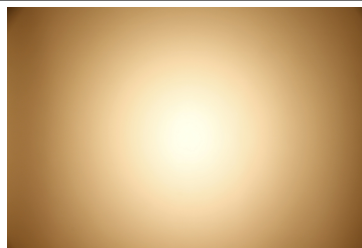

LED PrevaLED Core AC (LEP-800)
 FWHM 28.0°
 Efficiency 93 %
 Peak intensity 1.630 cd/lm
 Required components:
 TE: OPTIC CLIP Z50 TYPE1 2213194-1

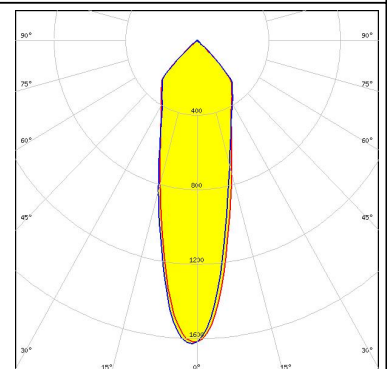
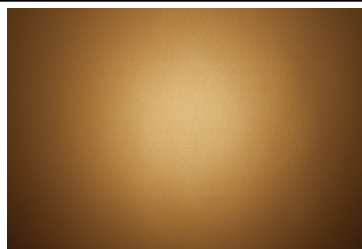

PHOTOMETRIC DATA (MEASURED):

OSRAM

LED PrevaLED Core Z3 LES19
FWHM 37.0°
Efficiency 93 %
Peak intensity 1.300 cd/lm
Required components:
TE: OPTIC CLIP Z50 TYPE1 2213194-1

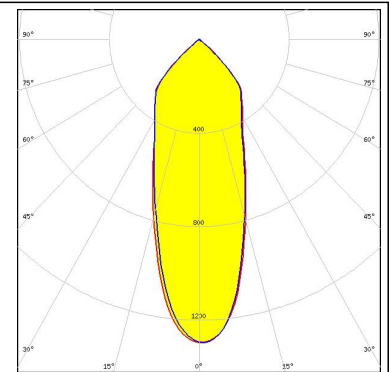
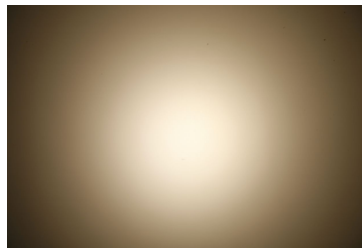

OSRAM

LED PrevaLED Core Z3 LES23
FWHM 43.0°
Efficiency 94 %
Peak intensity 1.160 cd/lm
Required components:
TE: OPTIC CLIP Z50 TYPE1 2213194-1

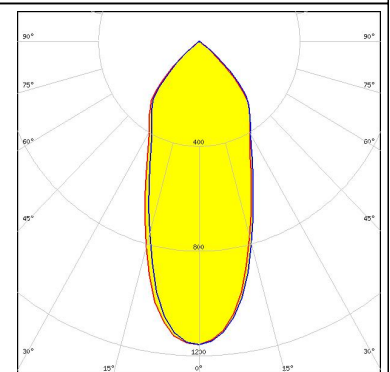
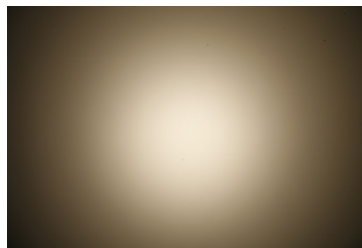

OSRAM

LED PrevaLED Core Z3 LES9
FWHM 26.0°
Efficiency 93 %
Peak intensity 1.730 cd/lm
Required components:
TE: OPTIC CLIP Z50 TYPE1 2213194-1

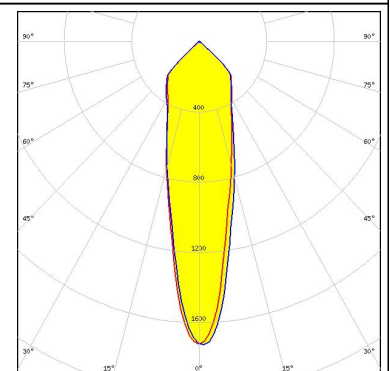
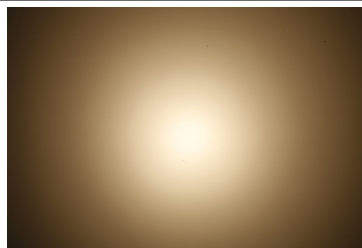

OSRAM

LED PrevaLED Core Z4 LES19
FWHM 34.0°
Efficiency 93 %
Peak intensity 1.400 cd/lm
Required components:
TE: OPTIC CLIP Z50 TYPE1 2213194-1

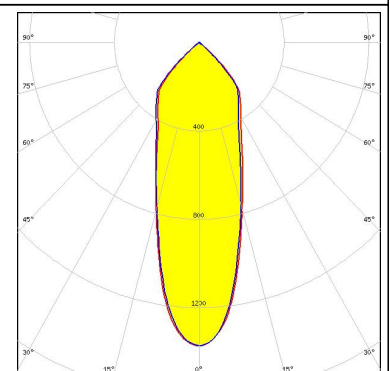
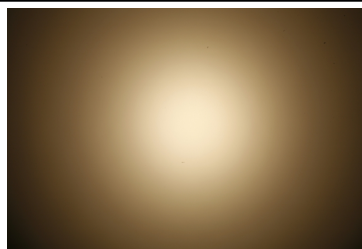

PHOTOMETRIC DATA (MEASURED):

OSRAM

LED PrevaLED Core Z4 LES19
 FWHM 40.0°
 Efficiency 88 %
 Peak intensity 1.100 cd/lm
 Required components:
 F13671_ANGE-RZ-LENS
 TE: OPTIC CLIP Z50 TYPE1 2213194-1

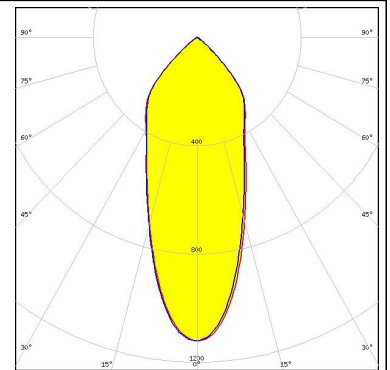
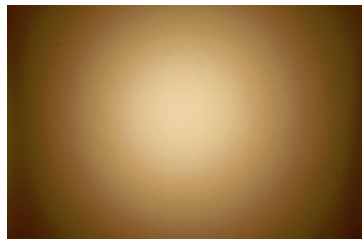

OSRAM Opto Semiconductors

LED Soleriq S13
 FWHM 34.0°
 Efficiency 94 %
 Peak intensity 1.500 cd/lm
 Required components:
 TE: 2213401-2 + OPTIC CLIP Z50 TYPE1 2213194-1

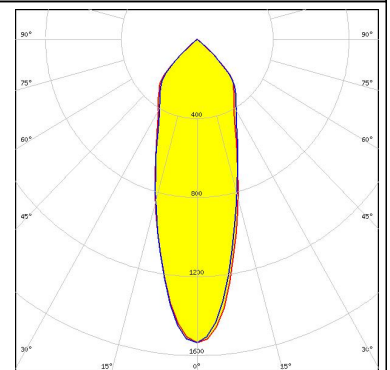
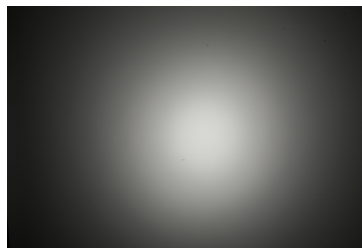

OSRAM Opto Semiconductors

LED Soleriq S13
 FWHM 34.0°
 Efficiency 92 %
 Peak intensity 1.300 cd/lm
 Required components:
 C13658_CLAMP-VERO13-18
 Bender Wirth: 437 Typ L1

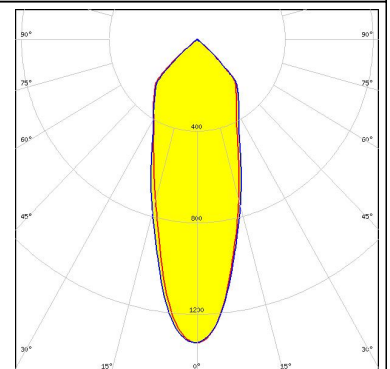
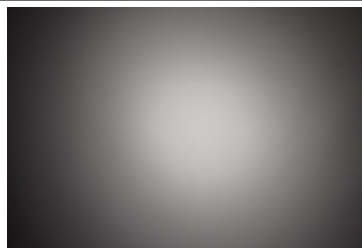

OSRAM Opto Semiconductors

LED Soleriq S13 Gen2
 FWHM 34.0°
 Efficiency 93 %
 Peak intensity 1.400 cd/lm
 Required components:
 TE: 2213382-2 + OPTIC CLIP Z50 TYPE1 2213194-1

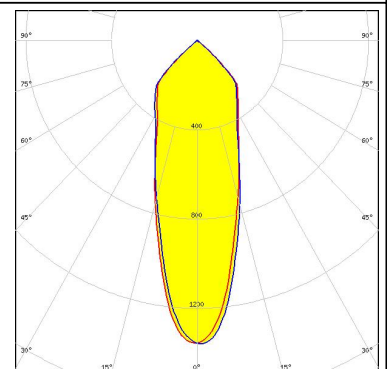
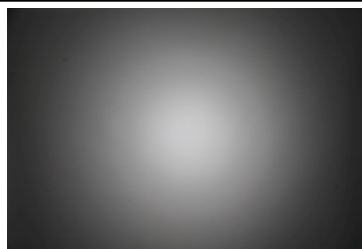

PHOTOMETRIC DATA (MEASURED):

OSRAM
Opto Semiconductors

LED Soleriq S13 Gen2

FWHM 30.0°

Efficiency 91 %

Peak intensity 1.500 cd/lm

Required components:

IDEAL: 50-2103CT + 50-2100AN

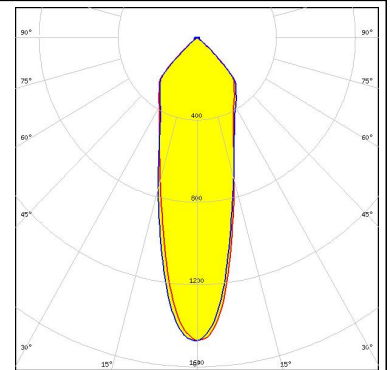
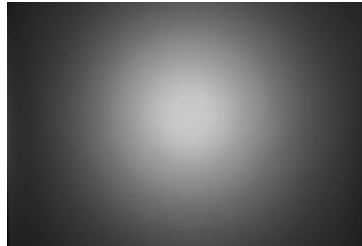

OSRAM
Opto Semiconductors

LED Soleriq S19

FWHM 37.0°

Efficiency 93 %

Peak intensity 1.310 cd/lm

Required components:

TE: 2213407-2 + OPTIC CLIP Z50 TYPE1 2213194-1

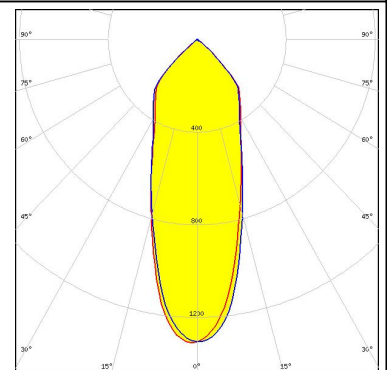
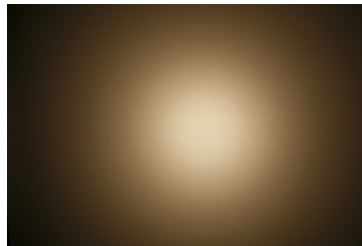

OSRAM
Opto Semiconductors

LED Soleriq S19

FWHM 35.0°

Efficiency 91 %

Peak intensity 1.300 cd/lm

Required components:

C13584_CLAMP-VERO29

Bender Wirth: 462 Typ L3

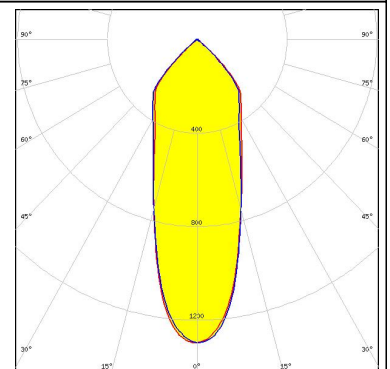
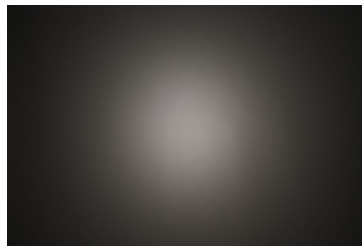

PHILIPS

LED Fortimo SLM L09 Standard

FWHM 27.0°

Efficiency 92 %

Peak intensity 1.600 cd/lm

Required components:

TE: OPTIC CLIP Z50 TYPE1 2213194-1

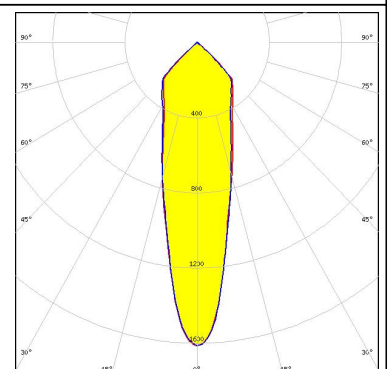

PHOTOMETRIC DATA (MEASURED):

PHILIPS

LED Fortimo SLM L09 Standard
FWHM 27.0°
Efficiency 92 %
Peak intensity 1.600 cd/lm
Required components:
TE: OPTIC CLIP Z50 TYPE1 2213194-1

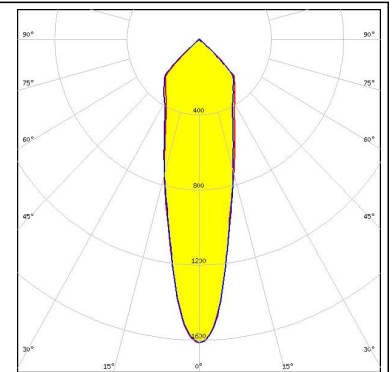
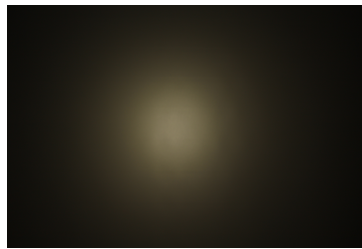

PHILIPS

LED Fortimo SLM L13 Standard
FWHM 32.0°
Efficiency 91 %
Peak intensity 1.450 cd/lm
Required components:
TE: OPTIC CLIP Z50 TYPE1 2213194-1

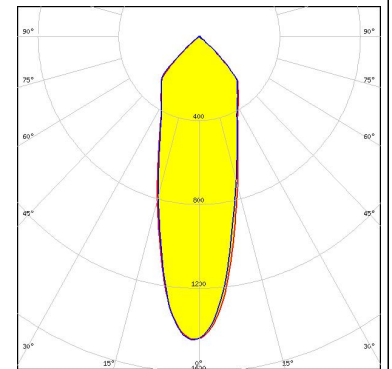
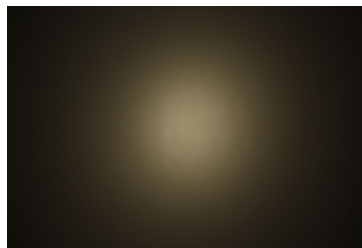

PHILIPS

LED Fortimo SLM L15 Standard
FWHM 41.0°
Efficiency 86 %
Peak intensity 1.000 cd/lm
Required components:
F13671_ANGE-RZ-LENS
TE: OPTIC CLIP Z50 TYPE1 2213194-1

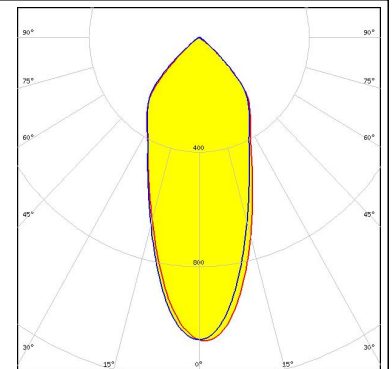
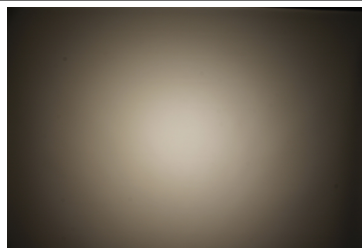

PHILIPS

LED Fortimo SLM L15 Standard
FWHM 35.0°
Efficiency 90 %
Peak intensity 1.300 cd/lm
Required components:
TE: OPTIC CLIP Z50 TYPE1 2213194-1

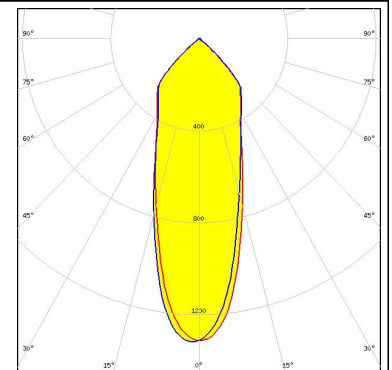
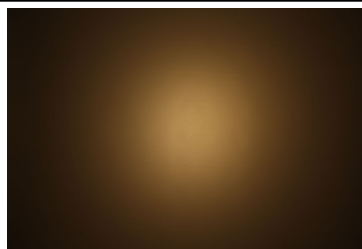

PHOTOMETRIC DATA (MEASURED):

PHILIPS

LED Fortimo SLM L19 Standard
 FWHM 40.0°
 Efficiency 89 %
 Peak intensity 1.160 cd/lm
 Required components:
 TE: OPTIC CLIP Z50 TYPE1 2213194-1

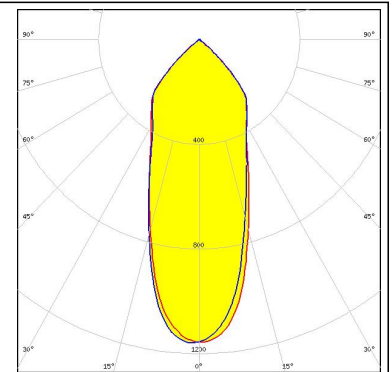
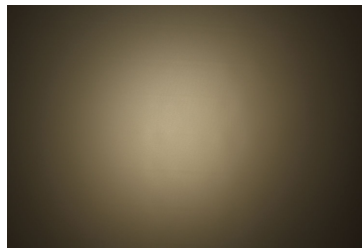

SAMSUNG

LED LC026B / 033B / 040B
 FWHM 39.0°
 Efficiency 93 %
 Peak intensity 1.200 cd/lm
 Required components:
 TE: 2213258-2 + OPTIC CLIP Z50 TYPE1 2213194-1

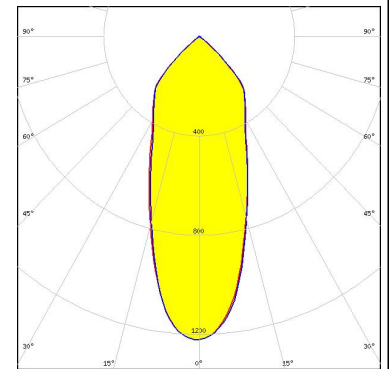
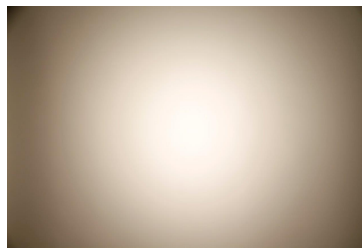

SAMSUNG

LED LC026B / 033B / 040B
 FWHM 41.0°
 Efficiency 92 %
 Peak intensity 1.100 cd/lm
 Required components:
 C13658_CLAMP-VERO13-18
 Bender Wirth: 450 Typ L2

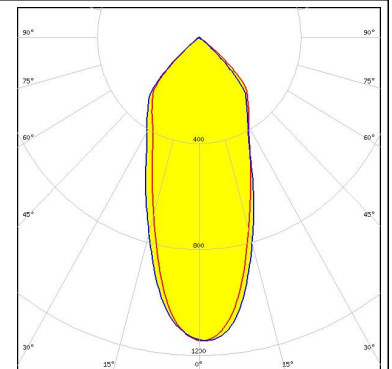
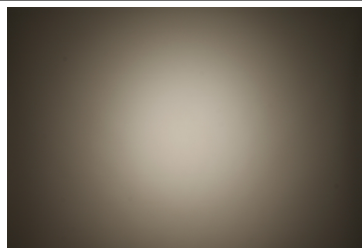

SAMSUNG

LED LC040C
 FWHM 32.0°
 Efficiency 91 %
 Peak intensity 1.400 cd/lm
 Required components:
 TE: 2213382-2 + OPTIC CLIP Z50 TYPE1 2213194-1

