



Chipsmall Limited consists of a professional team with an average of over 10 year of expertise in the distribution of electronic components. Based in Hongkong, we have already established firm and mutual-benefit business relationships with customers from,Europe,America and south Asia,supplying obsolete and hard-to-find components to meet their specific needs.

With the principle of “Quality Parts,Customers Priority,Honest Operation,and Considerate Service”,our business mainly focus on the distribution of electronic components. Line cards we deal with include Microchip,ALPS,ROHM,Xilinx,Pulse,ON,Everlight and Freescale. Main products comprise IC,Modules,Potentiometer,IC Socket,Relay,Connector.Our parts cover such applications as commercial,industrial, and automotives areas.

We are looking forward to setting up business relationship with you and hope to provide you with the best service and solution. Let us make a better world for our industry!



Contact us

Tel: +86-755-8981 8866 Fax: +86-755-8427 6832

Email & Skype: info@chipsmall.com Web: www.chipsmall.com

Address: A1208, Overseas Decoration Building, #122 Zhenhua RD., Futian, Shenzhen, China



BARBARA-S-PF

~15° spot beam

TECHNICAL SPECIFICATIONS:

Dimensions	Ø 70 mm
Height	41.7 mm
Fastening	socket
Colour	metal
Box size	480 x 280 x 300 mm
Box weight	6.1 kg
Quantity in Box	288 pcs
ROHS compliant	yes ⓘ





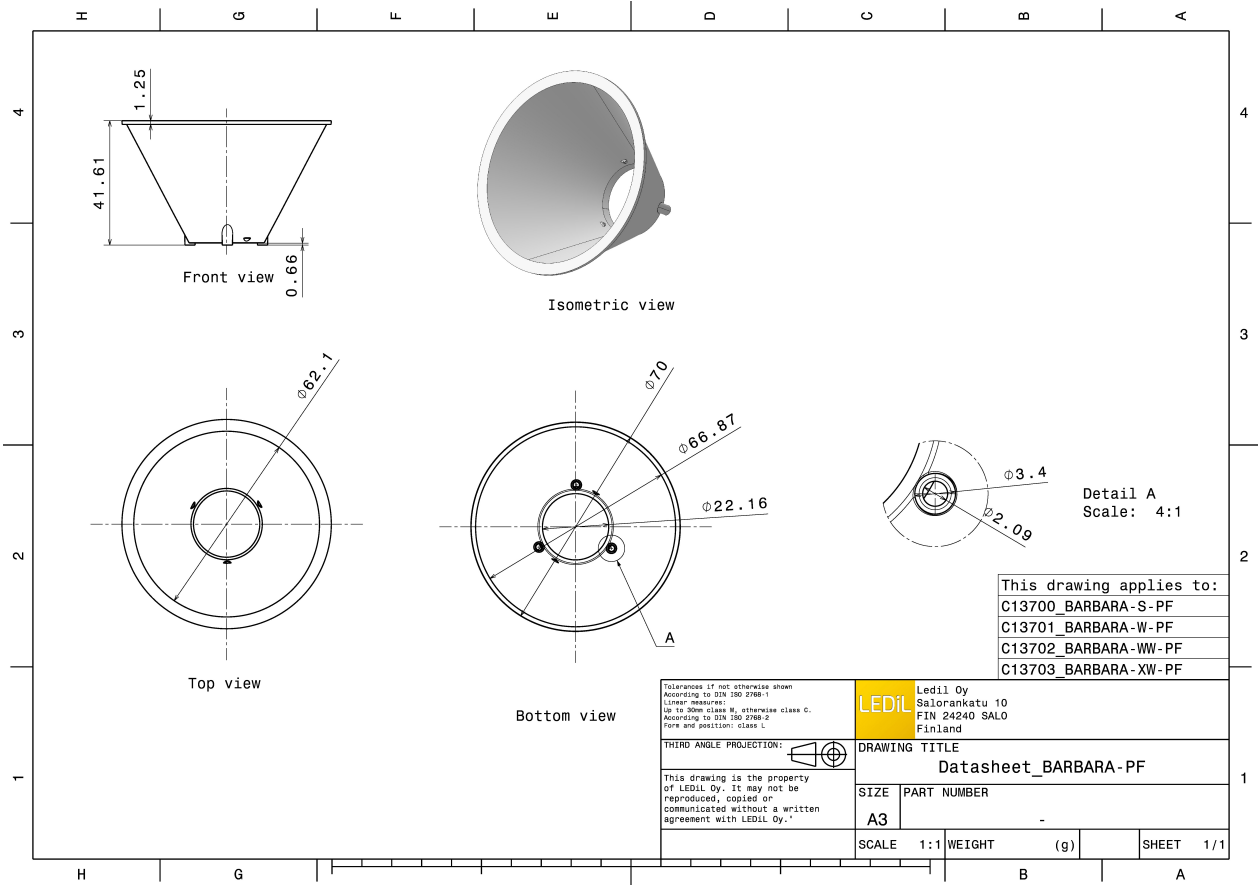

MATERIAL SPECIFICATIONS:



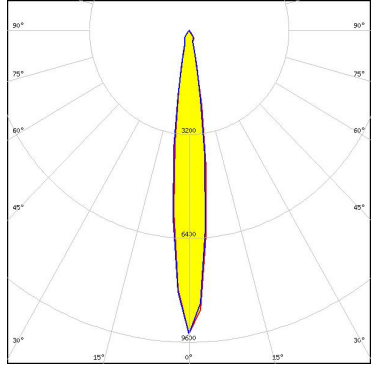

Component	Type	Material	Colour	Coating
BARBARA-S-PF	Reflector	PC	metal	HMDS

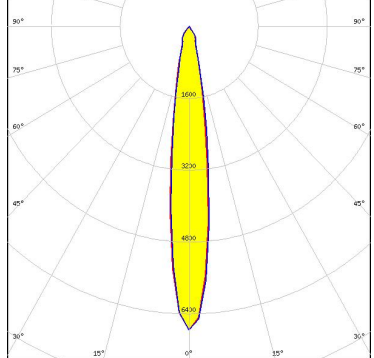

PHOTOMETRIC DATA (MEASURED):

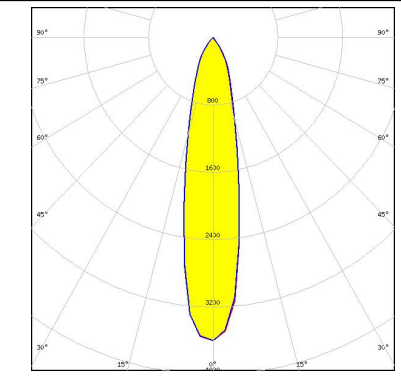
<p>bridgelux.</p> <p>LED V15 Gen6 FWHM 18.0° Efficiency 92 % Peak intensity 4.750 cd/lm Required components: C13709_PF-SOCKET-VERO13-18 Bender Wirth: 456 Typ L2</p>		
<p>bridgelux.</p> <p>LED V8 Gen6 FWHM 13.0° Efficiency 86 % Peak intensity 10.600 cd/lm Required components: C13709_PF-SOCKET-VERO13-18 Bender Wirth: 460 Typ L1</p>		
<p>bridgelux.</p> <p>LED VERO10 FWHM 13.0° Efficiency 90 % Peak intensity 9.300 cd/lm Required components: C13708_PF-SOCKET-VERO10</p>		
<p>bridgelux.</p> <p>LED VERO13 FWHM 15.0° Efficiency 91 % Peak intensity 6.800 cd/lm Required components: C13709_PF-SOCKET-VERO13-18</p>		

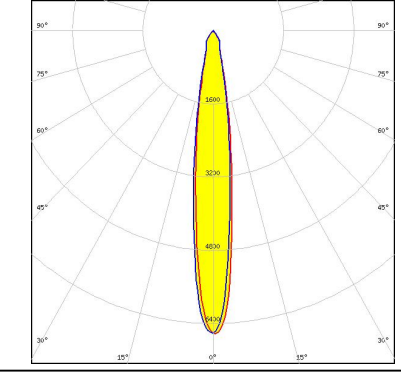
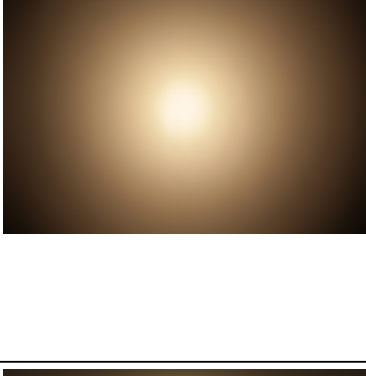
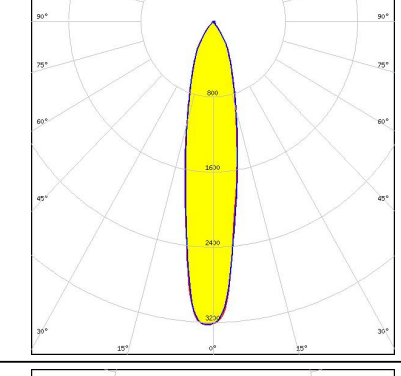
PHOTOMETRIC DATA (MEASURED):

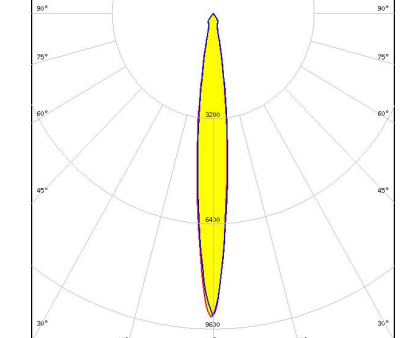
<p>bridgelux.</p> <p>LED VERO18</p> <p>FWHM 22.0°</p> <p>Efficiency 91 %</p> <p>Peak intensity 3.600 cd/lm</p> <p>Required components: C13709_PF-SOCKET-VERO13-18</p>		
<p>bridgelux.</p> <p>LED Xenio Point 13mm</p> <p>FWHM 14.0°</p> <p>Efficiency 91 %</p> <p>Peak intensity 6.640 cd/lm</p> <p>Required components: C13709_PF-SOCKET-VERO13-18</p>		
<p>bridgelux.</p> <p>LED Xenio Point 18mm</p> <p>FWHM 21.0°</p> <p>Efficiency 86 %</p> <p>Peak intensity 3.230 cd/lm</p> <p>Required components: C13709_PF-SOCKET-VERO13-18</p>		
<p>CITIZEN</p> <p>LED CLL02x/CLU02x (LES10)</p> <p>FWHM 12.0°</p> <p>Efficiency 89 %</p> <p>Peak intensity 9.200 cd/lm</p> <p>Required components: C13709_PF-SOCKET-VERO13-18 Bender Wirth: 434 Typ L1</p>		

PHOTOMETRIC DATA (MEASURED):

CITIZEN

LED CLL03x/CLU03x
 FWHM 16.0°
 Efficiency 88 %
 Peak intensity 5.100 cd/lm
 Required components:
 C13709_PF-SOCKET-VERO13-18
 Bender Wirth: 433 Typ L1

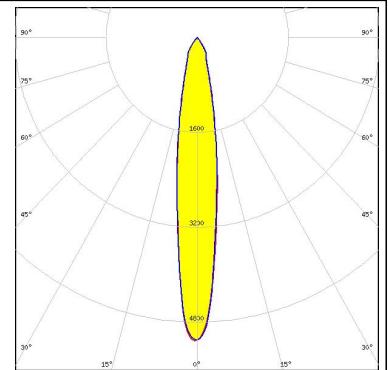
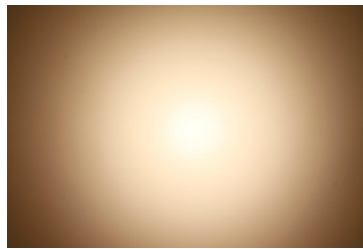

CITIZEN

LED CLU720/721
 FWHM 14.0°
 Efficiency 87 %
 Peak intensity 7.300 cd/lm
 Required components:
 C13709_PF-SOCKET-VERO13-18
 Bender Wirth: 433 Typ L1

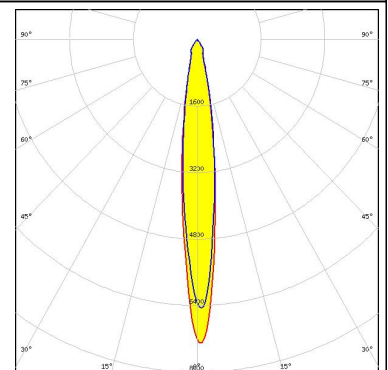
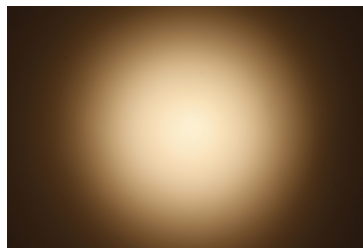

CREE

LED CXA/B 15xx
 FWHM 15.0°
 Efficiency 89 %
 Peak intensity 6.900 cd/lm
 Required components:
 C13709_PF-SOCKET-VERO13-18
 Bender Wirth: 441 Typ L1

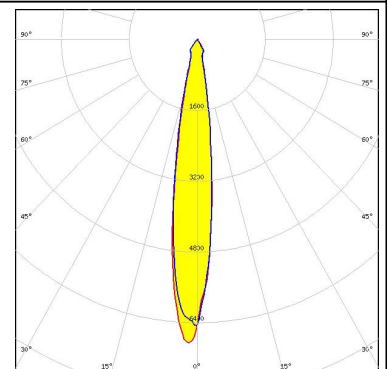
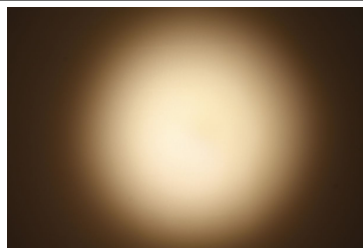

CREE

LED CXA/B 15xx
 FWHM 13.0°
 Efficiency 85 %
 Peak intensity 7.400 cd/lm
 Required components:
 C13083_PF-SOCKET
 C14658_BARBARA-RZ-LENS

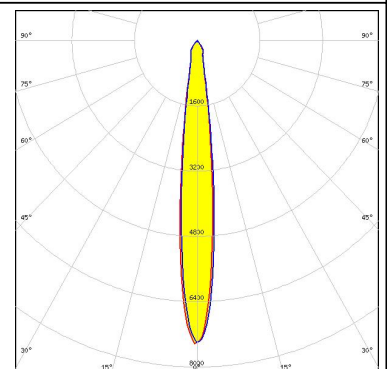
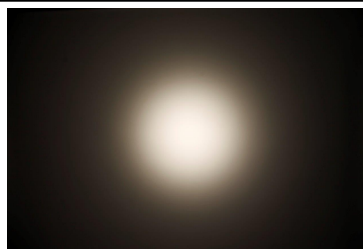

PHOTOMETRIC DATA (MEASURED):



LED CXA/B 15xx
 FWHM 14.0°
 Efficiency 91 %
 Peak intensity 8.600 cd/lm
 Required components:
 C14115_PF-SOCKET-CXA15-18

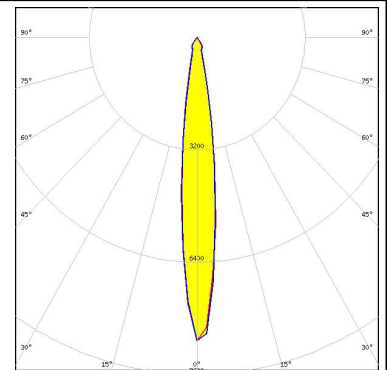
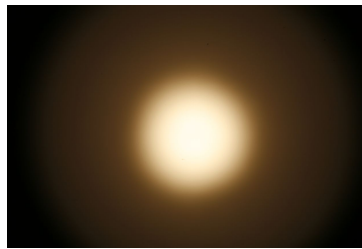

LED CXA/B 1816 & CXA/B 1820 & CXA 1850
 FWHM 15.0°
 Efficiency 92 %
 Peak intensity 6.800 cd/lm
 Required components:
 C14115_PF-SOCKET-CXA15-18

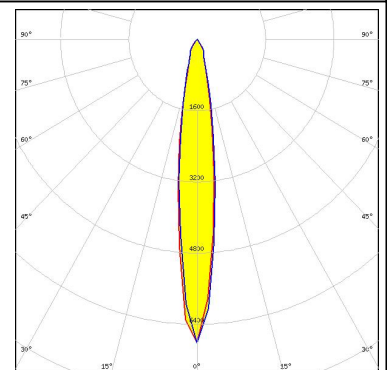

LED CXA/B 1816 & CXA/B 1820 & CXA 1850
 FWHM 14.0°
 Efficiency 86 %
 Peak intensity 6.100 cd/lm
 Required components:
 C13709_PF-SOCKET-VERO13-18
 Bender Wirth: 437 Typ L1

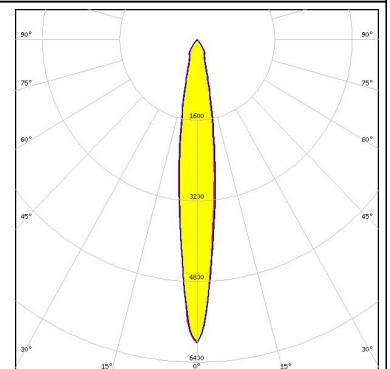
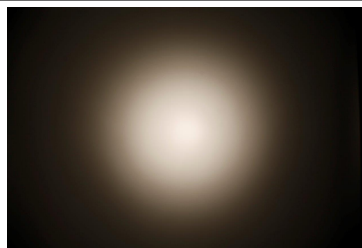

LED LUXEON CoB 1202/1203
 FWHM 14.0°
 Efficiency 88 %
 Peak intensity 7.300 cd/lm
 Required components:
 C13709_PF-SOCKET-VERO13-18
 Bender Wirth: 438 Typ L1

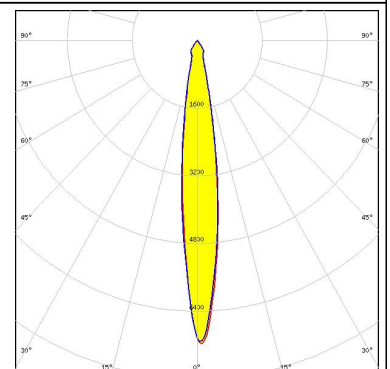

PHOTOMETRIC DATA (MEASURED):



LED LUXEON CoB 1202/1203
 FWHM 12.0°
 Efficiency 90 %
 Peak intensity 10.600 cd/lm
 Required components:
 C14037_PF-NSX-SOCKET

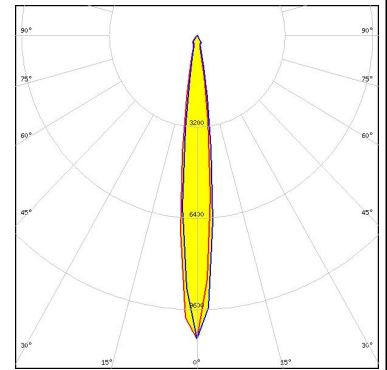

LED LUXEON CoB 1202s
 FWHM 9.0°
 Efficiency 90 %
 Peak intensity 19.600 cd/lm
 Required components:
 C13761_PF-SOCKET-CXA15



LED COB J-Type
 FWHM 19.0°
 Efficiency 91 %
 Peak intensity 4.730 cd/lm
 Required components:
 C14037_PF-NSX-SOCKET

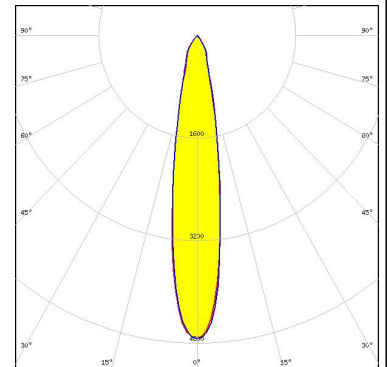

LED COB J-Type
 FWHM 17.0°
 Efficiency 88 %
 Peak intensity 4.600 cd/lm
 Required components:
 C13709_PF-SOCKET-VERO13-18
 Bender Wirth: 463 Typ L2

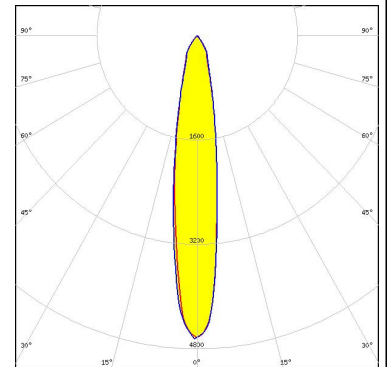
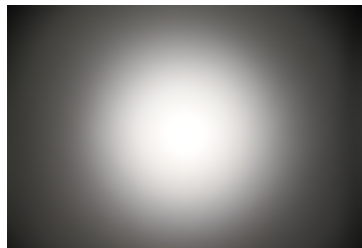

PHOTOMETRIC DATA (MEASURED):



LED COB L-Type (LES 11)
 FWHM 15.0°
 Efficiency 90 %
 Peak intensity 6.800 cd/lm
 Required components:
 C14037_PF-NSX-SOCKET

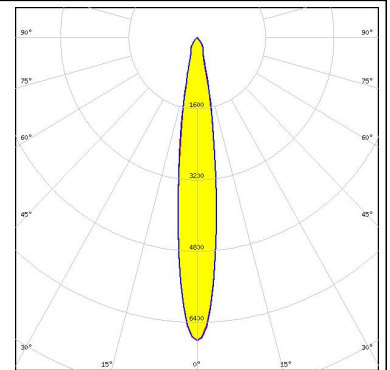
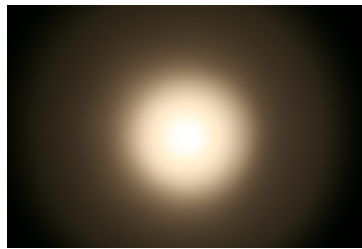

LED COB L-Type (LES 11)
 FWHM 14.0°
 Efficiency 86 %
 Peak intensity 6.100 cd/lm
 Required components:
 C13709_PF-SOCKET-VERO13-18
 Bender Wirth: 438 Typ L1

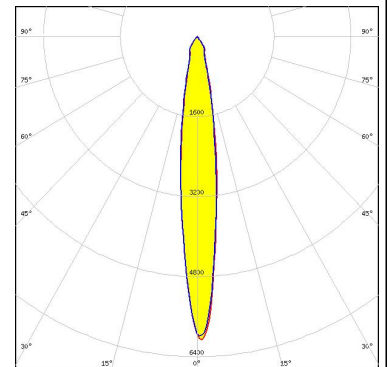

LED COB L-Type (LES 9)
 FWHM 13.0°
 Efficiency 90 %
 Peak intensity 10.100 cd/lm
 Required components:
 C14037_PF-NSX-SOCKET

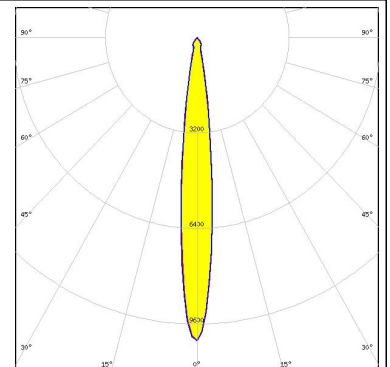
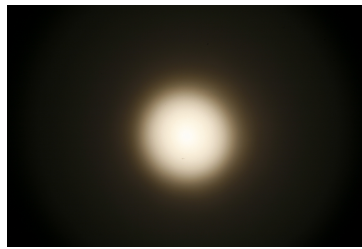

LED COB L-Type (LES 9)
 FWHM 13.0°
 Efficiency 90 %
 Peak intensity 8.400 cd/lm
 Required components:
 C13709_PF-SOCKET-VERO13-18
 Bender Wirth: 438 Typ L1

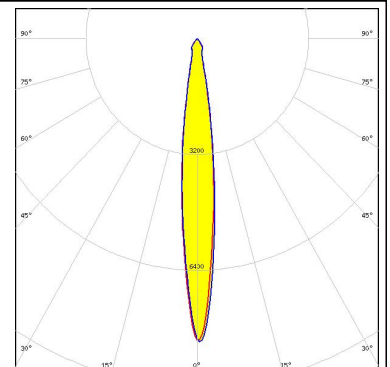

PHOTOMETRIC DATA (MEASURED):



LED NSCxL036A
 FWHM 11.0°
 Efficiency 89 %
 Peak intensity 14.120 cd/lm
 Required components:
 C14037_PF-NSX-SOCKET

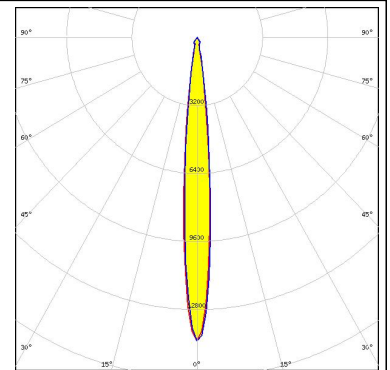
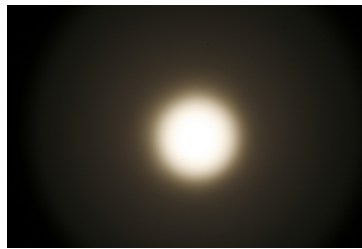

LED Soleriq P13
 FWHM 16.0°
 Efficiency 91 %
 Peak intensity 5.400 cd/lm
 Required components:
 C13709_PF-SOCKET-VERO13-18
 Bender Wirth: 437 Typ L1

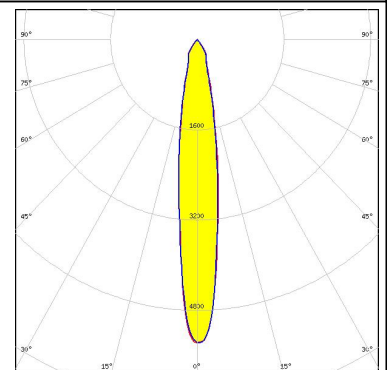
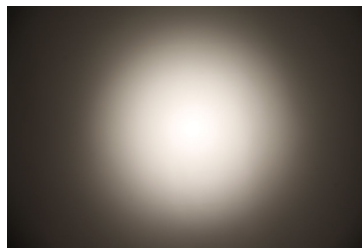

LED Soleriq P13
 FWHM 15.0°
 Efficiency 89 %
 Peak intensity 5.380 cd/lm
 Required components:
 C14115_PF-SOCKET-CXA15-18

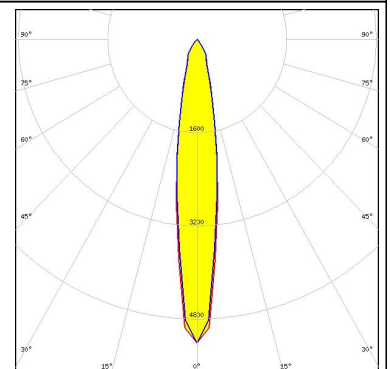
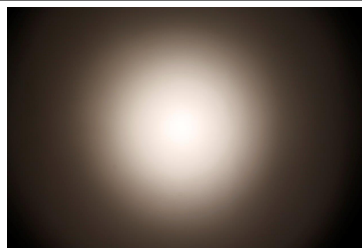

LED Soleriq P6
 FWHM 12.0°
 Efficiency 89 %
 Peak intensity 12.000 cd/lm
 Required components:
 C13709_PF-SOCKET-VERO13-18
 Bender Wirth: 446 Typ L1

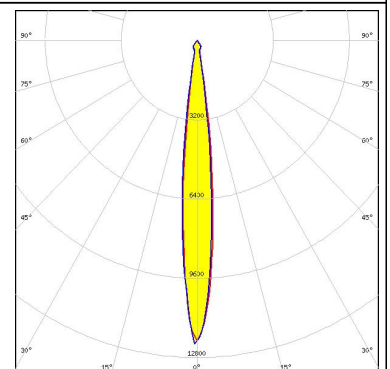
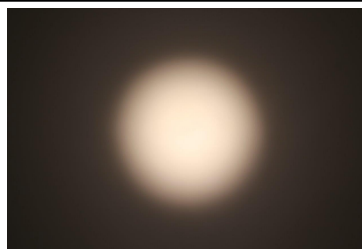

PHOTOMETRIC DATA (MEASURED):

OSRAM
Opto Semiconductors

LED Soleriq P6
FWHM 10.0°
Efficiency 90 %
Peak intensity 16.700 cd/lm
Required components:
C13761_PF-SOCKET-CXA15

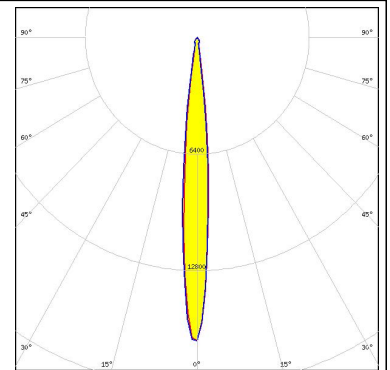

OSRAM
Opto Semiconductors

LED Soleriq P9
FWHM 12.0°
Efficiency 91 %
Peak intensity 11.800 cd/lm
Required components:
C13761_PF-SOCKET-CXA15

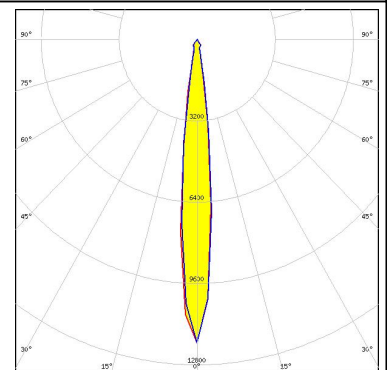
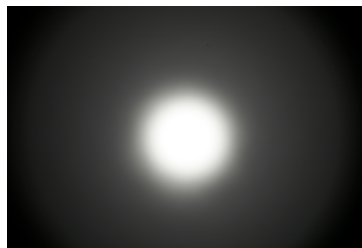

OSRAM
Opto Semiconductors

LED Soleriq P9
FWHM 12.0°
Efficiency 92 %
Peak intensity 9.600 cd/lm
Required components:
C13709_PF-SOCKET-VERO13-18
Bender Wirth: 461 Typ L1

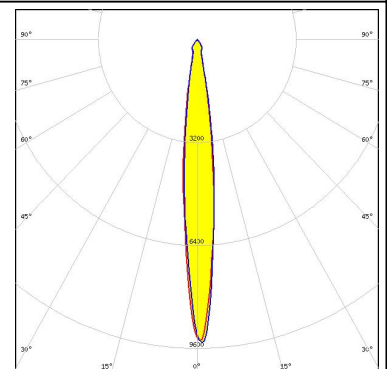

OSRAM
Opto Semiconductors

LED Soleriq S13
FWHM 14.0°
Efficiency 89 %
Peak intensity 6.200 cd/lm
Required components:
C13709_PF-SOCKET-VERO13-18
Bender Wirth: 437 Typ L1

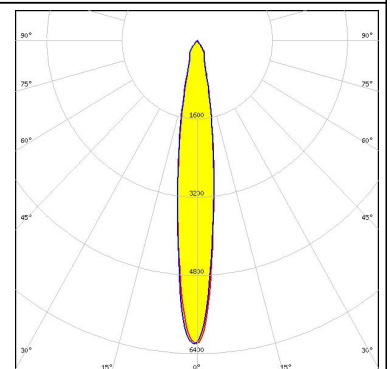
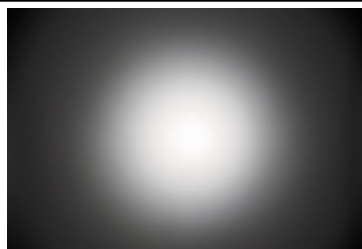

PHOTOMETRIC DATA (MEASURED):

SAMSUNG

LED LC026B / 033B / 040B
FWHM 20.0°
Efficiency 88 %
Peak intensity 3.700 cd/lm
Required components:
C13709_PF-SOCKET-VERO13-18
Bender Wirth: 450 Typ L2

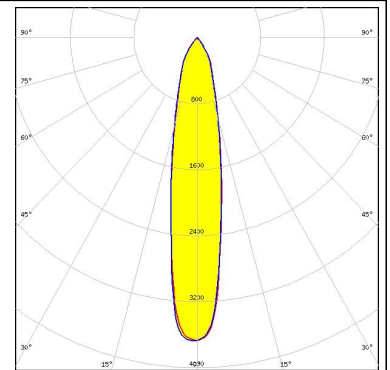

TRIDONIC

LED SLE G5 LES11
FWHM 13.0°
Efficiency 91 %
Peak intensity 8.500 cd/lm
Required components:
C13709_PF-SOCKET-VERO13-18
Bender Wirth: 434 Typ L1

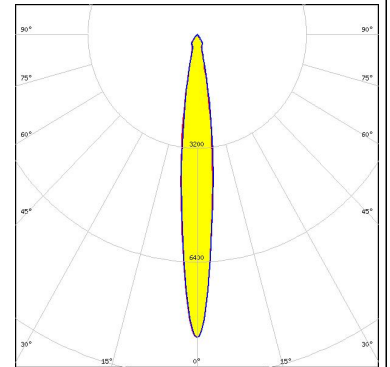

XICATO

LED XTM - 19mm LES
FWHM 20.0°
Efficiency 88 %
Peak intensity 3.600 cd/lm
Required components:
C14636_XTM-PF-ADAPTER

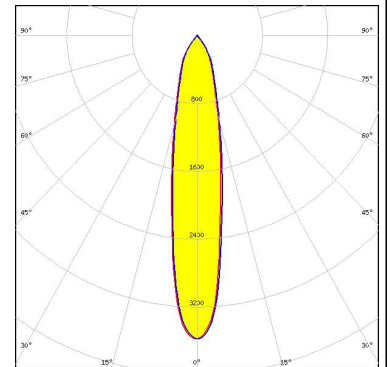

XICATO

LED XTM - 9mm LES
FWHM 12.0°
Efficiency 90 %
Peak intensity 9.300 cd/lm
Required components:
C14636_XTM-PF-ADAPTER

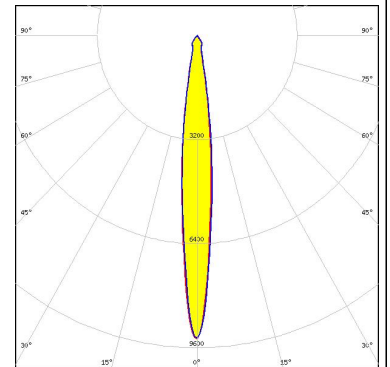

PHOTOMETRIC DATA (SIMULATED):

bridgelux.

LED V10 Gen7
FWHM 12.0°
Efficiency 91 %
Peak intensity 9.440 cd/lm

Required components:

C13709_PF-SOCKET-VERO13-18

Bender Wirth: 434 Typ L1

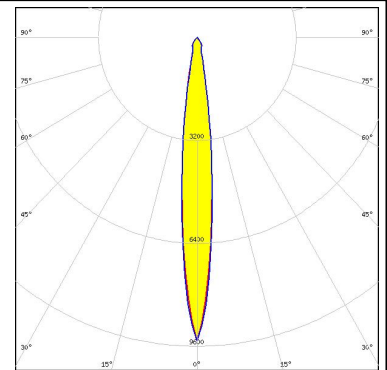

bridgelux.

LED VERO10
FWHM 13.0°
Efficiency 0 %
Peak intensity 0.000 cd/lm

Required components:

bridgelux.

LED VERO13
FWHM 15.0°
Efficiency 0 %
Peak intensity 0.000 cd/lm

Required components:

bridgelux.

LED VERO18
FWHM 21.0°
Efficiency 0 %
Peak intensity 0.000 cd/lm

Required components:

PHOTOMETRIC DATA (SIMULATED):

CREE

LED CXA/B 15xx
FWHM 12.0°
Efficiency 0 %
Peak intensity 0.000 cd/lm
Required components:

LUMILEDS

LED LUXEON CoB Compact
FWHM 9.0°
Efficiency 90 %
Peak intensity 19.600 cd/lm
Required components:
C13761_PF-SOCKET-CXA15

LUMINUS

LED CXM-14
FWHM 16.0°
Efficiency 88 %
Peak intensity 5.130 cd/lm
Required components:
C13709_PF-SOCKET-VERO13-18
Bender Wirth: 433 Typ L1

LUMINUS

LED CXM-9
FWHM 12.0°
Efficiency 89 %
Peak intensity 9.200 cd/lm
Required components:
C13709_PF-SOCKET-VERO13-18
Bender Wirth: 434 Typ L1

PHOTOMETRIC DATA (SIMULATED):

OSRAM
Opto Semiconductors

LED Soleriq S15
FWHM 20.0°
Efficiency 88 %
Peak intensity 4.013 cd/lm

Required components:

C13709_PF-SOCKET-VERO13-18
Bender Wirth: 433 Typ L1

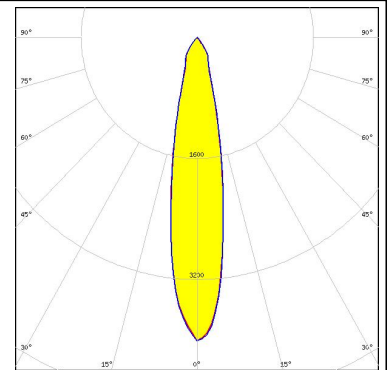

SAMSUNG

LED LC010C
FWHM 9.1°
Efficiency 89 %
Peak intensity 16.300 cd/lm

Required components:

C13709_PF-SOCKET-VERO13-18
Bender Wirth: 479 Typ L1

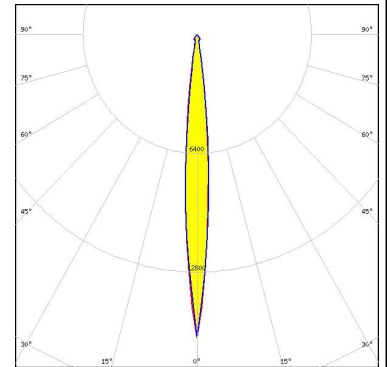

SAMSUNG

LED LC020C
FWHM 10.0°
Efficiency 89 %
Peak intensity 12.300 cd/lm

Required components:

C13709_PF-SOCKET-VERO13-18
Bender Wirth: 479 Typ L1

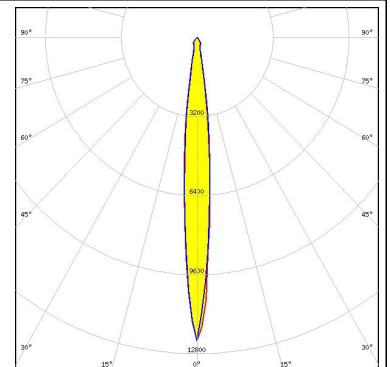

SAMSUNG



LED LC040C
FWHM 13.0°
Efficiency 85 %
Peak intensity 7.300 cd/lm

Required components:

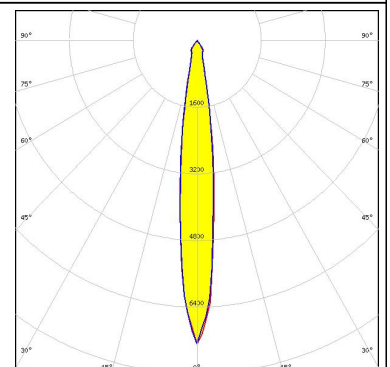
C13709_PF-SOCKET-VERO13-18
Bender Wirth: 480 Typ L1



PHOTOMETRIC DATA (SIMULATED):

 SEOL SEMICONDUCTOR	
LED	ZC12/18
FWHM	16.0°
Efficiency	88 %
Peak intensity	5.100 cd/lm
Required components:	
C13709_PF-SOCKET-VERO13-18	
Bender Wirth: 433 Typ L1	
<hr/>	
 SEOL SEMICONDUCTOR	
LED	ZC4/6
FWHM	12.0°
Efficiency	89 %
Peak intensity	9.200 cd/lm
Required components:	
C13709_PF-SOCKET-VERO13-18	
Bender Wirth: 434 Typ L1	

GENERAL INFORMATION:

NOTE: The typical beam angle will be changed by different color, chip size and chip position tolerance. The typical total beam angle is the full angle measured where the luminous intensity is half of the peak value.

Due to use of high power COB's with this product, special attention to proper thermal design is highly recommended. LEDiL has no liability for direct, indirect or consecutive damages arising from the LEDiL products being used outside of the recommended temperature range.

MATERIALS:

As part of our continuous research and improvement processes, and to ensure the best possible quality and availability of our products, LEDiL reserves the right to change material grades without notice.

PRODUCT DATA USER AGREEMENT AND DISCLAIMER:

The measured data in the provided downloadable LEDiL Product Datasheets and Mechanical 2D-Drawings is rounded and provided as reference for planning. LEDiL Oy's optical specifications have been verified by conducting performance testing of the products in accordance with the company's quality system. The reported data are averaged results of multiple measurements with typical variation. LEDiL Oy reserves the right to without prior notification make changes and improvements to its products.

LEDiL Oy assumes neither warranty, nor guarantee nor any other liability of any kind for the contents and correctness of the provided data. The provided data has been generated with highest diligence but the provided data may in reality not represent the complete possible variation range of all intrinsic parameters. Therefore, in certain cases a deviation from the provided data could occur.

LEDiL Oy reserves the right to undertake technical changes of its products without further notification which could lead to changes in the provided data. LEDiL Oy assumes no liability of any kind for the possible deviation from any provided data or any other damage resulting from the usage of the provided data.

The user agrees to this disclaimer and user agreement with the download or usage of the provided files.

LEDiL Oy

Joensuunkatu 13
FI-24240 SALO
Finland

LEDiL Inc.

228 West Page Street
Suite D
Sycamore IL 60178
USA

Local sales and technical support

www.ledil.com/where_to_buy

Shipping locations

Salo, Finland
Hong Kong, China

Distribution Partners

www.ledil.com/where_to_buy