



Chipsmall Limited consists of a professional team with an average of over 10 year of expertise in the distribution of electronic components. Based in Hongkong, we have already established firm and mutual-benefit business relationships with customers from,Europe,America and south Asia,supplying obsolete and hard-to-find components to meet their specific needs.

With the principle of “Quality Parts,Customers Priority,Honest Operation,and Considerate Service”,our business mainly focus on the distribution of electronic components. Line cards we deal with include Microchip,ALPS,ROHM,Xilinx,Pulse,ON,Everlight and Freescale. Main products comprise IC,Modules,Potentiometer,IC Socket,Relay,Connector.Our parts cover such applications as commercial,industrial, and automotives areas.

We are looking forward to setting up business relationship with you and hope to provide you with the best service and solution. Let us make a better world for our industry!



Contact us

Tel: +86-755-8981 8866 Fax: +86-755-8427 6832

Email & Skype: info@chipsmall.com Web: www.chipsmall.com

Address: A1208, Overseas Decoration Building, #122 Zhenhua RD., Futian, Shenzhen, China



F1300/F1350/F1399 RFI Filters

Features:

- T Circuit Configuration—Designed for Motor, Capacitive and Other Low Impedance Loads
- Dual Coils — Higher Performance in Unknown RFI and Noise Susceptibility Applications
- Integral IEC Connector and PC Mounted Versions Now Available



Nominal Current Rating	Part Number	Termination Line/Load	MINIMUM INSERTION LOSS - dB (50 ohm Circuit)						
			MODE	Frequency - MHz					
				.15	.50	1.0	5.0	10	30
1A	F1300AA01	QC/QC	Common	40	65	65	65	65	65
	F1300BB01	Wire/Wire	Differential	2	57	69	70	70	60
	F1350AA01	QC/QC	Common	30	60	65	65	65	65
	F1350BB01	Wire/Wire	Differential	2	57	69	70	70	60
2A	F1399AA02	QC/QC	Common	40	65	65	65	65	40
	F1399BB02	Wire/Wire	Differential	5	45	70	65	60	50
3A	F1300AA03	QC/QC	Common	40	65	65	65	65	65
	F1300BB03	Wire/Wire		Differential	7	64	70	70	70
	F1300CA03	IEC/QC	Common	30	60	65	65	65	65
	F1300CP03	IEC/PC		Differential	7	64	70	70	70
	F1399AA03	QC/QC	Common	40	65	65	65	65	40
	F1399BB03	Wire/Wire		Differential	12	55	70	65	60
F1399CA03	IEC/QC								
6A	F1300AA06	QC/QC	Common	12	48	60	65	65	65
	F1300BB06	Wire/Wire		Differential	10	40	70	70	70
	F1300CA06	IEC/QC	Common	2	40	60	65	65	65
	F1350AA06	QC/QC		Differential	10	40	70	70	70
	F1350BB06	Wire/Wire	Common	30	55	65	65	65	40
	F1350CA06	IEC/QC		Differential	5	40	70	65	60
F1399AA06	QC/QC								
10A	F1300AA10	QC/QC	Common	12	48	60	65	65	65
	F1300BB10	Wire/Wire		Differential	13	13	64	70	67
	F1300CA10	IEC/QC	Common	2	40	60	65	65	65
	F1350AA10	QC/QC		Differential	13	13	64	70	67
	F1399AA10	QC/QC	Common	5	40	52	60	60	50
	F1399BB10	Wire/Wire		Differential	5	12	50	65	60
F1399CA10	IEC/QC								
F1399DD10	Screw/Screw								
15A	F1300AA15	QC/QC	Common	14	35	44	56	58	55
			Differential	15	10	45	70	67	56
20A	F1300AA20	QC/QC	Common	5	44	60	65	65	60
			Differential	—	—	35	60	57	45
	F1350AA20	QC/QC	Common	2	35	61	63	60	50
			Differential	—	—	35	60	57	45
F1399AA20	QC/QC	Common	5	40	52	60	60	52	
F1399DD20	Screw/Screw		Differential	5	12	50	65	60	55

NOTE: Other combinations of terminals may be specified on special order.

Dimensions are in inches and millimeters unless otherwise specified. Values in parentheses are metric equivalents.



Curtis Industries
A Division of Powers Holdings, Inc.

1-800-657-0853

General Purpose

SINGLE PHASE FILTERS

F1300/F1350/F1399 RFI Filters (continued)

Specifications:

Rated Voltage: 250VAC Maximum - 50/60 Hz

Rated Current:

115VAC	1A	2A	3A	6A	10A	15A	20A
250VAC	1A	1.5A	2.5A	4A	6A	15A	16A

Current Overload: 6X for 8 seconds

Hi-Pot Test (1 min): **F1300/F1350**

Line to Ground: 1500VAC
Line to Line: 1768VDC

Insulation Resistance: $9 \times 10^9 \Omega$ at 100VDC

Ambient Temperature: 40°C Max. at rated current

Humidity Range: 0% to 95% R.H.

Termination: A: QC – Quick Connect C: IEC Receptacle
B: Wire P: PC – P.C. Board

Maximum Leakage Current: Each Line to Ground

	F1300	F1350	D1399	F1360	F1370	F1380	F1390
115VAC, 60Hz:	0.4mA	0.25mA	0.25mA	.15mA	.002mA	.015mA	.030mA
250VAC, 50Hz:	.75mA	.40mA	0.45mA	.25mA	.005mA	.025mA	.050mA

Agency Approvals:



General Purpose

SINGLE PHASE FILTERS

F1300AA (1, 3, 6, 10 and 15Amp) F1350AA (1, 3, 6 and 10Amp) Dimensions

Amps	A	B	C	D	E
1A	2.750 (69,9)	1.750 (44,5)	1.125 (28,5)	2.375 (60,3)	2.925 (74,3)
3A	3.312 (84,1)	2.000 (50,8)	1.125 (28,5)	2.940 (74,7)	3.49 (88,7)
6A	3.312 (84,1)	2.000 (50,8)	1.125 (28,5)	2.940 (74,7)	3.49 (88,7)
10A	3.312 (84,1)	2.000 (50,8)	1.500 (38,1)	2.940 (74,7)	3.49 (88,7)
15A	3.312 (84,1)	2.000 (50,8)	1.500 (38,1)	2.940 (74,7)	3.49 (88,7)

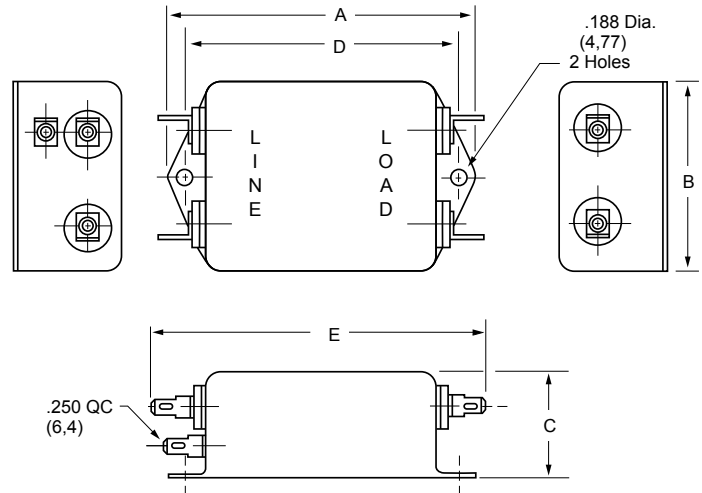

F1300BB/F1350BB (1, 3, 6 and 10Amp) Dimensions

Amps	A	B	C	D	E
1A	2.750 (69,9)	1.750 (44,5)	1.125 (28,5)	2.375 (60,3)	2.000 (50,8)
3A	3.312 (84,1)	2.000 (50,8)	1.125 (28,5)	2.940 (74,7)	2.500 (63,5)
6A	3.312 (84,1)	2.000 (50,8)	1.125 (28,5)	2.940 (74,7)	2.500 (63,5)
10A	3.312 (84,1)	2.000 (50,8)	1.500 (38,1)	2.940 (74,7)	2.500 (63,5)

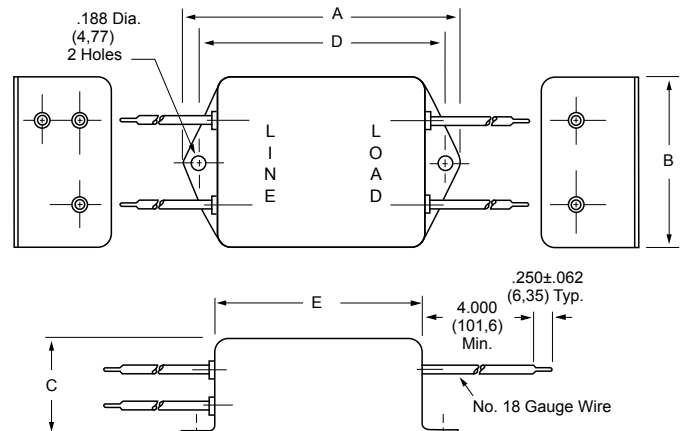

F1300/F1350 Simplified Schematic

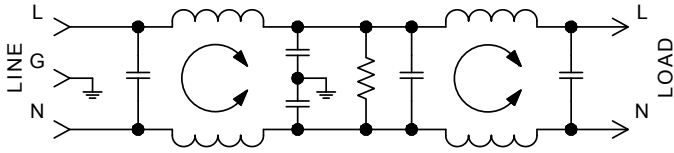

F1300CA (3, 6 and 10Amp) F1350CA (3 and 6Amp) Dimensions

Refer to Page 40
for Standard
Mounting Cutouts

Amps	A	B	C	D	E
3A	2.500 (63,6)	2.000 (50,8)	1.500 (38,1)	.550 (14,0)	.565 (14,3)
6A	2.500 (63,5)	2.000 (50,8)	1.500 (38,1)	.550 (14,0)	.565 (14,3)
10A	2.880 (73,1)	2.120 (53,8)	1.500 (38,1)	.65 (16,0)	.565 (14,3)

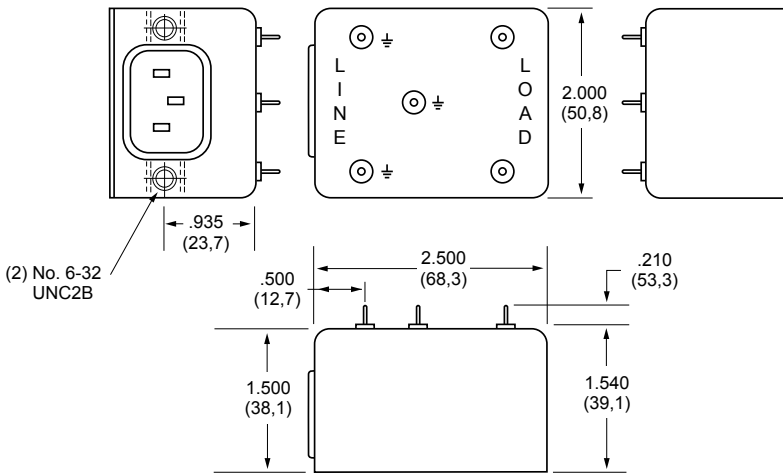
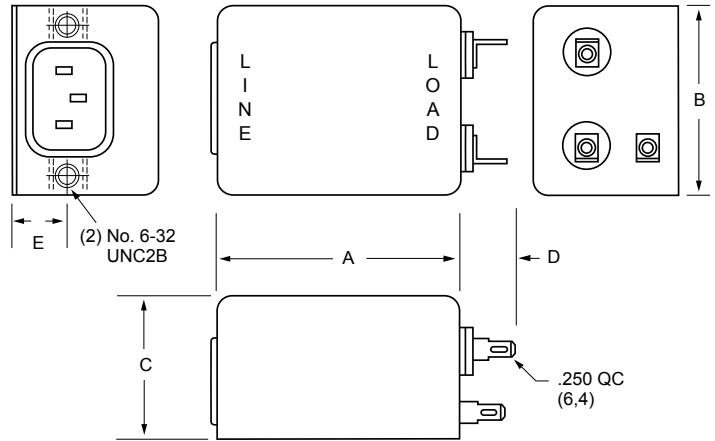

F1300CP/F1350CP (3Amp Only) Dimensions

Refer to Page 40
for Standard
Mounting Cutouts

F1300AA/F1350AA (20Amp Only) Dimensions

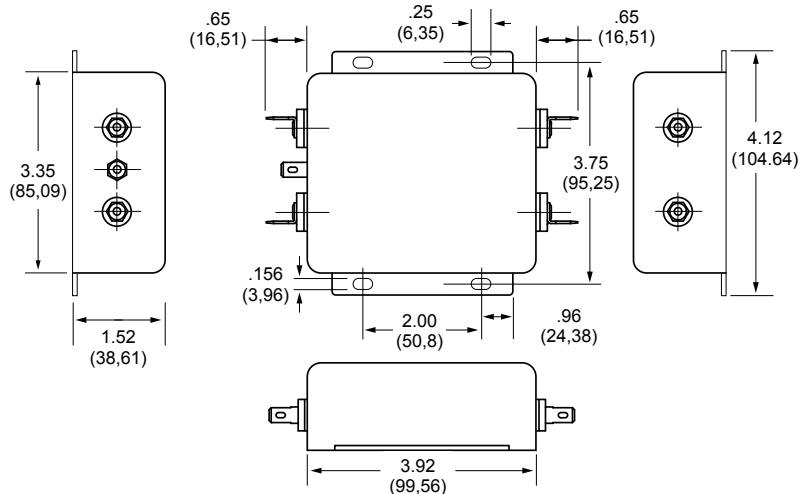

F1300/F1399 RFI Filters (continued)

General Purpose

SINGLE PHASE FILTERS

F1399 Simplified Schematic

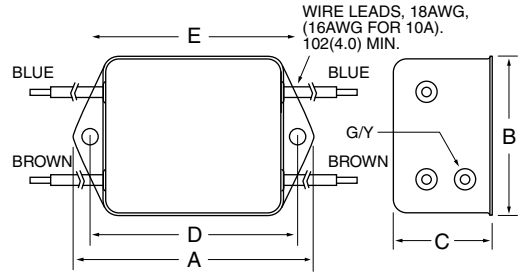
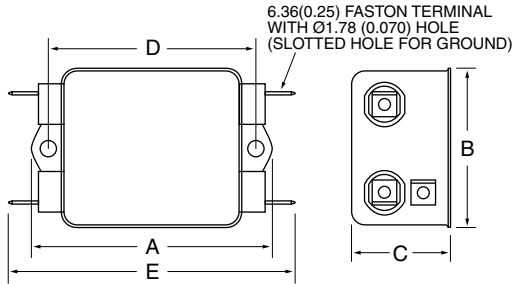
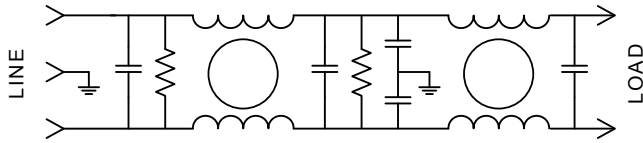

F1399BB (2, 3, 6 and 10Amp) Dimensions

Amps	A	B	C	D	E
2A	2.07 (52,6)	1.81 (46,0)	1.16 (29,5)	2.375 (60,33)	2.78 (70,6)
3A	2.56 (65,0)	2.07 (52,6)	1.16 (29,5)	2.938 (74,63)	3.35 (85,1)
6A	2.56 (65,0)	2.07 (52,6)	1.16 (29,5)	2.938 (74,63)	3.35 (85,1)
10A	2.56 (65,0)	2.07 (52,6)	1.53 (38,9)	2.938 (74,63)	3.35 (85,1)

F1399AA (2, 3, 6, 10 and 20Amp) Dimensions

Amps	A	B	C	D	E
2A	3.35 (85,1)	1.81 (46,0)	1.16 (29,5)	2.375 (60,33)	2.78 (70,6)
3A	3.85 (97,8)	2.07 (52,6)	1.16 (29,5)	2.938 (74,63)	3.35 (85,1)
6A	3.85 (97,8)	2.07 (52,6)	1.16 (29,5)	2.938 (74,63)	3.35 (85,1)
10A	3.85 (97,8)	2.07 (52,6)	1.53 (38,9)	2.938 (74,63)	3.35 (85,1)
20A	5.23 (132,8)	3.37 (85,6)	1.53 (38,9)	3.75 (95,25)	4.20 (106,7)

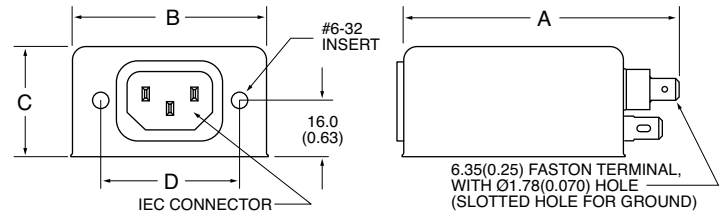

F1399CA (3, 6 and 10Amp) Dimensions

Amps	A	B	C	D
3A	4.33 (110,0)	2.25 (57,2)	1.28 (32,5)	1.575 (40,0)
6A	4.33 (110,0)	2.25 (57,2)	1.28 (32,5)	1.575 (40,0)
10A	4.33 (110,0)	2.25 (57,2)	1.53 (38,9)	1.575 (40,0)

F1399DD (10 and 20Amp) Dimensions

Amps	A	B	C	D	E
10A	3.96 (100,6)	2.07 (52,6)	1.53 (38,9)	2.938 (74,63)	3.35 (85,1)
20A	5.34 (135,6)	3.37 (85,6)	1.53 (38,9)	3.75 (95,25)	4.20 (106,7)

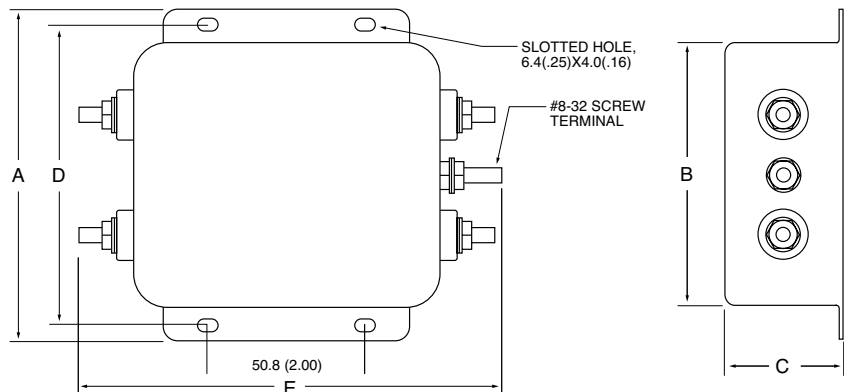
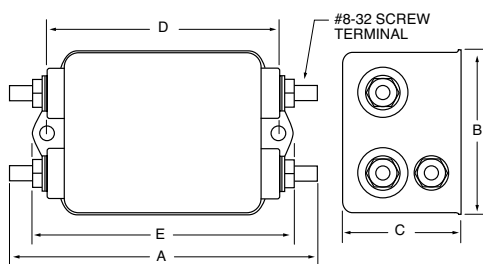

Standard Mounting Cutouts

F1200CA, F1300CA, F1400CA, F1500CA, F1600CA, F1700CA

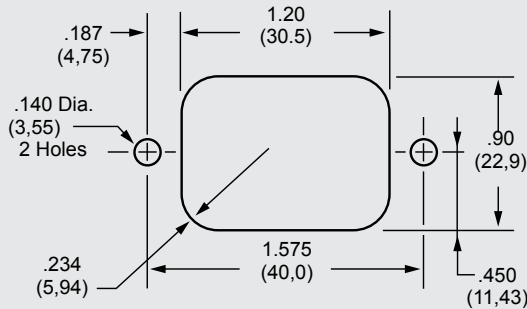

F1500FA, F1600FA,

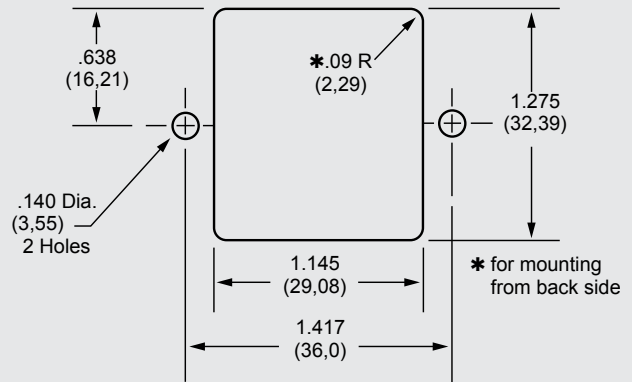

How to Order

The Curtis part numbering system is made up of four elements. Each element denotes a specific requirement (mechanical or electrical) which, when properly sequenced, fully identifies the required catalog filter. As shown, the first five alpha/numeric characters denote the series type; the sixth character (alpha) denotes the type of line termination; the seventh character (alpha) denotes the type of load termination; the last two characters (numeric) denote the current rating.

Compose your part number as follows: Select the series required, add two alpha character for the line and load termination, followed by two numeric characters for the required current rating. For example, F1100AB06 completely identifies an F1100 series filter with quick connects on line side and wire leads on load side, with a 6-amp rating.

SINGLE PHASE FILTERS

F1300CP, F1600CP

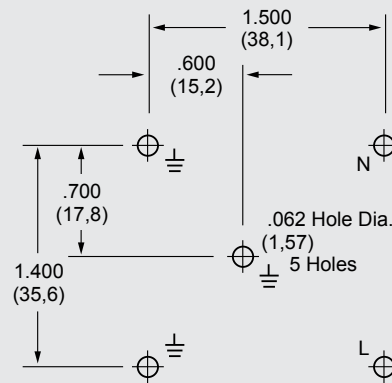

F5500/5600/5700 SERIES

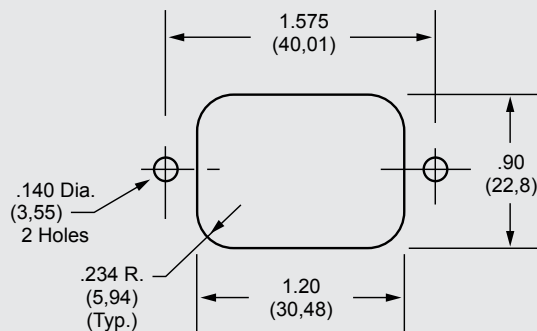

F1100	X	X	X
SERIES	LINE TERMINATION	LOAD TERMINATION	CURRENT RATING
PE = Power Entry PM = Medical Power Entry	A = Quick Connects B = Wire Leads C = IEC Connector D = Screw Terminals (20 & 30 amp only) F = Fused IEC P = Printed Circuit Pins W = Dual Fused IEC J = Switched IEC	A = Quick Connects B = Wire Leads D = Screw Terminals (20 & 30 amp only) P = Printed Circuit Pins S = Solder Tab	01 = 1 Amp 03 = 3 Amps 06 = 6 Amps 10 = 10 Amps 15 = 15 Amps 20 = 20 Amps 30 = 30 Amps

