



Chipsmall Limited consists of a professional team with an average of over 10 year of expertise in the distribution of electronic components. Based in Hongkong, we have already established firm and mutual-benefit business relationships with customers from,Europe,America and south Asia,supplying obsolete and hard-to-find components to meet their specific needs.

With the principle of "Quality Parts,Customers Priority,Honest Operation,and Considerate Service",our business mainly focus on the distribution of electronic components. Line cards we deal with include Microchip,ALPS,ROHM,Xilinx,Pulse,ON,Everlight and Freescale. Main products comprise IC,Modules,Potentiometer,IC Socket,Relay,Connector.Our parts cover such applications as commercial,industrial, and automotives areas.

We are looking forward to setting up business relationship with you and hope to provide you with the best service and solution. Let us make a better world for our industry!



Contact us

Tel: +86-755-8981 8866 Fax: +86-755-8427 6832

Email & Skype: info@chipsmall.com Web: www.chipsmall.com

Address: A1208, Overseas Decoration Building, #122 Zhenhua RD., Futian, Shenzhen, China



FLORENCE-1R-Z90

~90° + 110° wide beam

TECHNICAL SPECIFICATIONS:

Dimensions	19.5 x 286.0 mm
Height	7 mm
Fastening	clips
Colour	clear
Box size	398 x 298 x 265 mm
Box weight	7.5 kg
Quantity in Box	165 pcs
ROHS compliant	yes ⓘ

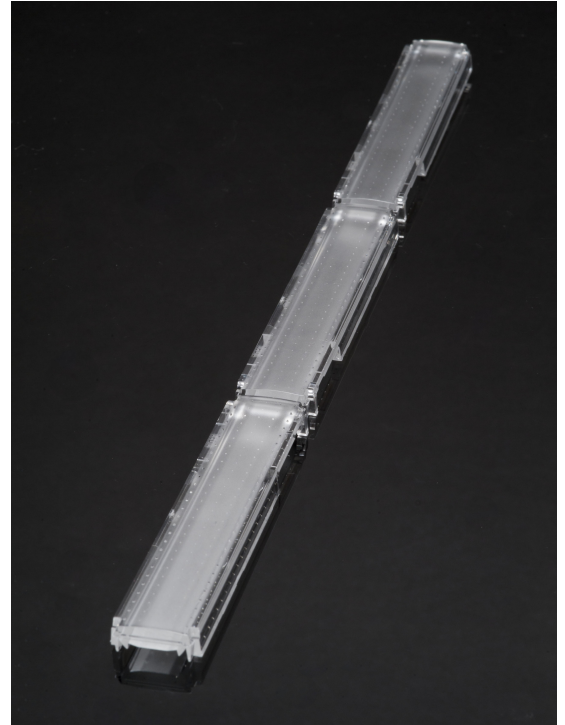

MATERIAL SPECIFICATIONS:

Component	Type	Material	Colour
FLORENCE-1R-Z90	Lens	PMMA	clear

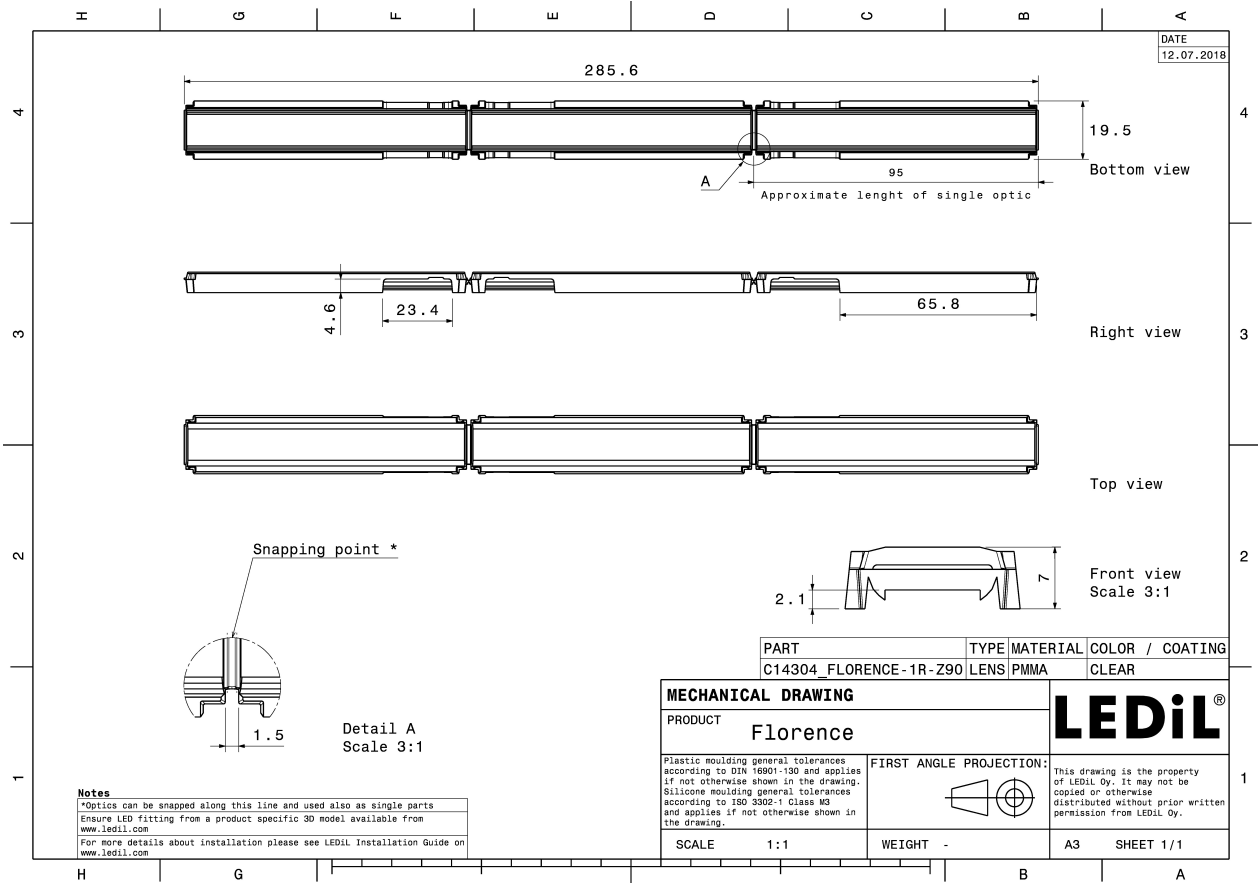

PHOTOMETRIC DATA (MEASURED):



LED CALGD0414-M8W1
FWHM 89.0 + 115.0°
Efficiency 93 %
Peak intensity 0.380 cd/lm
Required components:

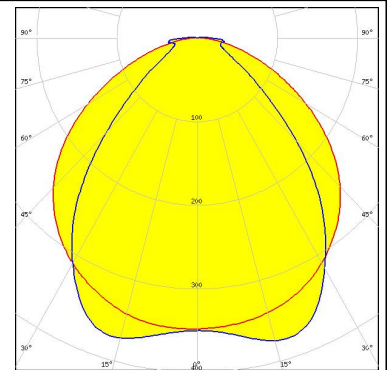

LED CALGD0814-M17W1
FWHM 90.0 + 114.0°
Efficiency 93 %
Peak intensity 0.380 cd/lm
Required components:

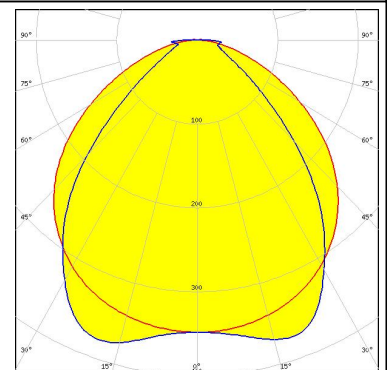

LED L0-280024-xxx-C0800-L267
FWHM 88.0 + 106.0°
Efficiency 92 %
Peak intensity 0.400 cd/lm
Required components:

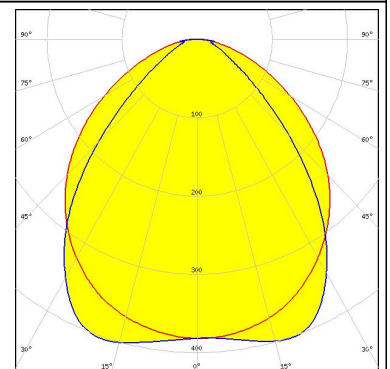
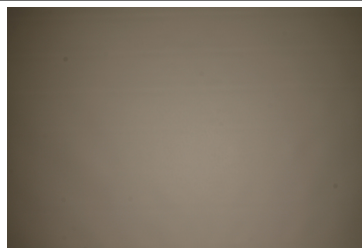

LED XH-B/G
FWHM 97.0 + 117.0°
Efficiency 90 %
Peak intensity 0.350 cd/lm
Required components:

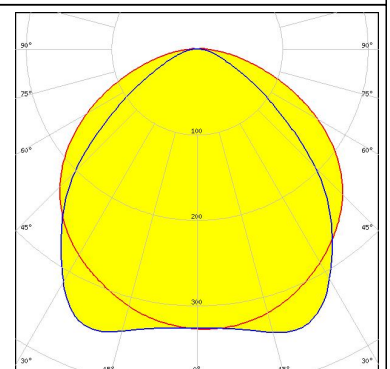
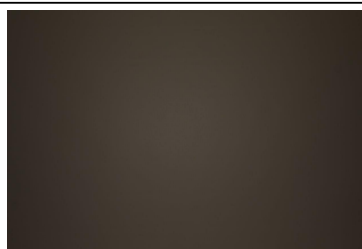

PHOTOMETRIC DATA (MEASURED):

LUMILEDS

LED LUXEON 3014
FWHM 91.0 + 109.0°
Efficiency 94 %
Peak intensity 0.420 cd/lm
Required components:

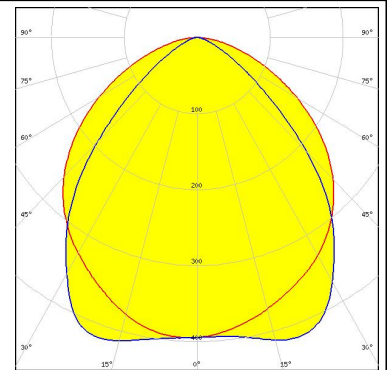

LUMILEDS

LED LUXEON 3020
FWHM 89.0 + 108.0°
Efficiency 94 %
Peak intensity 0.430 cd/lm
Required components:

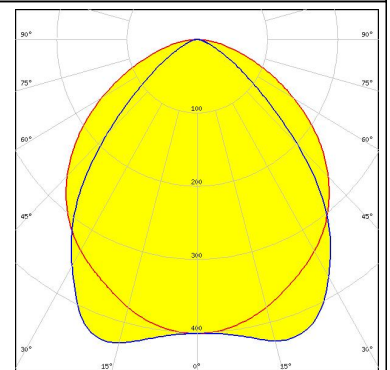
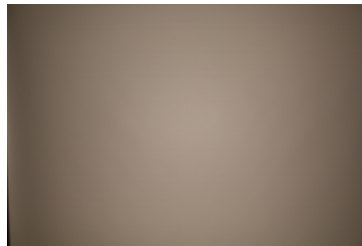

LUMILEDS

LED LUXEON 3030 2D (Round LES)
FWHM 88.0 + 108.0°
Efficiency 92 %
Peak intensity 0.420 cd/lm
Required components:

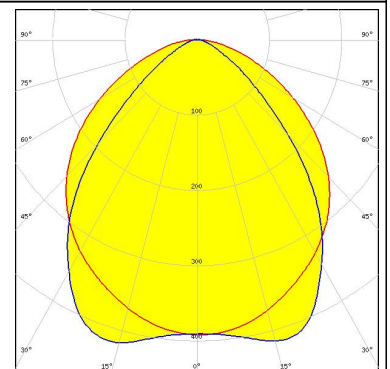
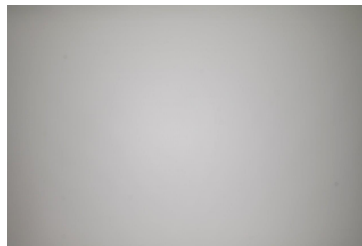

LUMILEDS

LED LUXEON 3535 2D
FWHM 92.0 + 110.0°
Efficiency 93 %
Peak intensity 0.390 cd/lm
Required components:

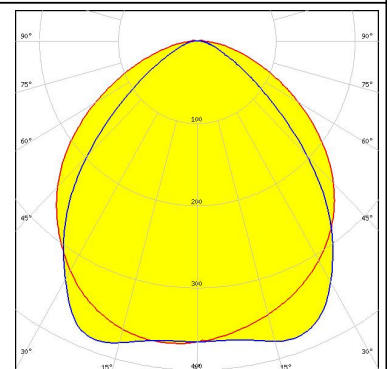
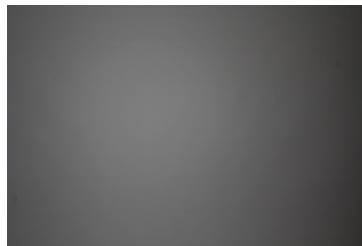

PHOTOMETRIC DATA (MEASURED):



LED LUXEON 3535L
 FWHM 92.0 + 109.0°
 Efficiency 94 %
 Peak intensity 0.410 cd/lm
 Required components:

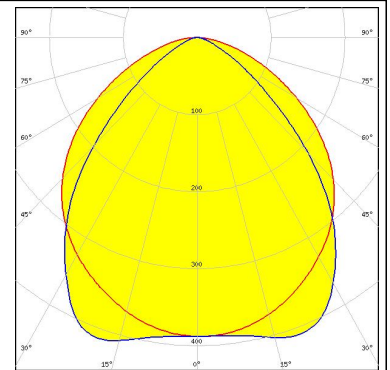

LED MP-2016
 FWHM 89.0 + 108.0°
 Efficiency 93 %
 Peak intensity 0.420 cd/lm
 Required components:

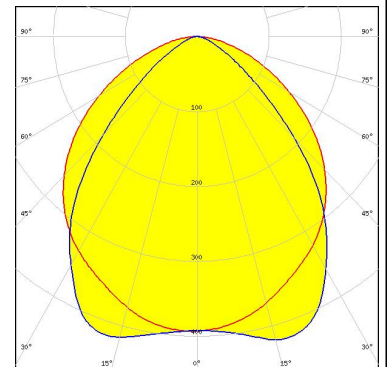
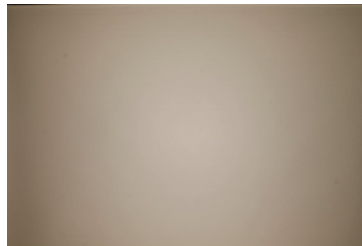

LED NF2x757D
 FWHM 90.0 + 110.0°
 Efficiency 93 %
 Peak intensity 0.400 cd/lm
 Required components:

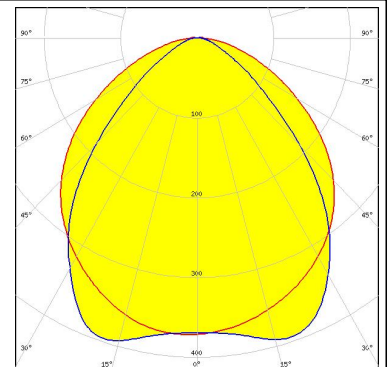

LED NF2x757G
 FWHM 90.0 + 108.0°
 Efficiency 92 %
 Peak intensity 0.400 cd/lm
 Required components:

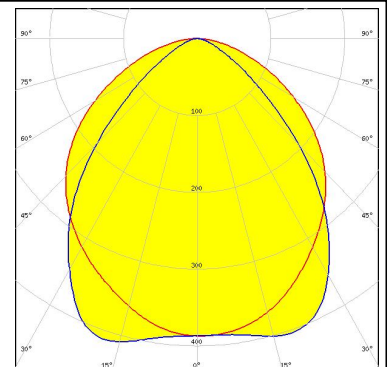
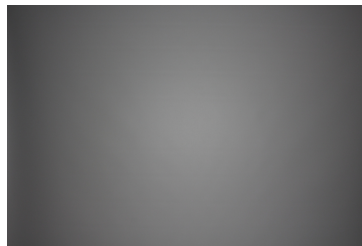

PHOTOMETRIC DATA (MEASURED):

OSRAM
Opto Semiconductors

LED Duris S5 (2 chip)
FWHM 90.0 + 113.0°
Efficiency 94 %
Peak intensity 0.400 cd/lm
Required components:

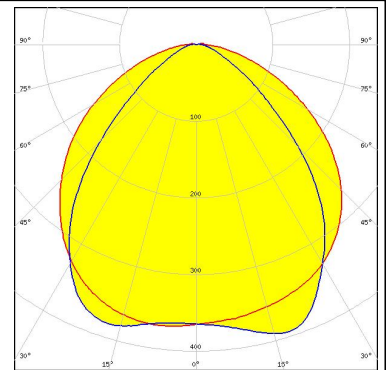

PHILIPS

LED Fortimo LED Line 1ft 1100lm xx0 1R xV2/x
FWHM 90.0 + 110.0°
Efficiency 94 %
Peak intensity 0.410 cd/lm
Required components:

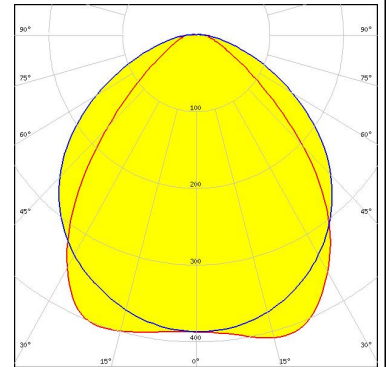
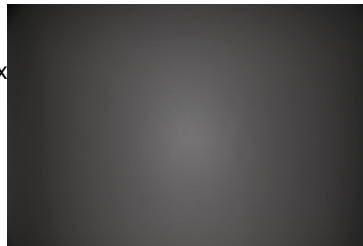

SAMSUNG

LED LM28xB Series
FWHM 91.0 + 111.0°
Efficiency 94 %
Peak intensity 0.420 cd/lm
Required components:

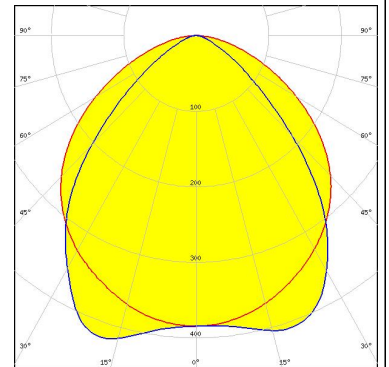
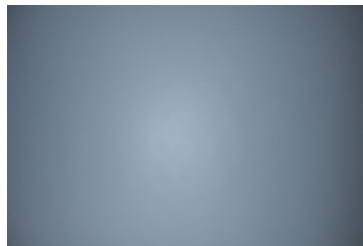

SAMSUNG

LED LM301A
FWHM 89.0 + 109.0°
Efficiency 94 %
Peak intensity 0.430 cd/lm
Required components:

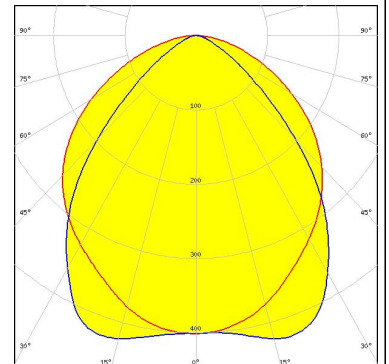
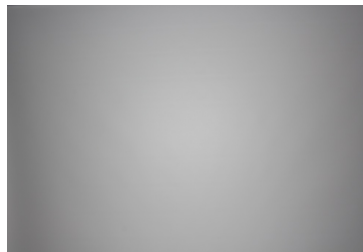

PHOTOMETRIC DATA (MEASURED):

SAMSUNG

LED LM302A
FWHM 90.0 + 108.0°
Efficiency 93 %
Peak intensity 0.410 cd/lm
Required components:

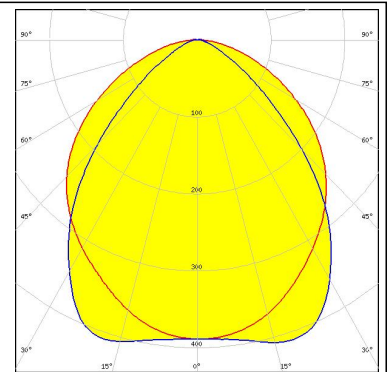
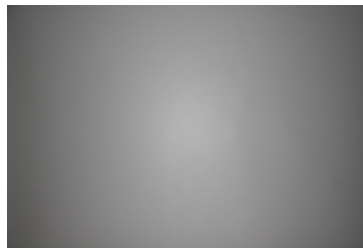

SAMSUNG

LED LM561B
FWHM 91.0 + 109.0°
Efficiency 93 %
Peak intensity 0.390 cd/lm
Required components:

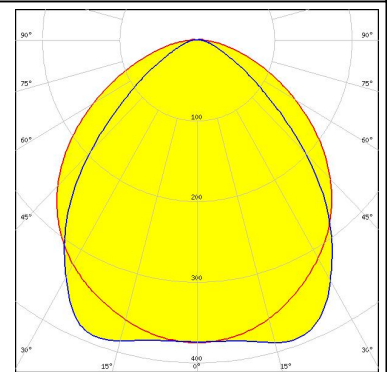
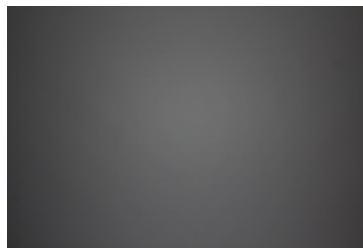

SAMSUNG

LED LM561C
FWHM 90.0 + 110.0°
Efficiency 94 %
Peak intensity 0.420 cd/lm
Required components:

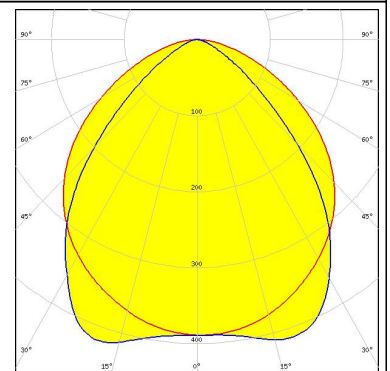
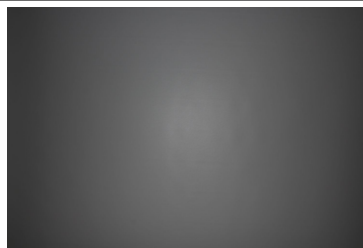

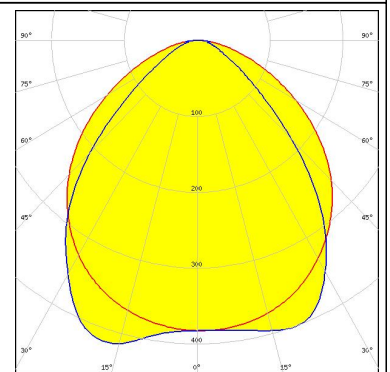

SAMSUNG

LED LT-S282N
FWHM 91.0 + 109.0°
Efficiency 94 %
Peak intensity 0.420 cd/lm
Required components:

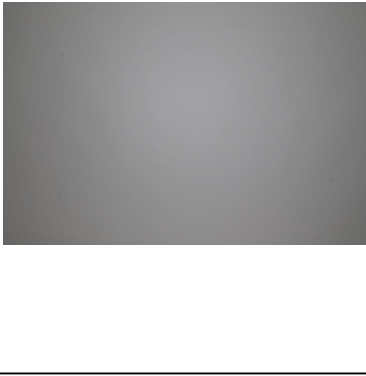
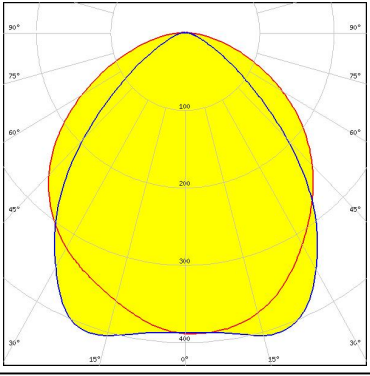

PHOTOMETRIC DATA (MEASURED):

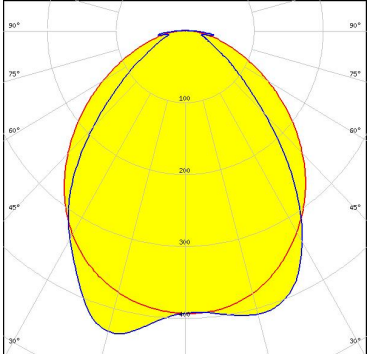
<p> SEOUL SEMICONDUCTOR</p> <p>LED SEOUL 3030 FWHM 90.0 + 109.0° Efficiency 92 % Peak intensity 0.410 cd/lm Required components:</p>		 <p>A photometric beam spread diagram for the Seoul LED. It shows a yellow beam spread on a grid with angles from 30° to 90°. The beam is wider at the top and tapers towards the bottom. The grid lines are labeled with angles: 30°, 45°, 60°, 75°, and 90° on both the vertical and horizontal axes.</p>
<p> SEOUL SEMICONDUCTOR</p> <p>LED SunLike 3030 FWHM 103.0 + 86.0° Efficiency 94 % Peak intensity 0.430 cd/lm Required components: C14353_FLORENCE-1R-CLIP-A</p>		 <p>A photometric beam spread diagram for the SunLike LED. It shows a yellow beam spread on a grid with angles from 30° to 90°. The beam is wider at the top and tapers towards the bottom. The grid lines are labeled with angles: 30°, 45°, 60°, 75°, and 90° on both the vertical and horizontal axes.</p>

PHOTOMETRIC DATA (SIMULATED):

LUMILEDS

LED LUXEON 2835 Line
FWHM 90.0 + 111.0°
Efficiency 93 %
Peak intensity 0.410 cd/lm
Required components:

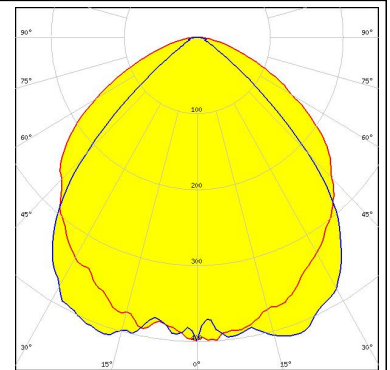

LUMILEDS

LED LUXEON 5050
FWHM 91.0 + 111.0°
Efficiency 94 %
Peak intensity 0.410 cd/lm
Required components:

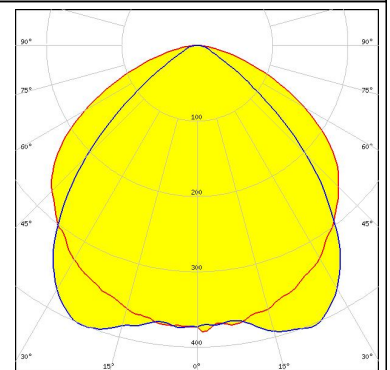

OSRAM

Opto Semiconductors

LED Duris E 2835
FWHM 94.0 + 106.0°
Efficiency 93 %
Peak intensity 0.390 cd/lm
Required components:

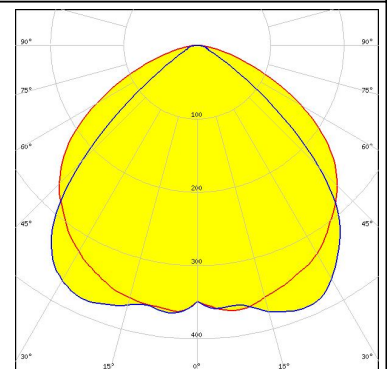

GENERAL INFORMATION:

NOTE: The typical beam angle will be changed by different color, chip size and chip position tolerance. The typical total beam angle is the full angle measured where the luminous intensity is half of the peak value.

MATERIALS:

As part of our continuous research and improvement processes, and to ensure the best possible quality and availability of our products, LEDiL reserves the right to change material grades without notice.

PRODUCT DATA USER AGREEMENT AND DISCLAIMER:

The measured data in the provided downloadable LEDiL Product Datasheets and Mechanical 2D-Drawings is rounded and provided as reference for planning. LEDiL Oy's optical specifications have been verified by conducting performance testing of the products in accordance with the company's quality system. The reported data are averaged results of multiple measurements with typical variation. LEDiL Oy reserves the right to without prior notification make changes and improvements to its products.

LEDiL Oy assumes neither warranty, nor guarantee nor any other liability of any kind for the contents and correctness of the provided data. The provided data has been generated with highest diligence but the provided data may in reality not represent the complete possible variation range of all intrinsic parameters. Therefore, in certain cases a deviation from the provided data could occur.

LEDiL Oy reserves the right to undertake technical changes of its products without further notification which could lead to changes in the provided data. LEDiL Oy assumes no liability of any kind for the possible deviation from any provided data or any other damage resulting from the usage of the provided data.

The user agrees to this disclaimer and user agreement with the download or usage of the provided files.

LEDiL Oy

Joensuunkatu 13
FI-24240 SALO
Finland

LEDiL Inc.

228 West Page Street
Suite D
Sycamore IL 60178
USA

Local sales and technical support

[www.ledil.com/
where_to_buy](http://www.ledil.com/where_to_buy)

Shipping locations

Salo, Finland
Hong Kong, China

Distribution Partners

[www.ledil.com/
where_to_buy](http://www.ledil.com/where_to_buy)