



Chipsmall Limited consists of a professional team with an average of over 10 year of expertise in the distribution of electronic components. Based in Hongkong, we have already established firm and mutual-benefit business relationships with customers from,Europe,America and south Asia,supplying obsolete and hard-to-find components to meet their specific needs.

With the principle of “Quality Parts,Customers Priority,Honest Operation,and Considerate Service”,our business mainly focus on the distribution of electronic components. Line cards we deal with include Microchip,ALPS,ROHM,Xilinx,Pulse,ON,Everlight and Freescale. Main products comprise IC,Modules,Potentiometer,IC Socket,Relay,Connector.Our parts cover such applications as commercial,industrial, and automotives areas.

We are looking forward to setting up business relationship with you and hope to provide you with the best service and solution. Let us make a better world for our industry!



Contact us

Tel: +86-755-8981 8866 Fax: +86-755-8427 6832

Email & Skype: info@chipsmall.com Web: www.chipsmall.com

Address: A1208, Overseas Decoration Building, #122 Zhenhua RD., Futian, Shenzhen, China



ANGELETTE-WW-B-PLAIN

~60° wide beam. Clean appearance with no additional attachment interface and compatible with BJB connectors.

TECHNICAL SPECIFICATIONS:

Dimensions	Ø 110 mm
Height	57.3 mm
Fastening	socket
Colour	metal
Box size	398 x 298 x 265 mm
Box weight	5.3 kg
Quantity in Box	120 pcs
ROHS compliant	yes ⓘ



MATERIAL SPECIFICATIONS:

Component	Type	Material	Colour	Coating
ANGELETTE-WW-B-PLAIN	Reflector	PC	metal	HMDS

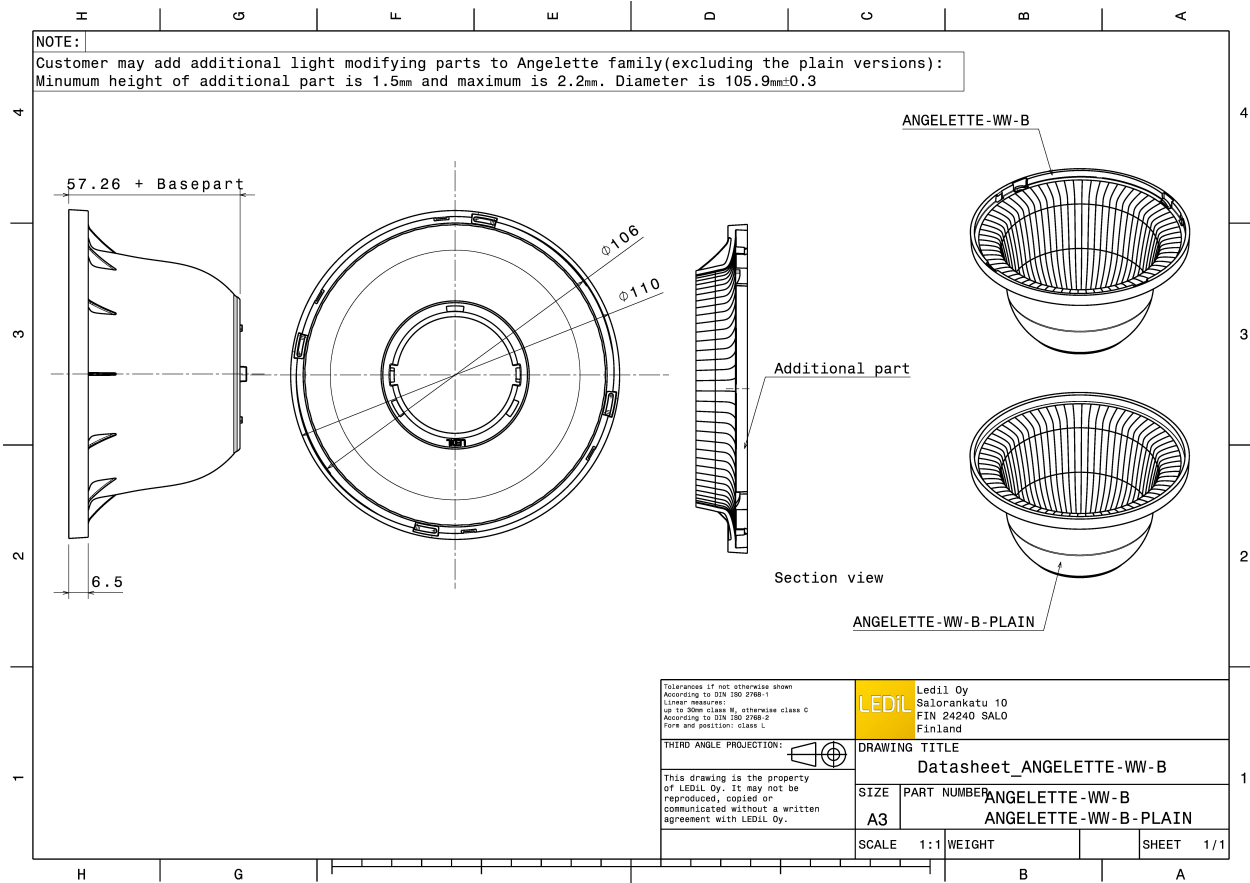

PHOTOMETRIC DATA (MEASURED):

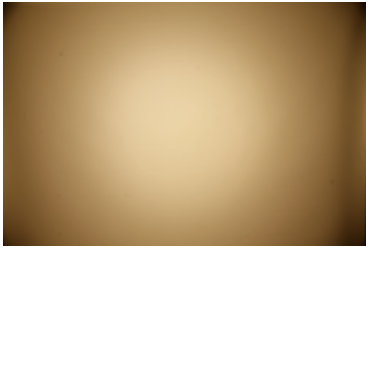
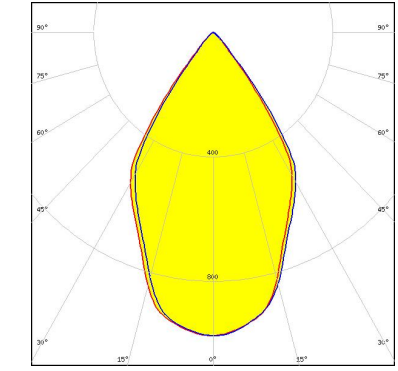
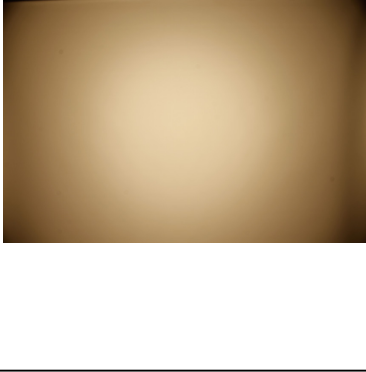
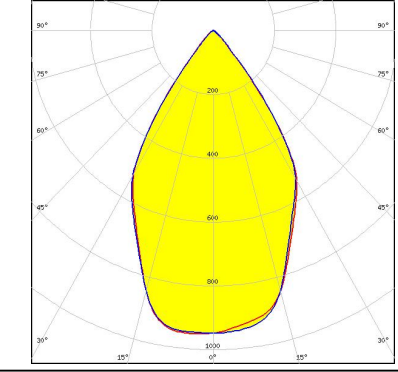
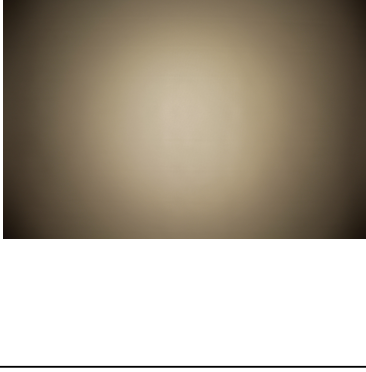
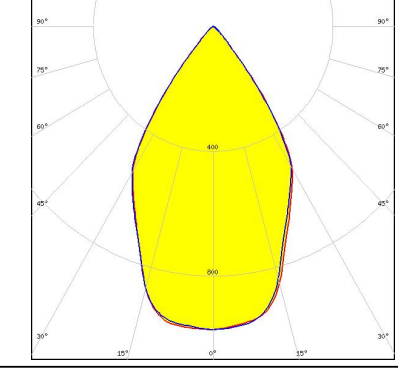
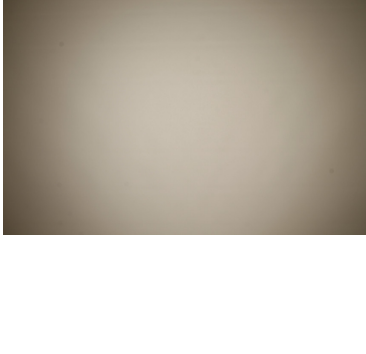
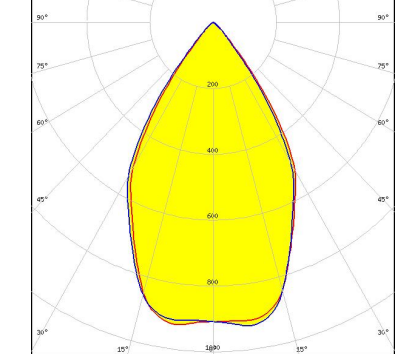
<p>bridgelux.</p> <p>LED V15 Gen6</p> <p>FWHM 65.0°</p> <p>Efficiency 89 %</p> <p>Peak intensity 0.980 cd/lm</p> <p>Required components:</p> <p>BJB: 47.319.2224</p>		
<p>bridgelux.</p> <p>LED V18 Gen6</p> <p>FWHM 64.0°</p> <p>Efficiency 89 %</p> <p>Peak intensity 0.950 cd/lm</p> <p>Required components:</p> <p>BJB: 47.319.2274</p>		
<p>bridgelux.</p> <p>LED V18 Gen7</p> <p>FWHM 64.0°</p> <p>Efficiency 89 %</p> <p>Peak intensity 0.970 cd/lm</p> <p>Required components:</p> <p>BJB: 47.319.2350</p>		
<p>bridgelux.</p> <p>LED V22 Gen6</p> <p>FWHM 63.0°</p> <p>Efficiency 87 %</p> <p>Peak intensity 0.930 cd/lm</p> <p>Required components:</p> <p>A.A.G. STUCCHI: 8102/G2</p>		

PHOTOMETRIC DATA (MEASURED):



LED CXA/B 25xx
FWHM 62.0°
Efficiency 89 %
Peak intensity 1.010 cd/lm
Required components:

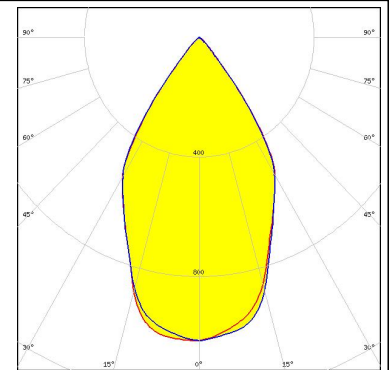
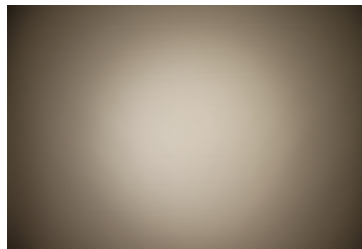

LED LUXEON CoB 1208
FWHM 63.0°
Efficiency 89 %
Peak intensity 1.000 cd/lm
Required components:
A.A.G. STUCCHI: 8301/G2

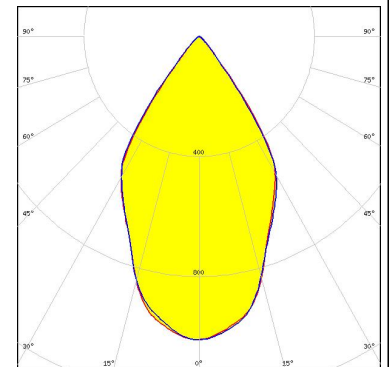

LED COB D Series LES 14.5 mm
FWHM 66.0°
Efficiency 86 %
Peak intensity 0.860 cd/lm
Required components:
F13671_ANGE-RZ-LENS
BJB: 47.319.2021

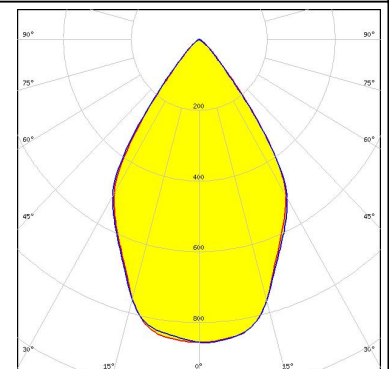

LED COB D Series LES 14.5 mm
FWHM 65.0°
Efficiency 90 %
Peak intensity 0.990 cd/lm
Required components:
A.A.G. STUCCHI: 8101/G2

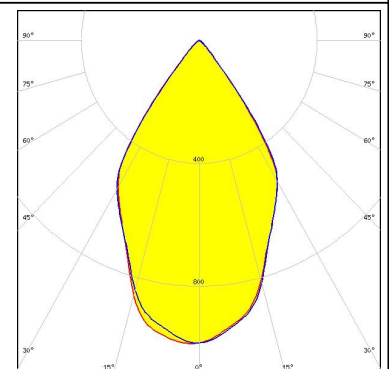
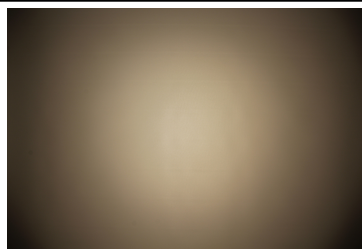

PHOTOMETRIC DATA (MEASURED):

SAMSUNG

LED COB D Series LES 14.5 mm

FWHM 66.0°

Efficiency 86 %

Peak intensity 0.860 cd/lm

Required components:

F13671_ANGE-RZ-LENS

A.A.G. STUCCHI: 8101/G2

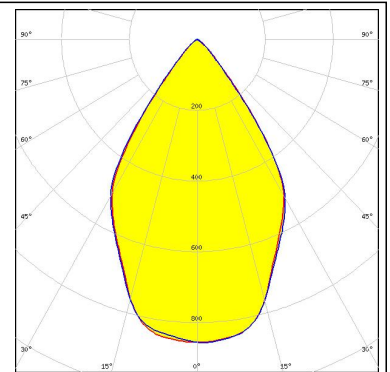

SAMSUNG

LED COB D Series LES 14.5 mm

FWHM 65.0°

Efficiency 90 %

Peak intensity 0.990 cd/lm

Required components:

BJB: 47.319.2021

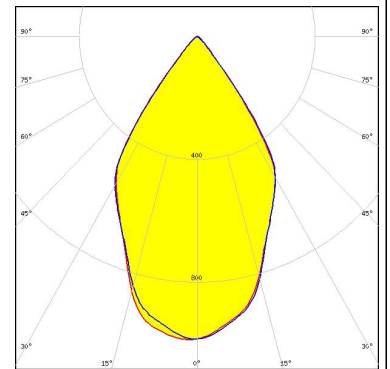
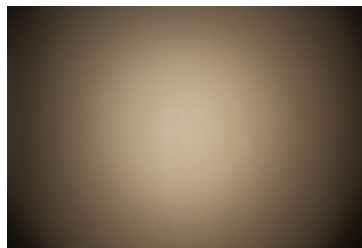

PHOTOMETRIC DATA (SIMULATED):

CITIZEN

LED CLL03x/CLU03x
FWHM 52.0°
Efficiency 94 %
Peak intensity 1.300 cd/lm
Required components:
BJB: 47.319.2021

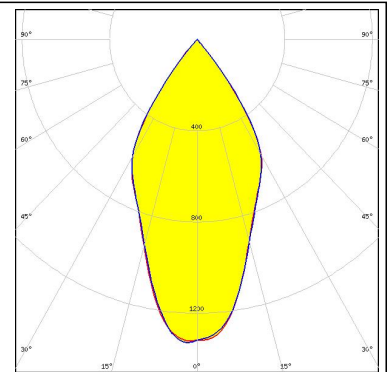

SAMSUNG

LED COB D Series LES 22 mm
FWHM 60.0°
Efficiency 87 %
Peak intensity 1.040 cd/lm
Required components:
BJB: 47.319.2030

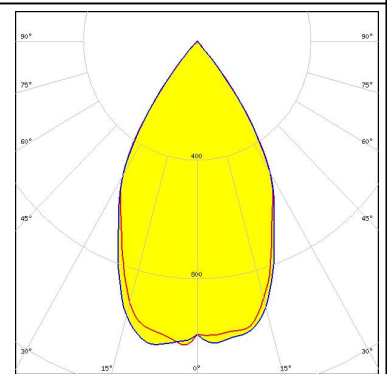

GENERAL INFORMATION:

NOTE: The typical beam angle will be changed by different color, chip size and chip position tolerance. The typical total beam angle is the full angle measured where the luminous intensity is half of the peak value.

Due to use of high power COB's with this product, special attention to proper thermal design is highly recommended. LEDiL has no liability for direct, indirect or consecutive damages arising from the LEDiL products being used outside of the recommended temperature range.

MATERIALS:

As part of our continuous research and improvement processes, and to ensure the best possible quality and availability of our products, LEDiL reserves the right to change material grades without notice.

PRODUCT DATA USER AGREEMENT AND DISCLAIMER:

The measured data in the provided downloadable LEDiL Product Datasheets and Mechanical 2D-Drawings is rounded and provided as reference for planning. LEDiL Oy's optical specifications have been verified by conducting performance testing of the products in accordance with the company's quality system. The reported data are averaged results of multiple measurements with typical variation. LEDiL Oy reserves the right to without prior notification make changes and improvements to its products.

LEDiL Oy assumes neither warranty, nor guarantee nor any other liability of any kind for the contents and correctness of the provided data. The provided data has been generated with highest diligence but the provided data may in reality not represent the complete possible variation range of all intrinsic parameters. Therefore, in certain cases a deviation from the provided data could occur.

LEDiL Oy reserves the right to undertake technical changes of its products without further notification which could lead to changes in the provided data. LEDiL Oy assumes no liability of any kind for the possible deviation from any provided data or any other damage resulting from the usage of the provided data.

The user agrees to this disclaimer and user agreement with the download or usage of the provided files.

LEDiL Oy

Joensuunkatu 13
FI-24240 SALO
Finland

LEDiL Inc.

228 West Page Street
Suite D
Sycamore IL 60178
USA

Local sales and technical support

www.ledil.com/where_to_buy

Shipping locations

Salo, Finland
Hong Kong, China

Distribution Partners

www.ledil.com/where_to_buy