



Chipsmall Limited consists of a professional team with an average of over 10 year of expertise in the distribution of electronic components. Based in Hongkong, we have already established firm and mutual-benefit business relationships with customers from,Europe,America and south Asia,supplying obsolete and hard-to-find components to meet their specific needs.

With the principle of “Quality Parts,Customers Priority,Honest Operation,and Considerate Service”,our business mainly focus on the distribution of electronic components. Line cards we deal with include Microchip,ALPS,ROHM,Xilinx,Pulse,ON,Everlight and Freescale. Main products comprise IC,Modules,Potentiometer,IC Socket,Relay,Connector.Our parts cover such applications as commercial,industrial, and automotives areas.

We are looking forward to setting up business relationship with you and hope to provide you with the best service and solution. Let us make a better world for our industry!



Contact us

Tel: +86-755-8981 8866 Fax: +86-755-8427 6832

Email & Skype: info@chipsmall.com Web: www.chipsmall.com

Address: A1208, Overseas Decoration Building, #122 Zhenhua RD., Futian, Shenzhen, China



LINNEA-O-B

~35° 70° oval beam optimized for 0.5 mm metal sheet or profile

TECHNICAL SPECIFICATIONS:

Dimensions	280x40 mm
Height	10.5 mm
Fastening	clips
Colour	clear
Box size	578 x 378 x 295 mm
Box weight	7.3 kg
Quantity in Box	180 pcs
ROHS compliant	yes ⓘ



MATERIAL SPECIFICATIONS:

Component	Type	Material	Colour
LINNEA-O-B	Lens	PC	clear

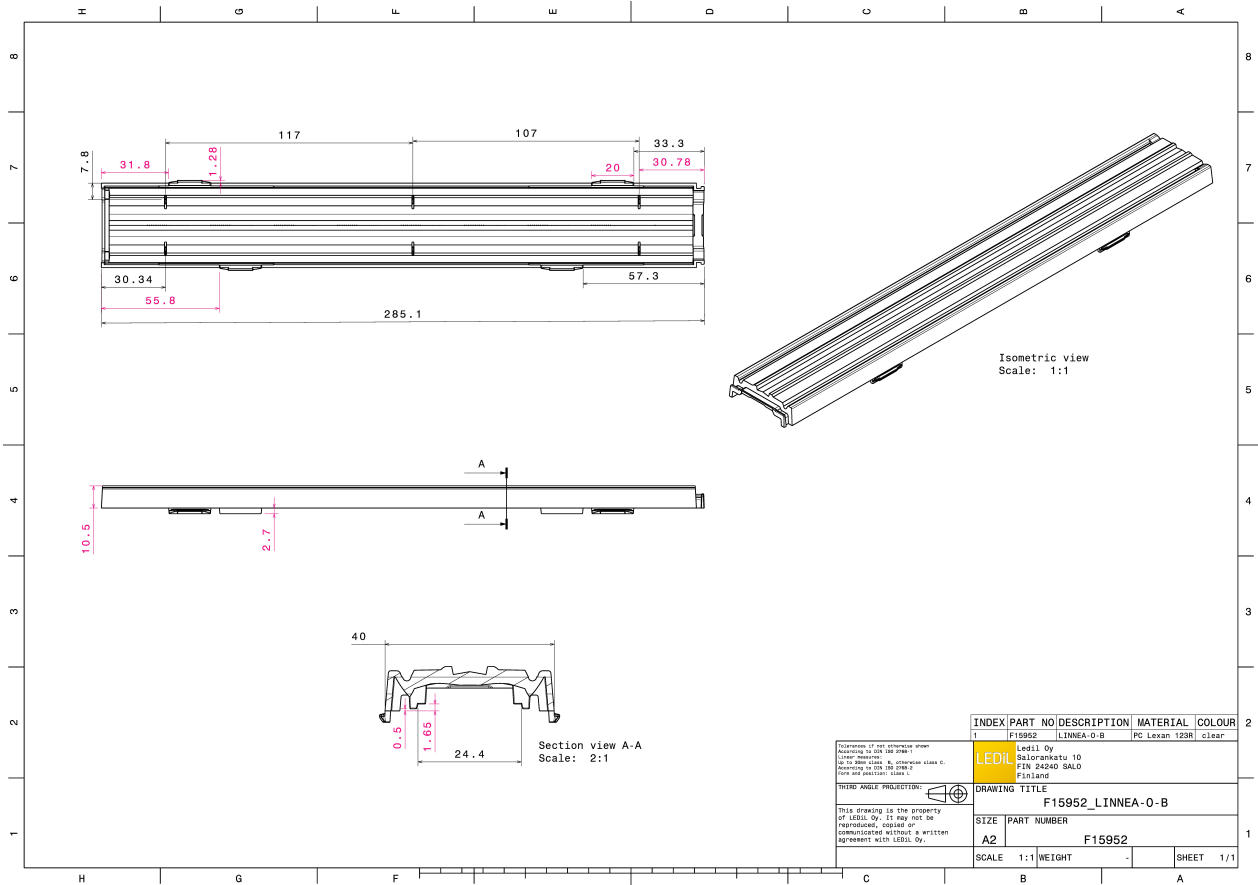

PHOTOMETRIC DATA (MEASURED):



LED XP-E
FWHM 90.0 + 35.0°
Efficiency 81 %
Peak intensity 0.720 cd/lm
Required components:

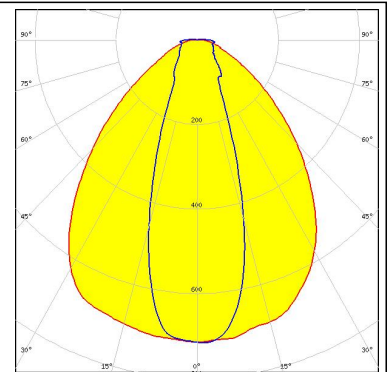

LED NFSx757G
FWHM 87.0 + 38.0°
Efficiency 81 %
Peak intensity 0.700 cd/lm
Required components:

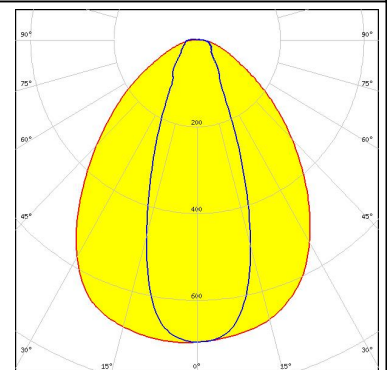
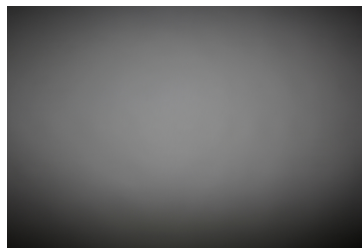

LED PrevaLED Linear Slim 3 (2000lm)
FWHM 91.0 + 38.0°
Efficiency 82 %
Peak intensity 0.710 cd/lm
Required components:

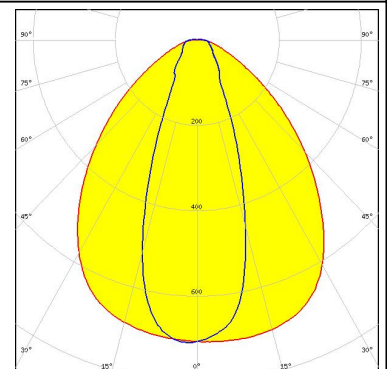
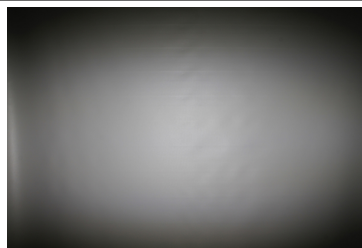

LED Duris S5 (2 chip)
FWHM 90.0 + 38.0°
Efficiency 83 %
Peak intensity 0.710 cd/lm
Required components:

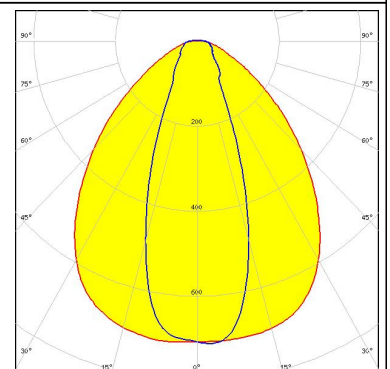
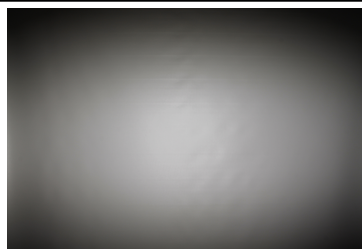

PHOTOMETRIC DATA (MEASURED):

OSRAM
Opto Semiconductors

LED Duris S5 (Single chip)
FWHM 91.0 + 38.0°
Efficiency 85 %
Peak intensity 0.720 cd/lm
Required components:

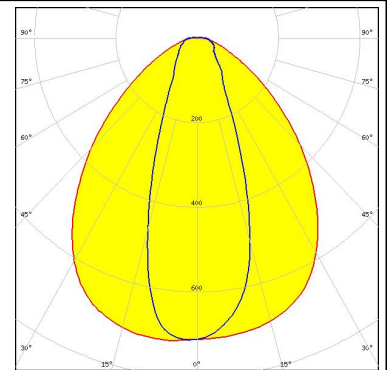
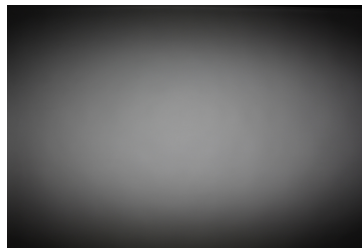

PHILIPS

LED Fortimo LED Strip 1ft 1100lm FC HV4 & LV4
FWHM 92.0 + 40.0°
Efficiency 83 %
Peak intensity 0.690 cd/lm
Required components:

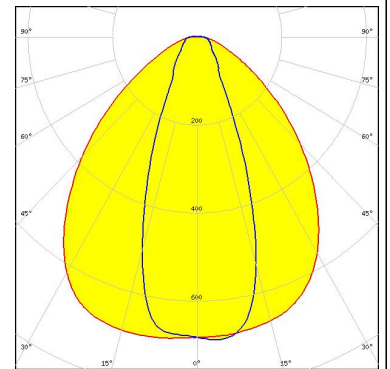
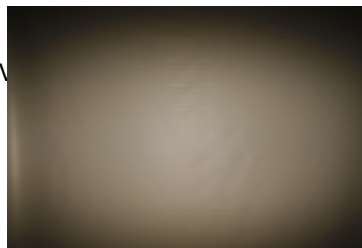

PHILIPS

LED Fortimo LED Strip 1ft 650lm FC HV4 & LV4
FWHM 93.0 + 40.0°
Efficiency 83 %
Peak intensity 0.690 cd/lm
Required components:

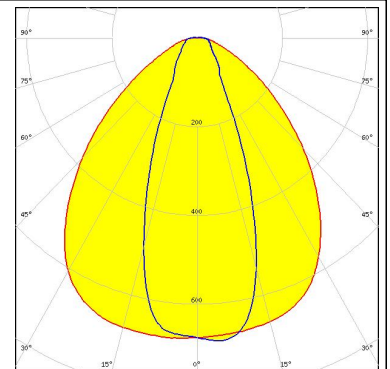
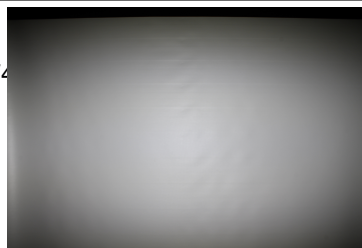

SAMSUNG

LED LM561B Plus
FWHM 35.0 + 70.0°
Efficiency 81 %
Peak intensity 0.820 cd/lm
Required components:

PHOTOMETRIC DATA (MEASURED):

SAMSUNG

LED LT-H282C
FWHM 88.0 + 33.0°
Efficiency 83 %
Peak intensity 0.770 cd/lm
Required components:

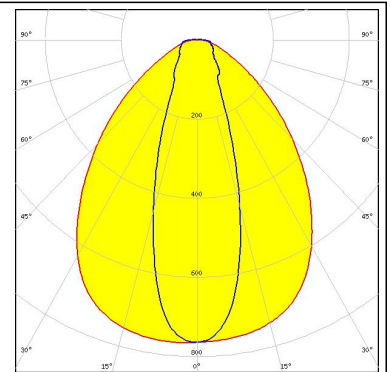
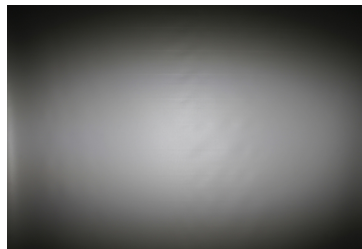

SAMSUNG

LED LT-H562C
FWHM 88.0 + 33.0°
Efficiency 83 %
Peak intensity 0.770 cd/lm
Required components:

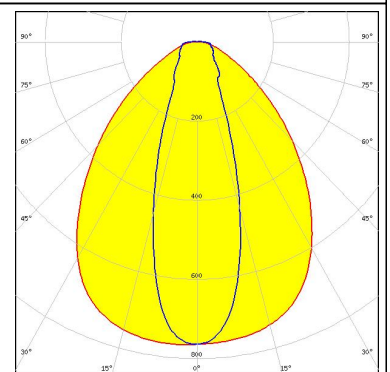
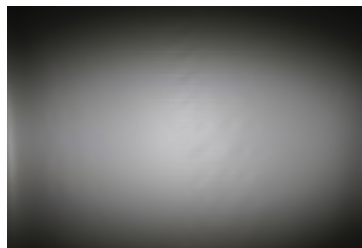

SAMSUNG

LED LT-Q282B
FWHM 86.0 + 33.0°
Efficiency 83 %
Peak intensity 0.800 cd/lm
Required components:

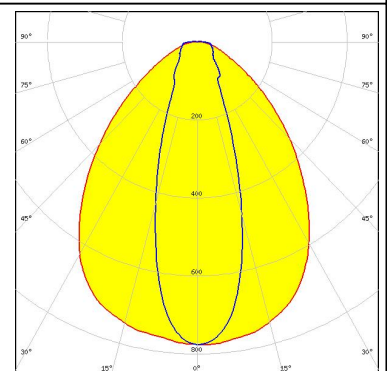
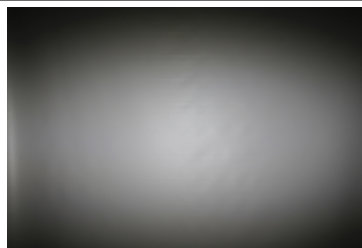

SAMSUNG

LED LT-S282H
FWHM 87.0 + 33.0°
Efficiency 83 %
Peak intensity 0.770 cd/lm
Required components:

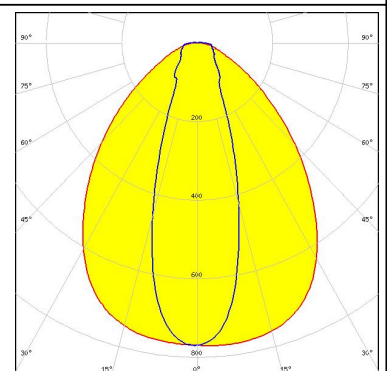
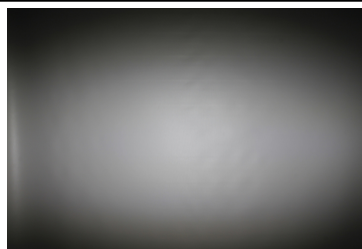

PHOTOMETRIC DATA (MEASURED):

SAMSUNG

LED LT-S562H
FWHM 87.0 + 33.0°
Efficiency 83 %
Peak intensity 0.770 cd/lm
Required components:

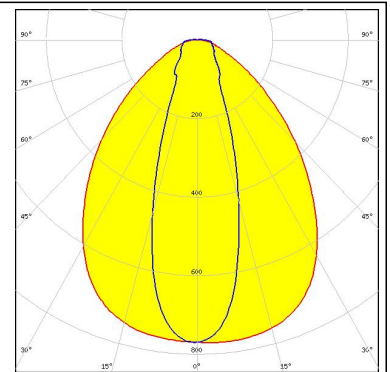
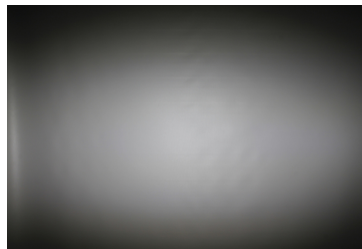

SAMSUNG

LED LT-V282E
FWHM 87.0 + 33.0°
Efficiency 83 %
Peak intensity 0.770 cd/lm
Required components:

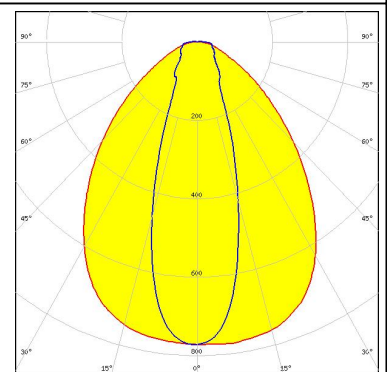
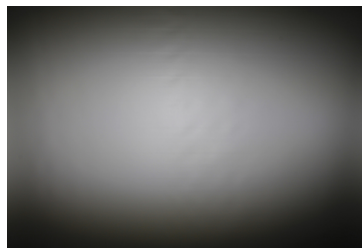

SAMSUNG

LED LT-V562E
FWHM 87.0 + 33.0°
Efficiency 83 %
Peak intensity 0.770 cd/lm
Required components:

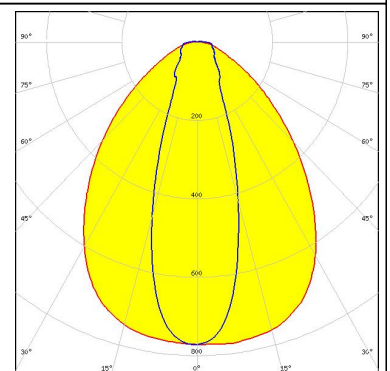
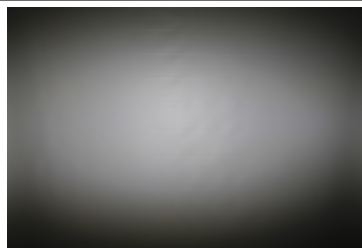

SEOUL SEMICONDUCTOR

LED SunLike 3030
FWHM 89.0 + 37.0°
Efficiency 84 %
Peak intensity 0.740 cd/lm
Required components:

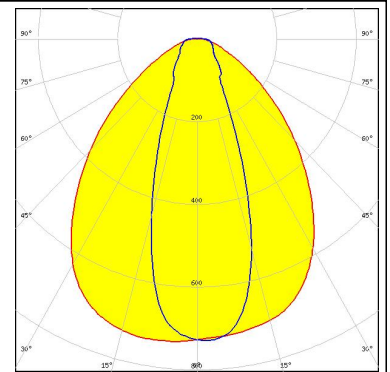
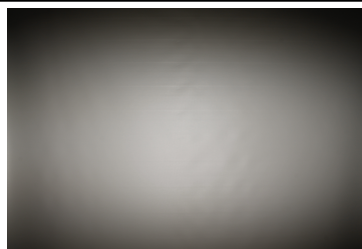

PHOTOMETRIC DATA (MEASURED):

TRIDONIC

LED LLE G4 24x280mm 1250lm
FWHM 89.0 + 38.0°
Efficiency 83 %
Peak intensity 0.720 cd/lm
Required components:

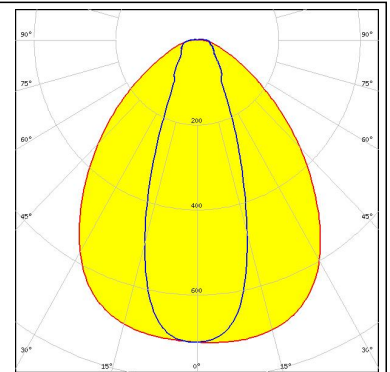

TRIDONIC

LED LLE G4 24x280mm 2000lm ADV
FWHM 88.0 + 40.0°
Efficiency 83 %
Peak intensity 0.690 cd/lm
Required components:

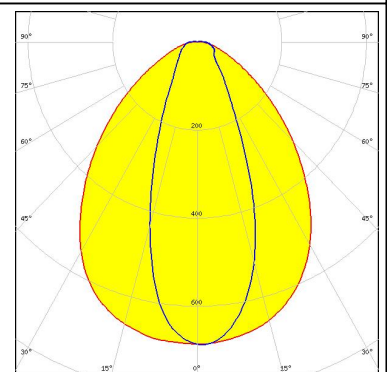
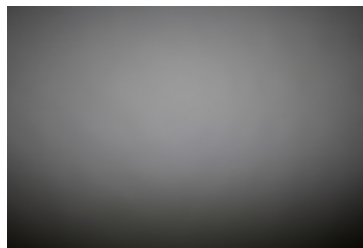

TRIDONIC

LED LLE G4 24x280mm 650lm
FWHM 90.0 + 39.0°
Efficiency 84 %
Peak intensity 0.700 cd/lm
Required components:

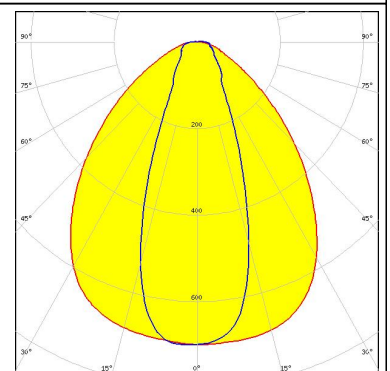
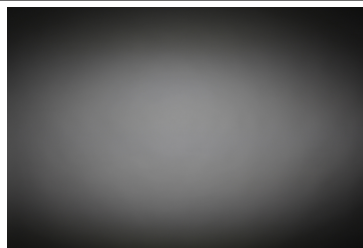

GENERAL INFORMATION:

NOTE: The typical beam angle will be changed by different color, chip size and chip position tolerance. The typical total beam angle is the full angle measured where the luminous intensity is half of the peak value.

MATERIALS:

As part of our continuous research and improvement processes, and to ensure the best possible quality and availability of our products, LEDiL reserves the right to change material grades without notice.

PRODUCT DATA USER AGREEMENT AND DISCLAIMER:

The measured data in the provided downloadable LEDiL Product Datasheets and Mechanical 2D-Drawings is rounded and provided as reference for planning. LEDiL Oy's optical specifications have been verified by conducting performance testing of the products in accordance with the company's quality system. The reported data are averaged results of multiple measurements with typical variation. LEDiL Oy reserves the right to without prior notification make changes and improvements to its products.

LEDiL Oy assumes neither warranty, nor guarantee nor any other liability of any kind for the contents and correctness of the provided data. The provided data has been generated with highest diligence but the provided data may in reality not represent the complete possible variation range of all intrinsic parameters. Therefore, in certain cases a deviation from the provided data could occur.

LEDiL Oy reserves the right to undertake technical changes of its products without further notification which could lead to changes in the provided data. LEDiL Oy assumes no liability of any kind for the possible deviation from any provided data or any other damage resulting from the usage of the provided data.

The user agrees to this disclaimer and user agreement with the download or usage of the provided files.

LEDiL Oy

Joensuunkatu 13
FI-24240 SALO
Finland

LEDiL Inc.

228 West Page Street
Suite D
Sycamore IL 60178
USA

Local sales and technical support

[www.ledil.com/
where_to_buy](http://www.ledil.com/where_to_buy)

Shipping locations

Salo, Finland
Hong Kong, China

Distribution Partners

[www.ledil.com/
where_to_buy](http://www.ledil.com/where_to_buy)