



Chipsmall Limited consists of a professional team with an average of over 10 year of expertise in the distribution of electronic components. Based in Hongkong, we have already established firm and mutual-benefit business relationships with customers from,Europe,America and south Asia,supplying obsolete and hard-to-find components to meet their specific needs.

With the principle of "Quality Parts,Customers Priority,Honest Operation,and Considerate Service",our business mainly focus on the distribution of electronic components. Line cards we deal with include Microchip,ALPS,ROHM,Xilinx,Pulse,ON,Everlight and Freescale. Main products comprise IC,Modules,Potentiometer,IC Socket,Relay,Connector.Our parts cover such applications as commercial,industrial, and automotives areas.

We are looking forward to setting up business relationship with you and hope to provide you with the best service and solution. Let us make a better world for our industry!



## Contact us

Tel: +86-755-8981 8866 Fax: +86-755-8427 6832

Email & Skype: info@chipsmall.com Web: www.chipsmall.com

Address: A1208, Overseas Decoration Building, #122 Zhenhua RD., Futian, Shenzhen, China



## Interference Suppression Film Capacitor - Class X2 Radial MKP 310 V<sub>AC</sub> - Standard Across the Line

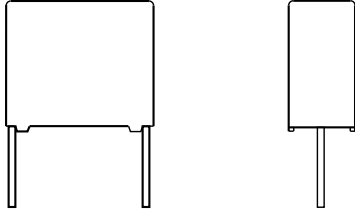

**FEATURES**

- 7.5 mm to 27.5 mm lead pitch
- Self-healing properties
- For temperature up to 110 °C
- Material categorization: for definitions of compliance please see [www.vishay.com/doc?99912](http://www.vishay.com/doc?99912)

**RoHS  
COMPLIANT**
**APPLICATIONS**

For standard across the line X2 applications.

 See also application note: [www.vishay.com/doc?28153](http://www.vishay.com/doc?28153)

QUICK REFERENCE DATA	
Capacitance range (E12 series)	0.001 µF to 4.7 µF (preferred values acc. to E6)
Capacitance tolerance	± 20 %; ± 10 %; (± 5 % on request)
Rated AC voltage	310 V <sub>AC</sub> ; 50 Hz to 60 Hz
Permissible DC voltage	800 V <sub>DC</sub> at 85 °C 630 V <sub>DC</sub> at 110 °C
Climatic testing class according to IEC 60068-1	55 / 110 / 56 / B for volumes > 1750 mm <sup>3</sup> 55 / 110 / 56 / C for volumes ≤ 1750 mm <sup>3</sup>
Maximum application temperature	C ≤ 470 nF: 110 °C (125 °C for less than 1000 h) C > 470 nF: 110 °C
Reference standards	IEC 60384-14 ed-4 (2013) and EN 60384-14 IEC 60065, pass. flamm. class B for volumes > 1750 mm <sup>3</sup> CSA-E384-14; CQC UL 60384-14
Dielectric	Polypropylene film
Electrodes	Metallized film
Construction	Mono construction 
Encapsulation	Plastic case, epoxy resin sealed, flame retardant class UL 94 V-0
Leads	Tinned wire
Marking	C-value; tolerance; rated voltage; sub-class; manufacturer's type; code for dielectric material; manufacturer location, year and week; manufacturer's logo or name; safety approvals

**Notes**

- For more detailed data and test requirements, contact [rfi@vishay.com](mailto:rfi@vishay.com)

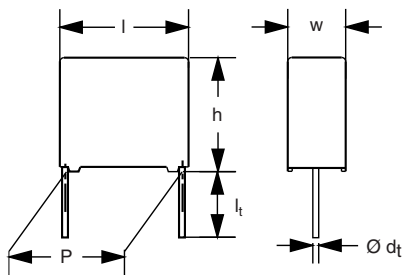
DIMENSIONS in millimeters

**COMPOSITION OF CATALOG NUMBER**

The new RFI Film Capacitor Code is made up 14 digit code (example)

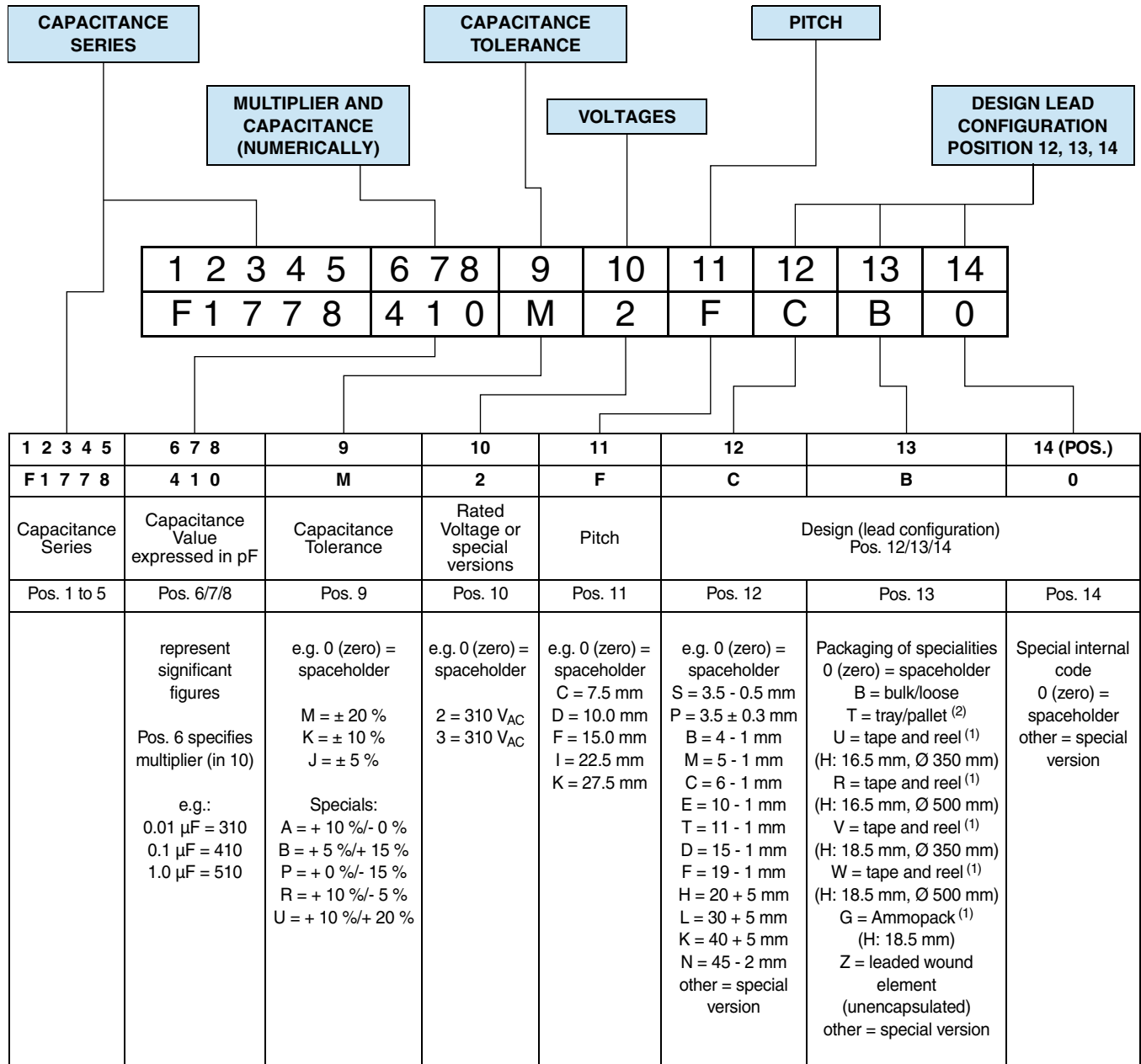
**Notes**

- (1) For detailed tape specification refer to packaging information: [www.vishay.com/doc?28139](http://www.vishay.com/doc?28139)
- (2) Packaging will be bulk for all capacitors with pitch ≤ 15 mm and such with long leads (> 5 mm). Capacitors with short leads up to 5 mm and pitch > 15 mm will be in tray and asking code will be "T".





SPECIFIC REFERENCE DATA		
DESCRIPTION	VALUE	
Rated AC voltage ( $U_{RAC}$ )	310 V	
Permissible DC voltage ( $U_{RDC}$ )	630 V	
Tangent of loss angle:	at 1 kHz	at 10 kHz
$C < 470 \text{ nF}$	$\leq 10 \times 10^{-4}$	$\leq 20 \times 10^{-4}$
$470 \text{ nF} \leq C \leq 1 \mu\text{F}$	$\leq 20 \times 10^{-4}$	$\leq 70 \times 10^{-4}$
$C > 1 \mu\text{F}$	$\leq 30 \times 10^{-4}$	-
Rated voltage pulse slope ( $dU/dt$ ) <sub>R</sub> at 435 V <sub>DC</sub>	600 V/ $\mu\text{s}$	
Pitch = 7.5 mm	600 V/ $\mu\text{s}$	
Pitch = 10 mm	400 V/ $\mu\text{s}$	
Pitch = 15 mm	150 V/ $\mu\text{s}$	
Pitch = 22.5 mm	100 V/ $\mu\text{s}$	
Pitch = 27.5 mm	> 15 000 M $\Omega$	
R between leads, for $C \leq 0.33 \mu\text{F}$ at 100 V; 1 min	> 5000 s	
RC between leads, for $C > 0.33 \mu\text{F}$ at 100 V; 1 min	> 30 000 M $\Omega$	
R between leads and case; 100 V; 1 min	2200 V; 1 min	
Withstanding (DC) voltage (cut off current 10 mA) <sup>(1)</sup> ; rise time $1000 \leq V/s$ :	1800 V; 1 min	
$C \leq 1 \mu\text{F}$	2120 V; 1 min	
$C > 1 \mu\text{F}$	2120 V; 1 min	
Withstanding (AC) voltage between leads and case	110 °C (125 °C less than 1000 h)	
Max. application temperature for $0.001 \mu\text{F} \leq C \leq 0.47 \mu\text{F}$	110 °C	
Max. application temperature for $C > 0.47 \mu\text{F}$	110 °C	

Note

<sup>(1)</sup> See "Voltage Proof Test for Metallized Film Capacitors": [www.vishay.com/doc?28169](http://www.vishay.com/doc?28169)

ELECTRICAL DATA AND ORDERING CODE											
$U_{RAC}$ (V)	CAP. $\mu\text{F}$ POS. 6 TO 8	TOLERANCE CODE POS. 9 J = $\pm 5\%$ K = $\pm 10\%$ M = $\pm 20\%$	DIMENSIONS MAX. w x h x l (mm)	MASS (g) <sup>(3)</sup>	SPQ <sup>(4)</sup> SHORT LEADS (PIECES)	ORDERING CODE <sup>(2)</sup>					
						TYPE	C-VALUE	TOL.	VOLTAGE	PITCH	LEAD LENGTH DESIGN
						1 TO 5	6 TO 8	9	10	11	12 TO 14 <sup>(1)</sup>
310	PITCH 7.5 mm $\pm$ 0.4 mm; $d_t = 0.50 \text{ mm} \pm 0.05 \text{ mm}$										
	0.0010	K / M	4.0 x 9.0 x 10.0	0.45	1500	F1778	210	.	.	C	..0
	0.0012	K	4.0 x 9.0 x 10.0	0.45	1500	F1778	212	K	.	C	..0
	0.0015	K / M	4.0 x 9.0 x 10.0	0.45	1500	F1778	215	.	.	C	..0
	0.0018	K	4.0 x 9.0 x 10.0	0.45	1500	F1778	218	K	.	C	..0
	0.0022	K / M	4.0 x 9.0 x 10.0	0.45	1500	F1778	222	.	.	C	..0
	0.0027	K	4.0 x 9.0 x 10.0	0.45	1500	F1778	227	K	.	C	..0
	0.0033	K / M	4.0 x 9.0 x 10.0	0.45	1500	F1778	233	.	.	C	..0
	0.0039	K	4.0 x 9.0 x 10.0	0.45	1500	F1778	239	K	.	C	..0
	0.0047	K / M	4.0 x 9.0 x 10.0	0.45	1500	F1778	247	.	.	C	..0
	0.0056	K	4.0 x 9.0 x 10.0	0.45	1500	F1778	256	K	.	C	..0
	0.0068	K / M	4.0 x 9.0 x 10.0	0.45	1500	F1778	268	.	.	C	..0
	0.0082	K	4.0 x 9.0 x 10.0	0.45	1500	F1778	282	K	.	C	..0
	0.010	K / M	4.0 x 9.0 x 10.0	0.45	1500	F1778	310	.	.	C	..0
	0.012	K	4.0 x 9.0 x 10.0	0.45	1500	F1778	312	K	.	C	..0
	0.015	K / M	4.0 x 9.0 x 10.0	0.45	1500	F1778	315	.	.	C	..0
	0.018	K	4.0 x 9.0 x 10.0	0.45	1500	F1778	318	K	.	C	..0
	0.022	K / M	4.0 x 9.0 x 10.0	0.45	1500	F1778	322	.	.	C	..0
	0.027	K	4.0 x 9.0 x 10.0	0.45	1500	F1778	327	K	.	C	..0
	0.033	K	5.0 x 10.5 x 10.0	0.6	1000	F1778	333	K	.	C	..0
0.033	M	4.0 x 9.0 x 10.0	0.45	1500	F1778	333	M	.	C	..0	
0.039	K	5.0 x 10.5 x 10.0	0.6	1000	F1778	339	K	.	C	..0	
0.047	K	5.0 x 10.5 x 10.0	0.6	1000	F1778	347	K	.	C	..0	
0.047	M	5.0 x 10.5 x 10.0	0.4	1000	F1778	347	M	.	C	..0	
0.056	K	6.0 x 11.5 x 10.0	0.8	750	F1778	356	K	.	C	..0	
0.068	M	6.0 x 11.5 x 10.0	0.8	750	F1778	368	M	.	C	..0	





ELECTRICAL DATA AND ORDERING CODE												
U <sub>RAC</sub> (V)	CAP. μF POS. 6 TO 8	TOLERANCE CODE POS. 9 J = ± 5 % K = ± 10 % M = ± 20 %	DIMENSIONS MAX. w x h x l (mm)	MASS (g) <sup>(3)</sup>	SPQ <sup>(4)</sup> SHORT LEADS (PIECES)	ORDERING CODE <sup>(2)</sup>						
						TYPE	C-VALUE	TOL.	VOLTAGE	PITCH	LEAD LENGTH DESIGN	
						1 TO 5	6 TO 8	9	10	11	12 TO 14 <sup>(1)</sup>	
310	<b>PITCH 10 mm ± 0.4 mm; d<sub>t</sub> = 0.60 mm ± 0.06 mm</b>											
	0.0010	K / M	4.0 x 10.0 x 12.5	0.6	1500	F1778	210	.	.	D	..0	
	0.0012	K	4.0 x 10.0 x 12.5	0.6	1500	F1778	212	K	.	D	..0	
	0.0015	K / M	4.0 x 10.0 x 12.5	0.6	1500	F1778	215	.	.	D	..0	
	0.0018	K	4.0 x 10.0 x 12.5	0.6	1500	F1778	218	K	.	D	..0	
	0.0022	K / M	4.0 x 10.0 x 12.5	0.6	1500	F1778	222	.	.	D	..0	
	0.0027	K	4.0 x 10.0 x 12.5	0.6	1500	F1778	227	K	.	D	..0	
	0.0033	K / M	4.0 x 10.0 x 12.5	0.6	1500	F1778	233	.	.	D	..0	
	0.0039	K	4.0 x 10.0 x 12.5	0.6	1500	F1778	239	K	.	D	..0	
	0.0047	K / M	4.0 x 10.0 x 12.5	0.6	1500	F1778	247	.	.	D	..0	
	0.0056	K	4.0 x 10.0 x 12.5	0.6	1500	F1778	256	K	.	D	..0	
	0.0068	K / M	4.0 x 10.0 x 12.5	0.6	1500	F1778	268	.	.	D	..0	
	0.0082	K	4.0 x 10.0 x 12.5	0.6	1500	F1778	282	K	.	D	..0	
	0.010	K / M	4.0 x 10.0 x 12.5	0.6	1500	F1778	310	.	.	D	..0	
	0.012	K	4.0 x 10.0 x 12.5	0.6	1500	F1778	312	K	.	D	..0	
	0.015	K / M	4.0 x 10.0 x 12.5	0.6	1500	F1778	315	.	.	D	..0	
	0.018	K	4.0 x 10.0 x 12.5	0.6	1250	F1778	318	K	.	D	..0	
	0.022	K / M	4.0 x 10.0 x 12.5	0.6	1250	F1778	322	.	.	D	..0	
	0.027	K	4.0 x 10.0 x 12.5	0.6	1250	F1778	327	K	.	D	..0	
	0.033	K / M	4.0 x 10.0 x 12.5	0.6	1000	F1778	333	.	.	D	..0	
	0.039	K	4.0 x 10.0 x 12.5	0.6	1000	F1778	339	K	.	D	..0	
	0.047	K	4.0 x 10.0 x 12.5	0.6	750	F1778	347	K	.	D	..0	
	0.047	M	4.0 x 10.0 x 12.5	0.6	1000	F1778	347	M	.	D	..0	
	0.056	K	5.0 x 11.0 x 12.5	0.82	1000	F1778	356	K	.	D	..0	
	0.068	K / M	5.0 x 11.0 x 12.5	0.82	750	F1778	368	.	.	D	..0	
	0.082	K	6.0 x 12.0 x 12.5	1.10	750	F1778	382	K	.	D	..0	
	0.100	K / M	6.0 x 12.0 x 12.5	1.10	750	F1778	410	.	.	D	..0	
	<b>PITCH 15 mm ± 0.4 mm; d<sub>t</sub> = 0.60 mm ± 0.06 mm</b>											
	0.010	K / M	5.0 x 11.0 x 17.5	1.0	750	F1778	310	.	.	F	..0	
	0.012	K	5.0 x 11.0 x 17.5	1.0	750	F1778	312	K	.	F	..0	
	0.015	K / M	5.0 x 11.0 x 17.5	1.0	750	F1778	315	.	.	F	..0	
	0.018	K	5.0 x 11.0 x 17.5	1.0	750	F1778	318	K	.	F	..0	
	0.022	K / M	5.0 x 11.0 x 17.5	1.0	750	F1778	322	.	.	F	..0	
	0.027	K	5.0 x 11.0 x 17.5	1.0	750	F1778	327	K	.	F	..0	
	0.033	K / M	5.0 x 11.0 x 17.5	1.0	750	F1778	333	.	.	F	..0	
	0.039	K	5.0 x 11.0 x 17.5	1.0	750	F1778	339	K	.	F	..0	
	0.047	K / M	5.0 x 11.0 x 17.5	1.0	750	F1778	347	.	.	F	..0	
	0.056	K	5.0 x 11.0 x 17.5	1.0	750	F1778	356	K	.	F	..0	
	0.068	K / M	5.0 x 11.0 x 17.5	1.0	750	F1778	368	.	.	F	..0	
	0.082	K	5.0 x 11.0 x 17.5	1.0	750	F1778	382	K	.	F	..0	
	0.10	K	5.0 x 11.0 x 17.5	1.0	600	F1778	410	K	.	F	..0	
	0.10	M	5.0 x 11.0 x 17.5	1.0	750	F1778	410	M	.	F	..0	
	0.12	K	6.0 x 12.0 x 17.5	1.4	600	F1778	412	K	.	F	..0	
	0.15	K	6.0 x 12.0 x 17.5	1.4	450	F1778	415	K	.	F	..0	
	0.15	M	6.0 x 12.0 x 17.5	1.4	600	F1778	415	M	.	F	..0	
	<b>PITCH 15 mm ± 0.4 mm; d<sub>t</sub> = 0.80 mm ± 0.08 mm</b>											
	0.18	K	7.0 x 13.5 x 17.5	1.8	450	F1778	418	K	.	F	..0	
	0.22	K / M	7.0 x 13.5 x 17.5	1.8	300	F1778	422	.	.	F	..0	
0.27	K	8.5 x 15.0 x 17.5	2.4	240	F1778	427	K	.	F	..0		
0.33	K / M	8.5 x 15.0 x 17.5	2.4	240	F1778	433	.	.	F	..0		
0.39	K	10.0 x 16.5 x 17.5	3	225	F1778	439	K	.	F	..0		
0.47	K / M	10.0 x 16.5 x 17.5	3	225	F1778	447	.	.	F	..0		
0.56	K / M	10.0 x 18.5 x 18.0	4.3	225	F1778	456	.	.	F	..0		
0.68	M	11.0 x 18.5 x 18.0	5.5	225	F1778	468	M	.	F	..0		



ELECTRICAL DATA AND ORDERING CODE												
U <sub>RAC</sub> (V)	CAP. μF POS. 6 TO 8	TOLERANCE CODE POS. 9 J = ± 5 % K = ± 10 % M = ± 20 %	DIMENSIONS MAX. w x h x l (mm)	MASS (g) <sup>(3)</sup>	SPQ <sup>(4)</sup> SHORT LEADS (PIECES)	ORDERING CODE <sup>(2)</sup>						
						TYPE	C-VALUE	TOL.	VOLTAGE	PITCH	LEAD LENGTH DESIGN	
						1 TO 5	6 TO 8	9	10	11	12 TO 14 <sup>(1)</sup>	
<b>PITCH 22.5 mm ± 0.4 mm; d<sub>t</sub> = 0.80 mm ± 0.08 mm</b>												
310	0.12	K	6.0 x 15.5 x 26.0	2.4	260	F1778	412	K	.	I	..0	
	0.15	K / M	6.0 x 15.5 x 26.0	2.4	260	F1778	415	.	.	I	..0	
	0.18	K	6.0 x 15.5 x 26.0	2.4	260	F1778	418	K	.	I	..0	
	0.22	K / M	6.0 x 15.5 x 26.0	2.4	260	F1778	422	.	.	I	..0	
	0.27	K	6.0 x 15.5 x 26.0	2.4	200	F1778	427	K	.	I	..0	
	0.33	K	6.0 x 15.5 x 26.0	2.4	190	F1778	433	K	.	I	..0	
	0.33	M	6.0 x 15.5 x 26.0	2.4	235	F1778	433	M	.	I	..0	
	0.39	K	7.0 x 16.5 x 26.0	2.9	200	F1778	439	K	.	I	..0	
	0.47	K	7.0 x 16.5 x 26.0	2.9	190	F1778	447	K	.	I	..0	
	0.47	M	7.0 x 16.5 x 26.0	2.9	200	F1778	447	M	.	I	..0	
	0.56	K	8.5 x 18.0 x 26.0	3.8	150	F1778	456	K	.	I	..0	
	0.68	K	10.0 x 19.5 x 26.0	6.8	150	F1778	468	K	.	I	..0	
	0.68	M	8.5 x 18.0 x 26.0	3.8	170	F1778	468	M	.	I	..0	
	0.82	K	10.0 x 19.5 x 26.0	6.8	200	F1778	482	K	.	I	..0	
	1.0	K	12.0 x 22.0 x 26.0	7.8	150	F1778	510	K	.	I	..0	
	1.0	M	10.0 x 19.5 x 26.0	6.8	135	F1778	510	M	.	I	..0	
	1.5	M	12.5 x 22.5 x 26.5	10	140	F1778	515	M	.	I	..0	
	<b>PITCH 27.5 mm ± 0.4 mm; d<sub>t</sub> = 0.80 mm ± 0.08 mm</b>											
		0.47	K / M	9.0 x 19.0 x 31.5	5.5	160	F1778	447	.	.	K	..0
		0.56	K	9.0 x 19.0 x 31.5	5.5	160	F1778	456	K	.	K	..0
	0.68	K / M	9.0 x 19.0 x 31.5	5.5	160	F1778	468	.	.	K	..0	
	0.82	K	11.0 x 21.0 x 31.0	7.4	125	F1778	482	K	.	K	..0	
	1.0	K / M	11.0 x 21.0 x 31.0	7.4	125	F1778	510	.	.	K	..0	
	1.2	K	11.0 x 21.0 x 31.0	7.4	110	F1778	512	K	.	K	..0	
	1.5	K / M	13.0 x 23.0 x 31.0	9.2	110	F1778	515	.	.	K	..0	
	1.8	K	15.0 x 25.0 x 31.5	12.3	85	F1778	518	K	.	K	..0	
	2.2	K / M	15.0 x 25.0 x 31.5	12.3	85	F1778	522	.	.	K	..0	
	2.7	K	18.0 x 28.0 x 31.5	16.1	100	F1778	527	K	.	K	..0	
	3.3	K	21.0 x 31.0 x 31.0	20.3	70	F1778	533	K	.	K	..0	
	3.3	M	18.0 x 28.0 x 31.5	16.1	80	F1778	533	M	.	K	..0	
	3.9	K	21.0 x 31.0 x 31.0	20.3	50	F1778	539	K	.	K	..0	
	4.7	M	21.0 x 31.0 x 31.0	20.3	50	F1778	547	M	.	K	..0	

**Notes**

- SPQ = Standard Packing Quantity
- For detailed tape specifications refer to packaging information: [www.vishay.com/doc?28139](http://www.vishay.com/doc?28139)
- (1) For further packaging see table "Composition of Catalog Number"
- (2) Further information about packaging quantities with different lead length and / or taped versions, see document "Packing Quantities" [www.vishay.com/doc?27608](http://www.vishay.com/doc?27608)
- (3) Weight for short lead product only

APPROVALS				
SAFETY APPROVALS X2	VOLTAGE	VALUE	FILE NUMBERS	LINKS
EN 60384-14 (ENEC) (= IEC 60384-14 ed-4 (2013))	310 V <sub>AC</sub>	1 nF to 4.7 μF	FI 2016052	<a href="http://www.vishay.com/doc?28179">www.vishay.com/doc?28179</a>
UL 60384-14	310 V <sub>AC</sub>	1 nF to 4.7 μF	E354331	<a href="http://www.vishay.com/doc?28184">www.vishay.com/doc?28184</a>
CSA-E384-14	310 V <sub>AC</sub>	1 nF to 4.7 μF	E354331	
CQC	310 V <sub>AC</sub>	1 nF to 4.7 μF	CQC08001026060 (F) CQC08001026061 (L)	
CB test certificate	310 V <sub>AC</sub>	1 nF to 4.7 μF	FI 9369	<a href="http://www.vishay.com/doc?28175">www.vishay.com/doc?28175</a>
The ENEC-approval together with the CB-certificate replace all national marks of the following countries (they have already signed the ENEC-agreement): Austria; Belgium; Czech Republic; Denmark; Finland; France; Germany; Greece; Hungary; Ireland; Italy; Luxembourg; Netherlands; Norway; Portugal; Slovenian; Spain; Sweden; Switzerland and United Kingdom.				
  				

## MOUNTING

### Normal Use

The capacitors are designed for mounting on printed-circuit boards. The capacitors packed in bandoliers are designed for mounting in printed circuit boards by means of automatic insertion machines.

For detailed tape specifications refer to Packaging Information: [www.vishay.com/doc?28139](http://www.vishay.com/doc?28139)

### Specific Method of Mounting to Withstand Vibration and Shock

In order to withstand vibration and shock tests, it must be ensured that the stand-off pips are in good contact with the printed-circuit board:

- For pitches  $\leq 15$  mm capacitors shall be mechanically fixed by the leads
- For larger pitches the capacitors shall be mounted in the same way and the body clamped in addition

### Space Requirements on Printed Circuit-Board

The maximum space for length ( $l_{max.}$ ), width ( $w_{max.}$ ), and height ( $h_{max.}$ ) of film capacitors to take in account on the printed circuit board is shown in the drawings:

- For products with pitch  $\leq 15$  mm,  $\Delta w \times \Delta l = 0.3$  mm and  $\Delta h = 0.1$  mm
- For products with  $15$  mm  $<$  pitch  $\leq 27.5$  mm,  $\Delta w \times \Delta l = 0.5$  mm and  $\Delta h = 0.1$  mm
- For products with pitch = 37.5 mm,  $\Delta w \times \Delta l = 0.7$  mm and  $\Delta h = 0.5$  mm

Eccentricity defined as in drawing. The maximum eccentricity is smaller than or equal to the lead diameter of the product concerned.

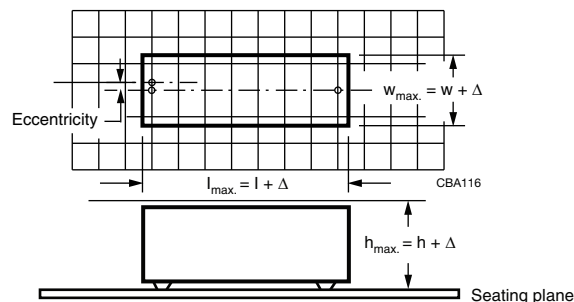



### SOLDERING CONDITIONS

For general soldering conditions and wave soldering profile, we refer to the application note: "Soldering Guideline for Film Capacitors": [www.vishay.com/doc?28171](http://www.vishay.com/doc?28171)

### Storage Temperature

T<sub>stg</sub> = -25 °C to +35 °C with RH maximum 75 % without condensation

### Ratings and Characteristics Reference Conditions

Unless otherwise specified, all electrical values apply to an ambient free air temperature of 23 °C ± 1 °C, an atmospheric pressure of 86 kPa to 106 kPa and a relative humidity of 50 % ± 2 %.

For reference testing, a conditioning period shall be applied over 96 h ± 4 h by heating the products in a circulating air oven at the rated temperature and a relative humidity not exceeding 20 %.

### CHARACTERISTICS

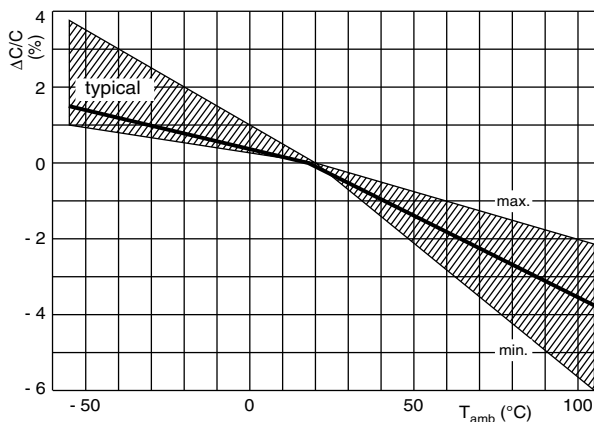

Capacitance as a function of ambient temperature (typical curve)

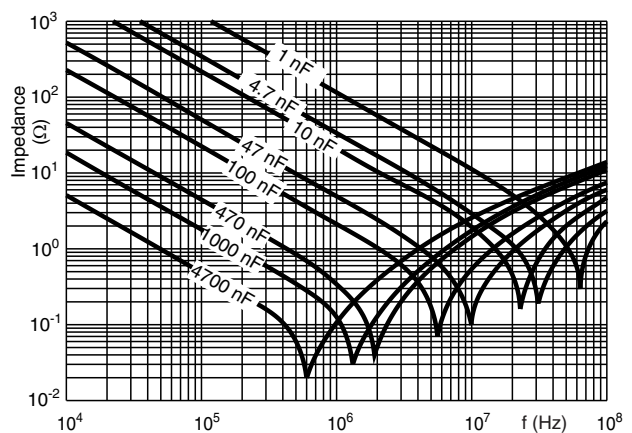

Impedance as a function of frequency (typical curve)

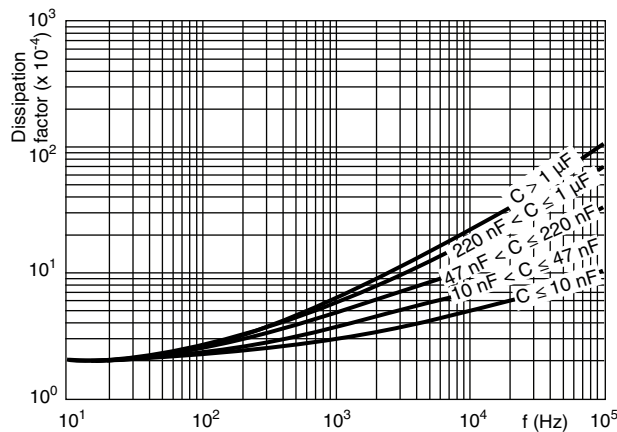

Tangent of loss angle as a function of frequency (typical curve)

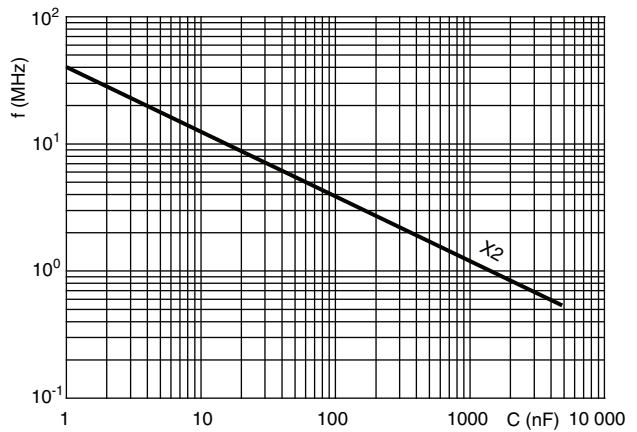

Resonant frequency as a function of capacitance (typical curve)



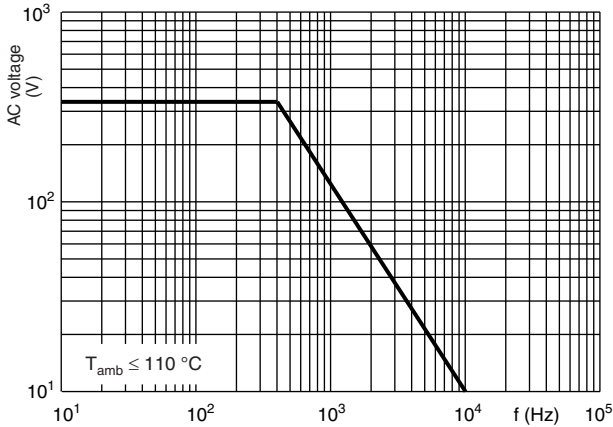

Max. RMS voltage as a function of frequency (typical curve)

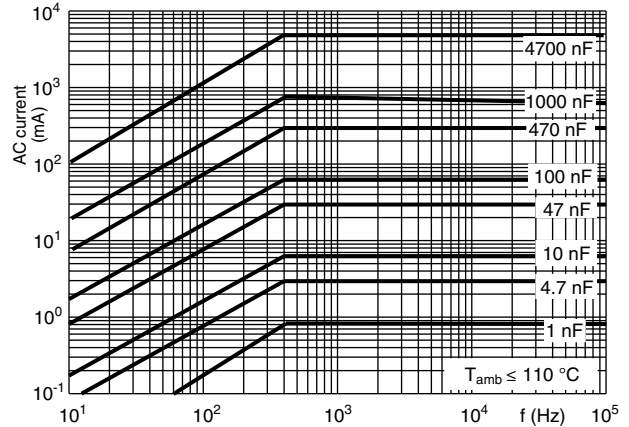

Max. RMS current as a function of frequency (typical curve)

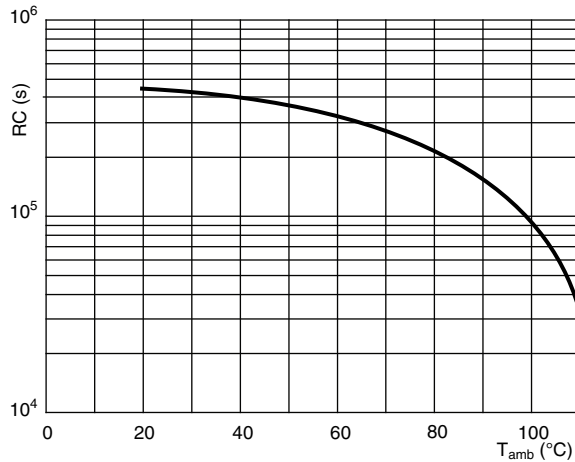

Insulation resistance as a function of ambient temperature (typical curve)

**APPLICATION NOTES**

- For X2 electromagnetic interference suppression in **standard across the line applications** (50 Hz / 60 Hz) with a maximum mains voltage of 310 V<sub>AC</sub>.
- For series impedance applications we refer to application note [www.vishay.com/doc?28153](http://www.vishay.com/doc?28153)
- For capacitors connected in parallel, normally the proof voltage and possibly the rated voltage must be reduced. For information depending of the capacitance value and the number of parallel connections contact: [rfi@vishay.com](mailto:rfi@vishay.com)
- These capacitors are not intended for continuous pulse applications. For these situations, capacitors of the AC and pulse programs must be used.
- The maximum ambient temperature must not exceed 110 °C (125 °C for less than 1000 h) for C ≤ 470 nF and 110 °C for C > 470 nF.
- Rated voltage pulse slope:  
if the pulse voltage is lower than the rated voltage, the values of the specific reference data can be multiplied by 435 V<sub>DC</sub> and divided by the applied voltage.



**INSPECTION REQUIREMENTS**

**General Notes**

Sub-clause numbers of tests and performance requirements refer to the “Sectional Specification, IEC Publication IEC 60384-14 ed-4 (2013) and Specific Reference Data”.

<b>GROUP C INSPECTION REQUIREMENTS</b>		
<b>SUB-CLAUSE NUMBER AND TEST</b>	<b>CONDITIONS</b>	<b>PERFORMANCE REQUIREMENTS</b>
<b>SUB-GROUP C1A PART OF SAMPLE OF SUB-GROUP C1</b>		
4.1 Dimensions (detail)		As specified in section “General Data” of this specification
Initial measurements	Capacitance Tangent of loss angle: for C ≤ 1 μF at 10 kHz for C > 1 μF at 1 kHz	
4.3 Robustness of terminations	Tensile: load 10 N; 10 s Bending: load 5 N; 4 x 90°	No visible damage
4.4 Resistance to soldering heat	No pre-drying Method: 1A Solder bath: 280 °C ± 5 °C Duration: 10 s	
4.19 Component solvent resistance	Isopropylalcohol at room temperature Method: 2 Immersion time: 5 min ± 0.5 min Recovery time: min. 1 h, max. 2 h	
4.4.2 Final measurements	Visual examination	No visible damage Legible marking
	Capacitance	ΔC/C  ≤ 5 % of the value measured initially.
	Tangent of loss angle	Increase of tan δ: ≤ 0.008 for: C ≤ 1 μF or ≤ 0.005 for: C > 1 μF Compared to values measured initially.
	Insulation resistance	As specified in section “Insulation Resistance” of this specification
<b>SUB-GROUP C1B PART OF SAMPLE OF SUB-GROUP C1</b>		
Initial measurements	Capacitance Tangent of loss angle: for C ≤ 1 μF at 10 kHz for C > 1 μF at 1 kHz	
4.20 Solvent resistance of the marking	Isopropylalcohol at room temperature Method: 1 Rubbing material: cotton wool Immersion time: 5 min ± 0.5 min	No visible damage Legible marking
4.6 Rapid change of temperature	θA = -55 °C θB = +110 °C 5 cycles Duration t = 30 min	
4.6.1 Inspection	Visual examination	No visible damage
4.7 Vibration	Mounting: see section “Mounting” of this specification Procedure B4 Frequency range: 10 Hz to 55 Hz Amplitude: 0.75 mm or Acceleration 98 m/s <sup>2</sup> (whichever is less severe) Total duration 6 h	



<b>GROUP C INSPECTION REQUIREMENTS</b>		
<b>SUB-CLAUSE NUMBER AND TEST</b>	<b>CONDITIONS</b>	<b>PERFORMANCE REQUIREMENTS</b>
<b>SUB-GROUP C1B PART OF SAMPLE OF SUB-GROUP C1</b>		
4.7.2 Final inspection	Visual examination	No visible damage
4.9 Shock	Mounting: see section "Mounting" for more information Pulse shape: half sine Acceleration: 490 m/s <sup>2</sup> Duration of pulse: 11 ms	
4.9.2 Final measurements	Visual examination  Capacitance  Tangent of loss angle  Insulation resistance	No visible damage  $ \Delta C/C  \leq 5\%$ of the value measured initially.  Increase of $\tan \delta$ : $\leq 0.008$ for: $C \leq 1 \mu\text{F}$ or $\leq 0.005$ for: $C > 1 \mu\text{F}$ Compared to values measured initially.  As specified in section "Insulation Resistance" of this specification
<b>SUB-GROUP C1 COMBINED SAMPLE OF SPECIMENS OF SUB-GROUPS C1A AND C1B</b>		
4.11 Climatic sequence		
4.11.1 Initial measurements	Capacitance measured in 4.4.2 and 4.9.2 Tangent of loss angle: measured initially in C1A and C1B	
4.11.2 Dry heat	Temperature: 110 °C	
4.11.3 Damp heat cyclic Test Db First cycle	Duration: 16 h	
4.11.4 Cold	Temperature: -55 °C	
4.11.5 Damp heat cyclic Test Db Remaining cycles	Duration: 2 h	
4.11.6 Final measurements	Visual examination  Capacitance  Tangent of loss angle  Voltage proof 1350 V <sub>DC</sub> ; 1 min between terminations  Insulation resistance	No visible damage Legible marking  $ \Delta C/C  \leq 5\%$ of the value measured in 4.11.1.  Increase of $\tan \delta$ : $\leq 0.008$ for: $C \leq 1 \mu\text{F}$ or $\leq 0.005$ for: $C > 1 \mu\text{F}$ Compared to values measured in 4.11.1.  No permanent breakdown or flash-over  $\geq 50\%$ of values specified in section "Insulation Resistance" of this specification
<b>SUB GROUP C2</b>		
4.12 Damp heat steady state	56 days; 40 °C; 90 % to 95 % RH no load	
4.12.1 Initial measurements	Capacitance Tangent of loss angle: at 1 kHz	
4.12.3 Final measurements	Visual examination  Capacitance	No visible damage Legible marking  $ \Delta C/C  \leq 5\%$ of the value measured in 4.12.1.

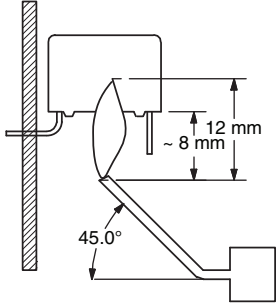

GROUP C INSPECTION REQUIREMENTS		
SUB-CLAUSE NUMBER AND TEST	CONDITIONS	PERFORMANCE REQUIREMENTS
<b>SUB GROUP C2</b>		
4.12.3 Final measurements	Tangent of loss angle  Voltage proof 1350 V <sub>DC</sub> ; 1 min between terminations  Insulation resistance	Increase of tan δ: ≤ 0.008 for: C ≤ 1 μF or ≤ 0.005 for: C > 1 μF Compared to values measured in 4.12.1.  No permanent breakdown or flash-over  ≥ 50 % of values specified in section "Insulation Resistance" of this specification
<b>SUB-GROUP C3</b>		
4.13.1 Initial measurements	Capacitance Tangent of loss angle: for C ≤ 1 μF at 10 kHz for C > 1 μF at 1 kHz	
4.13 Impulse voltage	3 successive impulses, full wave, peak voltage: X2: 2.5 kV for C ≤ 1 μF X2: 2.5 kV/√C for C > 1 μF Max. 24 pulses	No self healing, breakdowns or flash-over
4.14 Endurance	Duration: 1000 h 1.25 x U <sub>RAC</sub> at 110 °C Once in every hour the voltage is increased to 1000 V <sub>RMS</sub> for 0.1 s via resistor of 47 Ω ± 5 %	
4.14.7 Final measurements	Visual examination  Capacitance  Tangent of loss angle  Voltage proof 1350 V <sub>DC</sub> ; 1 min between terminations 2120 V <sub>AC</sub> ; 1 min between terminations and case  Insulation resistance	No visible damage Legible marking   ΔC/C  ≤ 10 % compared to values measured in 4.13.1.  Increase of tan δ: ≤ 0.008 for: C ≤ 1 μF or ≤ 0.005 for: C > 1 μF Compared to values measured in 4.13.1.  No permanent breakdown or flash-over  ≥ 50 % of values specified in section "Insulation Resistance" of this specification
<b>SUB-GROUP C4</b>		
4.15 Charge and discharge	10 000 cycles Charged to 435 V <sub>DC</sub> Discharge resistance: $R = \frac{435 V_{DC}}{1.25 \times C (dU/dt)}$	
4.15.1 Initial measurements	Capacitance Tangent of loss angle: for C ≤ 1 μF at 10 kHz for C > 1 μF at 1 kHz	
4.15.3 Final measurements	Capacitance  Tangent of loss angle  Insulation resistance	ΔC/C  ≤ 10 % compared to values measured in 4.15.1.  Increase of tan δ: ≤ 0.008 for: C ≤ 1 μF or ≤ 0.005 for: C > 1 μF Compared to values measured in 4.15.1.  ≥ 50 % of values specified in section "Insulation Resistance" of this specification

<b>GROUP C INSPECTION REQUIREMENTS</b>		
<b>SUB-CLAUSE NUMBER AND TEST</b>	<b>CONDITIONS</b>	<b>PERFORMANCE REQUIREMENTS</b>
<b>SUB-GROUP C5</b>		
4.16 Radio frequency characteristic	Resonance frequency	≥ 0.9 times the value as specified in section "Resonant Frequency" of this specification.
<b>SUB-GROUP C6</b>		
4.17 Passive flammability Class B	Bore of gas jet: Ø 0.5 mm Fuel: butane Test duration for actual volume V in mm <sup>3</sup> : V ≤ 250: 10 s 250 < V ≤ 500: 20 s 500 < V ≤ 1750: 30 s V > 1750: 60 s One flame application 	After removing test flame from capacitor, the capacitor must not continue to burn for more than 10 s. No burning particle must drop from the sample.
<b>SUB-GROUP C7</b>		
4.18 Active flammability	20 cycles of 2.5 kV discharges on the test capacitor connected to U <sub>RAC</sub> .	The cheese cloth around the capacitors shall not burn with a flame. No electrical measurements are required.





## **Disclaimer**

ALL PRODUCT, PRODUCT SPECIFICATIONS AND DATA ARE SUBJECT TO CHANGE WITHOUT NOTICE TO IMPROVE RELIABILITY, FUNCTION OR DESIGN OR OTHERWISE.

Vishay Intertechnology, Inc., its affiliates, agents, and employees, and all persons acting on its or their behalf (collectively, "Vishay"), disclaim any and all liability for any errors, inaccuracies or incompleteness contained in any datasheet or in any other disclosure relating to any product.

Vishay makes no warranty, representation or guarantee regarding the suitability of the products for any particular purpose or the continuing production of any product. To the maximum extent permitted by applicable law, Vishay disclaims (i) any and all liability arising out of the application or use of any product, (ii) any and all liability, including without limitation special, consequential or incidental damages, and (iii) any and all implied warranties, including warranties of fitness for particular purpose, non-infringement and merchantability.

Statements regarding the suitability of products for certain types of applications are based on Vishay's knowledge of typical requirements that are often placed on Vishay products in generic applications. Such statements are not binding statements about the suitability of products for a particular application. It is the customer's responsibility to validate that a particular product with the properties described in the product specification is suitable for use in a particular application. Parameters provided in datasheets and / or specifications may vary in different applications and performance may vary over time. All operating parameters, including typical parameters, must be validated for each customer application by the customer's technical experts. Product specifications do not expand or otherwise modify Vishay's terms and conditions of purchase, including but not limited to the warranty expressed therein.

Except as expressly indicated in writing, Vishay products are not designed for use in medical, life-saving, or life-sustaining applications or for any other application in which the failure of the Vishay product could result in personal injury or death. Customers using or selling Vishay products not expressly indicated for use in such applications do so at their own risk. Please contact authorized Vishay personnel to obtain written terms and conditions regarding products designed for such applications.

No license, express or implied, by estoppel or otherwise, to any intellectual property rights is granted by this document or by any conduct of Vishay. Product names and markings noted herein may be trademarks of their respective owners.