



Chipsmall Limited consists of a professional team with an average of over 10 year of expertise in the distribution of electronic components. Based in Hongkong, we have already established firm and mutual-benefit business relationships with customers from,Europe,America and south Asia,supplying obsolete and hard-to-find components to meet their specific needs.

With the principle of "Quality Parts,Customers Priority,Honest Operation,and Considerate Service",our business mainly focus on the distribution of electronic components. Line cards we deal with include Microchip,ALPS,ROHM,Xilinx,Pulse,ON,Everlight and Freescale. Main products comprise IC,Modules,Potentiometer,IC Socket,Relay,Connector.Our parts cover such applications as commercial,industrial, and automotives areas.

We are looking forward to setting up business relationship with you and hope to provide you with the best service and solution. Let us make a better world for our industry!



## Contact us

Tel: +86-755-8981 8866 Fax: +86-755-8427 6832

Email & Skype: info@chipsmall.com Web: www.chipsmall.com

Address: A1208, Overseas Decoration Building, #122 Zhenhua RD., Futian, Shenzhen, China



## GENERAL DESCRIPTION

This document describes the specification for the IDTF1951 Digital Step Attenuator. The F1951 is part of a family of *Glitch-Free™* DSAs optimized for the demanding requirements of communications Infrastructure. These devices are offered in a compact 4x4 QFN package with 50 Ω impedances for ease of integration into the radio system.

## COMPETITIVE ADVANTAGE

Digital step attenuators are used in Receivers and Transmitters to provide gain control. The IDTF1951 is a 6-bit step attenuator optimized for these demanding applications. The silicon design has very low insertion loss and low distortion (+65 dBm IP<sub>3</sub>.) The device has pinpoint accuracy and settles to final attenuation value within 400 nsec. Most importantly, the F1951 includes IDT's *Glitch-Free™* technology which results in less than 0.6 dB of overshoot ringing during MSB transitions. This is in stark contrast to competing DSAs that *glitch as much as 10 dB* during MSB transitions (see p.10)

- ✓ Lowest insertion loss for best SNR
- ✓ Glitch-Free™ when transitioning – won't damage PA or ADC
- ✓ Extremely accurate with low distortion



## APPLICATIONS

- Base Station 2G, 3G, 4G, TDD radiocards
- Repeaters and E911 systems
- Digital Pre-Distortion
- Point to Point Infrastructure
- Public Safety Infrastructure
- WIMAX Receivers and Transmitters
- Military Systems, JTRS radios
- RFID handheld and portable readers
- Cable Infrastructure

## PART# MATRIX

Part#	Freq range	Resolution / Range	Control	IL	Pinout
F1951	100 - 4000	0.50 / 31.5	Serial Only	-1.2	HITT
F1950	150 - 4000	0.25 / 31.5	Serial Only	-1.3	PE
F1952	100 - 4000	0.50 / 15.5	Serial Only	-0.9	HITT

## FEATURES

- *Glitch-Free™*, < 0.6 dB transient overshoot
- Spurious Free Design
- 3V to 5V supply
- Attenuation Error < 0.2 dB @ 2 GHz
- Low Insertion Loss < 1.2 dB @ 2 GHz
- Excellent Linearity +65 dBm IP<sub>3</sub>
- Fast settling time, < 450 nsec
- Class 2 JEDEC ESD (> 2kV HBM)
- Serial Interface 31.5 dB Range
- Stable Integral Non-Linearity over temperature
- 4x4 mm Thin QFN 24 pin package

## DEVICE BLOCK DIAGRAM

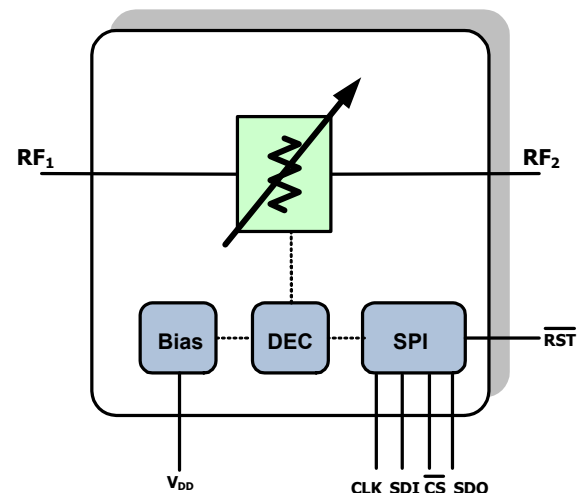

## ORDERING INFORMATION

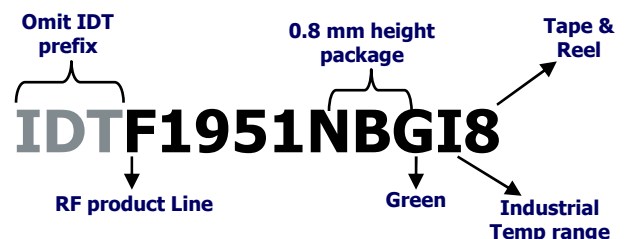

**ABSOLUTE MAXIMUM RATINGS**

$V_{DD}$ to GND	-0.3V to +5.25V
D[5:0], DATA, CLK, CSb, SDO, RSTb	-0.3V to 3.6V
RF Input Power (RF1, RF2) calibration and testing	+29 dBm
RF Input Power (RF1, RF2) continuous RF operation	+23 dBm
$\theta_{JA}$ (Junction – Ambient)	+50°C/W
$\theta_{JC}$ (Junction – Case) The Case is defined as the exposed paddle	+3°C/W
Operating Temperature Range (Case Temperature)	$T_C = -40^{\circ}\text{C}$ to $+100^{\circ}\text{C}$
Maximum Junction Temperature	140°C
Storage Temperature Range	-65°C to +150°C
Lead Temperature (soldering, 10s) .	+260°C

**6-bit 0.5 dB Digital Step Attenuator**
**100 MHz to 4000 MHz**
**IDTF1951 SPECIFICATION (31.5 dB Range)**

 Specifications apply at  $V_{DD} = +3.3V$ ,  $f_{RF} = 2000MHz$ ,  $T_C = +25^{\circ}C$  unless otherwise noted, EVkit losses are de-embedded (see p. 17)

Parameter	Comment	Sym.	min	typical	max	units
Logic Input High	CLK, CSb, DATA, D[5:0], RSTb	$V_{IH}$	<b>2.3</b>		3.6	V
Logic Input Low	CLK, CSb, DATA, D[5:0], RSTb	$V_{IL}$			<b>0.7</b>	V
Logic Current	$V_{MODE}$	$I_{IH}, I_{IL}$	<b>-5</b>		<b>+5</b>	$\mu A$
Supply Voltage(s)	Main Supply	$V_{DD}$		3.0 to 5.25		V
Supply Current	Total	$I_{DD}$		<b>1.1</b>	<b>2<sup>1</sup></b>	mA
Temperature Range	Operating Range (Case)	$T_C$		-40 to +100		degC
Frequency Range	Operating Range	$f_{RF}$		100 to 4000		MHz
RF1, RF2 Return Loss	dB(s11), dB(s22)	$S_{11}, S_{22}$		-22		dB
Minimum Attenuation	D[5:0] = [111111]	$A_{MIN}$ or $I_L$		<b>1.2</b>	<b>1.9</b>	dB
Maximum Attenuation	<ul style="list-style-type: none"> <li>D[5:0] = [000000]</li> <li><math>V_{DD} = 3.3V</math></li> </ul>	$A_{MAX}$	32.2	32.5		dB
Minimum Gain Step	Least Significant Bit	<b>LSB</b>		0.50		dB
Phase Delta	Phase change $A_{MIN}$ vs. $A_{MAX}$	$\Phi_{\Delta}$		33		deg
Differential Non-Linearity	Error: adjacent steps	<b>DNL</b>		0.08		dB
Integral Non-Linearity	Error: absolute to 14 dB ATTN	<b>INL<sub>1</sub></b>		<b>0.03</b>	<b>0.34</b>	dB
Integral Non-Linearity	Max Error vs. line ( $A_{MIN}$ ref) to 31.5 dB ATTN [ $V_{DD} = 3.3V$ ]	<b>INL<sub>2</sub></b>		0.21	0.38	dB
Input IP3	D[5:0] = [111111] = $A_{MIN}$ D[5:0] = [100000] = $A_{15.5}$ D[5:0] = [000000] = $A_{MAX}$ <ul style="list-style-type: none"> <li><math>P_{IN} = +10</math> dBm per tone</li> <li>50 MHz Tone Separation</li> <li><math>V_{DD} = 3.3V</math></li> </ul>	$IP3_{11}$ $IP3_{12}$ $IP3_{13}$	+61 <sup>2</sup> +59 +57	+64 +61 +61		dBm
0.1 dB Compression <i>Please note ABS MAX</i>	<ul style="list-style-type: none"> <li>D[5:0] = [111010] = <math>A_{2.5}</math></li> <li>Baseline <math>P_{IN} = 20</math> dBm</li> </ul>	<b>P<sub>0.1</sub></b>		29		dBm
Settling Time	<ul style="list-style-type: none"> <li>Start LE rising edge &gt; <math>V_{IH}</math></li> <li>End +/-0.10 dB Pout settling</li> <li>15.5 – 16.0 transition</li> </ul>	<b>T<sub>LSB</sub></b>		400		nsec
Serial Clock Speed	SPI 4 wire bus	<b>F<sub>CLK</sub></b>		<b>20</b>	<b>50</b>	MHz
Reset to Serial Setup	SPI 4 wire bus	<b>A</b>	<b>20</b>			nsec
Serial Data Hold Time	SPI 4 wire bus	<b>B</b>	<b>5</b>			nsec
CSb setup delay	SPI 4 wire bus	<b>C</b>	<b>40</b>		<b>100</b>	nsec
Serial Data Out Delay	SPI 4 wire bus	<b>D</b>	<b>8</b>	<b>8</b>	<b>8</b>	Cycles

**SPECIFICATION NOTES:**

 1 – Items in min/max columns in **bold italics** are Guaranteed by Test

2 – All other Items in min/max columns are Guaranteed by Design Characterization

**SERIAL CONTROL MODE**

Data is clocked in LSB first via serial mode. Note the timing diagram below.

An RSTb pulse resets the shift register to [00000000]. If the RSTb pulse is followed immediately by a CSb pulse the device will be set to **Maximum Attenuation**.

**Note** – The IDTF1951 includes a CLK inhibit feature designed to minimize sensitivity to CLK bus noise when the device is not being programmed. When CSb is high ( $> V_{IH}$ ), the CLK input is disabled and serial data (SDI) will not be clocked into the shift register. It is recommended that CSb be pulled high ( $> V_{IH}$ ) when the device is not being programmed

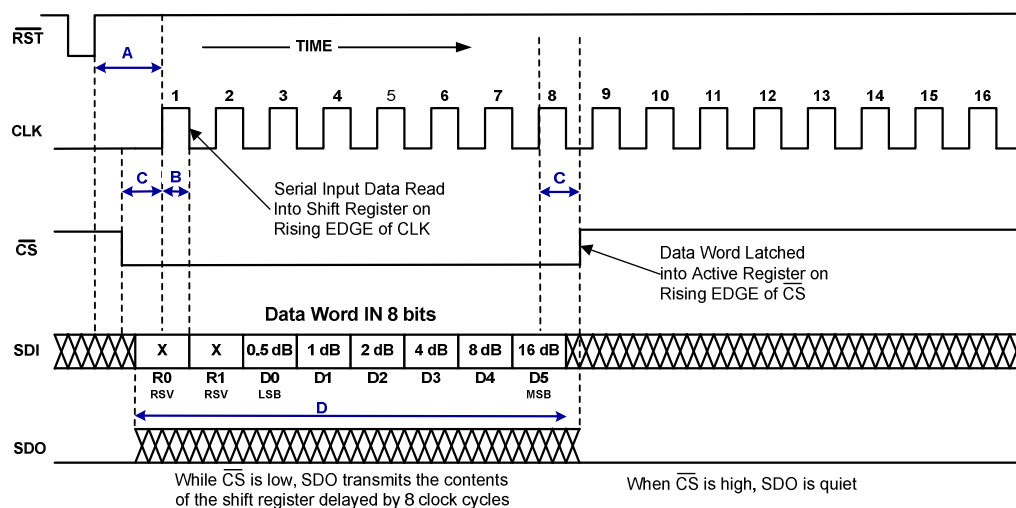
**SERIAL REGISTER TIMING DIAGRAM [SINGLE DEVICE]:** (Note the Timing Spec Intervals in **Blue**)

**SERIAL REGISTER TIMING DIAGRAM [TWO OR MORE DEVICES]:**

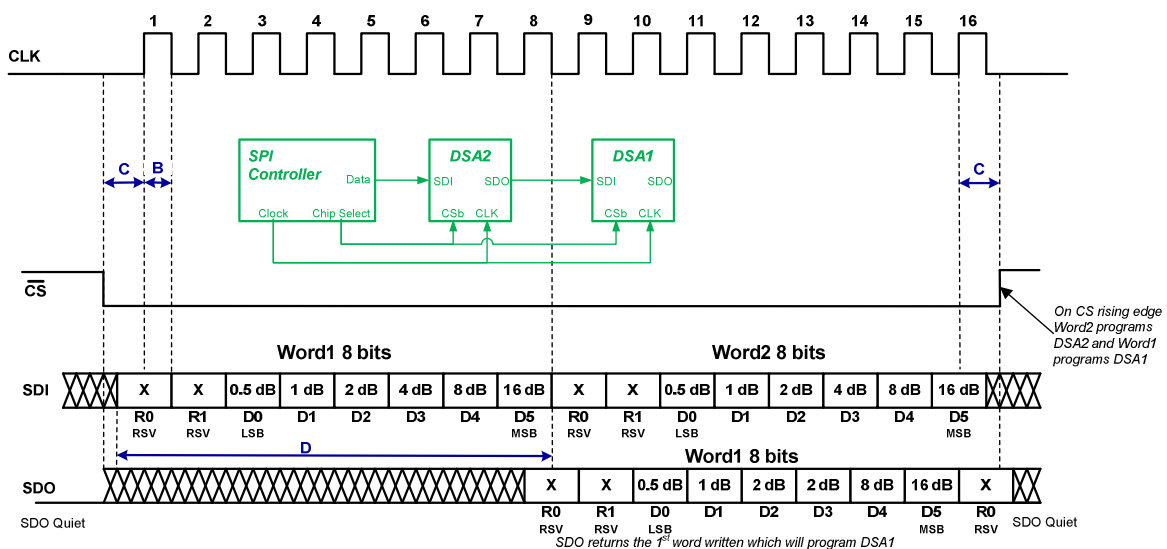
The contents of the shift register is delayed by 8 clock cycles while CSb is low. This feature allows one to program multiple DSAs (in a MIMO transceiver for instance) with a single common CSb line by daisy-chaining the SDO of the 2<sup>nd</sup> DSA to the SDI of the 1<sup>st</sup> DSA and so forth:



**SERIAL REGISTER DEFAULT CONDITION [F1951]:**

When the device is first powered up, it will default to the **Maximum Attenuation** setting as described below:

*Note that for the F1951 (High or 1) = Attenuation Stepped OUT. (0 or Low) = Attenuation Stepped IN.*

**Default Register Settings**

0	0	0	0	0	0	0	0
R0 RSV	R1 RSV	D0 LSB	D1	D2	D3	D4	D5 MSB

**SERIAL REGISTER TIMING TABLE [F1951]:**

Interval Symbol	Description	Min Spec	Max Spec	Units
A	Reset to Serial Setup Time	20		nsec
B	Serial Data Hold Time	5		nsec
C	CSb setup delay	40	100	nsec
D	Serial Data Out Delay	8	8	Cycles

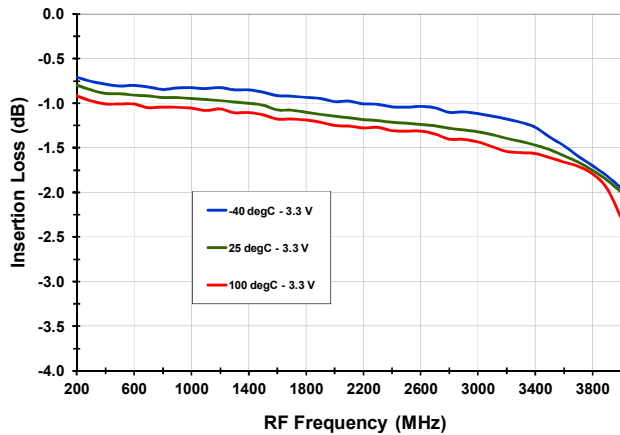
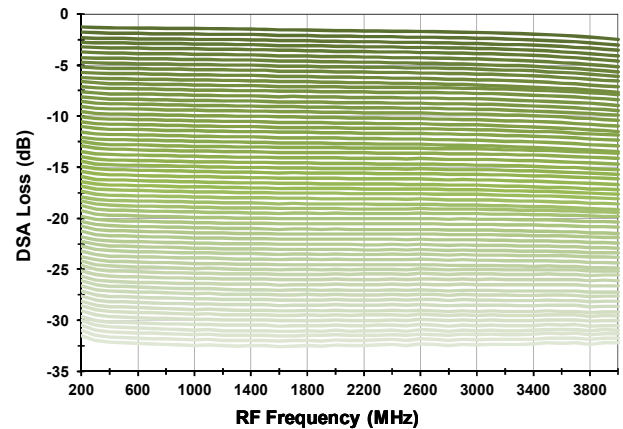
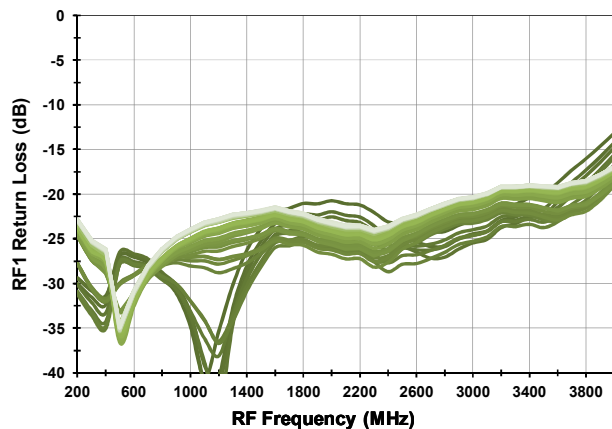
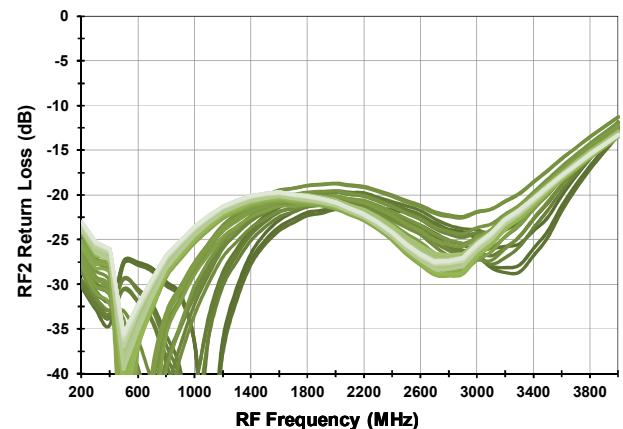
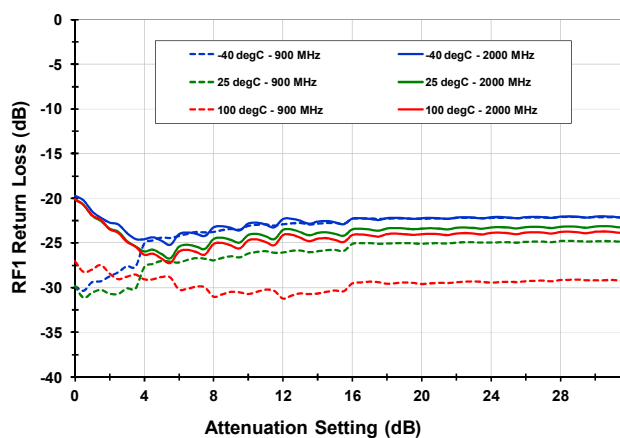
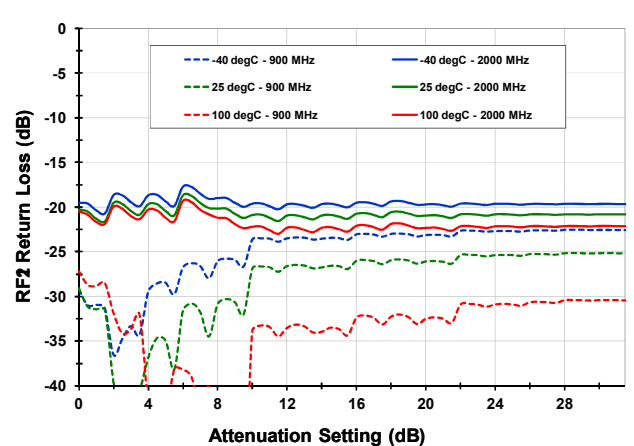
**TYPICAL OPERATING PARAMETRIC CURVES (EVKit loss de-embedded, 3.3V unless otherwise noted)**
**Insertion Loss vs. Frequency [ $A_{MIN}$ ]**

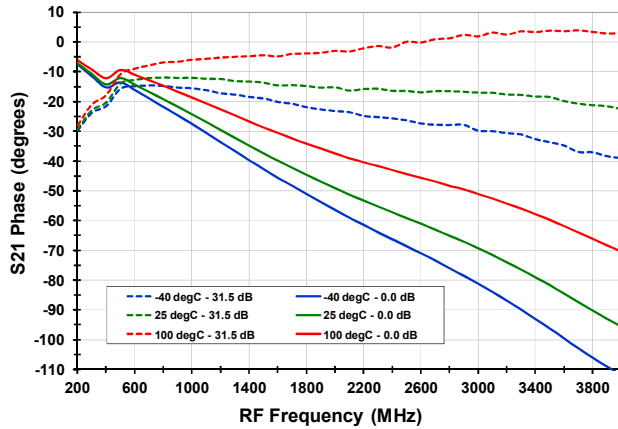
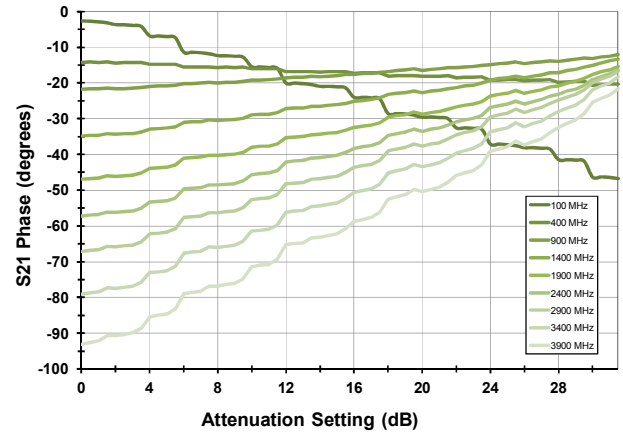
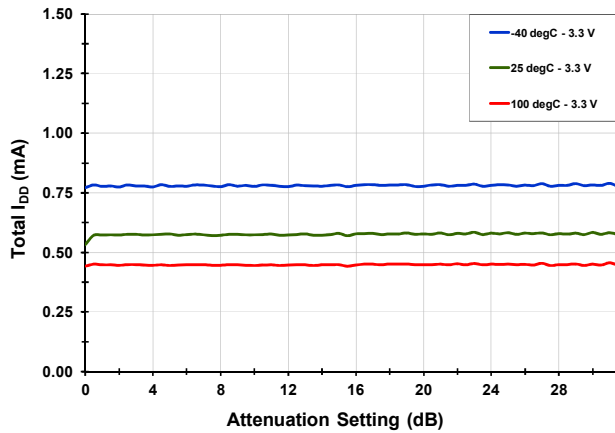
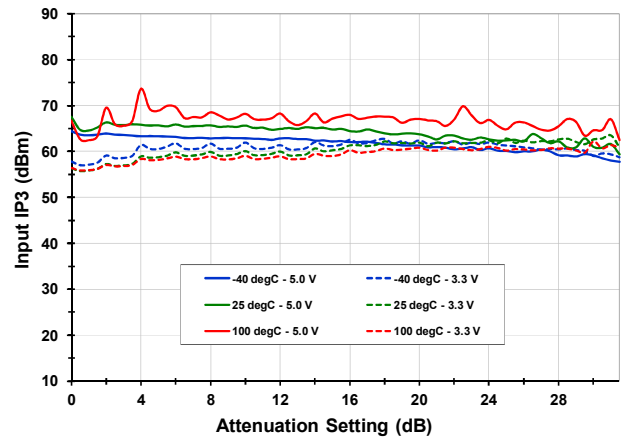
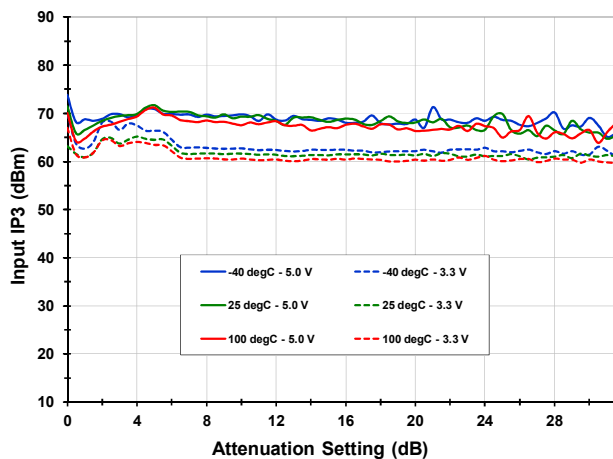
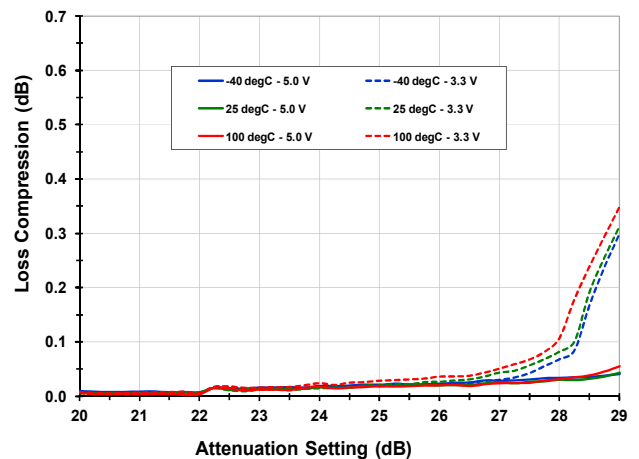
**Attenuation vs. Freq [ $T_{CASE} = +25C, 0.5$  dB steps]**

 **$S_{11}$  vs. Frequency [ $T_{CASE} = +25C, 0.5$  dB steps]**

 **$S_{22}$  vs. Frequency [ $T_{CASE} = +25C, 0.5$  dB steps]**

 **$S_{11}$  vs. Attenuation State**

 **$S_{22}$  vs. Attenuation State**

**TOCS CONTINUED (-2-)**
**Phase vs. Frequency**

**Phase vs. Attenuation Setting**

**Supply Current I<sub>DD</sub>**

**Input IP3 [f<sub>RF</sub> = 900 MHz]**

**Input IP3 [f<sub>RF</sub> = 1900 MHz]**

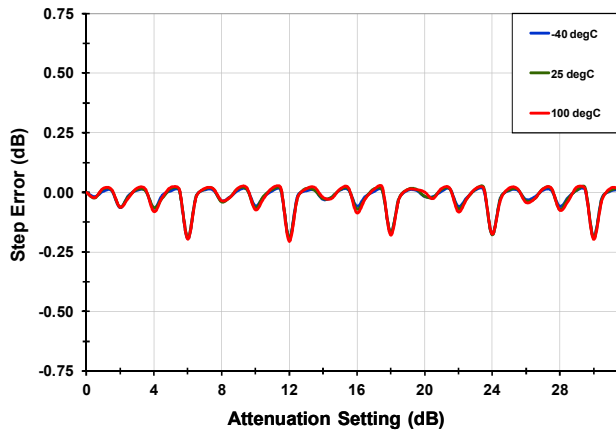
**Compression [f<sub>RF</sub> = 2000 MHz, ATTN = 2.5 dB]**





**TOCS CONTINUED (-3-)**

**DNL [150 MHz]**



**DNL [400 MHz]**

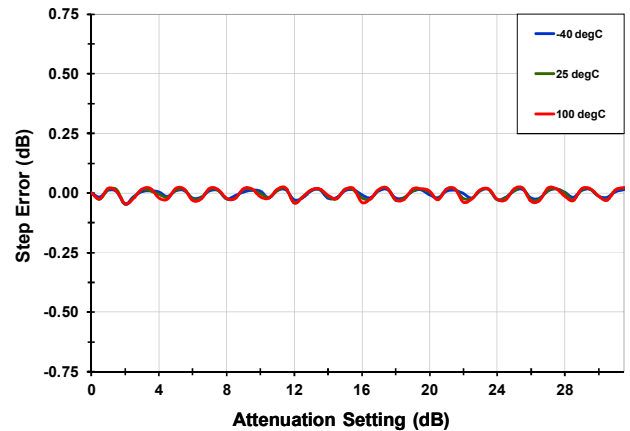

**DNL [900 MHz]**

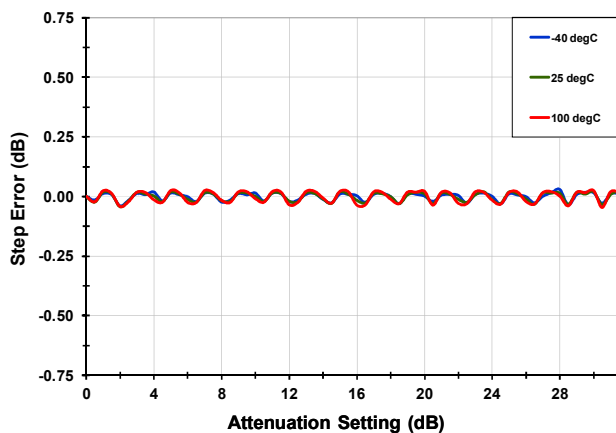

**DNL [1900 MHz]**

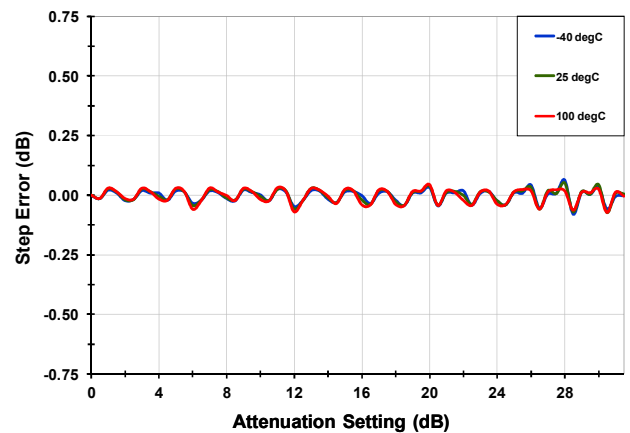

**DNL [2800 MHz]**

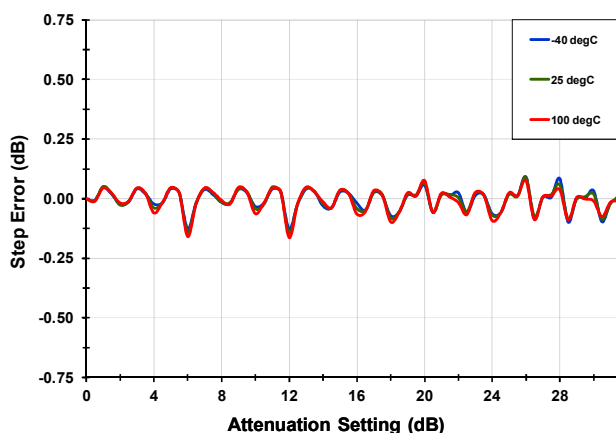

**Worst Setting DNL**

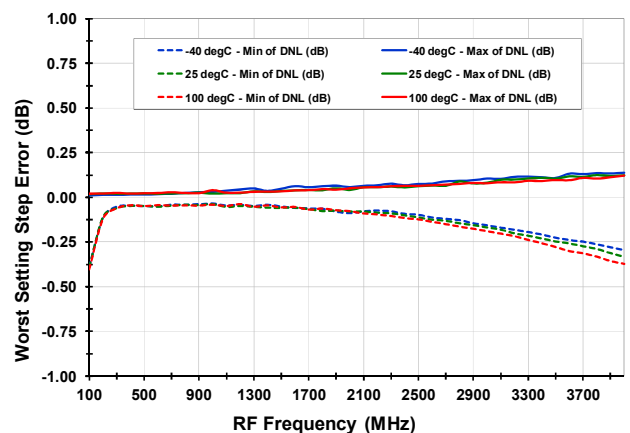

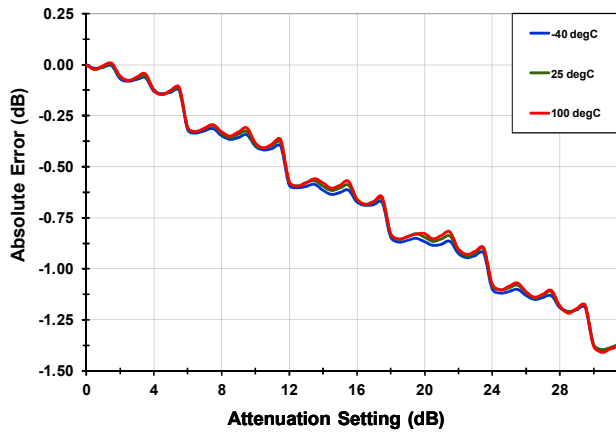
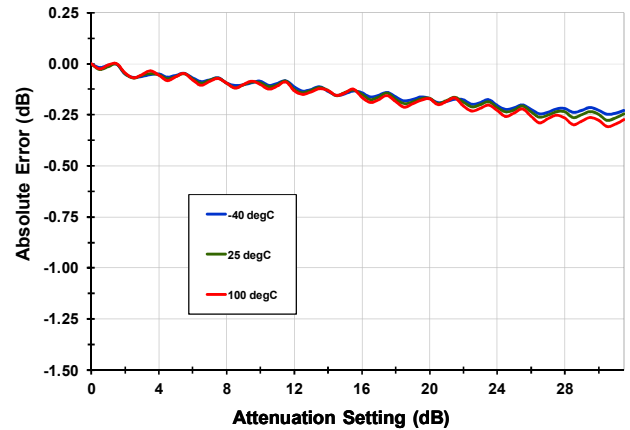
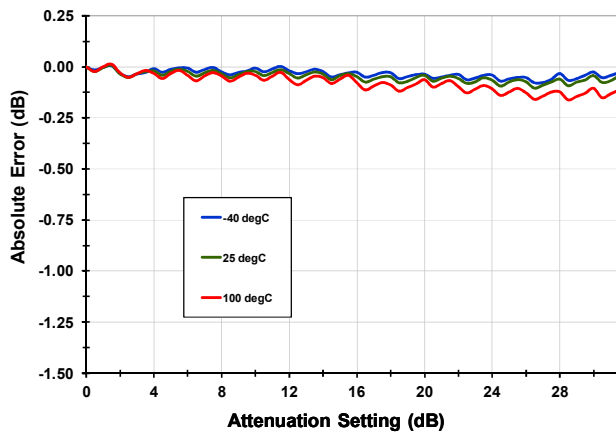
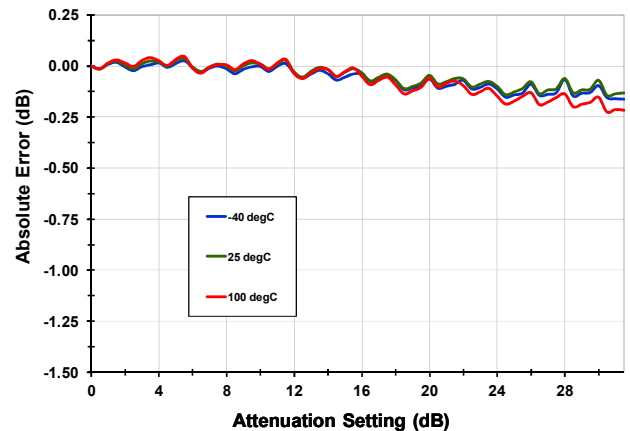
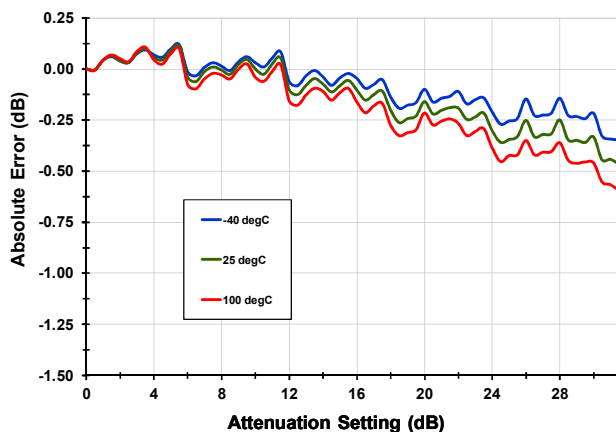
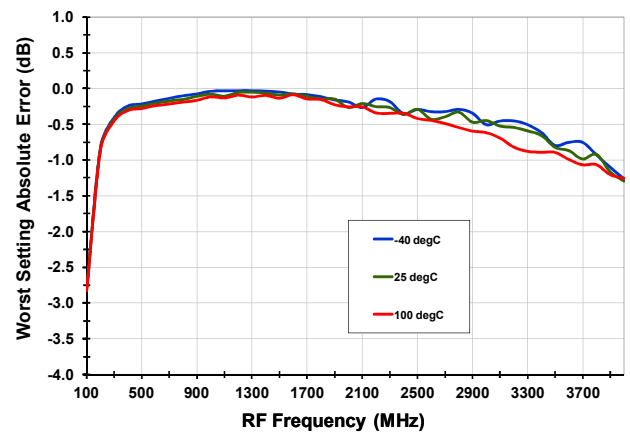
**TOCS CONTINUED (-4-)**
**INL [150 MHz]**

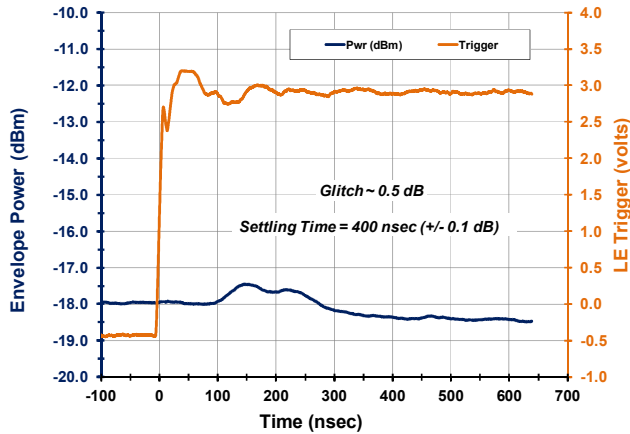
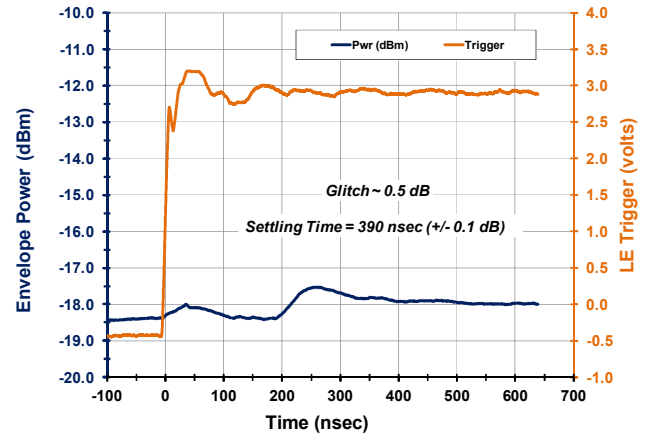
**INL [400 MHz]**

**INL [900 MHz]**

**INL [1900 MHz]**

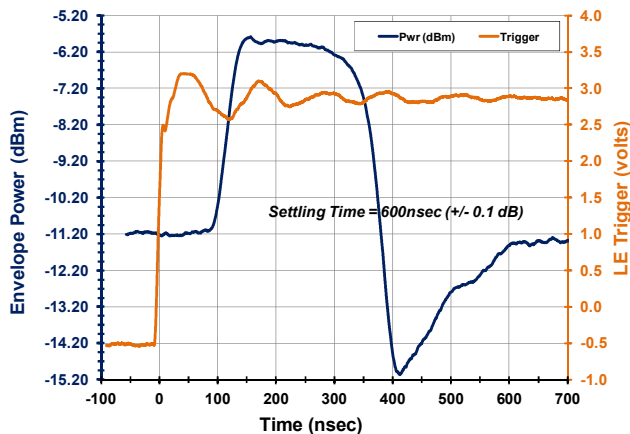
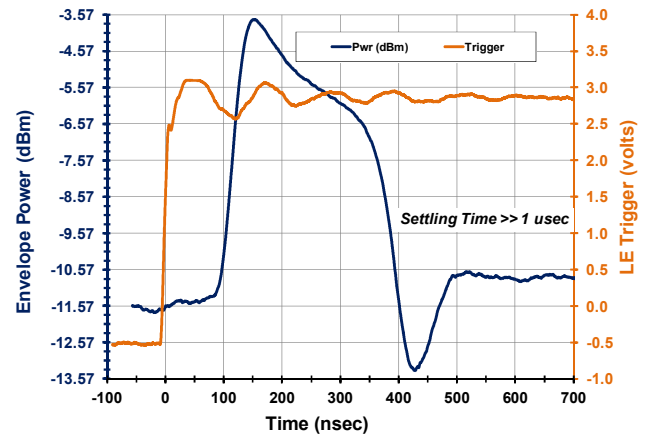
**INL [2900 MHz]**

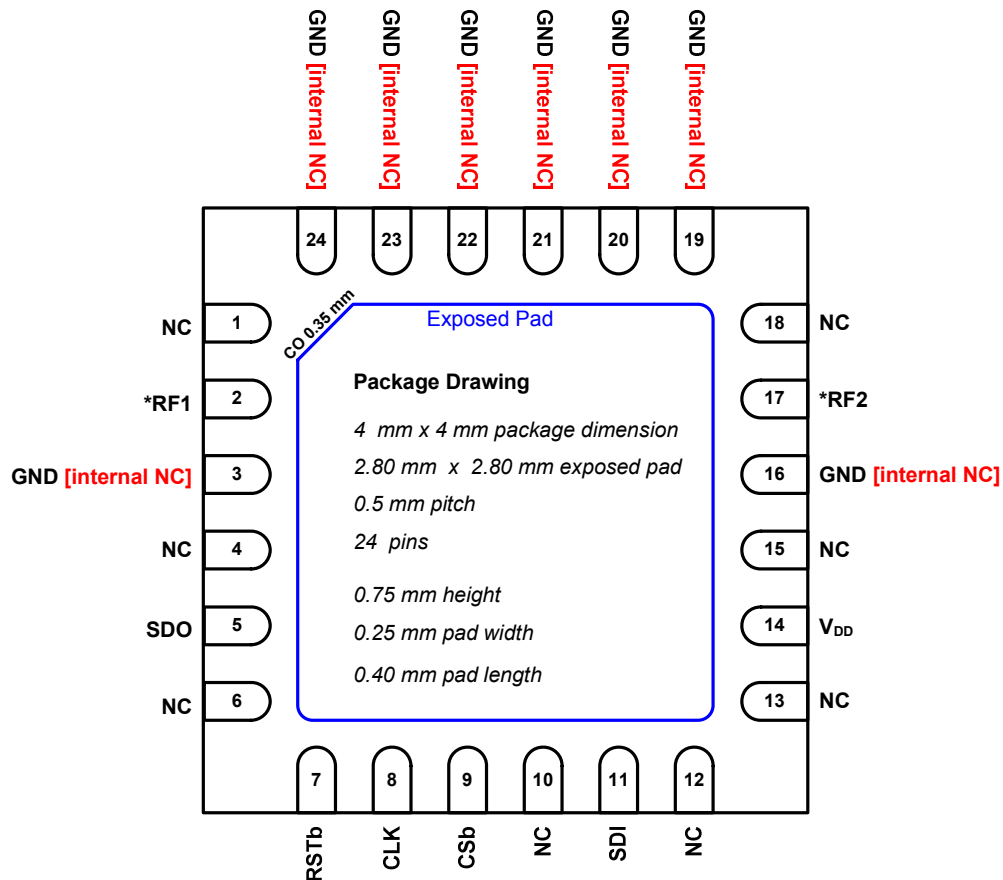
**Worst Setting INL**

**TOCS CONTINUED (-5-) [ $f_{RF} = 900$  MHz]**
**Transient [ 15.5 to 16.0 (MSB+) 3.3V F1951 ]**

**Transient [ 16.0 to 15.5 (MSB-) 5.0V F1951 ]**

The graphs ABOVE show the transient overshoot and settling time performance for both the MSB+ and MSB- cases for the F1951. The device settles very quickly ( $\sim 400$ ) nsec with benign ( $\sim 0.5$ ) dB overshoot.

The graphs BELOW show the transient overshoot and settling time performance for a popular competing DSA. *Note the overshoot/undershoot excursion of almost 10 dB and the very long settling time.* For the MSB- case, the settling time is off the scale,  $\sim 3$  usec.

**Transient [ 15.75 to 16.00 (MSB+) Standard DSA ]**

**Transient [ 16.00 to 15.75 (MSB-) Standard DSA ]**

**PIN DIAGRAM (F1951)**
**TOP View**
*(looking through the top of the package)*



**6-bit 0.5 dB Digital Step Attenuator**

**100 MHz to 4000 MHz**

**PACKAGE DRAWING (4X4 24 PIN)**

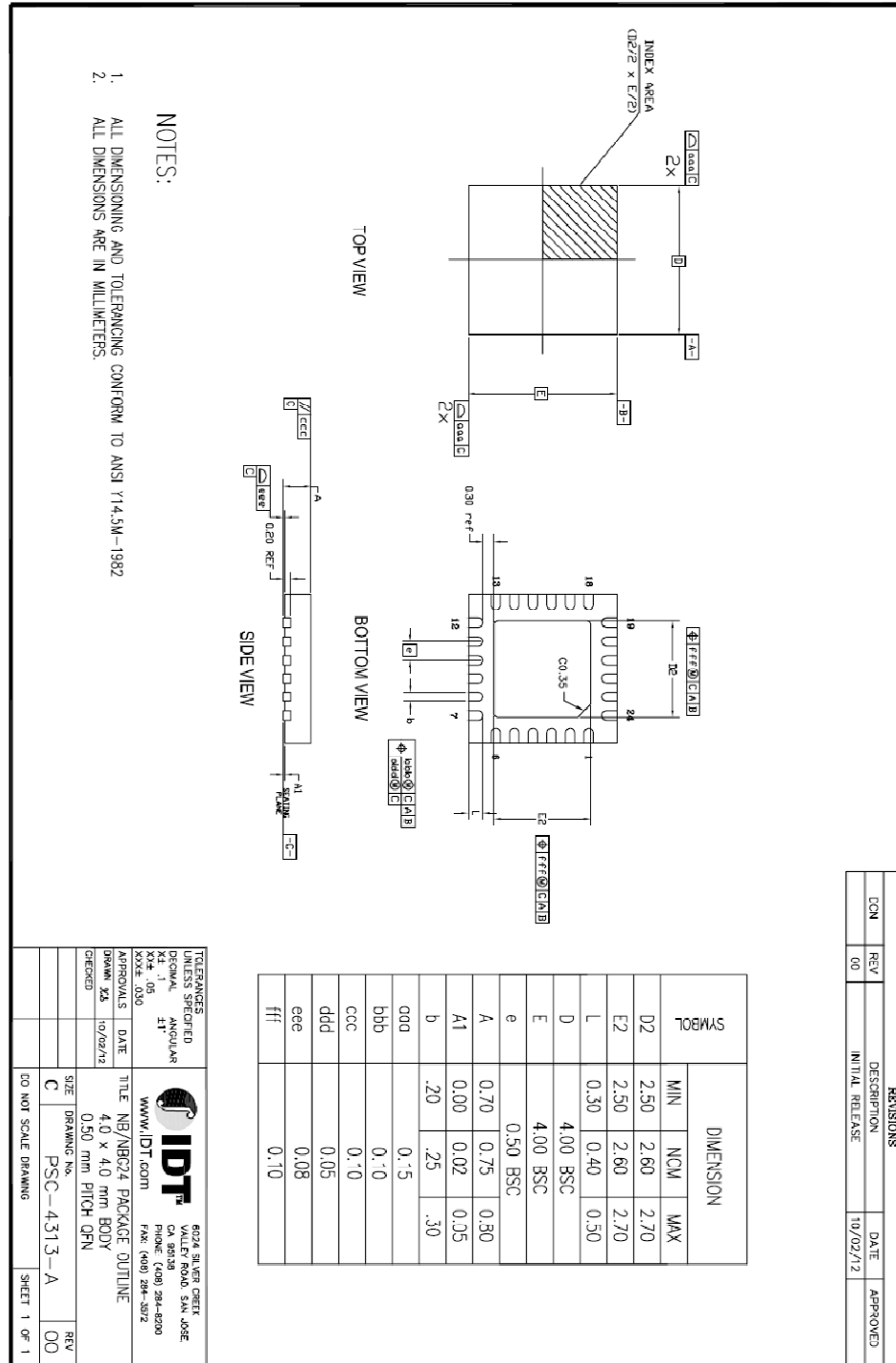

**PIN DESCRIPTIONS**

Pin #	Pin Name	Pin Function
1	NC	Internally unconnected. Recommended connection is GND.
2	RF1	Device RF input or output (bi-directional). Must AC couple to this pin.
3	GND	Connect directly to paddle ground or as close as possible to pin with thru via.
4	NC	Internally unconnected. Recommended connection is GND.
5	SDO	Serial Data Out...Delayed 8 clock cycles from Serial Data In.
6	NC	Internally unconnected. Recommended connection is GND.
7	RSTb	Reset BAR. Falling Edge resets the device to Max Attenuation [D5:D0] = [000000].
8	CLK	Serial Clock.
9	CSb	Chip Select Bar. Serial Data latched into active register on Rising Edge.
10	NC	Internally unconnected. Recommended connection is GND.
11	SDI	Serial Data Input.
12	NC	Internally unconnected. Recommended connection is GND.
13	NC	Internally unconnected.
14	VDD	Main Supply. Use 3.3V or 5V. Current is < 1 mA.
15	NC	Internally unconnected. Recommended connection is GND.
16	GND	Connect directly to paddle ground or as close as possible to pin with thru via.
17	RF2	Device RF output or input (bi-directional). Must AC couple to this pin.
18	NC	Internally unconnected. Recommended connection is GND.
19	GND	Connect directly to paddle ground or as close as possible to pin with thru via.
20	GND	Connect directly to paddle ground or as close as possible to pin with thru via.
21	GND	Connect directly to paddle ground or as close as possible to pin with thru via.
22	GND	Connect directly to paddle ground or as close as possible to pin with thru via.
23	GND	Connect directly to paddle ground or as close as possible to pin with thru via.
24	GND	Connect directly to paddle ground or as close as possible to pin with thru via.
EP	Exposed Paddle	Connect to Ground with multiple vias for good thermal relief.

**EVKIT SCHEMATIC**

The diagram below describes the recommended applications / EVkit circuit:

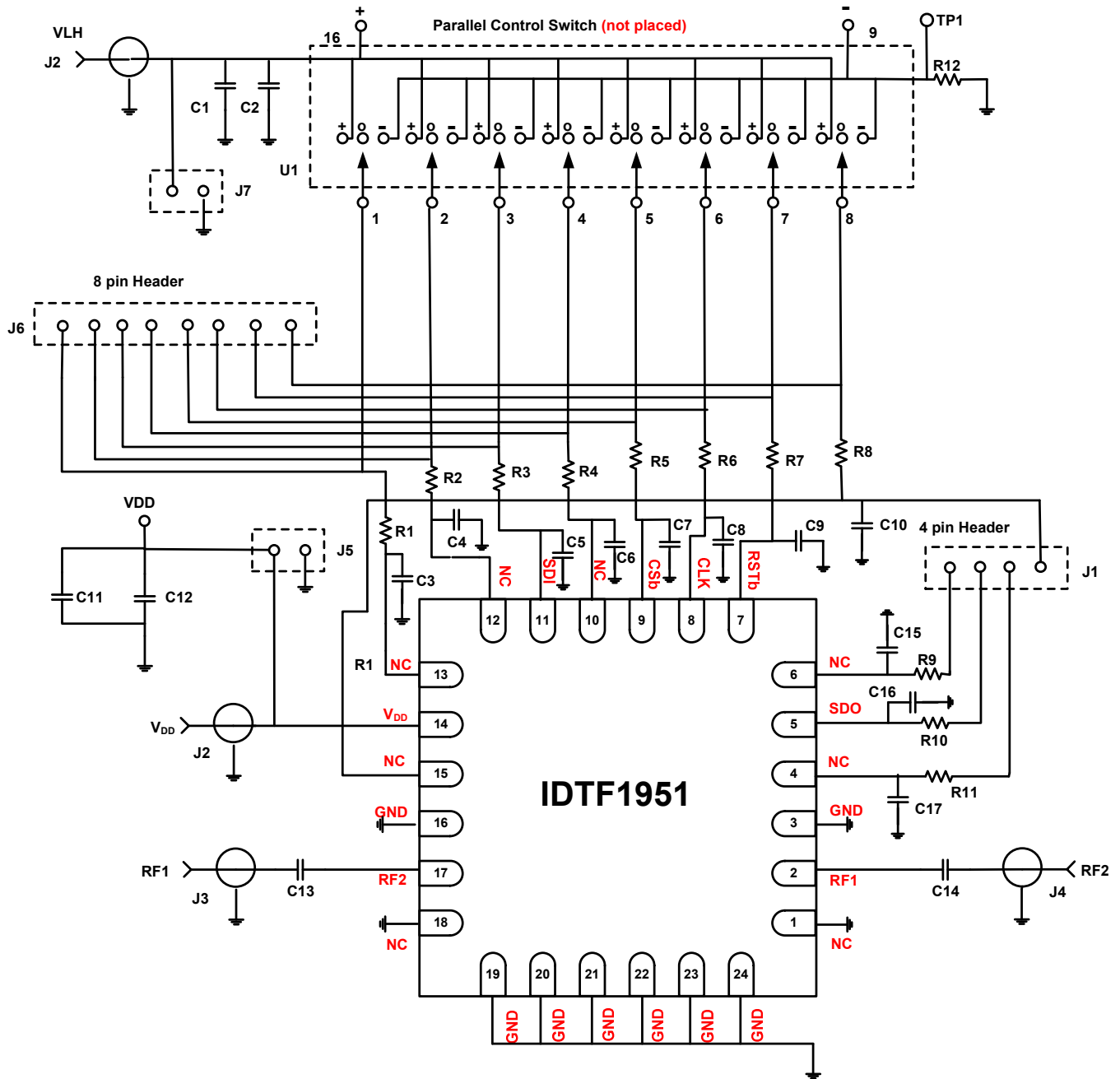

**6-bit 0.5 dB Digital Step Attenuator**
**100 MHz to 4000 MHz**
**EVKIT OPERATION** (Email: [RFsupport@IDT.com](mailto:RFsupport@IDT.com) to request an EVkit, Serial Control HW/SW, or TRL cal board)

The picture and graphic below describe how to operate the EVkit

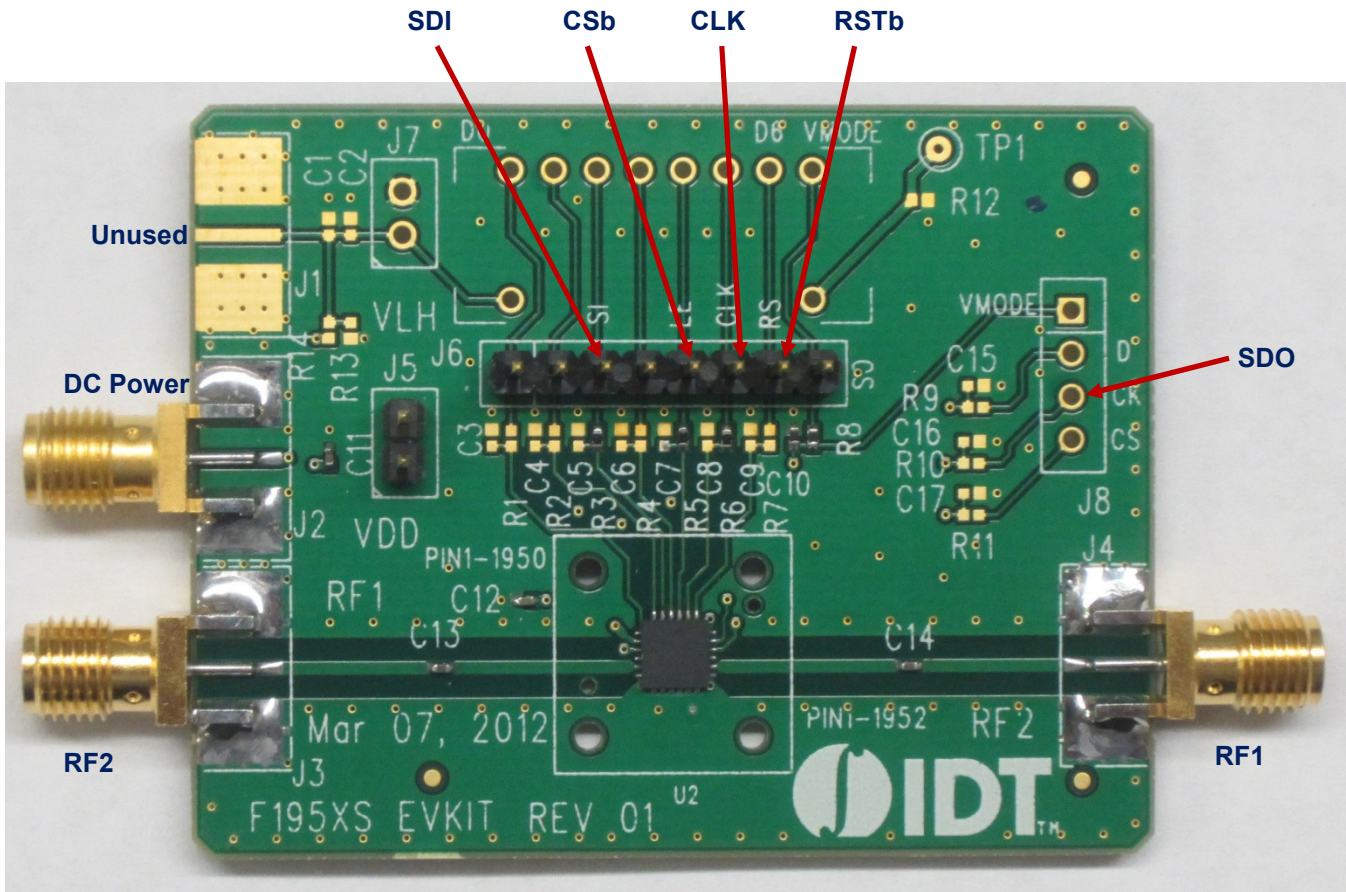



**EVKIT BOM**

F1951 BOM Rev 02 PCB Rev 01 10/26/2012

Item #	Value	Size	Description	Mfr. Part #	Mfr.	Ref Des	Qty
1	1000pF	0402	CAP CER 1000PF 50V C0G 0402	GRM1555C1H102JA01D	MURATA	C13,14	2
2	10nF	0402	CAP CER 10000PF 16V 10% X7R 0402	GRM155R71C103KA01D	MURATA	C12	1
3	0.1uF	0402	CAP CER 0.1UF 16V 10% X7R 0402	GRM155R71C104KA88D	MURATA	C11	1
4	Header 2 Pin	TH 2	CONN HEADER VERT SGL 2POS GOLD	961102-6404-AR	3M	J5	1
5	Header 4 Pin	TH 4	CONN HEADER VERT SGL 4POS GOLD	961104-6404-AR	3M	J8	1
6	Header 8 Pin	TH 8	CONN HEADER VERT SGL 8POS GOLD	961108-6404-AR	3M	J6	1
7	SMA_END_LAUNCH	.062	SMA_END_LAUNCH (Small)	142-0711-821	Emerson Johnson	J2,3,4	3
8	0	0402	RES 0.0 OHM 1/10W 0402 SMD	ERJ-2GE0R00X	Panasonic	R7,8,10	3
9	3K	0402	RES 3.00K OHM 1/10W 1% 0402 SMD	ERJ-2RKF3001X	Panasonic	R3,5,6	3
10	Digital Step Attenuator		F1951	F1951	IDT	U2	1
11	PCB		PCB Rev 01	F195XS Eokit Rev 01			1

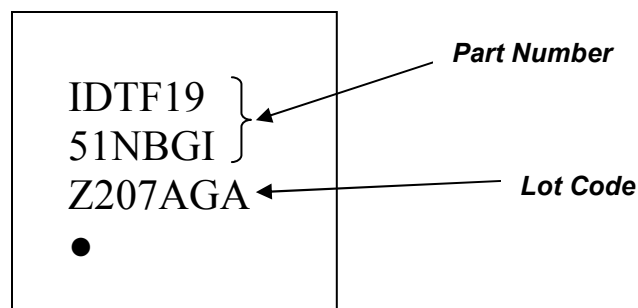
**Total 18**
**TOPMARKINGS**

## **EVKIT THROUGH-REFLECT-LINE (TRL) CALIBRATION**

The “Through-Reflect-Line” (TRL) method [1] is used to de-embed the evaluation board losses from the S-parameter measurements of the F1951. This method requires the use of three standards: a through, a reflection, and a line. The TRL method has the advantage over other calibration methods in that it requires only one of these three standards to be well defined.

The TRL through which is used for the F1951 TRL calibration was constructed identically to the evaluation board, minus the DUT and its corresponding length. Therefore, the through corresponds to a precise zero length connection between the input and output reference planes of the DUT. This through satisfies the requirement of the TRL method that one of the three standards be precisely specified.

The TRL reflection standard used is constructed identically to the input and output lines of the evaluation board, with a short placed at the reference plane of the DUT. In accordance with the TRL method’s requirements, the actual magnitude and phase were not accurately specified, but the phase was known to within 90 degrees and the TRL reflection standard has a magnitude close to one.

The TRL line standard is identical to the TRL through, but with an additional length of 0.8 inches (2 cm). This satisfies the TRL method’s requirement that the TRL be a different length than the TRL through, that it have the same impedance and propagation constant as the through, and that the phase difference between the through and the line be between 20 degrees and 160 degrees. The difference in length yields a phase difference of approximately 20 degrees at 500 MHz, and a phase difference of 160 degrees at 4 GHz.

For characterization of performance from 150 to 500 MHz a separate TRL board with different “Line” length is used.

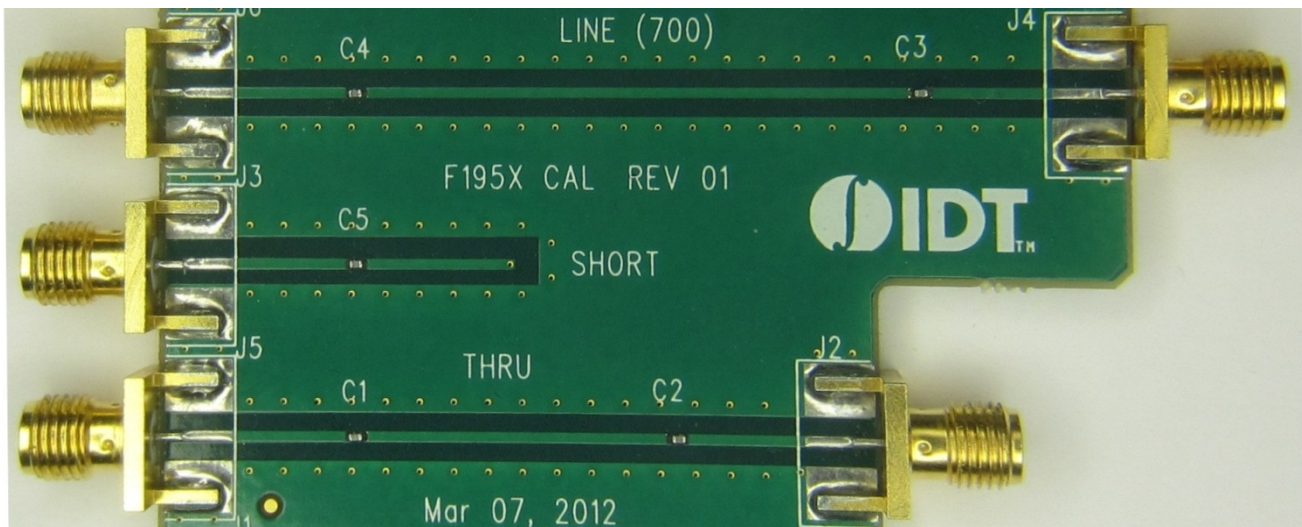

Standards used for F195x TRL calibration

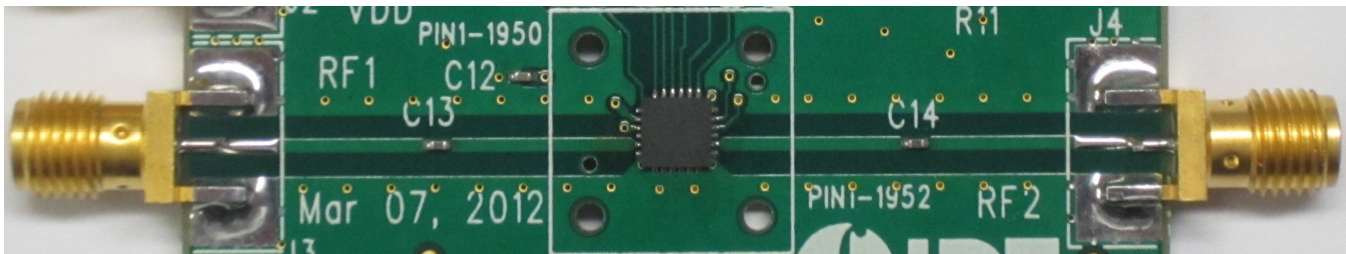

F1951 evaluation circuit

Engen, G.F.; Hoer, C.A.; “Thru-Reflect-Line: An Improved Technique for Calibrating the Dual Six-Port Automatic Network Analyzer,” **IEEE Transactions on Microwave Theory and Techniques**, Volume: 27 Issue:12, pp. 987 – 993, Dec 1979.