



Chipsmall Limited consists of a professional team with an average of over 10 year of expertise in the distribution of electronic components. Based in Hongkong, we have already established firm and mutual-benefit business relationships with customers from,Europe,America and south Asia,supplying obsolete and hard-to-find components to meet their specific needs.

With the principle of "Quality Parts,Customers Priority,Honest Operation,and Considerate Service",our business mainly focus on the distribution of electronic components. Line cards we deal with include Microchip,ALPS,ROHM,Xilinx,Pulse,ON,Everlight and Freescale. Main products comprise IC,Modules,Potentiometer,IC Socket,Relay,Connector.Our parts cover such applications as commercial,industrial, and automotives areas.

We are looking forward to setting up business relationship with you and hope to provide you with the best service and solution. Let us make a better world for our industry!



Contact us

Tel: +86-755-8981 8866 Fax: +86-755-8427 6832

Email & Skype: info@chipsmall.com Web: www.chipsmall.com

Address: A1208, Overseas Decoration Building, #122 Zhenhua RD., Futian, Shenzhen, China



Description

The F2950 is a high power, reflective 50Ω, single-pole double-throw (SP2T) RF switch. This device covers a 100MHz to 8GHz frequency range to support a wide variety of applications including WLAN 802.11.

The F2950 uses a single positive supply voltage and is compatible with both 1.8V and 3.3V control logic.

Competitive Advantage

The F2950 provides extremely low insertion loss across a very broad bandwidth while providing high linearity performance across its operating range.

- Optimized for Wi-Fi applications
- Wide bandwidth
- Low insertion loss
- Excellent linearity
- High power handling for large peak-to-average applications
- Fast switching
- No external matching required
- Minimal footprint

Typical Applications

- 802.11 Wi-Fi
- Wireless Access Points, Gateways and Router Applications
- LTE and 4G Communication Systems
- 2-Way Radios
- General Purpose

Features

- Low insertion loss: 0.58dB at 2.5GHz
- High isolation: 44dB at 2.5GHz
- Excellent linearity:
 - IIP3 +69dBm at 2.4GHz and 5.9GHz
 - IIP2 +115dBm at 2.4GHz
 - IIP2 +117dBm at 5.9GHz
- Second Harmonic: -93dBc at 5.9GHz
- Third Harmonic: -85dBc at 5.9GHz
- Typical switching speed: 170ns
- Supply voltage: +2.7V to +5.5V
- 1.8V and 3.3V compatible control logic
- -40°C to +105°C operating temperature range
- 1.5mm x 1.5mm, 6-pin DFN package

Block Diagram

Figure 1. Block Diagram

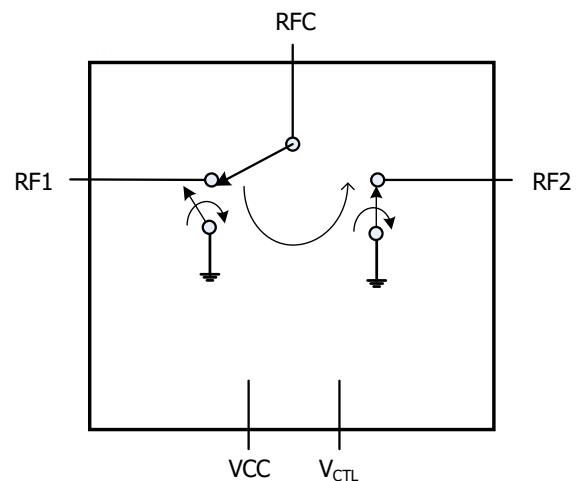

Pin Assignments

Figure 2. Pin Assignments for 1.5mm x 1.5mm x 0.55mm DFN, NEG6 – Top View

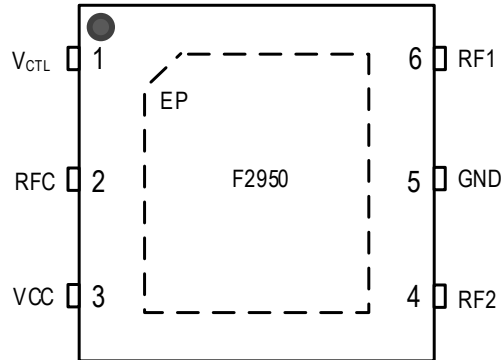

Pin Descriptions

Table 1. Pin Descriptions

Pin	Name	Function
1	V _{CTL}	Logic control pin. See Table 7 for logic control states.
2	RFC	RF common port. Matched to 50Ω in the insertion loss state only. If this pin is not 0V DC, then an external coupling capacitor must be used.
3	V _{CC}	Power supply. Bypass to GND with capacitors as close as possible to the pin.
4	RF2	RF2 port. Matched to 50Ω in the insertion loss state only. If this pin is not 0V DC, then an external coupling capacitor must be used.
5	GND	Ground. Ground this pin as close to the device as possible.
6	RF1	RF1 port. Matched to 50Ω in the insertion loss state only. If this pin is not 0V DC, then an external coupling capacitor must be used.
	EP	Exposed pad. Internally connected to GND. Solder this exposed pad to a PCB pad that uses multiple ground vias to provide heat transfer out of the device into the PCB ground planes. These multiple ground vias are also required to achieve the specified RF performance.

Absolute Maximum Ratings

Stresses beyond those listed below may cause permanent damage to the device. Functional operation of the device at these or any other conditions beyond those indicated in the operational section of this specification is not implied. Exposure to absolute maximum rating conditions for extended periods may affect device reliability.

Table 2. Absolute Maximum Ratings

Parameter		Symbol	Minimum	Maximum	Units
V _{CC} to GND		V _{CC}	-0.3	+6.0	V
V _{CTL} to GND		V _{LOGIC}	-0.3	Lower of (V _{CC} + 0.3, 3.9)	V
RF1, RF2, RFC to GND		V _{RF}	-0.3	+0.3	V
Maximum Input CW Power, Z _S = Z _L = 50Ω, T _{EP} = 25°C, V _{CC} = 5.25V (any port, insertion loss state) [a]	100MHz ≤ f _{RF} ≤ 200MHz	P _{ABSCW1}		28	dBm
	200MHz < f _{RF} ≤ 500MHz	P _{ABSCW2}		29	
	500MHz < f _{RF} ≤ 1GHz	P _{ABSCW3}		30	
	1GHz < f _{RF} ≤ 6GHz	P _{ABSCW4}		31	
	f _{RF} > 6GHz	P _{ABSCW5}		30	
Maximum Peak Power, Z _S = Z _L = 50Ω, T _{EP} = 25°C, V _{CC} = 5.25V (any port, insertion loss state) [a], [b]	100MHz ≤ f _{RF} ≤ 200MHz	P _{ABSPK1}		35	dBm
	200MHz < f _{RF} ≤ 500MHz	P _{ABSPK2}		36	
	500MHz < f _{RF} ≤ 1GHz	P _{ABSPK3}		37	
	1GHz < f _{RF} ≤ 6GHz	P _{ABSPK4}		38	
	f _{RF} > 6GHz	P _{ABSPK5}		37	
Maximum Junction Temperature		T _{JMAX}		+140	°C
Storage Temperature Range		T _{STOR}	-65	+150	°C
Lead Temperature (soldering, 10s)		T _{LEAD}		+260	°C
Electrostatic Discharge – HBM (JEDEC/ESDA JS-001-2012)		V _{ESDHBM}		2000 (Class C2)	V
Electrostatic Discharge – CDM (JEDEC 22-C101F)		V _{ESDCDM}		500 (Class C2)	V

[a] T_{EP} is the temperature of the exposed paddle.

[b] 5% duty cycle of 4.6ms period in a 50Ω environment.

Recommended Operating Conditions

Table 3. Recommended Operating Conditions

Parameter	Symbol	Conditions	Min	Typ	Max	Units
Power Supply Voltage	V_{CC}		2.7 [a]	3.3	5.5	V
Operating Temperature Range	T_{EP}	Exposed paddle	-40	+25	+105	°C
RF Frequency Range	f_{RF}		0.1		8	GHz
RF Input Power [b]	P_{RF_CW}	CW, insertion loss state	See Figure 3			dBm
	P_{RF_PULSE}	5% duty cycle of 4.6ms period, insertion loss state	See Figure 3			
RFC, RF1, RF2 Port Impedance	Z_{RF}			50		Ω

[a] Functional with reduced performance for $2.3V \leq V_{CC} < 2.7V$.

[b] Levels based on: $V_{CC} = 2.7V$ to $5.5V$, $100MHz \leq f_{RF} \leq 8GHz$, $Z_S = Z_L = 50\Omega$. See Figure 3 for power handling derating vs. RF frequency.

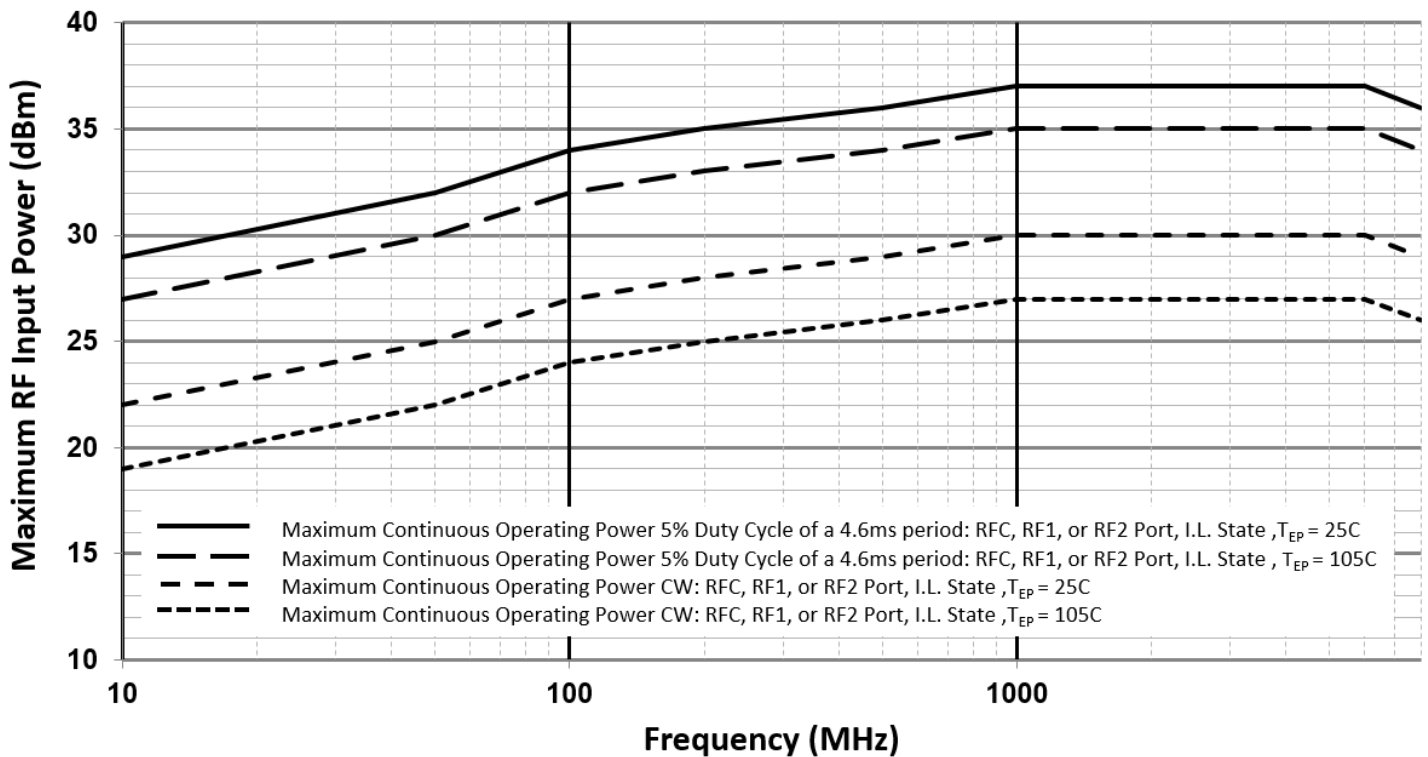
Figure 3. Maximum RF Input Operating Power vs. RF Frequency ($Z_S = Z_L = 50\Omega$)

Electrical Characteristics

Table 4. Electrical Characteristics

See F2950 Typical Application Circuit. Specifications apply when operated with $V_{CC} = +3.3V$, $T_{EP} = +25^{\circ}C$, $P_{IN} = 0dBm$, $Z_S = Z_L = 50\Omega$, single tone and two tone signals applied at RF1 or RF2 and measured at RFC when in the ON state, PCB board trace and connector losses are de-embedded, unless otherwise noted.

Parameter	Symbol	Conditions	Min	Typ	Max	Units
Logic Input High Threshold	V_{IH}	V_{CTL} pin	1.1 [b]		Lower of (V_{CC} , 3.6)	V
Logic Input Low Threshold	V_{IL}	V_{CTL} pin	-0.3		0.6	V
Logic Current	I_{IH}, I_{IL}	V_{CTL} pin	-1		+1	μA
DC Current	I_{CC}			170	250 [a]	μA
Insertion Loss (RF1 or RF2 to RFC)	IL	$f_{RF} = 100MHz$ to $900MHz$		0.54	0.74	dB
		$f_{RF} = 900MHz$ to $2500MHz$ [c]		0.58	0.79	
		$f_{RF} = 2500MHz$ to $3700MHz$		0.61	0.83	
		$f_{RF} = 3700MHz$ to $4900MHz$		0.64	0.88	
		$f_{RF} = 4900MHz$ to $6000MHz$		0.67	0.90	
		$f_{RF} = 6000MHz$ to $8000MHz$		0.73		
Isolation (RF1 or RF2 to RFC)	ISO1	$f_{RF} = 100MHz$ to $900MHz$	48	53		dB
		$f_{RF} = 900MHz$ to $2500MHz$	39	44		
		$f_{RF} = 2500MHz$ to $3700MHz$	35	40		
		$f_{RF} = 3700MHz$ to $4900MHz$	32	37		
		$f_{RF} = 4900MHz$ to $6000MHz$		34		
		$f_{RF} = 6000MHz$ to $8000MHz$		31		
Isolation (RF1 to RF2, RF2 to RF1)	ISO2	$f_{RF} = 100MHz$ to $900MHz$	50	54		dB
		$f_{RF} = 900MHz$ to $2500MHz$	40	44		
		$f_{RF} = 2500MHz$ to $3700MHz$	35	40		
		$f_{RF} = 3700MHz$ to $4900MHz$	32	37		
		$f_{RF} = 4900MHz$ to $6000MHz$		34		
		$f_{RF} = 6000MHz$ to $8000MHz$		30		
Return Loss (RFC, RF1, RF2)	RL	$f_{RF} = 100MHz$ to $900MHz$		25		dB
		$f_{RF} = 900MHz$ to $2500MHz$		23		
		$f_{RF} = 2500MHz$ to $3700MHz$		22		
		$f_{RF} = 3700MHz$ to $4900MHz$		21		
		$f_{RF} = 4900MHz$ to $6000MHz$		20		
		$f_{RF} = 6000MHz$ to $8000MHz$		20		

[a] Items in min/max columns in **bold italics** are guaranteed by test.

[b] Items in min/max columns that are not bold italics are guaranteed by design characterization.

[c] Minimum or maximum specification guaranteed by test at 2.5GHz and by design characterization over the whole frequency range.

Electrical Characteristics

Table 5. Electrical Characteristics

See F2950 Typical Application Circuit. Specifications apply when operated with $V_{CC} = +3.3V$, $T_{EP} = +25^{\circ}C$, $P_{IN} = 0dBm$, $Z_S = Z_L = 50\Omega$, single tone and two tone signals applied at RF1 or RF2 and measured at RFC when in the ON state, PCB board trace and connector losses are embedded, unless otherwise noted.

Parameter	Symbol	Conditions	Min	Typ	Max	Units
Input IP3	IIP3	$f_{RF} = 2.4GHz$ at $P_{IN} = +24dBm$ /tone 100MHz tone spacing		69		dBm
		$f_{RF} = 5.9GHz$ at $P_{IN} = +24dBm$ /tone 100MHz tone spacing		69		
Input IP2	IIP2	$f_1 = 700MHz$, $f_2 = 1.7GHz$ $P_{IN} = +24dBm$ /tone Measure 2.4GHz product		115		dBm
		$f_1 = 2.4GHz$, $f_2 = 3.5GHz$ $P_{IN} = +24dBm$ /tone Measure 5.9GHz product		117		
Second Harmonic	H2	$f_{RF} = 2.4GHz$, $P_{IN} = +30dBm$ Measure 4.8GHz product		104		dBc
		$f_{RF} = 5.9GHz$, $P_{IN} = +30dBm$ Measure 11.8GHz product		93		
Third Harmonic	H3	$f_{RF} = 2.4GHz$, $P_{IN} = +30dBm$ Measure 7.2GHz product		85		dBc
		$f_{RF} = 5.9GHz$, $P_{IN} = +30dBm$ Measure 17.7GHz product		85		
Input 1dB compression [c]	P1dB	$f_{RF} = 2.4GHz$		40		dBm
		$f_{RF} = 6GHz$		40		
		$f_{RF} = 8GHz$		39		
Spurious Output [d]	Pspur1	$f_{OUT} > 5MHz$ All ports terminated, RBW = 100Hz		-97		dBm
	Pspur2	$f_{OUT} \leq 5MHz$ All ports terminated, RBW = 100Hz		-125		
Maximum Video Feed-Through on RF Ports	VID _{FT}	Peak transient during switching. Measured with 20ns rise time, 0V to 3.3V (3.3V to 0V) control pulse applied to V_{CTL} .	Rise	10		mVpp
			Fall	21		
Switching Time [e]	SW _{TIME}	50% V_{CTL} to 90% RF		170	230	ns
		50% V_{CTL} to 10% RF		170	230	
		50% V_{CTL} to 99% RF		190	270	
		50% V_{CTL} to 1% RF		190	270	
Maximum Switching Rate	SW _{RATE}			125		kHz

[a] Items in min/max columns in **bold italics** are guaranteed by test.

[b] Items in min/max columns that are not bold italics are guaranteed by design characterization.

[c] The input 1dB compression point is a linearity figure of merit. Refer to the "Absolute Maximum Ratings" section and Figure 3 for the maximum RF input power.

[d] Spurious due to on-chip negative voltage generator. Spurious fundamental is approximately 5.7MHz.

[e] $f_{RF} = 1GHz$. Rise and fall time of $V_{CTL} = 20ns$.

Thermal Characteristics

Table 6. Package Thermal Characteristics

Parameter	Symbol	Value	Units
Junction to Ambient Thermal Resistance	θ_{JA}	200	°C/W
Junction to Case Thermal Resistance (Case is defined as the exposed paddle)	θ_{JC_BOT}	132	°C/W
Moisture Sensitivity Rating (Per J-STD-020)		MSL 1	

Typical Operating Conditions (TOCs)

Unless otherwise noted:

- $V_{CC} = +3.3V$
- $T_{EP} = 25^{\circ}C$
- $Z_S = Z_L = 50\Omega$
- $f_{RF} = 1GHz$
- Small signal tests done at 0dBm input power
- All temperatures are referenced to the exposed paddle
- Evaluation Kit traces and connector losses are de-embedded

Typical Performance Characteristics [1]

Figure 4. RF1 to RFC Insertion Loss vs. Frequency across Temperature

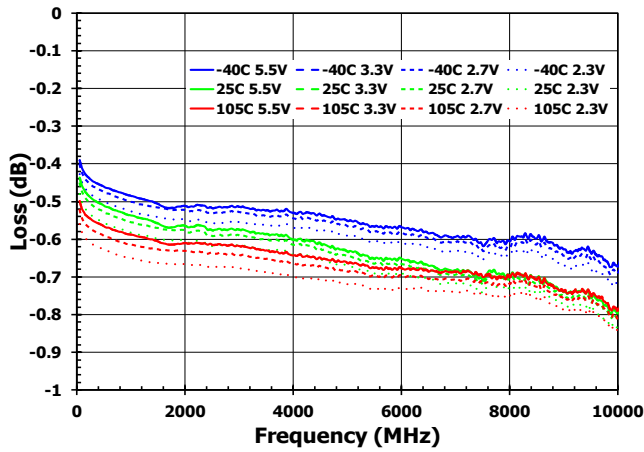

Figure 5. RF2 to RFC Insertion Loss vs. Frequency across Temperature

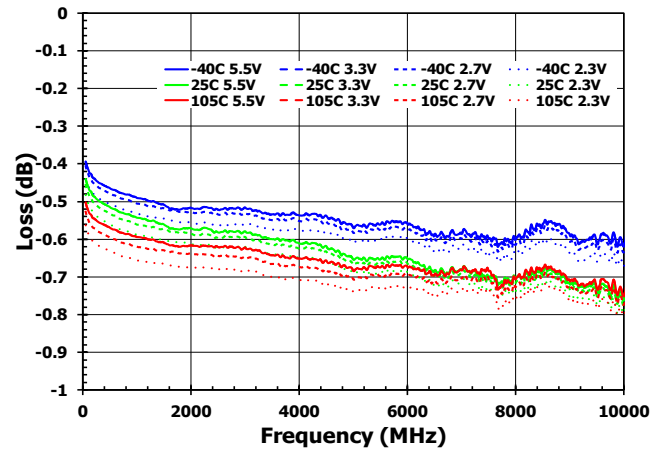

Figure 6. RF1 to RFC Isolation vs. Frequency across Temperature

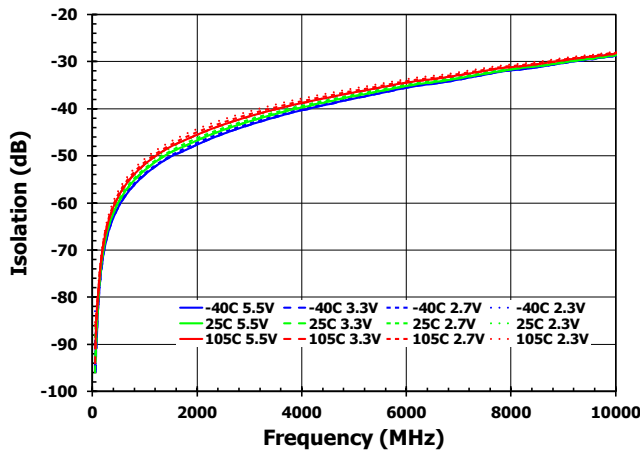

Figure 7. RF2 to RFC Isolation vs. Frequency across Temperature

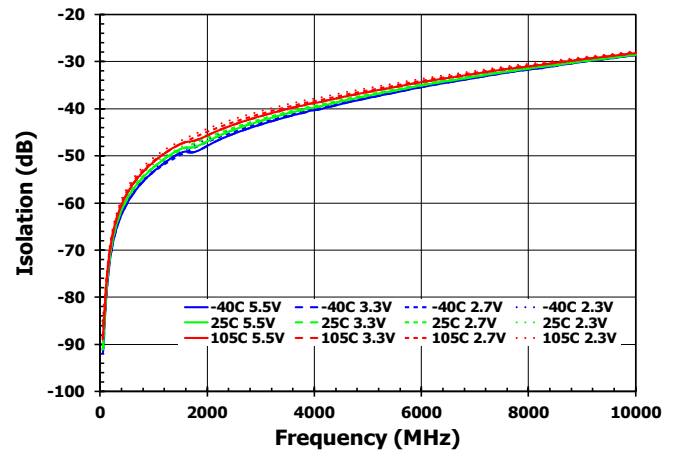

Figure 8. RF1 to RF2 Isolation vs. Frequency across Temperature [RF1 Selected]

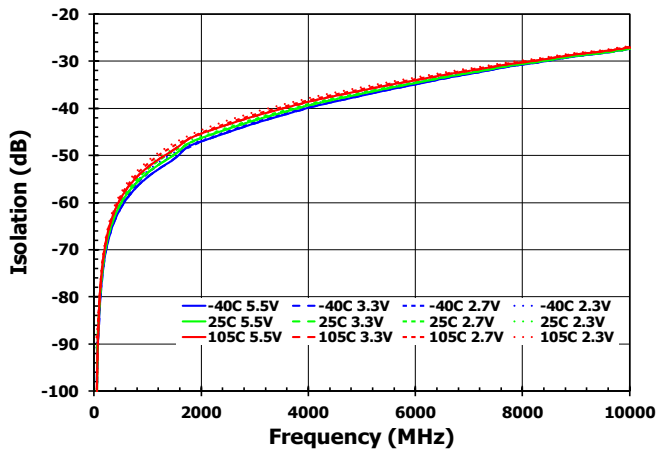
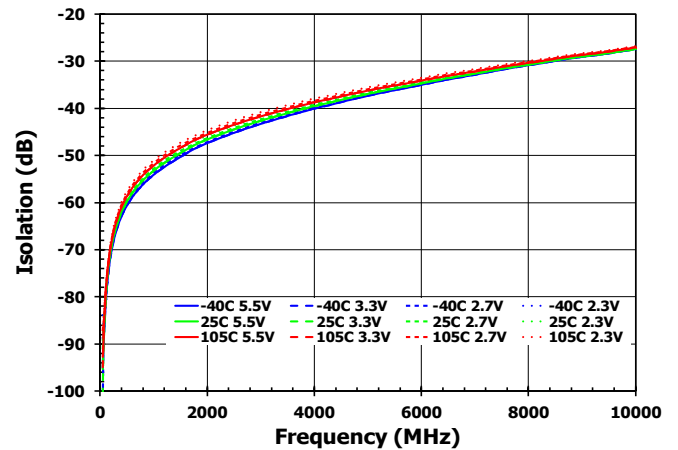

Figure 9. RF2 to RF1 Isolation vs. Frequency across Temperature [RF2 Selected]



Typical Performance Characteristics [2]

Figure 10. RF1 Return Loss vs. Frequency across Temperature [RF1 Selected]

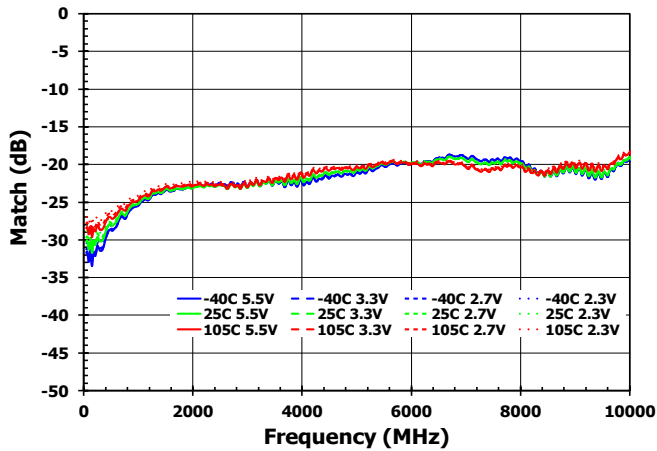

Figure 11. RF2 Return Loss vs. Frequency across Temperature [RF2 Selected]

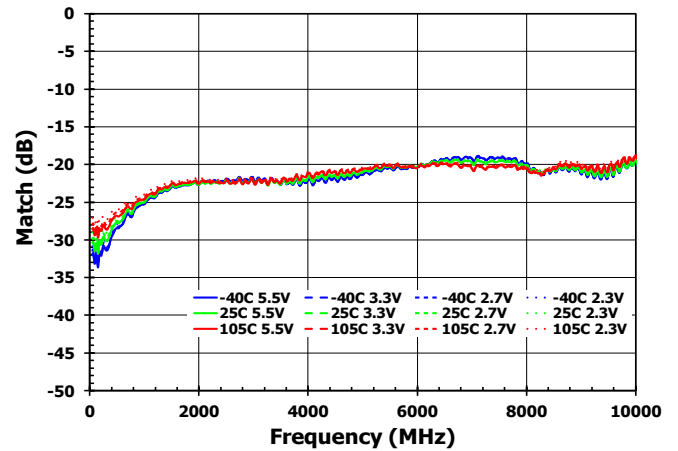

Figure 12. RFC Return Loss vs. Frequency across Temperature [RF1 Selected]

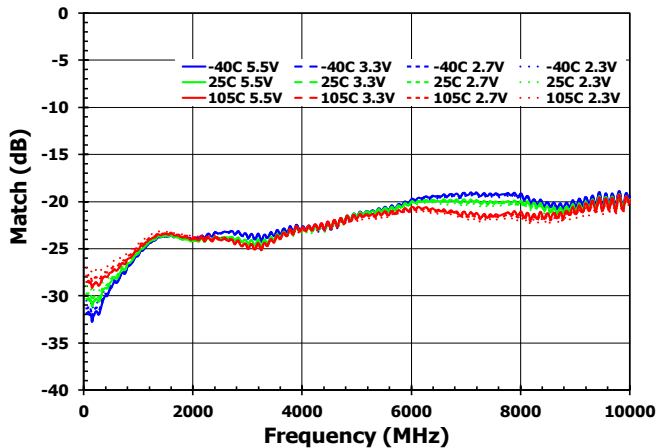

Figure 13. RFC Return Loss vs. Frequency across Temperature [RF2 Selected]

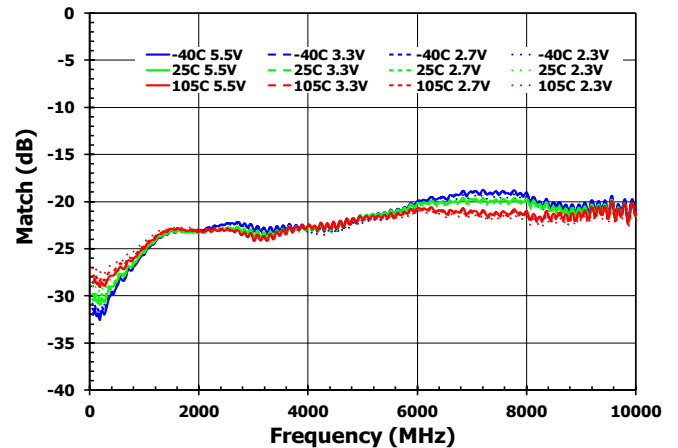
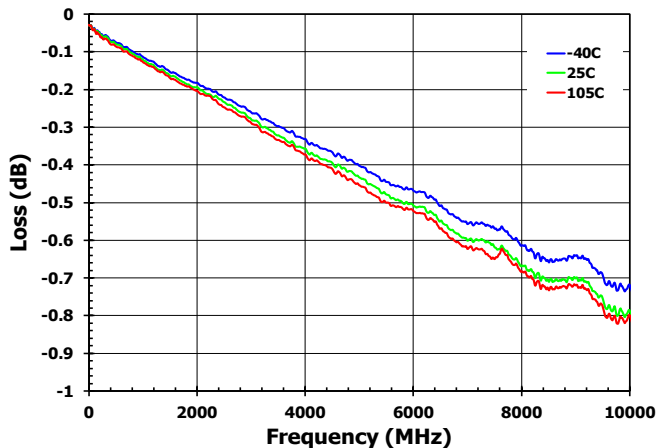

Figure 14. EVKit PCB and Connector Thru Loss vs. Frequency across Temperature



Typical Performance Characteristics [3]

Figure 15. Switching Time Isolation to Insertion Loss State

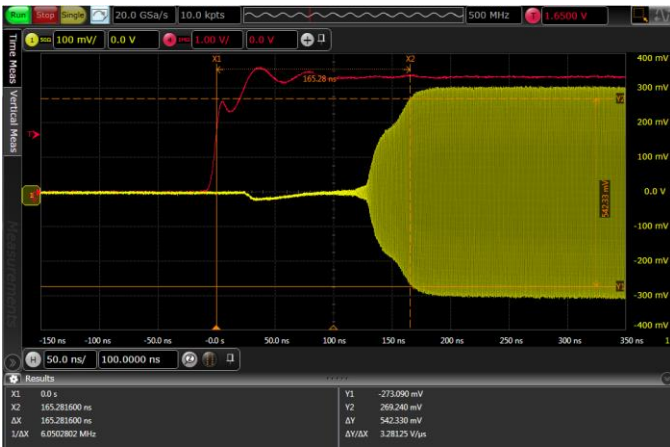
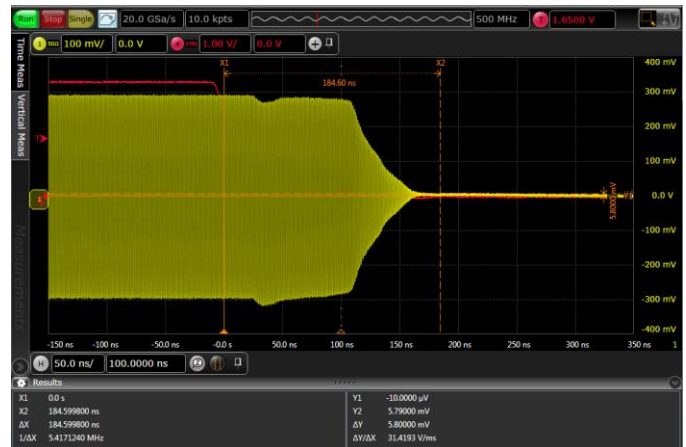

Figure 16. Switching Time Insertion Loss to Isolation State



Control Mode

Table 7. Switch Control Truth Table

V _{CTL}	RFC to RF1	RFC to RF2
LOW	OFF	ON
HIGH	ON	OFF

Application Information

Default Start-up

The V_{CTL} control pin includes no internal pull-down resistors to logic LOW or pull-up resistors to logic HIGH.

Power Supplies

A common V_{CC} power supply should be used for all pins requiring DC power. All supply pins should be bypassed with external capacitors to minimize noise and fast transients. Supply noise can degrade noise figure and fast transients can trigger ESD clamps and cause them to fail. Supply voltage change or transients should have a slew rate slower than 1V / 20μs. In addition, all control pins should remain at 0V (± 0.3V) while the supply voltage ramps up or while it returns to zero.

Control Pin Interface

If a clean control signal cannot be guaranteed due to overshoot, undershoot, ringing, etc., the following circuit at the input of the control pin is recommended.

Figure 17. Control Pin Signal Integrity Improvement Circuit

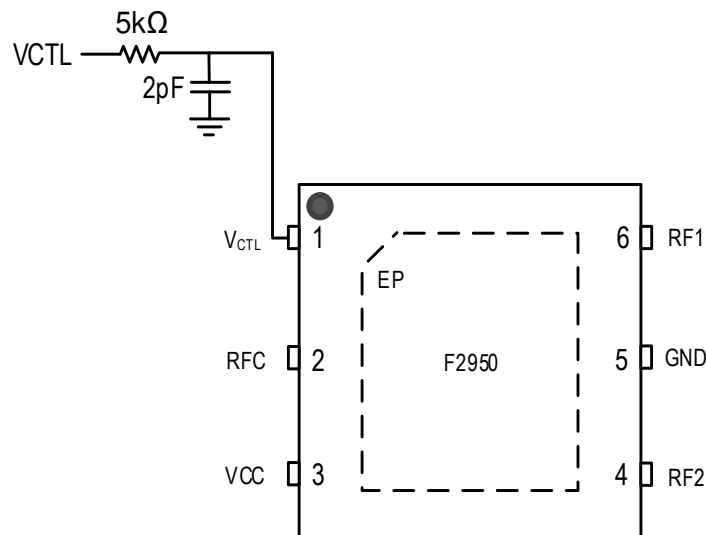

Evaluation Kit Picture

Figure 18. Top View

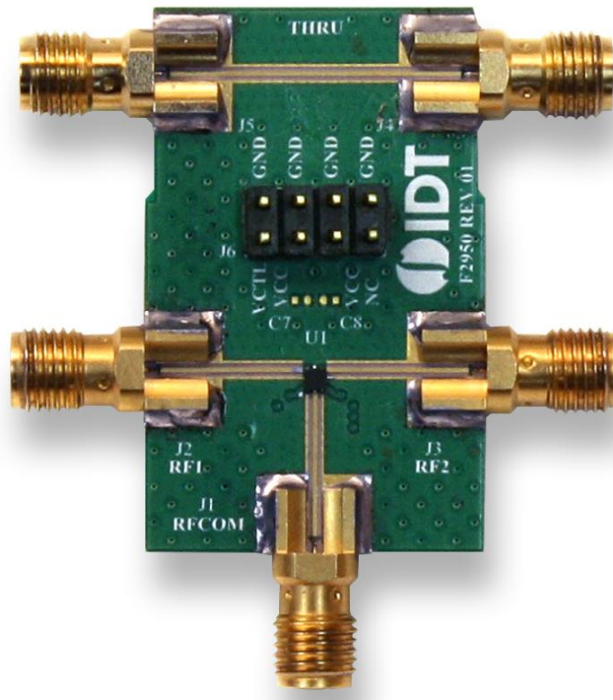
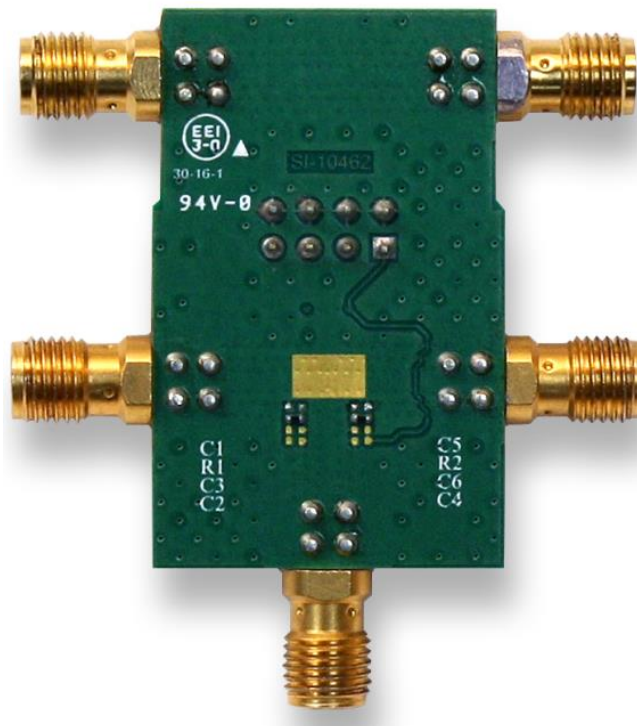

Figure 19. Bottom View



Evaluation Kit / Applications Circuit

Figure 20. Electrical Schematic

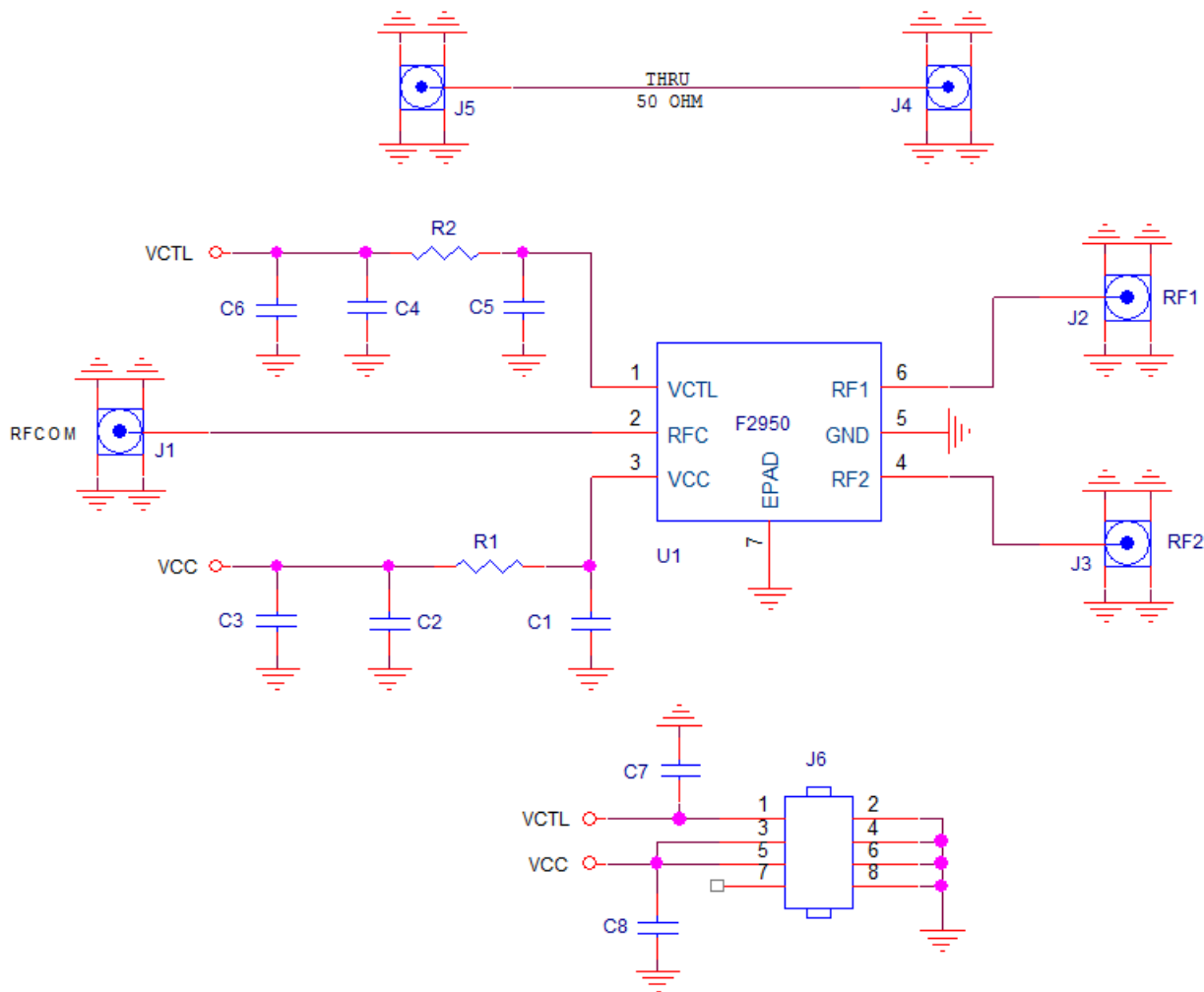

Table 8. Bill of Material (BOM)

Part Reference	QTY	Description	Manufacturer Part #	Manufacturer
C1	1	0.1 μ F \pm 10%, 16V, X7R, Ceramic Capacitor (0402)	GRM155R71C104K	Murata
C2 – C8	0	Not Installed (0402)		
R1, R2	2	0 Ω , 1/10W, Jumper (0402)	ERJ-2GE0R00X	Panasonic
J1 – J5	5	50 Ω Edge SMA Connector	142-0761-881	Cinch Connectivity
J6	1	Conn Header Vert 4x2 Pos Gold	67997-108HLF	Amphenol FCI
U1	1	SP2T Switch 1.5mm x 1.5mm 6-pin NEG6 DFN	F2950NEGK6	IDT
	1	Printed Circuit Board	F2950 EVKit	IDT

Evaluation Kit (EVKit) Operation

External Supply Setup

Set up a V_{CC} power supply in the voltage range of 2.7V to 5.5V with the power supply output disabled.

Connect the disabled V_{CC} supply connection to J6 pin 3 or 5 and GND to J6 pin 2, 4, 6, or 8.

Logic Control Setup

With the logic control line disabled, set the logic HIGH and LOW levels to satisfy the levels stated in the electrical specifications table.

Connect the disabled logic control line to VCTL (pin 1 of J6) and GND to J6 pin 2, 4, 6, or 8.

Turn On Procedure

Set up the supplies and EVKit as noted in the “External Supply Setup” and “Logic Control Setup” sections above.

Enable the V_{CC} supply.

Enable the logic control signal.

Set the VCTL logic setting to achieve the desired Table 7 configuration. Note that the VCTL control logic should not be applied without V_{CC} being present.

Enable any RF signal.

Turn Off Procedure

Disable any applied RF signal.

Set VCTL to GND.

Disable the V_{CC} supply.

Package Drawings

Figure 21. Package Outline Drawing – NEG6 Package

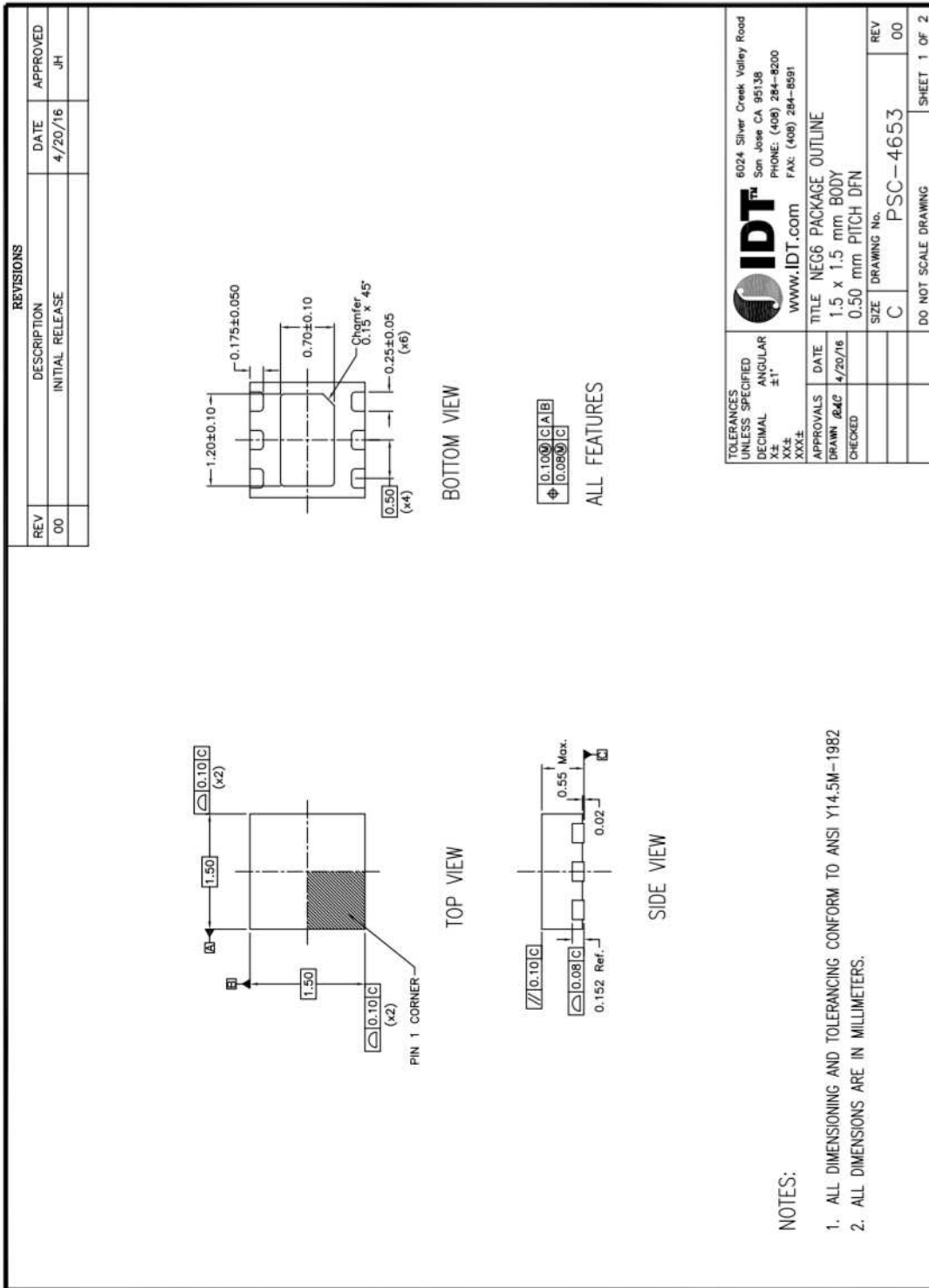

Recommended Land Pattern

Figure 22. Recommended Land Pattern – NEG6 Package

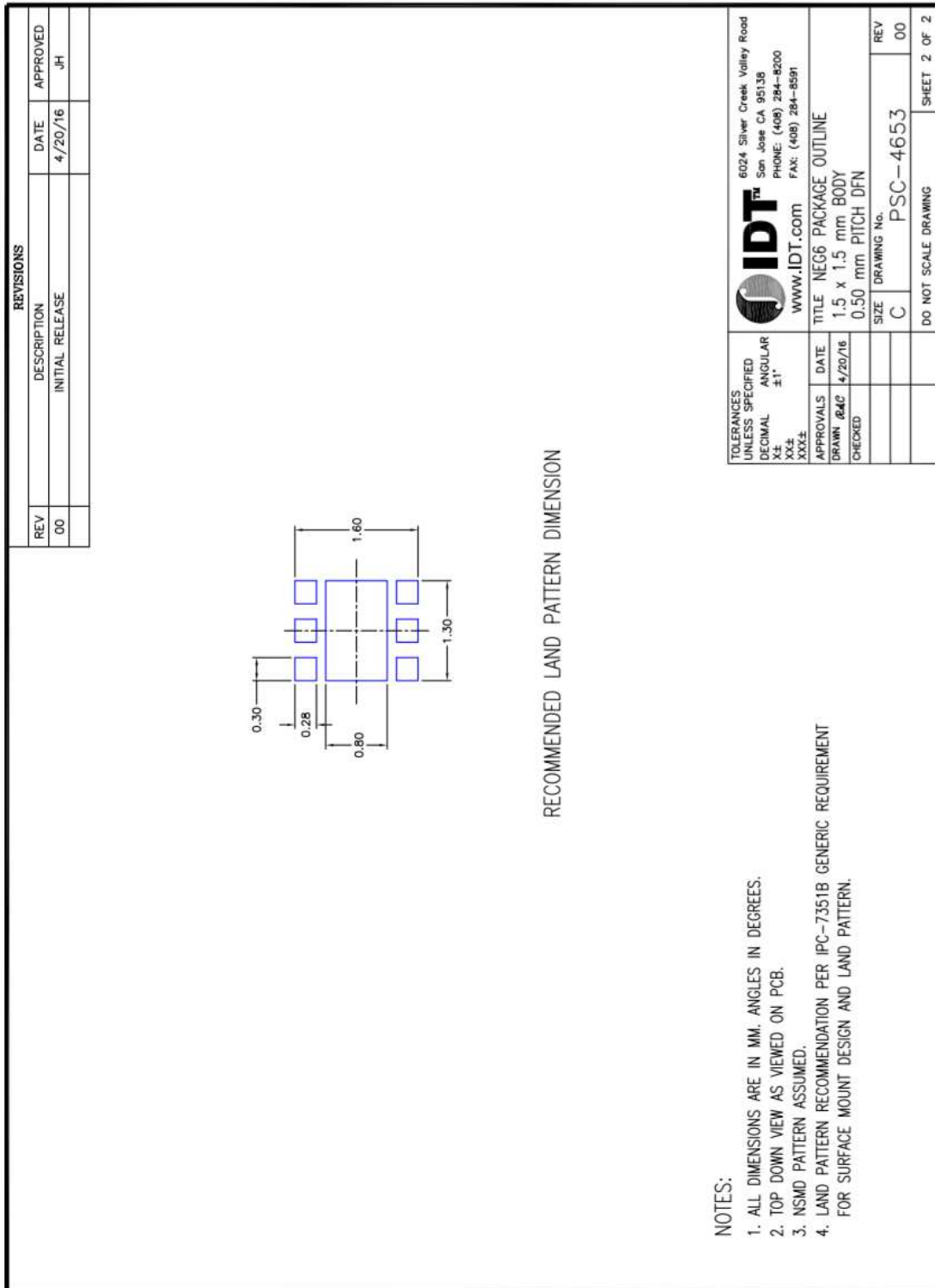

Marking Diagram

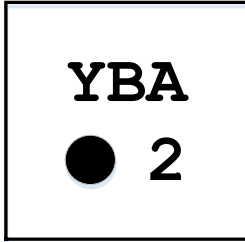

1. Line 1: Y = last digit of the year, BA = sequential letters for traceability purposes
2. Line 2: Pin 1 dot, 2 = F2950 part number code

Ordering Information

Orderable Part Number	Package	MSL Rating	Shipping Packaging	Temperature
F2950NEGK	1.5mm x 1.5mm x 0.55mm NEG6 DFN	MSL1	Cut Tape	-40°C to +105°C
F2950NEGK8	1.5mm x 1.5mm x 0.55mm NEG6 DFN	MSL1	Reel	-40°C to +105°C
F2950EVBI	Evaluation Board			

Revision History

Revision	Revision Date	Description of Change
Rev 0	August 8, 2017	Initial Release



Corporate Headquarters

6024 Silver Creek Valley Road
 San Jose, CA 95138
www.IDT.com

Sales

1-800-345-7015 or 408-284-8200
 Fax: 408-284-2775
www.IDT.com/go/sales

Tech Support

www.IDT.com/go/support

DISCLAIMER Integrated Device Technology, Inc. (IDT) and its affiliated companies (herein referred to as "IDT") reserve the right to modify the products and/or specifications described herein at any time, without notice, at IDT's sole discretion. Performance specifications and operating parameters of the described products are determined in an independent state and are not guaranteed to perform the same way when installed in customer products. The information contained herein is provided without representation or warranty of any kind, whether express or implied, including, but not limited to, the suitability of IDT's products for any particular purpose, an implied warranty of merchantability, or non-infringement of the intellectual property rights of others. This document is presented only as a guide and does not convey any license under intellectual property rights of IDT or any third parties.

IDT's products are not intended for use in applications involving extreme environmental conditions or in life support systems or similar devices where the failure or malfunction of an IDT product can be reasonably expected to significantly affect the health or safety of users. Anyone using an IDT product in such a manner does so at their own risk, absent an express, written agreement by IDT.

Integrated Device Technology, IDT and the IDT logo are trademarks or registered trademarks of IDT and its subsidiaries in the United States and other countries. Other trademarks used herein are the property of IDT or their respective third party owners. For datasheet type definitions and a glossary of common terms, visit www.idt.com/go/glossary. All contents of this document are copyright of Integrated Device Technology, Inc. All rights reserved.