



Chipsmall Limited consists of a professional team with an average of over 10 year of expertise in the distribution of electronic components. Based in Hongkong, we have already established firm and mutual-benefit business relationships with customers from,Europe,America and south Asia,supplying obsolete and hard-to-find components to meet their specific needs.

With the principle of “Quality Parts,Customers Priority,Honest Operation,and Considerate Service”,our business mainly focus on the distribution of electronic components. Line cards we deal with include Microchip,ALPS,ROHM,Xilinx,Pulse,ON,Everlight and Freescale. Main products comprise IC,Modules,Potentiometer,IC Socket,Relay,Connector.Our parts cover such applications as commercial,industrial, and automotives areas.

We are looking forward to setting up business relationship with you and hope to provide you with the best service and solution. Let us make a better world for our industry!



## Contact us

Tel: +86-755-8981 8866 Fax: +86-755-8427 6832

Email & Skype: info@chipsmall.com Web: www.chipsmall.com

Address: A1208, Overseas Decoration Building, #122 Zhenhua RD., Futian, Shenzhen, China



### F48-400

#### Description:

The F48-400 is a single primary and dual secondary, split bobbin design which operates with an input of 115V. The output voltage will be either 48.0V with a center-tap under a 0.4A load with the secondaries wired in series, or 24.0V under a 0.8A load with the secondaries wired in parallel. The split bobbin design eliminates the need for costly electrostatic shielding.

#### Electrical Specifications (@25C)

1. Maximum Power: 20.0VA
2. Primary: 115V
3. Secondary: Series: 48.0V CT@ 0.4A  
Parallel: 24.0V @ 0.8A
4. Voltage Regulation: 25% TYP @ full load to no load
5. Temperature Rise: 25C TYP
6. Hipot tested 100% at 2500 VRMS

#### Construction:

Three flange bobbin construction with primaries and secondaries wound side by side for low capacitive coupling.

#### Agency File:

UL: File E53148, UL 5085-2 (506), Class B General Purpose Transformer,  
cUL: File E53148, UL 5085-2 (506), Class B General Purpose Transformer,  
Canadian Use (CSA 22.2, No.66.2-06)

This model is also available in Class 3, UL 5085-3 (1585) version as [F48-400-C2](#)



#### Dimensions:

Units in inches.

H	W	L	A	B	C	D	E	F
1.437	1.875	2.25	0.300	0.400	1.600	0.041	0.020	0.234

Weight: 0.80 lbs

#### Schematic:

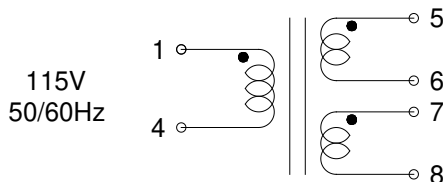

**RoHS Compliance:** As of manufacturing date February 2005, all standard products meet the requirements of 2011/65/EU, known as the RoHS initiative.

As of April 7, 2008, UL standards 506 and 1585 will be migrated to UL 5085-2 and 5085-3, respectively.

\*Upon printing, this document is considered "uncontrolled". Please contact Triad Magnetics website for the most current version. For soldering and washing information please see <http://www.triadmagnetics.com/faq.html>

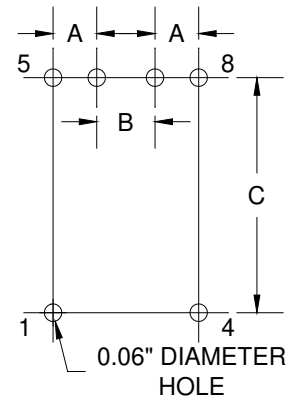
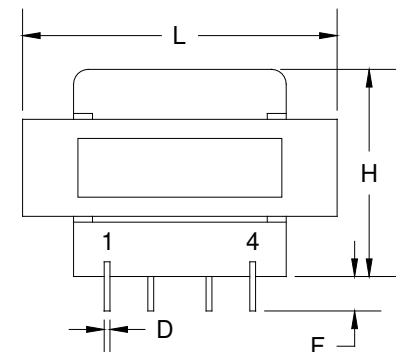
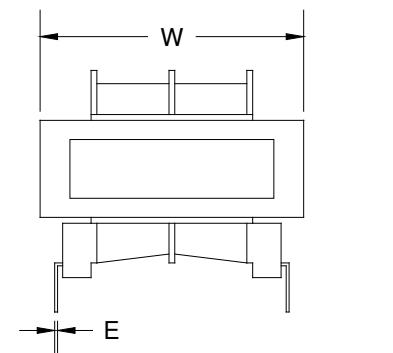

#### Board Layout