



Chipsmall Limited consists of a professional team with an average of over 10 year of expertise in the distribution of electronic components. Based in Hongkong, we have already established firm and mutual-benefit business relationships with customers from,Europe,America and south Asia,supplying obsolete and hard-to-find components to meet their specific needs.

With the principle of “Quality Parts,Customers Priority,Honest Operation,and Considerate Service”,our business mainly focus on the distribution of electronic components. Line cards we deal with include Microchip,ALPS,ROHM,Xilinx,Pulse,ON,Everlight and Freescale. Main products comprise IC,Modules,Potentiometer,IC Socket,Relay,Connector.Our parts cover such applications as commercial,industrial, and automotives areas.

We are looking forward to setting up business relationship with you and hope to provide you with the best service and solution. Let us make a better world for our industry!



Contact us

Tel: +86-755-8981 8866 Fax: +86-755-8427 6832

Email & Skype: info@chipsmall.com Web: www.chipsmall.com

Address: A1208, Overseas Decoration Building, #122 Zhenhua RD., Futian, Shenzhen, China



REVISIONS		
ISS	ZONE	DESCRIPTION\PER REQUEST\DATE

CONFIGURATION CONTROL:
NO CHANGES PERMITTED TO DRAWING WITHOUT
PPAP QUALIFIED CUSTOMER APPROVAL

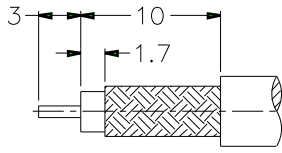

RECOMMENDED
CABLE STRIPPING DIM'S

1. CRIMPED FERRULE
HEX CRIMP SIZE .213"
2. CRIMPED CONTACT PIN
SQ. CRIMP SIZE .042"

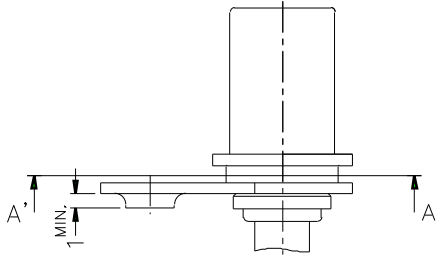
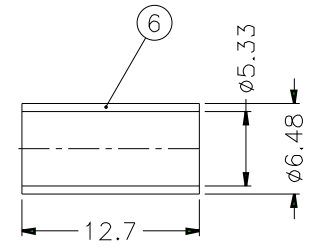
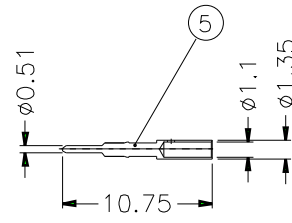
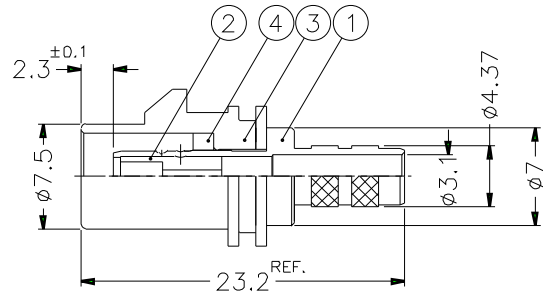
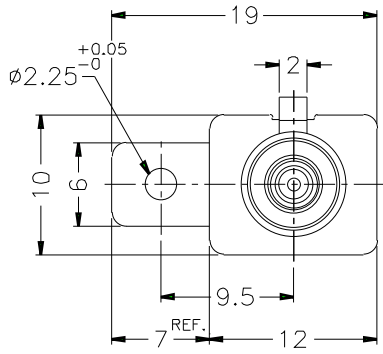

- NOTES: FINISH (PLATING THICKNESS IN MICRO-INCHES)
1. BRASS PER QQ-B-626, ALLOY 360, 1/2 H ; JIS H3250 C 3604BD OR EQUIVALENT
 2. NICKEL PL. 60 MIN. THICK OVER COPPER STRIKE
 3. GOLD PL. 30 MIN. THICK OVER NICKEL PL. 100 MIN. THICK OVER COPPER STRIKE
 4. TEFLON MIL-P-19468 OR EQUIVALENT
 5. COPPER PER ASTM B-75 ALLOY C12200 OR EQUIVALENT
 6. PBT(WITH 15% GLASS FIBER) PER CHANG CHUN GRADE 4115202 OR EQUIVALENT

TABLE

KEY CODING	D/N	P/N	LOCK COVER
A	FK1321AW-008-NT30G-50	FA1-NASP-C04-0	FKLC10201A
B	FK1321BW-008-NT30G-50	FA1-NBSP-C04-0	FKLC10202A
C	FK1321CW-008-NT30G-50	FA1-NCSP-C04-0	FKLC10203A
D	FK1321DW-008-NT30G-50	FA1-NDSP-C04-0	FKLC10204A
E	FK1321EW-008-NT30G-50	FA1-NESP-C04-0	FKLC10205A
F	FK1321FW-008-NT30G-50	FA1-NFSP-C04-0	FKLC10206A
G	FK1321GW-008-NT30G-50	FA1-NGSP-C04-0	FKLC10207A
H	FK1321HW-008-NT30G-50	FA1-NHSP-C04-0	FKLC10208A
I	FK1321IW-008-NT30G-50	FA1-NISP-C04-0	FKLC10209A
K	FK1321KW-008-NT30G-50	FA1-NKSP-C04-0	FKLC10210A
Z	FK1321ZW-008-NT30G-50	FA1-NZSP-C04-0	FKLC10211A

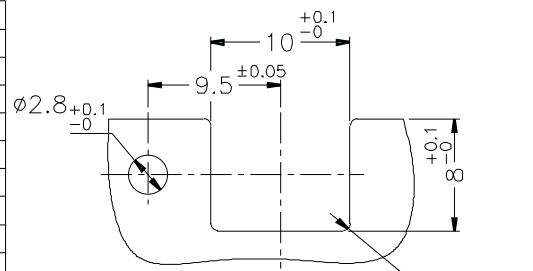

RECOMMENDED
MOUNTING HOLE

NO.	DESCRIPTION	MATERIAL	FINISH	Q'TY	DRAWING NO.
6	FERRULE	NOTE 5	NOTE 2	1	FKFR00201A
5	CONTACT PIN	NOTE 1	NOTE 3	1	FKCP00301A
4	RING	NOTE 1	NOTE 2	1	FKLR00101A
3	LOCK COVER	NOTE 6		1	SEE TABLE
2	INSULATOR	NOTE 4	NATURAL	1	FKNS00401A
1	MAIN BODY	NOTE 1	NOTE 2	1	FKMB00201A

DIMENSIONS ARE IN MILLIMETERS			
UNLESS OTHERWISE SPECIFIED	TOLERANCES		
0.5-6	= ±0.2		
6-30	= ±0.4		
30-120	= ±0.6		
120-315	= ±1		
315-1000	= ±1.6		
1000-2000	= ±2.4		

PART NO.	
FA1-NXSP-C04-0	
APPROVED	DATE
	09-25-01'
CHECKED	DATE
	09-25-01'
DRAWN	DATE
ANGELA	09-25-01'

Amphenol
Danbury,CT,USA-Tainan,Taiwan-Shenzehn,China

TITLE
FAKRA SMB CRIMP PLUG
(FOR RG-58A/U, 58C/U CABLE)

DRAWING NO.
KJ-FK1321XX-008-NT30G-50

FILE NO. F:\DWG\FK\FA1\NXSP\C04\0