



Chipsmall Limited consists of a professional team with an average of over 10 year of expertise in the distribution of electronic components. Based in Hongkong, we have already established firm and mutual-benefit business relationships with customers from,Europe,America and south Asia,supplying obsolete and hard-to-find components to meet their specific needs.

With the principle of "Quality Parts,Customers Priority,Honest Operation,and Considerate Service",our business mainly focus on the distribution of electronic components. Line cards we deal with include Microchip,ALPS,ROHM,Xilinx,Pulse,ON,Everlight and Freescale. Main products comprise IC,Modules,Potentiometer,IC Socket,Relay,Connector.Our parts cover such applications as commercial,industrial, and automotives areas.

We are looking forward to setting up business relationship with you and hope to provide you with the best service and solution. Let us make a better world for our industry!



Contact us

Tel: +86-755-8981 8866 Fax: +86-755-8427 6832

Email & Skype: info@chipsmall.com Web: www.chipsmall.com

Address: A1208, Overseas Decoration Building, #122 Zhenhua RD., Futian, Shenzhen, China



FAN2564 300mA Low V_{IN} LDO for Digital Applications

Features

- Input Voltage 1.65V to 3.6V
- Guaranteed 300mA Output
- High Initial Output Voltage Accuracy: $\pm 1\%$
- Fixed Output Voltage options from 1.2V to 2.8V
- Very Low Dropout: 100mV at 300mA
- 45 μ A Quiescent Current at No Load
- Low Output Noise of 100 μ V_{RMS}
- Inrush Current Controlled to Less Than 500mA
- PSRR of 60dB at 1kHz
- 100 μ s Startup Time
- Stable with Ceramic Capacitors
- Thermal and Short-Circuit Protection
- 4-bump WLCSP, 0.5mm Pitch
- 6-pin 2 x 2mm UMLP

Applications

- Post Regulator
- Cell Phones and Smart Phones
- WLAN, 3G, and 4G Data Cards
- PMP and MP3 Players

Description

The FAN2564 operates from a minimum input of 1.65V and provides outputs as low as 1.2V. Output current is guaranteed to 300mA, making this regulator ideal for digital loads.

The unique low input voltage capability and very low dropout make this device an ideal post regulator to a synchronous buck regulator. In this configuration, accurate low voltage regulation is provided without the inefficiencies typically related to linear regulators.

The enable pin can be used to initiate shutdown mode, where the operating current falls to an extremely low 10nA, typically.

The FAN2564 is designed to be stable with space-saving ceramic capacitors as small as 0402 case size.

The FAN2564 is available in 4-bump 0.5mm pitch wafer-level chip-scale package (WLCSP) and a 6-lead 2 x 2mm ultra-thin molded leadless package (UMLP).

Typical Application Circuit

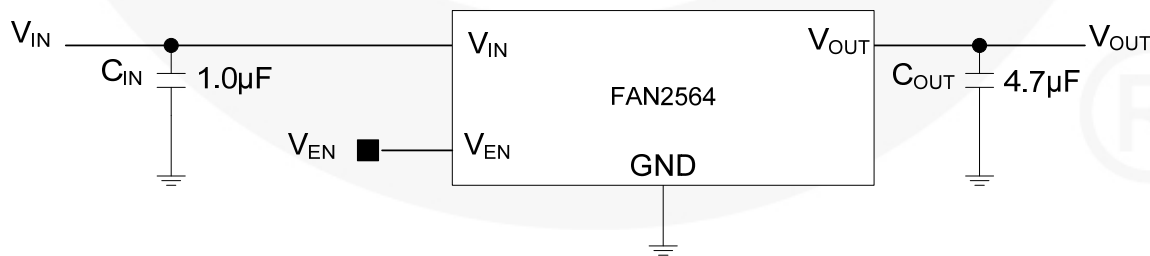

Figure 1. Typical Application Circuit

Ordering Information

Part Number	Output Voltage ⁽¹⁾	Temperature Range	Package	Packing Method
FAN2564UC12X	1.2	-40 to 85°C	WLCSP-4 0.5mm Pitch	Tape and Reel
FAN2564UC13X	1.3			
FAN2564UC15X	1.5			
FAN2564UC18X	1.8			
FAN2564UC25X	2.5			
FAN2564UMP12X	1.2	-40 to 85°C	6 Lead UMLP 2 x 2mm	Tape and Reel
FAN2564UMP13X	1.3			
FAN2564UMP15X	1.5			
FAN2564UMP18X	1.8			

Notes:

1. Other voltage options available upon request. Contact a Fairchild representative.

Block Diagram

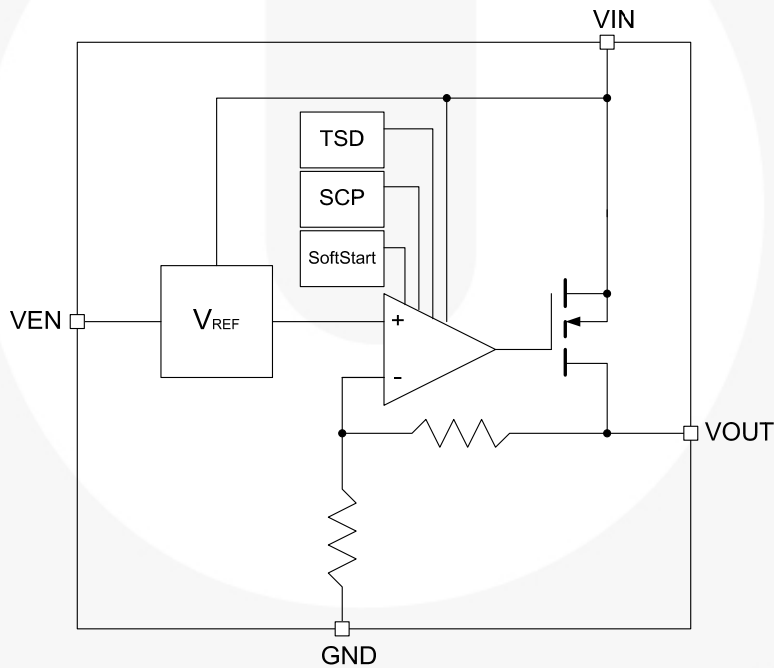

Figure 2. Block Diagram

Pin Configuration

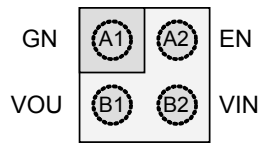

Figure 3. WLCSP Bumps Facing Down

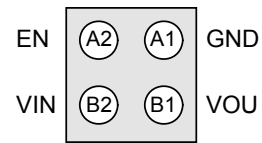

Figure 4. WLCSP, Bumps Facing Up

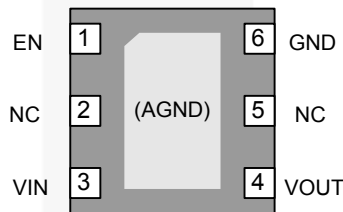

Figure 5. UMLP, Leads Facing Down

Pin Definitions

Pin #		Name	Description
WLCSP	UMLP		
A1	6	GND	Ground. Power and IC ground. All signals are referenced to this pin.
B1	4	VOUT	V_{OUT}. Connect to output voltage.
B2	3	VIN	Input Voltage. Connect to input power source.
A2	1	EN	Enable. The device is in shutdown mode when voltage to this pin is $<0.4V$ and enabled when $>0.95V$.
	5	NC	No connect.
	2	NC	No connect.

Absolute Maximum Ratings

Stresses exceeding the absolute maximum ratings may damage the device. The device may not function or be operable above the recommended operating conditions and stressing the parts to these levels is not recommended. In addition, extended exposure to stresses above the recommended operating conditions may affect device reliability. The absolute maximum ratings are stress ratings only.

Symbol	Parameter	Min.	Max.	Unit	
V_{IN}	Input Voltage with Respect to GND	-0.3	4.5	V	
	Voltage on Any Other Pin with Respect to GND	-0.3	V_{IN}	V	
T_J	Junction Temperature	-40	+150	°C	
T_{STG}	Storage Temperature	-65	+150	°C	
T_L	Lead Temperature (Soldering 10 Seconds)		+260	°C	
ESD	Electrostatic Discharge Protection Level	Human Body Model per JESD22-A114	4		kV
		Charged Device Model per JESD22-C101	2		
		Machine Model per JESD22-A115	200		V

Recommended Operating Conditions

The Recommended Operating Conditions table defines the conditions for actual device operation. Recommended operating conditions are specified to ensure optimal performance to the datasheet specifications. Fairchild does not recommend exceeding them or designing to Absolute Maximum Ratings.

Symbol	Parameter	Min.	Typ.	Max.	Unit
V_{CC}	Supply Voltage Range	1.8		3.6	V
I_{OUT}	Output Current	0		300	mA
C_{IN}	Input Capacitor		1.0		μ F
C_{OUT}	Output Capacitor	1.0	4.7	10.0	μ F
T_A	Operating Ambient Temperature	-40		+85	°C
T_J	Operating Junction Temperature	-40		+125	°C

Thermal Properties

Symbol	Parameter	Min.	Typ.	Max.	Units
Θ_{JA}	Junction-to-Ambient Thermal Resistance ⁽²⁾	WLSCP		200	°C/W
		UMLP		49	°C/W

Note:

- Junction-to-ambient thermal resistance is a function of application and board layout. This data is measured with four-layer 2s2p boards in accordance to JESD51- JEDEC standard. Special attention must be paid not to exceed junction temperature $T_{J(max)}$ at a given ambient temperature T_A .

Electrical Characteristics

$V_{IN}^{(3)} = V_{OUT} + 0.5V$ or $1.8V$ (whichever is higher). $T_A = -40^\circ C$ to $+85^\circ C$, test circuit is Figure 1, typical values are at $T_A = 25^\circ C$, $I_{LOAD} = 1mA$, $V_{EN} = V_{IN}$, unless otherwise noted.

Symbol	Parameter	Conditions	Min.	Typ.	Max.	Units
Power Supplies						
V_{IN}	Input Voltage Range		1.65		3.60	V
I_{GND}	Ground Current	$I_{LOAD} = 0mA$		45	75	μA
		$I_{LOAD} = 300mA$		140	200	μA
I_{SD}	Shutdown Supply Current	$V_{IN} = 3.6V$, $EN = GND$		0.01	1.00	μA
$V_{(EN)}$	Enable High-level Input Voltage		0.95			V
	Enable Low-level Input Voltage				0.4	
$I_{(EN)}$	Enable Input Leakage Current	$EN = GND$		0		
		$EN = V_{IN} = 3.6V$		2.5	4.0	μA
Regulation						
I_{OUT}	Minimum Output Current		0			mA
I_{OUT}	Maximum Output Current		300			mA
V_{DO}	Dropout Voltage ⁽⁴⁾	$I_{LOAD} = 300mA$		100	160	mV
ΔV_{OUT}	Output Voltage Accuracy	1.8V, 2.5V	Over Full V_{IN} , I_{OUT} , at Room Temperature	-1.0	1.0	%
		1.2V, 1.3V, 1.5V		-1.5	1.5	
		1.2V, 1.3V, 1.5V, 1.8V, 2.5V	Over Full V_{IN} , I_{OUT} , Temperature Range	-2.5	2.5	
$\Delta V_{OUTline}$	Line Regulation	$V_{IN} = V_{OUT(NOM)} + 0.5V$ to $3.6V$, $I_{OUT} = 1mA$		0.03	0.50	%/V
$\Delta V_{OUTload}$	Load Regulation	$I_{OUT} = 1mA$ to $300mA$		10	60	$\mu V/mA$
I_{SCP}	Short-circuit Current Limit			500	900	mA
I_{SU}	Start-up Peak Current	EN Transition, LOW to HIGH		500	900	mA
t_{ON}	Turn-on Time ⁽⁵⁾	EN Transition, LOW to HIGH		100		μs
	Startup Overshoot ⁽⁵⁾	$I_{OUT} = 1mA$		0		%
TSD	Thermal Shutdown	Rising Temperature		+160		$^\circ C$
		Hysteresis		+30		$^\circ C$
PSRR	Power Supply Rejection Ratio ⁽⁵⁾	$f = 1kHz$		60		dB
e_n	Output Noise Voltage ⁽⁵⁾	10Hz to 100kHz		100		μV_{RMS}
Timing Characteristics						
Peak $\Delta V_{OUTline}$	Line Transient Response ⁽⁵⁾	600mV, $t_{RISE} = t_{FALL} = 30\mu s$		± 6		mV
Peak $\Delta V_{OUTload}$	Load Transient Response ⁽⁵⁾	1mA-300mA-1mA, $t_{RISE} = t_{FALL} = 1\mu s$		± 50		mV

Note:

- V_{IN} voltage tolerance +/- 5%.
- Dropout voltage is the minimum input to output differential voltage needed to maintain V_{OUT} to within 5% of nominal value. This parameter is only specified for output voltages greater than or equal to 1.8V.
- This electrical specification is guaranteed by design.

Typical Performance Characteristics

Unless otherwise noted, $V_{IN} = V_{OUT(Nominal)} + 0.5V$ or $1.8V$ (whichever is greater), $V_{OUT} = 1.2V$, $C_{IN} = 1\mu F$, $C_{OUT} = 4.7\mu F$, and $T_A = 25^\circ C$.

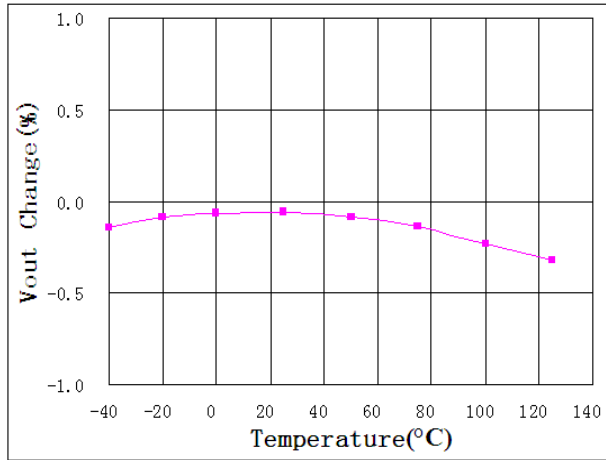

Figure 6. Output Voltage Change vs. Temperature

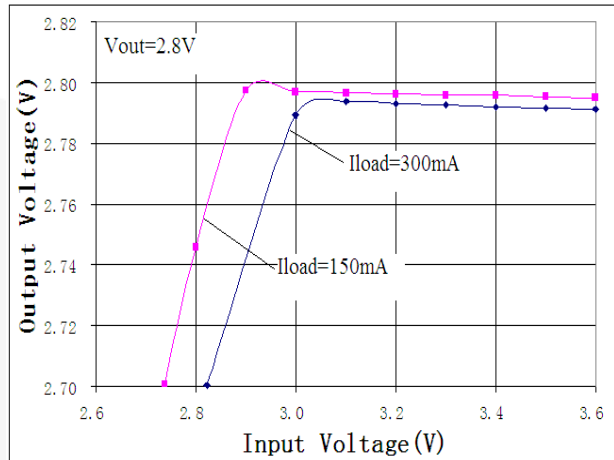

Figure 7. Output Voltage vs. Minimum Input Voltage

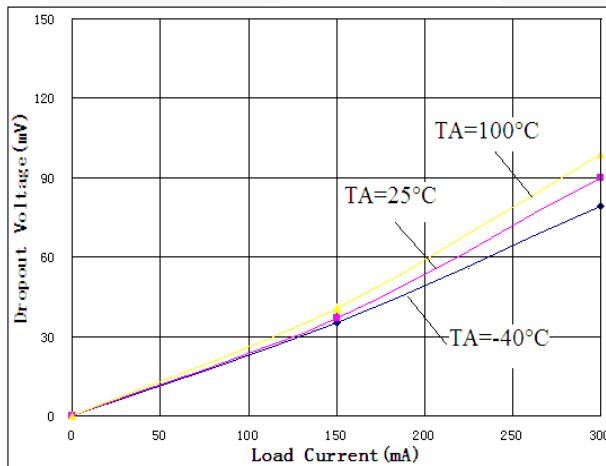

Figure 8. Dropout Voltage

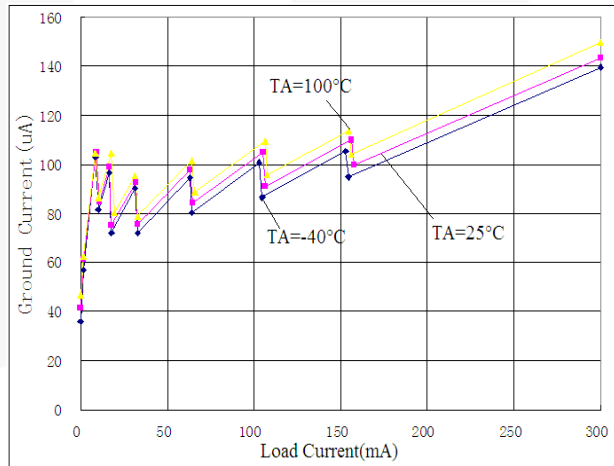

Figure 9. Ground Current vs. Load Current

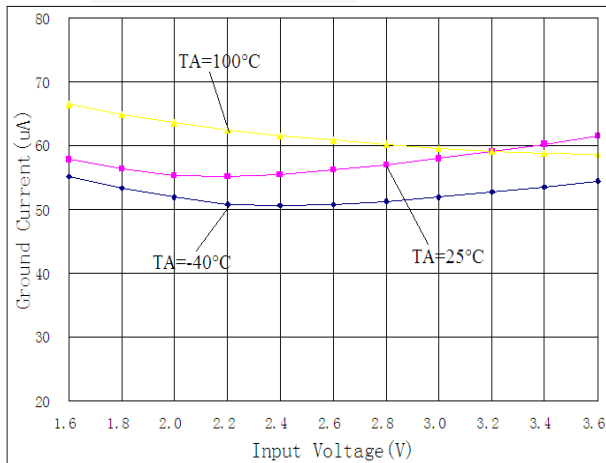

Figure 10. Ground Current vs. V_{IN} , $I_{LOAD} = 1mA$

Typical Performance Characteristics

Unless otherwise noted, $V_{IN} = V_{OUT(Nominal)} + 0.5V$ or $1.8V$ (whichever is greater), $V_{OUT} = 1.2V$, $C_{IN} = 1\mu F$, $C_{OUT} = 4.7\mu F$, and $T_A = 25^\circ C$.

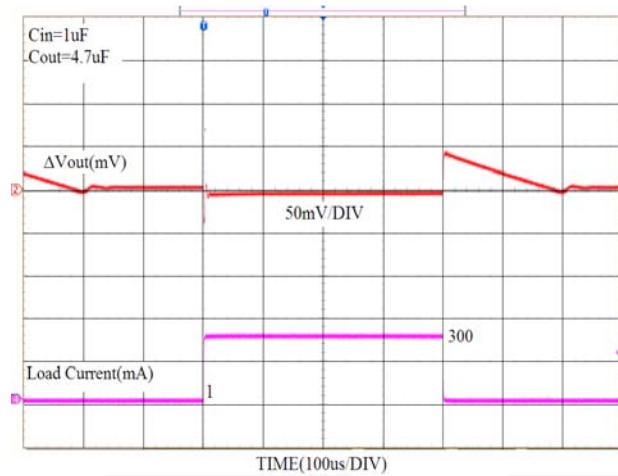

Figure 11. Load Transient, $V_{OUT} = 1.2V$

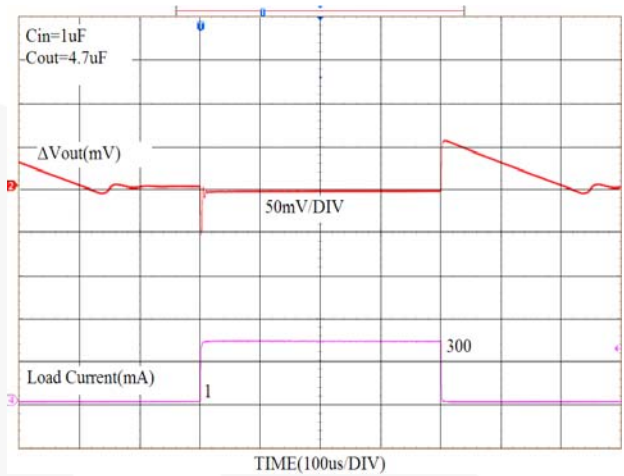

Figure 12. Load Transient, $V_{OUT} = 2.8V$

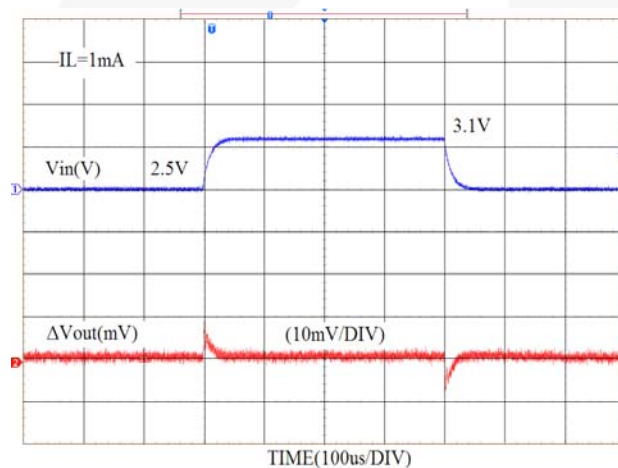

Figure 13. Line Transient, $I_{LOAD} = 1mA$

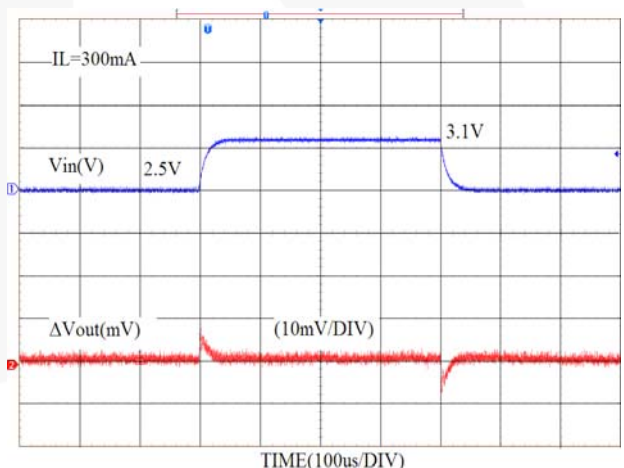

Figure 14. Line Transient, $I_{LOAD} = 300mA$

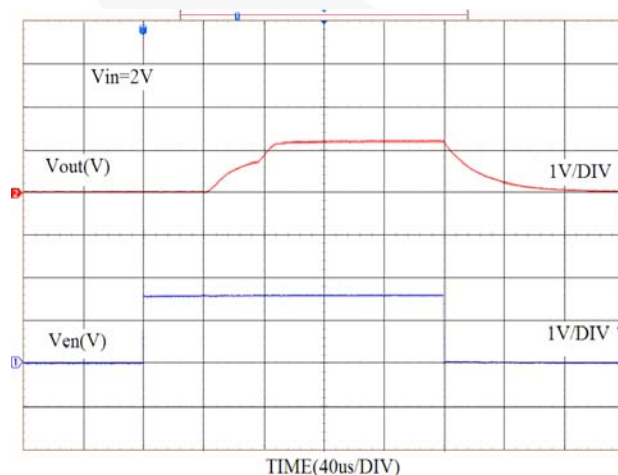

Figure 15. Enable Characteristics

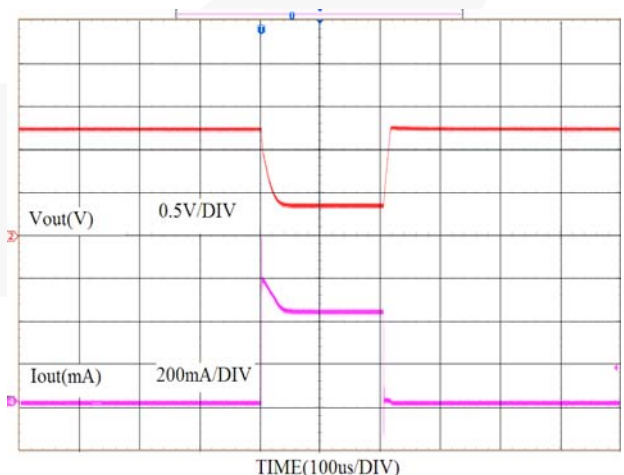

Figure 16. Short Circuit Current

Typical Performance Characteristics

Unless otherwise noted, $V_{IN}=V_{OUT(Nominal)}+0.5V$ or $1.8V$ (whichever is greater), $V_{OUT}=1.2V$, $C_{IN}=1\mu F$, $C_{OUT}=4.7\mu F$, and $T_A=25^\circ C$.

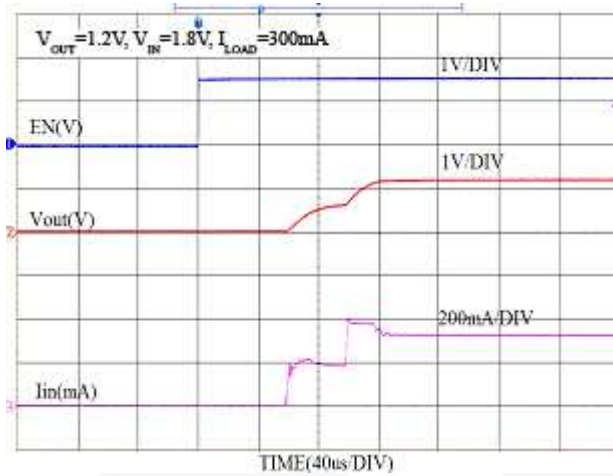

Figure 17. Inrush Current

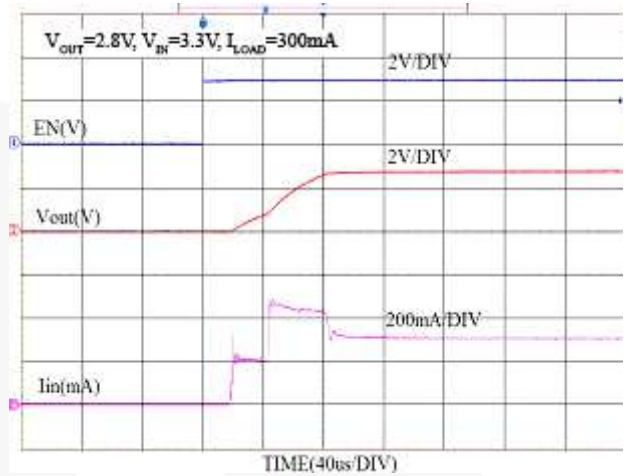

Figure 18. Inrush Current

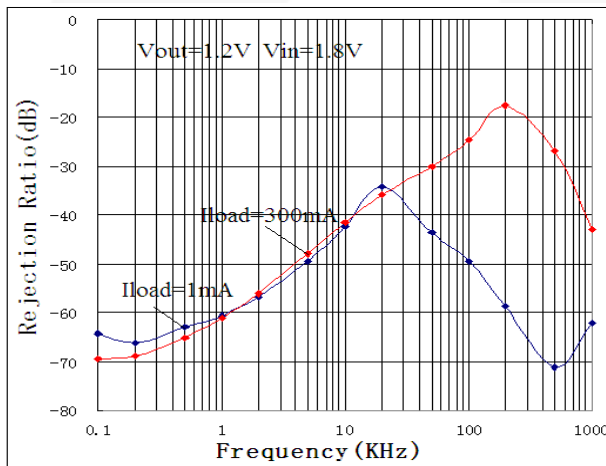

Figure 19. Power Supply Rejection Ratio

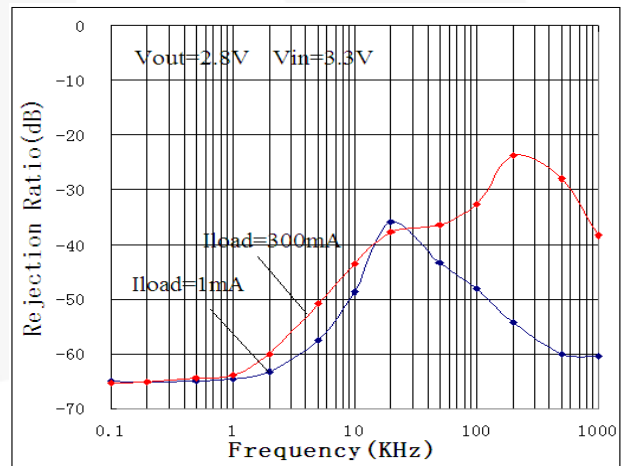

Figure 20. Power Supply Rejection Ratio

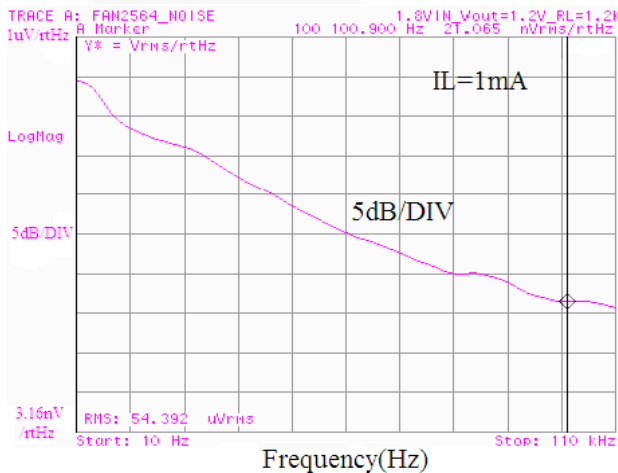

Figure 21. Noise Density

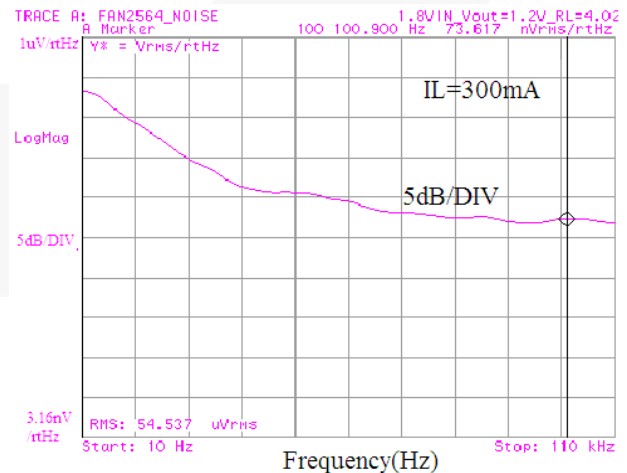

Figure 22. Noise Density

Application Information

Enable and Soft Start

A 1.4 M Ω pull-down resistor ensures the EN pin to be in LOW state when it is floating. The chip is in shut-down mode when EN pin is LOW.

To enable the chip, the EN pin needs to be raised higher than 0.95V. The output pin starts to charge up to the final voltage. On-chip soft-start circuitry limits the peak inrush current through VIN pin to less than the specified typical value of 500mA, regardless of C_{OUT} value and load conditions.

The startup time increases as V_{OUT}, C_{OUT}, and load increases, but meets the specified 100 μ s under the worst load and V_{OUT} conditions.

Short-Circuit and Thermal Protection

The output current is short-circuit protected. When a short-circuit fault occurs, the output current is automatically limited and V_{OUT} drops, depending on the actual short-circuit resistance.

Short-circuit fault or output overload may cause the die temperature to increase and exceed maximum ratings due to power dissipation. In such cases, depending upon the ambient temperature; V_{IN}, load current, and the junction-to-air thermal resistance (θ_{JA}) of the die; the device may enter thermal shutdown.

When the die temperature exceeds the shutdown limit temperature, the onboard thermal protection disables the output until the temperature drops below its hysteresis value, at which point the output is re-enabled and a new soft-start sequence occurs as described above.

Thermal Considerations

For best performance, the die temperature and the power dissipated should be kept at moderate values. The maximum power dissipated can be evaluated based on the following relationship:

$$P_{D(max)} = \left\{ \frac{T_{J(max)} - T_A}{\Theta_{JA}} \right\} \quad (1)$$

where T_{J(max)} is the maximum allowable junction temperature of the die and T_A is the ambient operating temperature. θ_{JA} is dependent on the surrounding PCB layout and can be improved by providing a heat sink of surrounding copper ground.

The addition of backside copper with through-holes, stiffeners, and other enhancements can also aid in reducing θ_{JA} . The heat contributed by the dissipation of other devices located nearby must be included in design considerations.

Capacitors Selection

The FAN2564 is stable with a wide range of capacitor values and sizes.

For loop stability, a 1 μ F input capacitor or bigger is recommended. Tolerance, temperature, and voltage coefficients of the capacitor must be considered to ensure effective capacitance stays around 1 μ F or above. There is no special requirement on its ESR value.

An output capacitor with an effective capacitance between 1 μ F and 10 μ F is required for loop stability. The ESR value should be within 5 to 100m Ω . 2.2 μ F or 4.7 μ F ceramic capacitors are recommended to ensure stability over the full temperature, input, and output voltage range of operation, such as those listed in Table 1.

Table 1. Recommended Capacitors

Capacitance	Size	Vendor	Part Number
1 μ F	0603	MURATA	GRM188R71C105KA120
2.2 μ F	0603	MURATA	GRM188R61A225KF340
2.2 μ F	0402	MURATA	GRM155R60J225ME15
4.7 μ F	0603	MURATA	GRM188C80G475KE19
4.7 μ F	0402	MURATA	GRM155R60G475M

Layout Considerations

C_{IN} and C_{OUT} should be placed close to the device for optimal transient response and device behavior. A dedicated ground plane is recommended for proper GND connection.

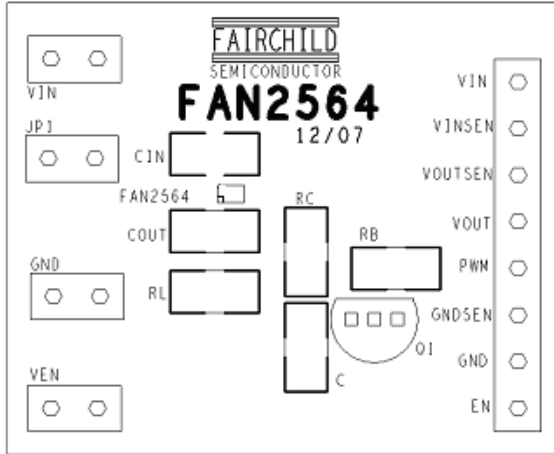

Figure 23. Assembly Diagram

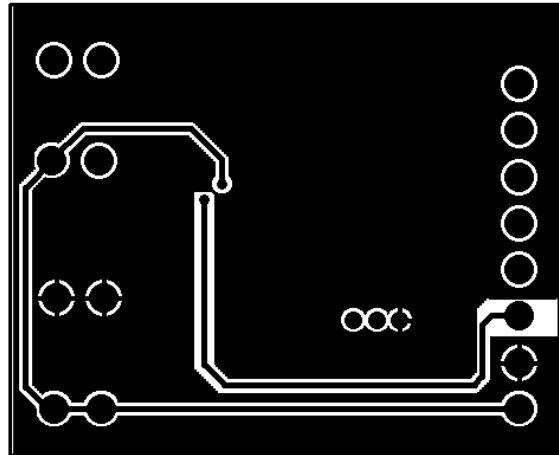

Figure 25. Bottom Layer

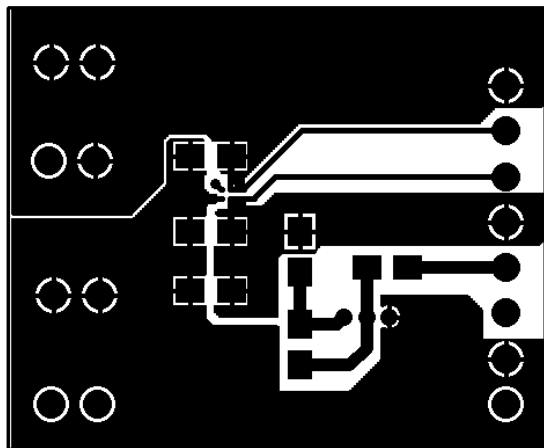

Figure 24. Top Layer



Physical Dimensions

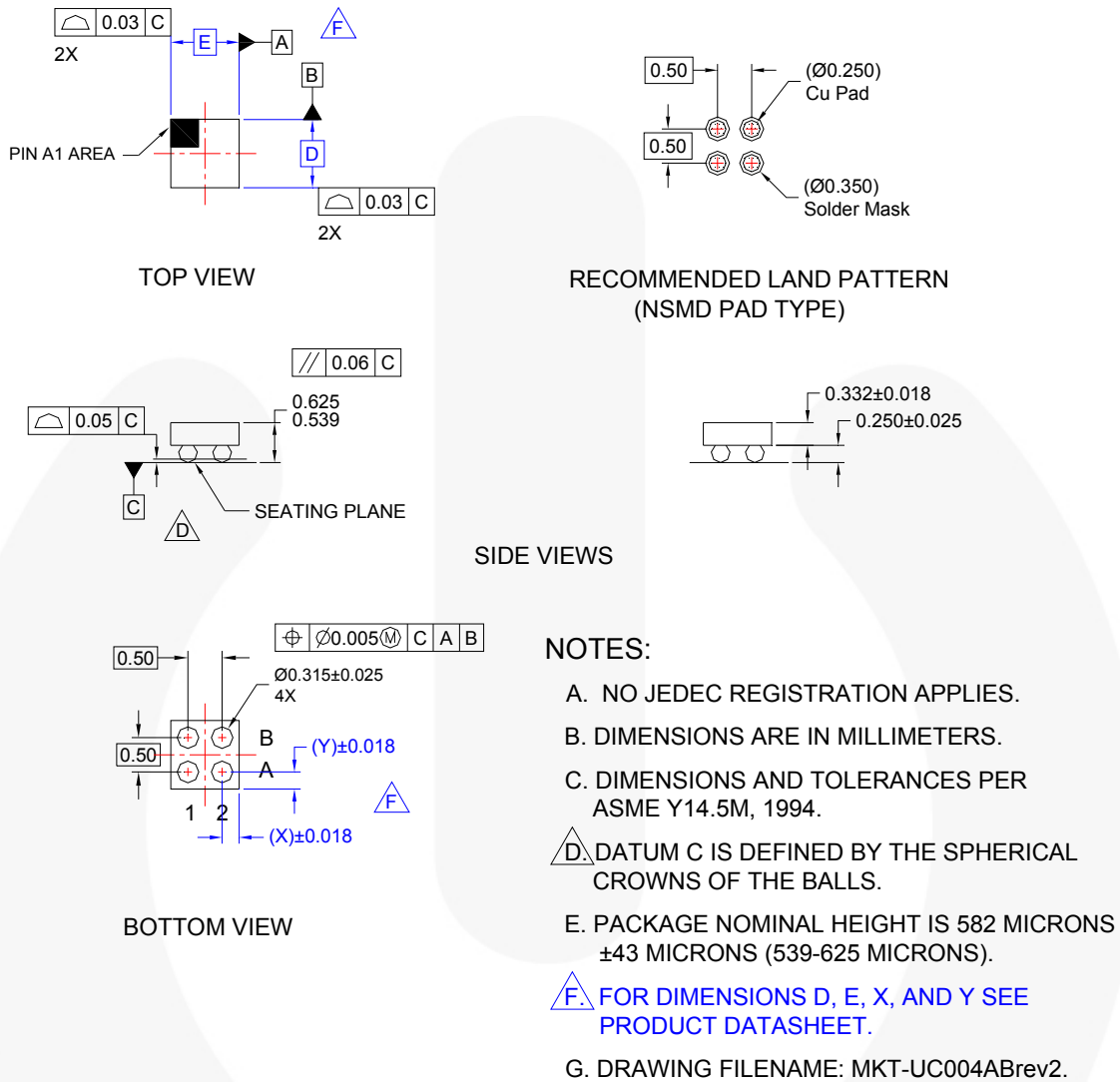

Figure 26. 4-Bump, Wafer-Level Chip-Scale Package (WLCSP), 0.5mm Pitch

Product Specific Dimensions

Product	D	E	X	Y
FAN2564UCX	1.41 +/-0.030	0.93 +/-0.030	0.215	0.455

Package drawings are provided as a service to customers considering Fairchild components. Drawings may change in any manner without notice. Please note the revision and/or date on the drawing and contact a Fairchild Semiconductor representative to verify or obtain the most recent revision. Package specifications do not expand the terms of Fairchild's worldwide terms and conditions, specifically the warranty therein, which covers Fairchild products.

Always visit Fairchild Semiconductor's online packaging area for the most recent package drawings:
<http://www.fairchildsemi.com/packaging/>.

Physical Dimensions

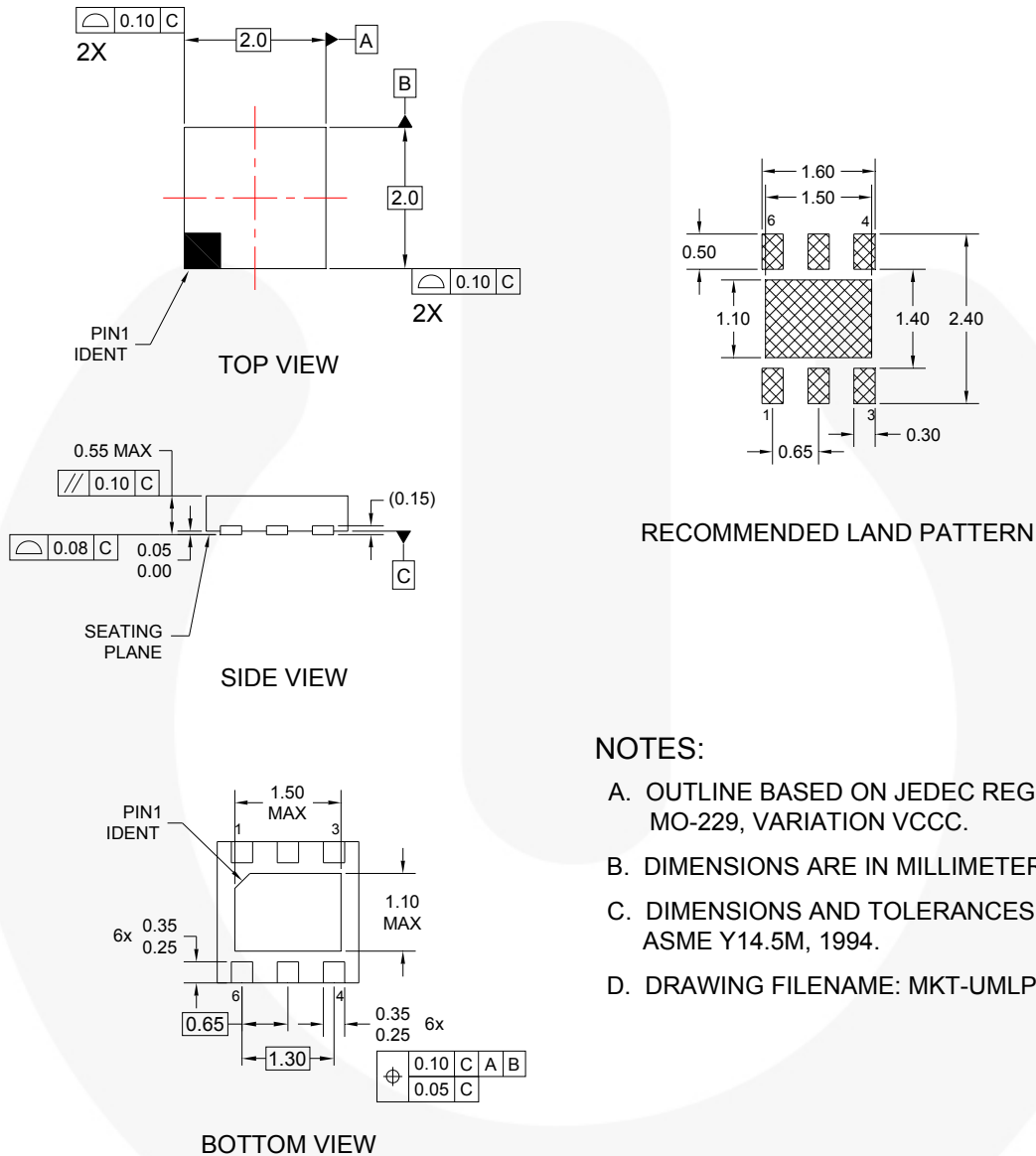

Figure 27. 6-Pin, Ultrathin Molded Leadless Package (UMLP)



Package drawings are provided as a service to customers considering Fairchild components. Drawings may change in any manner without notice. Please note the revision and/or date on the drawing and contact a Fairchild Semiconductor representative to verify or obtain the most recent revision. Package specifications do not expand the terms of Fairchild's worldwide terms and conditions, specifically the warranty therein, which covers Fairchild products.

Always visit Fairchild Semiconductor's online packaging area for the most recent package drawings:
<http://www.fairchildsemi.com/packaging/>.



TRADEMARKS

The following includes registered and unregistered trademarks and service marks, owned by Fairchild Semiconductor and/or its global subsidiaries, and is not intended to be an exhaustive list of all such trademarks.

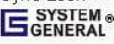
AccuPower™	F-PFS™	Power-SPM™	The Power Franchise®
Auto-SPM™	FRFET®	PowerTrench®	The Right Technology for Your Success™
AX-CAP™*	Global Power Resource™	PowerXS™	the power franchise
Build it Now™	Green FPST™	Programmable Active Droop™	TinyBoost™
CorePLUS™	Green FPST™ e-Series™	QFET®	TinyBuck™
CorePOWER™	Gmax™	QS™	TinyCalc™
CROSSVOLT™	GTO™	Quiet Series™	TinyLogic®
CTL™	IntelliMAX™	RapidConfigure™	TINYOPTO™
Current Transfer Logic™	ISOPLANAR™		TinyPower™
DEUXPEED®	MegaBuck™	Saving our world, 1mW/kW at a time™	TinyPVM™
Dual Cool™	MICROCOUPLER™	SignalWise™	TinyWire™
EcoSPARK®	MicroFET™	SmartMax™	TriFault Detect™
EfficientMax™	MicroPak™	SMART START™	TRUECURRENT®*
ESBC™	MicroPak2™	SPM®	µSerDes™
F ®	MillerDrive™	STEALTH™	
Fairchild®	MotionMax™	SuperFET®	UHC®
Fairchild Semiconductor®	Motion-SPM™	SuperSOT™-3	Ultra FRFET™
FACT Quiet Series™	mWSaver™	SuperSOT™-6	UniFET™
FACT®	OptoHIT™	SuperSOT™-8	VCM™
FAST®	OPTOLOGIC®	SupreMOS®	VisualMax™
FastvCore™	OPTOPLANAR®	SyncFET™	XS™
FETBench™		Sync-Lock™	
FlashWriter®*	PDP SPM™		
FPS™			

* Trademarks of System General Corporation, used under license by Fairchild Semiconductor.

DISCLAIMER

FAIRCHILD SEMICONDUCTOR RESERVES THE RIGHT TO MAKE CHANGES WITHOUT FURTHER NOTICE TO ANY PRODUCTS HEREIN TO IMPROVE RELIABILITY, FUNCTION, OR DESIGN. FAIRCHILD DOES NOT ASSUME ANY LIABILITY ARISING OUT OF THE APPLICATION OR USE OF ANY PRODUCT OR CIRCUIT DESCRIBED HEREIN; NEITHER DOES IT CONVEY ANY LICENSE UNDER ITS PATENT RIGHTS, NOR THE RIGHTS OF OTHERS. THESE SPECIFICATIONS DO NOT EXPAND THE TERMS OF FAIRCHILD'S WORLDWIDE TERMS AND CONDITIONS, SPECIFICALLY THE WARRANTY THEREIN, WHICH COVERS THESE PRODUCTS.

LIFE SUPPORT POLICY

FAIRCHILD'S PRODUCTS ARE NOT AUTHORIZED FOR USE AS CRITICAL COMPONENTS IN LIFE SUPPORT DEVICES OR SYSTEMS WITHOUT THE EXPRESS WRITTEN APPROVAL OF FAIRCHILD SEMICONDUCTOR CORPORATION.

As used herein:

1. Life support devices or systems are devices or systems which, (a) are intended for surgical implant into the body or (b) support or sustain life, and (c) whose failure to perform when properly used in accordance with instructions for use provided in the labeling, can be reasonably expected to result in a significant injury of the user.
2. A critical component in any component of a life support, device, or system whose failure to perform can be reasonably expected to cause the failure of the life support device or system, or to affect its safety or effectiveness.

ANTI-COUNTERFEITING POLICY

Fairchild Semiconductor Corporation's Anti-Counterfeiting Policy. Fairchild's Anti-Counterfeiting Policy is also stated on our external website, www.fairchildsemi.com, under Sales Support.

Counterfeiting of semiconductor parts is a growing problem in the industry. All manufacturers of semiconductor products are experiencing counterfeiting of their parts. Customers who inadvertently purchase counterfeit parts experience many problems such as loss of brand reputation, substandard performance, failed applications, and increased cost of production and manufacturing delays. Fairchild is taking strong measures to protect ourselves and our customers from the proliferation of counterfeit parts. Fairchild strongly encourages customers to purchase Fairchild parts either directly from Fairchild or from Authorized Fairchild Distributors who are listed by country on our web page cited above. Products customers buy either from Fairchild directly or from Authorized Fairchild Distributors are genuine parts, have full traceability, meet Fairchild's quality standards for handling and storage and provide access to Fairchild's full range of up-to-date technical and product information. Fairchild and our Authorized Distributors will stand behind all warranties and will appropriately address any warranty issues that may arise. Fairchild will not provide any warranty coverage or other assistance for parts bought from Unauthorized Sources. Fairchild is committed to combat this global problem and encourage our customers to do their part in stopping this practice by buying direct or from authorized distributors.

PRODUCT STATUS DEFINITIONS

Definition of Terms

Datasheet Identification	Product Status	Definition
Advance Information	Formative / In Design	Datasheet contains the design specifications for product development. Specifications may change in any manner without notice.
Preliminary	First Production	Datasheet contains preliminary data; supplementary data will be published at a later date. Fairchild Semiconductor reserves the right to make changes at any time without notice to improve design.
No Identification Needed	Full Production	Datasheet contains final specifications. Fairchild Semiconductor reserves the right to make changes at any time without notice to improve the design.
Obsolete	Not In Production	Datasheet contains specifications on a product that is discontinued by Fairchild Semiconductor. The datasheet is for reference information only.

Rev. 153