



Chipsmall Limited consists of a professional team with an average of over 10 year of expertise in the distribution of electronic components. Based in Hongkong, we have already established firm and mutual-benefit business relationships with customers from,Europe,America and south Asia,supplying obsolete and hard-to-find components to meet their specific needs.

With the principle of "Quality Parts,Customers Priority,Honest Operation,and Considerate Service",our business mainly focus on the distribution of electronic components. Line cards we deal with include Microchip,ALPS,ROHM,Xilinx,Pulse,ON,Everlight and Freescale. Main products comprise IC,Modules,Potentiometer,IC Socket,Relay,Connector.Our parts cover such applications as commercial,industrial, and automotives areas.

We are looking forward to setting up business relationship with you and hope to provide you with the best service and solution. Let us make a better world for our industry!



## Contact us

Tel: +86-755-8981 8866 Fax: +86-755-8427 6832

Email & Skype: info@chipsmall.com Web: www.chipsmall.com

Address: A1208, Overseas Decoration Building, #122 Zhenhua RD., Futian, Shenzhen, China





Is Now Part of



**ON Semiconductor®**

To learn more about ON Semiconductor, please visit our website at  
[www.onsemi.com](http://www.onsemi.com)

ON Semiconductor and the ON Semiconductor logo are trademarks of Semiconductor Components Industries, LLC dba ON Semiconductor or its subsidiaries in the United States and/or other countries. ON Semiconductor owns the rights to a number of patents, trademarks, copyrights, trade secrets, and other intellectual property. A listing of ON Semiconductor's product/patent coverage may be accessed at [www.onsemi.com/site/pdf/Patent-Marking.pdf](http://www.onsemi.com/site/pdf/Patent-Marking.pdf). ON Semiconductor reserves the right to make changes without further notice to any products herein. ON Semiconductor makes no warranty, representation or guarantee regarding the suitability of its products for any particular purpose, nor does ON Semiconductor assume any liability arising out of the application or use of any product or circuit, and specifically disclaims any and all liability, including without limitation special, consequential or incidental damages. Buyer is responsible for its products and applications using ON Semiconductor products, including compliance with all laws, regulations and safety requirements or standards, regardless of any support or applications information provided by ON Semiconductor. "Typical" parameters which may be provided in ON Semiconductor data sheets and/or specifications can and do vary in different applications and actual performance may vary over time. All operating parameters, including "Typicals" must be validated for each customer application by customer's technical experts. ON Semiconductor does not convey any license under its patent rights nor the rights of others. ON Semiconductor products are not designed, intended, or authorized for use as a critical component in life support systems or any FDA Class 3 medical devices or medical devices with a same or similar classification in a foreign jurisdiction or any devices intended for implantation in the human body. Should Buyer purchase or use ON Semiconductor products for any such unintended or unauthorized application, Buyer shall indemnify and hold ON Semiconductor and its officers, employees, subsidiaries, affiliates, and distributors harmless against all claims, costs, damages, and expenses, and reasonable attorney fees arising out of, directly or indirectly, any claim of personal injury or death associated with such unintended or unauthorized use, even if such claim alleges that ON Semiconductor was negligent regarding the design or manufacture of the part. ON Semiconductor is an Equal Opportunity/Affirmative Action Employer. This literature is subject to all applicable copyright laws and is not for resale in any manner.



# FAN41501

## Ground Fault Interrupter Self-Test Digital Controller

### Features

- Meets 2015 UL943 Self-Test GFCI Requirement
- Internal 1-Second and 90-Minute Self-Test Timers
- Periodic Functional Testing for Key GFIC Components: GFCI Controller, Solenoid, Sense Transformer, and Silicon-Controlled Rectifier (SCR)
- Periodic EOL Testing without Compromising Normal GFCI Protection
- Built-in Noise Filters Reduce False EOL Signals
- Automatic EOL Reset Capability
- Easily Added to Existing GFCI Applications
- Built-in 5 V Shunt Regulator
- Energy-Saving System Solution
- Minimum External Components
- Space-Saving SuperSOT™ 6-Pin Package

### Applications

- GFCI Output Receptacle
- GFCI Circuit Breakers
- Portable GFCI Cords

### Description

The FAN41501 is a digital controller for periodic functional testing of key Ground Fault Circuit Interrupters (GFCI) components. In combination with an existing Fairchild GFI controller, it periodically tests for the functional operation of the GFCI controller, solenoid, sense transformer, SCR, and other discrete components without disrupting power to the load or compromising normal GFCI protection functionality. If the FAN41501 detects a faulty GFCI component, it generates an End-of-Life (EOL) fault signal that can be used to deny power and/or automatically reset after the denial of power.

When the AC power is first applied, an internal timer starts a test cycle at one second. After this initial test cycle, the internal timer starts a test cycle every 90 minutes. During a test cycle, the FAN41501 simulates a ground fault and monitors the key GFCI components. If the FAN41501 detects a component fault, it verifies the fault several times to prevent a false EOL signal. At no time during a test cycle is the normal GFCI protection disabled or compromised.

The FAN41501 includes a 5 V shunt regulator, one-second timer, 90-minute timer, digital control logic, detection comparators, and an EOL driver output.

The FAN41501, together with a GFCI controller such as FAN4149, provides a complete UL943 GFCI function with automatic monitoring capability, low system power, and a minimum number of external components.

The 6-pin, SuperSOT™ package enables a low-cost, compact design and layout.

### Ordering Information

Part Number	Operating Temperature Range	Package	Packing Method
FAN41501SX	-35°C to +85°C	6-Lead, SuperSOT™, JEDEC M0-193, 1.6 mm	Tape and Reel

## Typical Application

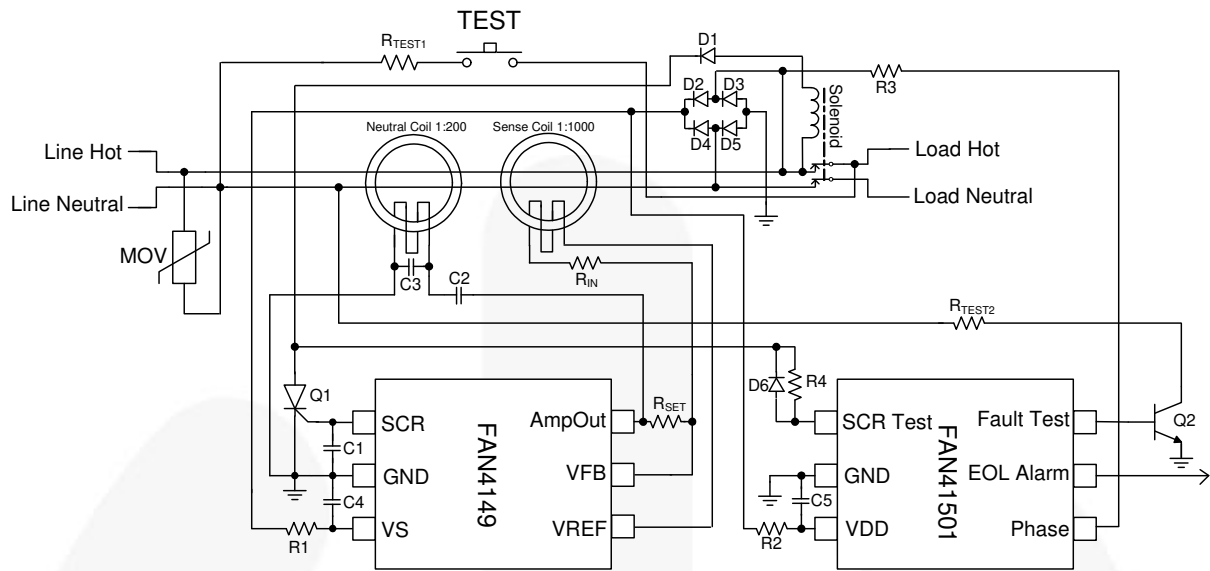


Figure 1. Typical Application<sup>(1,2)</sup>

Table 1. Typical Values<sup>(3)</sup>

R1: 75 k $\Omega$	R2: 75 k $\Omega$	R3: 1 M $\Omega$	R4: 909 k $\Omega$
R <sub>SET</sub> : 750 k $\Omega$ <sup>(4)</sup>	R <sub>IN</sub> : 470 $\Omega$	R <sub>Test1</sub> : 15 k $\Omega$	R <sub>Test2</sub> : 10 k $\Omega$
C1: 22 nF	C2: 10 nF	C3: 5.6 nF	C4: 220 nF
			C5: 1 $\mu$ F

### Notes:

1. Contact Fairchild Semiconductor for self-test requirement details.
2. Portions of this schematic are subject to U.S. patents 8,085,516 and 8,760,824.
3. XMFR: Magnetic Metals 5029/F3006.
4. Value depends on sense coil characteristics and application.

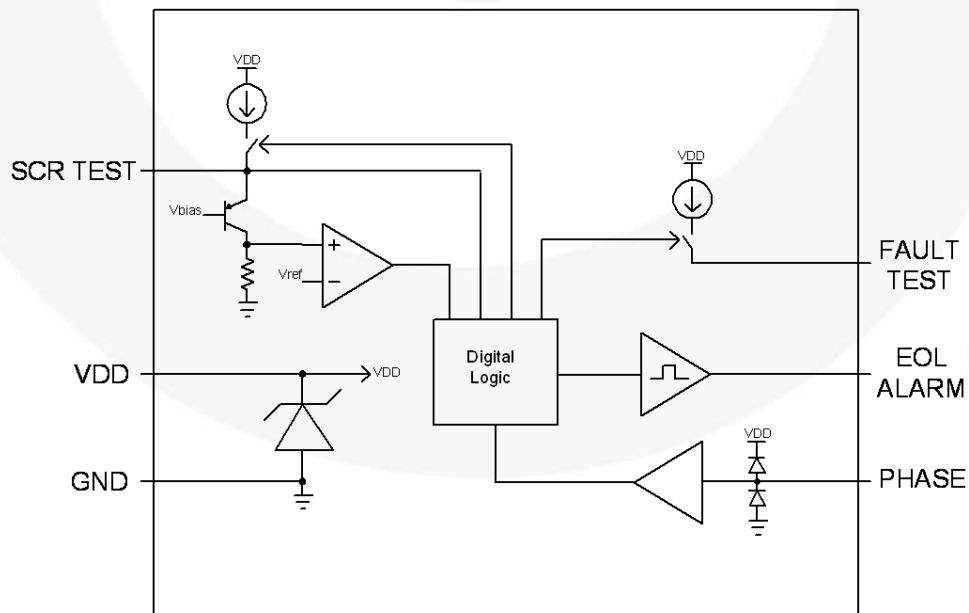


Figure 2. Block Diagram

### Pin Configuration

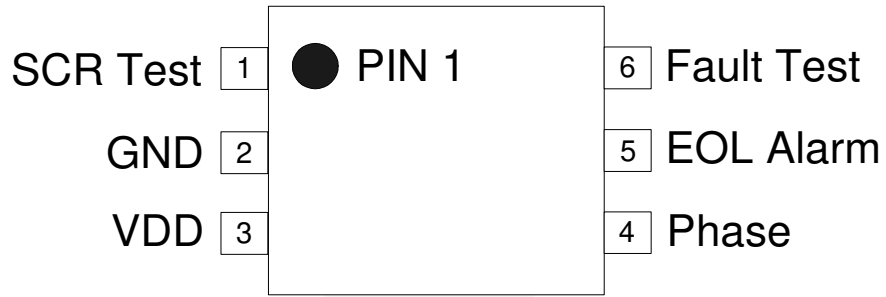


Figure 3. Pin Assignments

### Pin Definitions

Pin #	Name	Description
1	SCR Test	SCR test input for SCR functionality
2	GND	Ground for FAN41501 circuitry
3	VDD	Voltage supply input for FAN41501 circuitry
4	Phase	Phase input for $V_{AC}$ frequency
5	EOL Alarm	Alarm for end-of-life signal
6	Fault Test	Fault test output signal for ground-fault simulation

## Absolute Maximum Ratings

Stresses exceeding the absolute maximum ratings may damage the device. The device may not function or be operable above the recommended operating conditions and stressing the parts to these levels is not recommended. In addition, extended exposure to stresses above the recommended operating conditions may affect device reliability. The absolute maximum ratings are stress ratings only.

Symbol	Parameter	Condition	Min.	Max.	Unit
$I_{CC}$	Supply Current	Continuous Current, VDD to GND		10	mA
$V_{CC}$	Supply Voltage	Continuous Voltage, VDD to GND	-0.8	7.0	V
		Continuous Voltage to Neutral, All Other Pins	-0.8	7.0	V
$T_{STG}$	Storage Temperature Range		-65	+150	°C
ESD	Electrostatic Discharge Capability	Human Body Model, ANSI / ESDA / JEDEC JS-001-2012		2.5	kV
		Charged Device Model, JESD22-C101		1.0	

## Recommended Operating Conditions

The Recommended Operating Conditions table defines the conditions for actual device operation. Recommended operating conditions are specified to ensure optimal performance to the data sheet specifications. Fairchild does not recommend exceeding them or designing to Absolute Maximum Ratings. Unless otherwise specified, refer to Figure 1.  $T_A=25^{\circ}\text{C}$ ,  $I_{SHUNT}=1\text{ mA}$ , and phase=60 Hz.

Symbol	Parameter	Conditions	Min.	Typ.	Max.	Unit
$V_{REG}$	Power Supply Shunt Regulator Voltage	VDD to GND	5.10	5.35	5.70	V
$V_{UVLO\_RST}$	Under-Voltage Reset	VDD to GND	2.2	2.5	2.7	V
		Rising Hysteresis		150		mV
$I_Q$	Quiescent Current	VDD to GND= 4.5 V	350	450	550	$\mu\text{A}$
$t_{FIRST}$	First Timer Period	$V_{DD} > 2.5\text{ V}$	0.812	1.016	1.220	s
$t_{PER}$	Periodic Timer	Steady State	4400	5400	6400	s
$t_{TESTOUT}$	Test Cycle Time Out	Fault Testing	54	66	78	ms
$t_{PHASE}$	Phase Continuity Check Time Out	Phase Pin Continuity Check at Startup	40	60	80	ms
$V_{PHASE\_H}$	Phase Voltage Clamp HIGH	$I_H = 170\ \mu\text{A}$	5.8	6.3	6.6	V
$V_{PHASE\_L}$	Phase Voltage Clamp LOW	$I_L = -170\ \mu\text{A}$	-0.8	-0.6	-0.4	V
$I_{PHASE\_MAX}$	Phase Maximum Current	$I_{SHUNT} = 1.5\text{ mA}$	-300		300	$\mu\text{A}$
$V_{SCR\_H}$	SCR Test Input Clamp HIGH	$I_H = 170\ \mu\text{A}$	5.0	5.4	5.8	V
$V_{SCR\_L}$	SCR Test Input Clamp LOW	$I_L = -170\ \mu\text{A}$	-0.8	-0.6	-0.4	V
$I_{SCR\_MAX}$	SCR Test Maximum Current	$I_{SHUNT} = 1.5\text{ mA}$	-300		300	$\mu\text{A}$
$I_{TEST}$	Fault Test Current	Test Cycle	400	500		$\mu\text{A}$
$V_{EOL\_L}$	EOL Alarm $V_{OL}$	No Load		0	200	mV
$V_{EOL\_H}$	EOL Alarm $V_{OH}$	No Load	4.80	5.25		V
$f_{EOL}$	EOL Alarm	Latched Fault Output	3.00	3.75	4.25	Hz
$I_{EOL}$	EOL Alarm $I_{OUT}$	$I_{SHUNT} = 2.0\text{ mA}$	1			mA

## Functional Description

(Refer to Figure 1)

Starting in June 2015, UL943 will require all permanently connected GFCI products to perform a self test function. The FAN41501, together with a GFI controller device – like the FAN4149 – provides GFI fault protection and periodic self testing of the key GFCI components: solenoid, SCR, GFI controller, sense coil, and other discrete components.

The FAN41501 has an internal 5.35 V shunt regulator. With diodes D2-5 and resistor R2, the shunt regulator clamps the FAN41501  $V_{DD}$  supply voltage to 5.35 V. Capacitor C5 provides bias during the  $V_{AC}$  zero phase crossing so the FAN41501 is continuously biased. When power is first applied, an internal Power-On-Reset (POR) circuit detects when  $V_{DD}$  is greater than 2.5 V. The POR circuit generates an internal reset pulse and initializes a one-second timer. After one second, the first self-test cycle starts. During the positive half cycle when the “line-hot” voltage is positive with respect to the “line-neutral” voltage, the SCR anode voltage is monitored by means of resistor R4 connected to pin 1 (SCR Test). The FAN41501 clamps this pin to  $V_{DD}$ , mirrors the current through R4 to an internal low-pass filter circuit, and compares its value to an internal reference threshold. When the current level exceeds the reference threshold, an internal latch is set. This test determines the continuity of the solenoid and SCR. The threshold level is determined by:

$$V_{th_{rms}} = (65 \mu A \times R4) + 4 \quad (1)$$

where  $V_{th_{rms}}$  is the rms  $V_{AC}$  input voltage with a tolerance of  $\pm 10\%$ .

With the recommended application values, the SCR anode voltage must exceed a worst-case peak voltage of approximately 65 V (rms). Equation (1) can be used if a lower threshold voltage value is desired to allow this test to pass during a brownout or voltage sag condition.

To test the functionality of the GFCI controller, sense coil, and SCR; a simulated ground fault condition is generated. Like the SCR Test pin; the Phase pin (pin 4) is clamped to  $V_{DD} + 700$  mV, mirrors the current through R3 to an internal low-pass filter circuit, and compares its value to an internal reference. This internal circuit detects when the phase signal is near the end of the positive half cycle. When this occurs, an internal current source is enabled to bias the SCR Test pin. This prevents the SCR anode voltage from discharging to zero during the negative half cycle since it is reverse-biased by diode D1. At the end of the positive half cycle, the FAN41501 generates a current pulse for the Fault Test pin (pin 6). This current pulse enables transistor Q2, which biases the collector voltage of Q2 to a low voltage. During the negative half cycle when the line-neutral voltage is positive with respect to the line-hot voltage, current flows through resistor  $R_{TEST2}$  when Q2 is enabled. This current creates a simulated ground fault from line-neutral to load hot. This current is detected by

the GFI controller (i.e. FAN4149) and, when it exceeds the programmed trip threshold set by  $R_{SET}$  (typically 5 mA<sub>rms</sub>), the controller enables the SCR Q1 (see [FAN4149 datasheet for  \$I\_{FAULT}\$  trip threshold equation](#)). The SCR quickly discharges the anode voltage, which is pre-biased by the FAN41501 control logic. The discharge of the anode voltage also biases the voltage at the SCR Test pin to a low voltage by forward-biasing diode D6. The FAN41501 monitors the SCR Test pin during this test cycle and sets a latch if the SCR is triggered. The simulated ground fault tests for the functionality of the controller, R1, D1, D2-5<sup>(5)</sup>, sense coil, and SCR without opening the load contacts. The load contacts do not open during this test because D1 is reversed biased, which prevents current from energizing the solenoid. Once the FAN41501 detects the triggering of the SCR, the current pulse for Q2 is disabled and the bias current for pin SCR Test is removed. This disables the SCR so that during the next positive half cycle the solenoid is not energized. With the recommended application values, the simulated ground fault triggers the controller with a  $V_{AC}$  input voltage greater than 50 V<sub>rms</sub>. If a different voltage threshold is required, the  $R_{TEST2}$  resistor can be adjusted (per the [FAN4149 datasheet](#)). Figure 4, Figure 5 and Figure 6 show a passing self-test cycle. The waveform of channel 4 shows when the Q2 transistor is enabled and a ground fault is simulated by the current through resistor  $R_{TEST2}$ . The channel 3 waveform shows the gate of the SCR Q1. Figure 6 shows the pre-bias for the SCR anode voltage, waveform of channel 1. Figure 6 illustrates that, when the gate of the SCR is enabled by the controller, the voltage of the SCR anode is quickly discharged. The FAN41501 detects this and a self-test cycle is completed with all of the required components passing. The Q2 bias is disabled, which causes the GFCI controller to disable the SCR gate bias.

### Note:

- Redundant diodes may be required.

If the first self-test cycle passes after power up, subsequent self-test cycles occur every 90 minutes. At no time does the FAN41501 disable the normal controller GFI protection circuitry.

If any one of the above self tests fail, the FAN41501 repeats the self testing until a 66 ms timer expires. If this occurs, the EOL latch is enabled and the FAN41501 EOL Alarm pin 5 goes HIGH. This signal can be connected to a separate SCR or to the gate of Q1 with a series diode. When the EOL Alarm goes HIGH, the SCR is enabled and energizes the solenoid, which opens the load contacts. When the EOL Alarm pin goes HIGH, if it is connected to the gate of an SCR,  $V_{DD}$  drops below 2.5 V. This generates a Power-On-Reset that resets the logic and repeats a self-test cycle in one second. Figure 7 to Figure 10 show a FAN41501 self-test cycle for a SCR, GFI controller, sense coil, and solenoid failure.

The self test cycle lasts for 66 ms to allow four self-test cycle attempts. After the timer has expired, the EOL alarm is enabled. Figure 7 to Figure 10 show an example of the EOL alarm signal connected to the gate of an SCR. When the EOL alarm signal is enabled, the  $V_{DD}$  voltage is discharged, which causes a POR. The EOL alarm is disabled and a self-test cycle is repeated in one second.

In addition to the above GFCI tests, the FAN41501 also performs a pin 4 (Phase pin) continuity check when power is first detected. When  $V_{DD}$  exceeds 2.5 V, pin 4 is checked for an open or short. If this continuity check fails after 60 ms, the EOL alarm is enabled. Figure 11 shows an example of the Phase pin with R3 removed (floating pin). After approximately 60ms, the EOL alarm is enabled.

After a self-test cycle failure, the EOL alarm is latched HIGH for 133 ms. This signal generates a repetitive 3.75 Hz digital square wave. There are two ways to reset the EOL alarm signal. The first is POR as described above, which can occur if the AC power is cycled. Since it may be undesirable to cycle the AC power, the EOL alarm signal can also be connected to the gate of a SCR or “clamp diode” to generate a POR. If the EOL alarm signal is diode clamped when the EOL alarm signal goes HIGH, a high  $I_{OH}$  current is generated. This current is dependent on R2 and C5, however; if the datasheet values are used, the typical  $I_{OH}$  peak current can be greater than 5 mA. This high current can be used to “latch on” a SCR and cause  $V_{DD}$  to drop below 2.5 V, which generates a POR. Figure 11 shows the  $V_{DD}$  signal when the EOL alarm signal is connected to the gate of a SCR with a series diode. The high EOL alarm  $I_{OH}$  current causes  $V_{DD}$  to drop below 2.5 V during the  $V_{AC}$  zero crossing.

Another way to reset the EOL alarm signal is to detect a successful manual test cycle. If the FAN41501 is latched in an EOL state and detects a “manual test” (i.e., the TEST button is pressed) the FAN41501 disables the EOL alarm and perform sa self-test cycle in one second. If an EOL alarm state has occurred due to a pin 4 continuity check failure, the “manual test” reset option is disabled.

Referring to Figure 1, the EOL alarm signal must be used to open the load contacts (power denial) if a self-test cycle fails for the tested components (with the exception for a solenoid or SCR open failure). As described above, this can be done with a redundant SCR or by connecting the EOL alarm signal to Q1 via a series diode. If Q1 is used to open the load contacts, a gate resistor must be added from the GFCI controller gate drive pin to the gate of the SCR. If Q1 or the solenoid fails due to an open circuit, a visual EOL signal can be generated instead of power denial. This can be accomplished by making the series diode from the EOL Alarm pin to the gate of Q1 a LED diode. This diode flashes every second. Additionally, an LED diode can be added in series with  $R_{TEST2}$  and the collector of Q2. This LED diode can be used to provide a self-test signal at power up and then every 90 minutes. If the self-test cycle fails, it flashes every second.

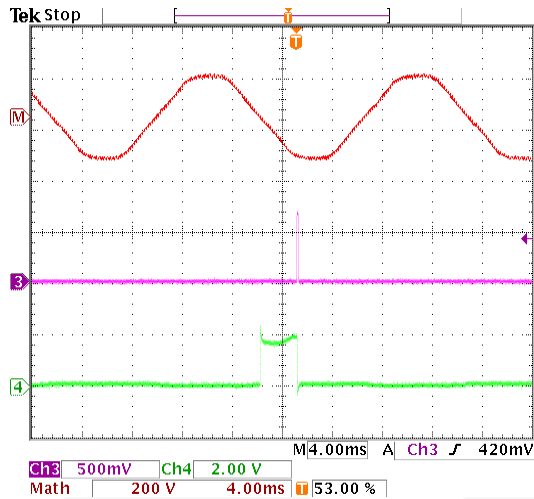
In summary, the FAN41501 can be added to an existing UL943 circuit to comply with the 2015 UL self-test requirement. The small package size and the minimum required components allow for a compact, low-cost, GFCI self-test solution.

Contact a Fairchild Semiconductor representative for details about how to test the FAN41501 self-test features in production or for details about the 2015 UL943 self-test application requirements.

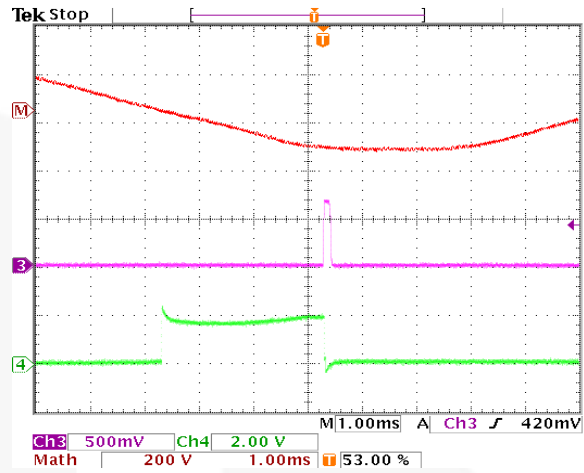


## Typical Performance Characteristics

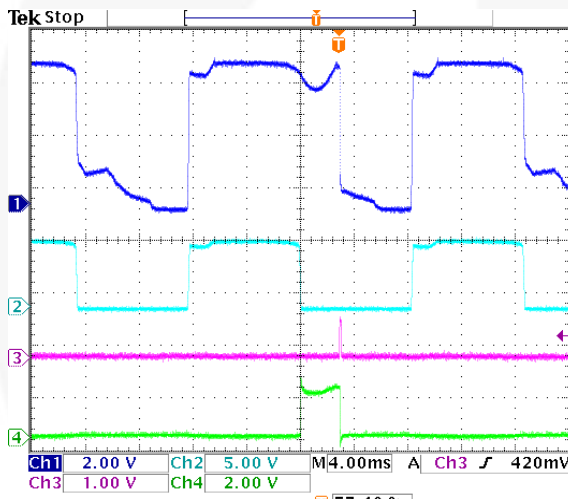
Pass testing of all key components. Refer to evaluation board (see [www.fairchildsemi.com](http://www.fairchildsemi.com) for details).



**Figure 4. Pass GFCI, Sense Coil, Solenoid, SCR Tests; Ch Math:  $V_{AC}$  Input 200 V/Div, Ch3: SCR Gate, Ch4: Fault Test (Pin 6)<sup>(6)</sup>**



**Figure 5. Pass Simulated Ground Fault Test; Ch Math:  $V_{AC}$  Input 200 V/Div, Ch3: SCR Gate, Ch4: Fault Test (Pin 6)**



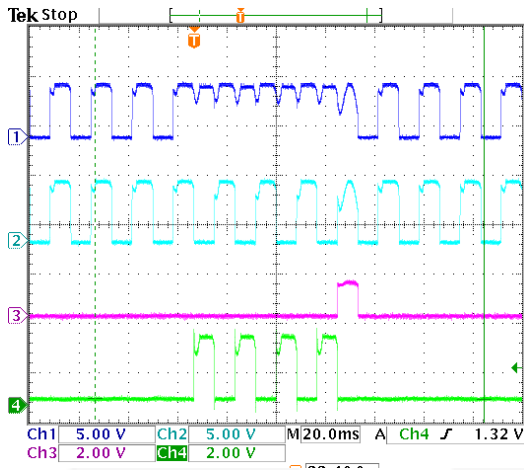
**Figure 6. Pass Simulated Ground Fault Test; Ch1: SCR Test (Pin 1), Ch2: Phase (Pin 4), Ch3: SCR Gate, Ch4: Fault Test (Pin 6)<sup>(7)</sup>**

### Notes:

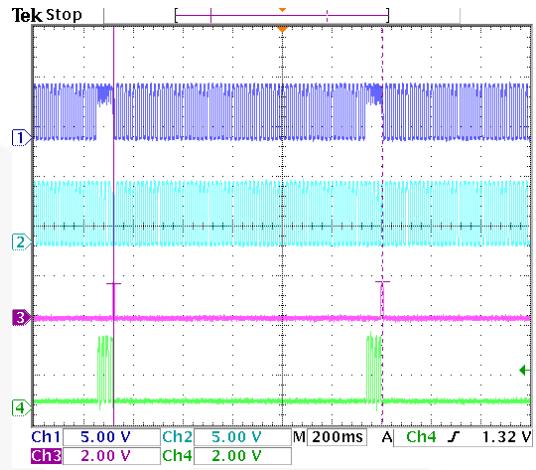
6. Anode voltage is tested during the positive half cycle (internal latch set when  $V_{AC} > 85 V_{rms}$ ).
7. During the simulated ground fault test, the SCR discharges the pre-biased SCR Test pin.

## Ground Fault Tests

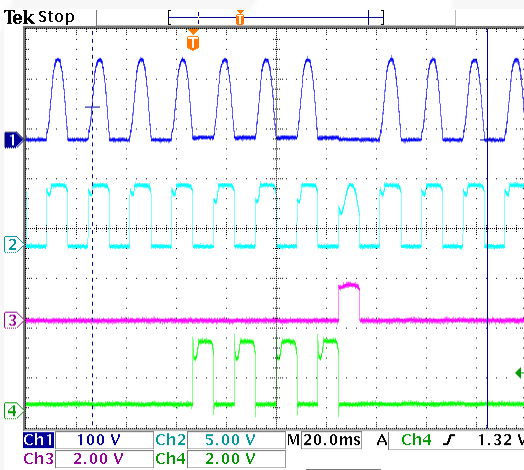
SCR, GFI, sense coil, and solenoid failures.



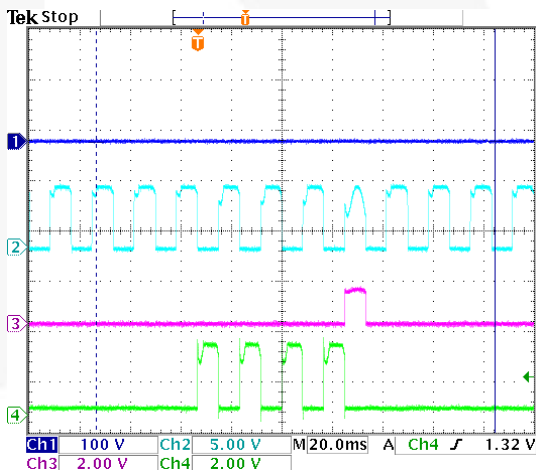
**Figure 7. SCR Test Ch1: SCR Test (Pin 1), Ch 2: Phase (Pin 4), Ch 3: EOL Alarm (Pin 5), Ch 4: Fault Test (Pin 6)<sup>(8)</sup>**



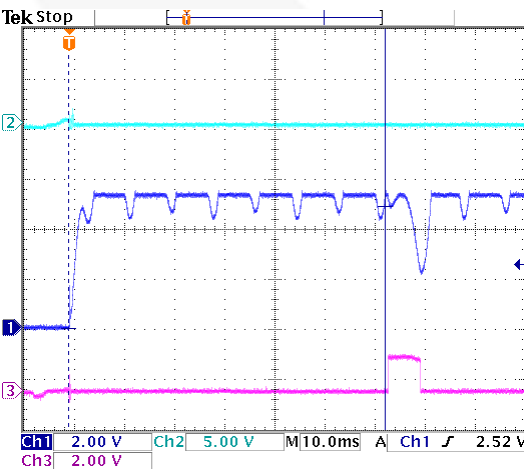
**Figure 8. SCR Test Ch1: SCR Test (Pin 1); Ch2: Phase (Pin 4); Ch3: EOL Alarm (Pin 5), Ch4: Fault Test (Pin 6)<sup>(9)</sup>**



**Figure 9. GFI / Sense Coil Tests Ch1: SCR Anode (100 V/div), Ch2: Phase (Pin 4), Ch3: EOL Alarm (Pin 5), Ch4: Fault Test (Pin 6)<sup>(10)</sup>**



**Figure 10. Solenoid Test Ch1: SCR Anode (100 V/Div), Ch2: Phase (Pin 4), Ch3: EOL Alarm (Pin 5), Ch4: Fault Test (Pin 6)<sup>(11)</sup>**

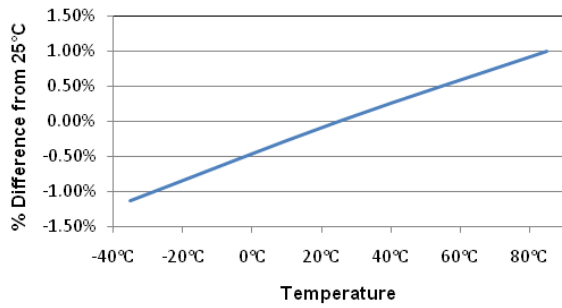


**Figure 11. Phase Pin, Continuity Test; Ch1: VDD (Pin 3), Ch2: Phase (Pin 4), Ch3: EOL Alarm (Pin 5)<sup>(12,13)</sup>**

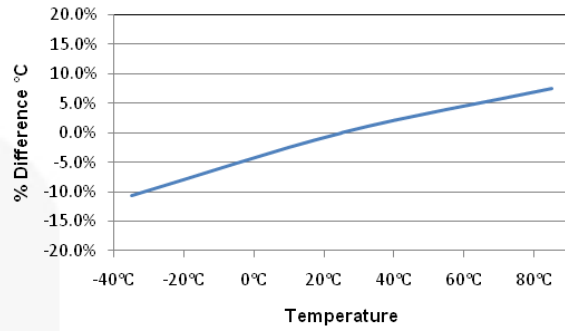
### Notes:

8. This test is with the SCR disabled. The EOL alarm signal is enabled after "time out" 66 ms timer has expired. The EOL alarm signal is connected to the gate of a SCR.
9. This test is the same as Figure 7, except for the time scale. After a self-test failure, an EOL alarm pulse is generated every one second.
10. This test is with the FAN4149 GFI controller disabled.
11. This test is with the solenoid open.
12. This test is with the Phase pin open.
13. If no signal is detected for the Phase pin within 60 ms of the POR, an EOL alarm is enabled. The SCR is enabled, which causes the  $V_{DD}$  voltage to drop and generates a POR cycle.

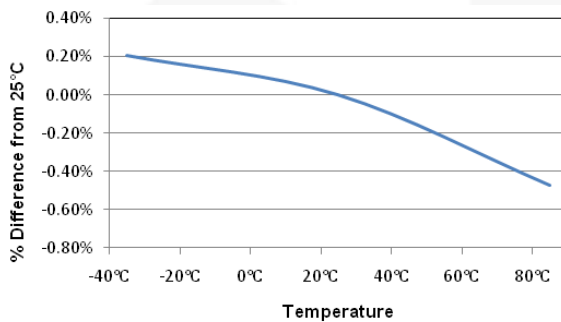
## Typical Temperature Characteristics



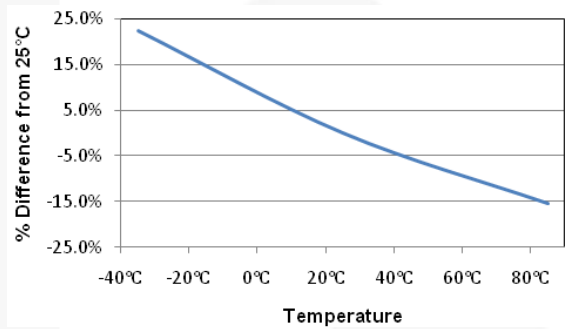
**Figure 12. Shunt Regulator Voltage vs. Temperature**



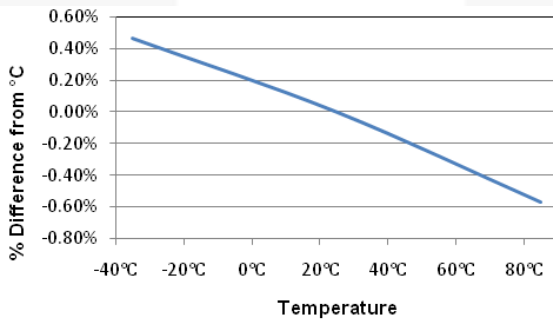
**Figure 13. Quiescent Current vs. Temperature**



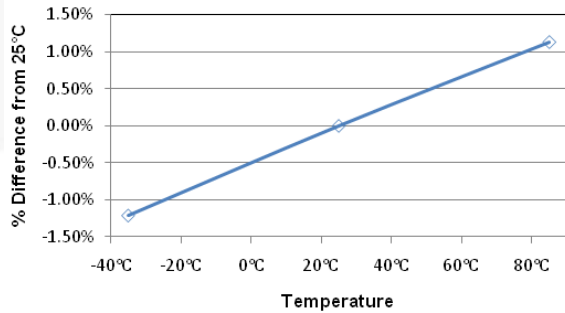
**Figure 14. Under-Voltage Reset vs. Temperature**



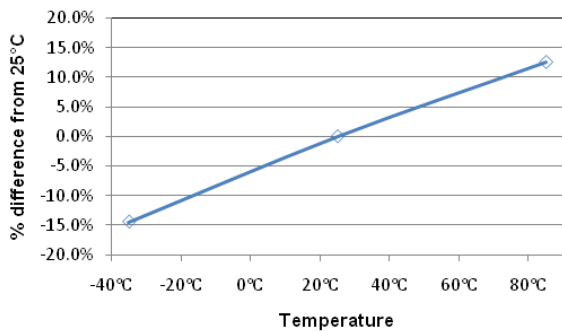
**Figure 15. Phase Pin Continuity Check Time vs. Temperature**



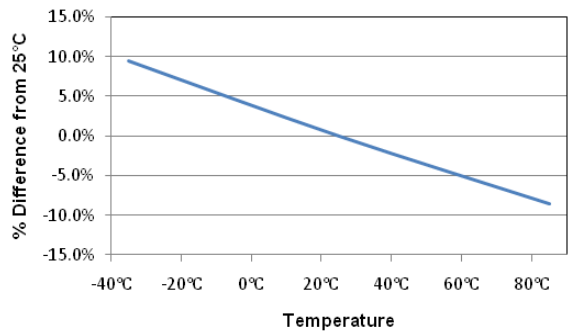
**Figure 16. Phase Pin Voltage Clamp High vs. Temperature**



**Figure 17. SCR Test Pin Voltage Clamp High vs. Temperature**

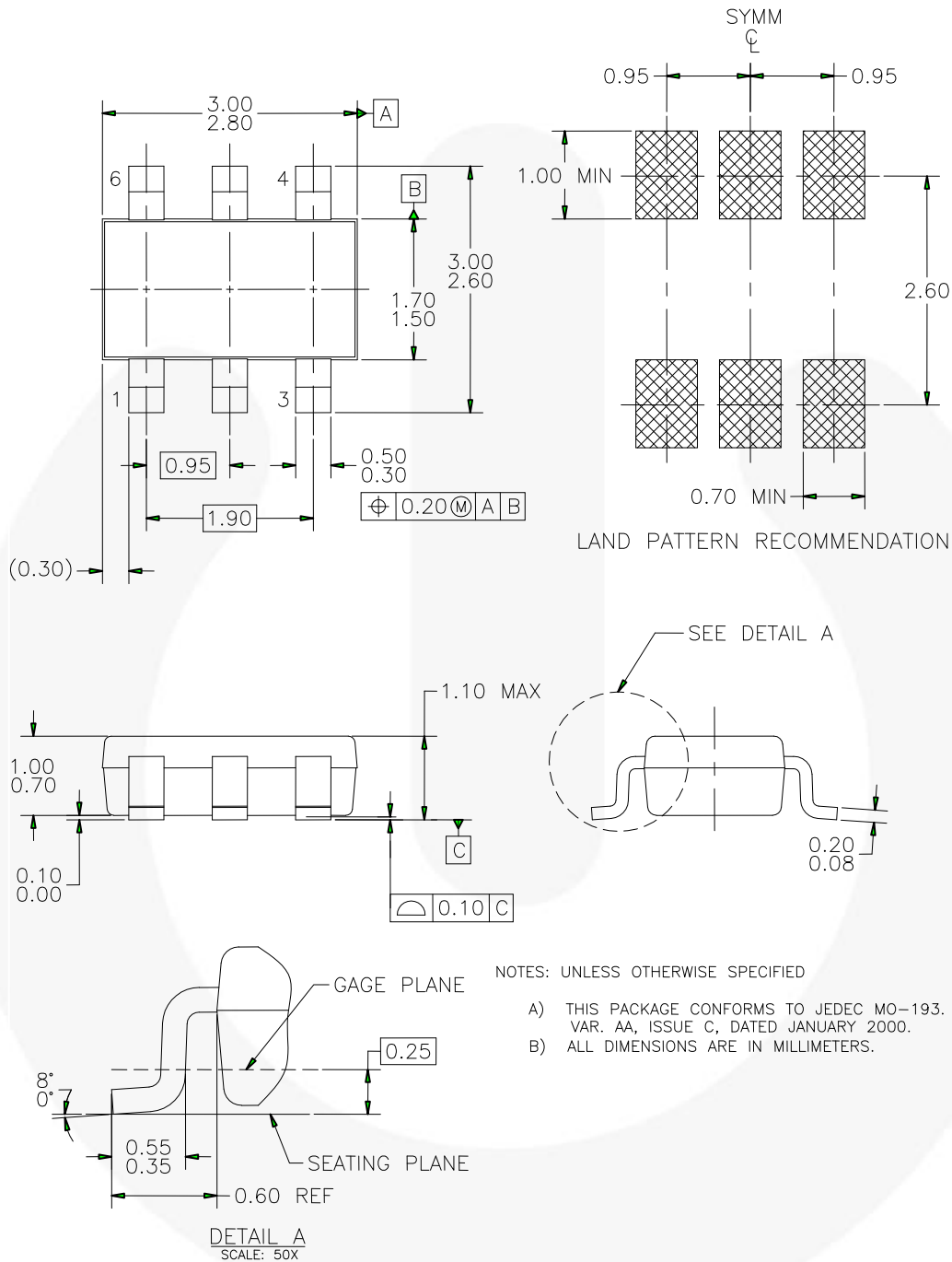


**Figure 18. Fault Test Pin Current vs. Temperature**



**Figure 19. EOL Alarm Pin  $I_{OUT}$  vs. Temperature**

## Physical Dimensions



**Figure 20. 6-Lead, SuperSOT™-6, JEDEC M0-193, 1.6 mm**

Package drawings are provided as a service to customers considering Fairchild components. Drawings may change in any manner without notice. Please note the revision and/or date on the drawing and contact a Fairchild Semiconductor representative to verify or obtain the most recent revision. Package specifications do not expand the terms of Fairchild's worldwide terms and conditions, specifically the warranty therein, which covers Fairchild products.

Always visit Fairchild Semiconductor's online packaging area for the most recent package drawings:  
<http://www.fairchildsemi.com/dwg/MA/MA06A.pdf>

For current packing container specifications, visit Fairchild Semiconductor's online packaging area:  
[http://www.fairchildsemi.com/packing\\_dwg/PKG-MA06A.pdf](http://www.fairchildsemi.com/packing_dwg/PKG-MA06A.pdf)



**TRADEMARKS**

The following includes registered and unregistered trademarks and service marks, owned by Fairchild Semiconductor and/or its global subsidiaries, and is not intended to be an exhaustive list of all such trademarks.

- |                          |  |                                       |                  |
|--------------------------|--|---------------------------------------|------------------|
| AccuPower™               | F-PFS™   |                                       |                  |
| AX-CAP®*                 | FRFET®   | PowerTrench®                          | TinyBoost®       |
| BitSiC™                  | Global Power Resource™                         | PowerXS™                              | TinyBuck®        |
| Build it Now™            | GreenBridge™                                   | Programmable Active Droop™            | TinyCalc™        |
| CorePLUS™                | Green FPS™                                     | QFET®                                 | TinyLogic®       |
| CorePOWER™               | Green FPS™ e-Series™                           | QS™                                   | TINYOPTO™        |
| CROSSVOLT™               | Gmax™  | Quiet Series™                         | TinyPower™       |
| CTL™                     | GTO™   | RapidConfigure™                       | TinyPWM™         |
| Current Transfer Logic™  | IntelliMAX™                                    |                                       | TinyWire™        |
| DEUXPEED®                | ISOPANAR™                                      | Saving our world, 1mW/W/kW at a time™ | TranSiC™         |
| Dual Cool™               | Making Small Speakers Sound Louder and Better™ | SignalWise™                           | TriFault Detect™ |
| EcoSPARK®                | MegaBuck™                                      | SmartMax™                             | TRUECURRENT®*    |
| EfficientMax™            | MICROCOUPLER™                                  | SMART START™                          | µSerDes™         |
| ESBC™                    | MicroFET™                                      | Solutions for Your Success™           |                  |
|                          | MicroPak™                                      | SPM®                                  | UHC®             |
| Fairchild®               | MicroPak2™                                     | STEALTH™                              | Ultra FRFET™     |
| Fairchild Semiconductor® | MillerDrive™                                   | SuperFET®                             | UniFET™          |
| FACT Quiet Series™       | MotionMax™                                     | SuperSOT™-3                           | VCX™             |
| FACT®                    | mWSaver®                                       | SuperSOT™-6                           | VisuaIMax™       |
| FAST®                    | OptoHiT™                                       | SuperSOT™-8                           | VoltagePlus™     |
| FastvCore™               | OPTOLOGIC®                                     | SupreMOS®                             | XS™              |
| FETBench™                | OPTOPLANAR®                                    | SyncFET™                              | 仙童™              |
| FPS™                     |  | Sync-Lock™                            |                  |

\* Trademarks of System General Corporation, used under license by Fairchild Semiconductor.

**DISCLAIMER**

FAIRCHILD SEMICONDUCTOR RESERVES THE RIGHT TO MAKE CHANGES WITHOUT FURTHER NOTICE TO ANY PRODUCTS HEREIN TO IMPROVE RELIABILITY, FUNCTION, OR DESIGN. FAIRCHILD DOES NOT ASSUME ANY LIABILITY ARISING OUT OF THE APPLICATION OR USE OF ANY PRODUCT OR CIRCUIT DESCRIBED HEREIN; NEITHER DOES IT CONVEY ANY LICENSE UNDER ITS PATENT RIGHTS, NOR THE RIGHTS OF OTHERS. THESE SPECIFICATIONS DO NOT EXPAND THE TERMS OF FAIRCHILD'S WORLDWIDE TERMS AND CONDITIONS, SPECIFICALLY THE WARRANTY THEREIN, WHICH COVERS THESE PRODUCTS.

**LIFE SUPPORT POLICY**

FAIRCHILD'S PRODUCTS ARE NOT AUTHORIZED FOR USE AS CRITICAL COMPONENTS IN LIFE SUPPORT DEVICES OR SYSTEMS WITHOUT THE EXPRESS WRITTEN APPROVAL OF FAIRCHILD SEMICONDUCTOR CORPORATION.

As used herein:

1. Life support devices or systems are devices or systems which, (a) are intended for surgical implant into the body or (b) support or sustain life, and (c) whose failure to perform when properly used in accordance with instructions for use provided in the labeling, can be reasonably expected to result in a significant injury of the user.
2. A critical component in any component of a life support, device, or system whose failure to perform can be reasonably expected to cause the failure of the life support device or system, or to affect its safety or effectiveness.

**ANTI-COUNTERFEITING POLICY**

Fairchild Semiconductor Corporation's Anti-Counterfeiting Policy. Fairchild's Anti-Counterfeiting Policy is also stated on our external website, [www.fairchildsemi.com](http://www.fairchildsemi.com), under Sales Support.

Counterfeiting of semiconductor parts is a growing problem in the industry. All manufacturers of semiconductor products are experiencing counterfeiting of their parts. Customers who inadvertently purchase counterfeit parts experience many problems such as loss of brand reputation, substandard performance, failed applications, and increased cost of production and manufacturing delays. Fairchild is taking strong measures to protect ourselves and our customers from the proliferation of counterfeit parts. Fairchild strongly encourages customers to purchase Fairchild parts either directly from Fairchild or from Authorized Fairchild Distributors who are listed by country on our web page cited above. Products customers buy either from Fairchild directly or from Authorized Fairchild Distributors are genuine parts, have full traceability, meet Fairchild's quality standards for handling and storage and provide access to Fairchild's full range of up-to-date technical and product information. Fairchild and our Authorized Distributors will stand behind all warranties and will appropriately address any warranty issues that may arise. Fairchild will not provide any warranty coverage or other assistance for parts bought from Unauthorized Sources. Fairchild is committed to combat this global problem and encourage our customers to do their part in stopping this practice by buying direct or from authorized distributors.

**PRODUCT STATUS DEFINITIONS**

**Definition of Terms**

Datasheet Identification	Product Status	Definition
Advance Information	Formative / In Design	Datasheet contains the design specifications for product development. Specifications may change in any manner without notice.
Preliminary	First Production	Datasheet contains preliminary data; supplementary data will be published at a later date. Fairchild Semiconductor reserves the right to make changes at any time without notice to improve design.
No Identification Needed	Full Production	Datasheet contains final specifications. Fairchild Semiconductor reserves the right to make changes at any time without notice to improve the design.
Obsolete	Not In Production	Datasheet contains specifications on a product that is discontinued by Fairchild Semiconductor. The datasheet is for reference information only.

Rev. 168

ON Semiconductor and  are trademarks of Semiconductor Components Industries, LLC dba ON Semiconductor or its subsidiaries in the United States and/or other countries. ON Semiconductor owns the rights to a number of patents, trademarks, copyrights, trade secrets, and other intellectual property. A listing of ON Semiconductor's product/patent coverage may be accessed at [www.onsemi.com/site/pdf/Patent-Marking.pdf](http://www.onsemi.com/site/pdf/Patent-Marking.pdf). ON Semiconductor reserves the right to make changes without further notice to any products herein. ON Semiconductor makes no warranty, representation or guarantee regarding the suitability of its products for any particular purpose, nor does ON Semiconductor assume any liability arising out of the application or use of any product or circuit, and specifically disclaims any and all liability, including without limitation special, consequential or incidental damages. Buyer is responsible for its products and applications using ON Semiconductor products, including compliance with all laws, regulations and safety requirements or standards, regardless of any support or applications information provided by ON Semiconductor. "Typical" parameters which may be provided in ON Semiconductor data sheets and/or specifications can and do vary in different applications and actual performance may vary over time. All operating parameters, including "Typicals" must be validated for each customer application by customer's technical experts. ON Semiconductor does not convey any license under its patent rights nor the rights of others. ON Semiconductor products are not designed, intended, or authorized for use as a critical component in life support systems or any FDA Class 3 medical devices or medical devices with a same or similar classification in a foreign jurisdiction or any devices intended for implantation in the human body. Should Buyer purchase or use ON Semiconductor products for any such unintended or unauthorized application, Buyer shall indemnify and hold ON Semiconductor and its officers, employees, subsidiaries, affiliates, and distributors harmless against all claims, costs, damages, and expenses, and reasonable attorney fees arising out of, directly or indirectly, any claim of personal injury or death associated with such unintended or unauthorized use, even if such claim alleges that ON Semiconductor was negligent regarding the design or manufacture of the part. ON Semiconductor is an Equal Opportunity/Affirmative Action Employer. This literature is subject to all applicable copyright laws and is not for resale in any manner.

## PUBLICATION ORDERING INFORMATION

### LITERATURE FULFILLMENT:

Literature Distribution Center for ON Semiconductor  
19521 E. 32nd Pkwy, Aurora, Colorado 80011 USA  
**Phone:** 303-675-2175 or 800-344-3860 Toll Free USA/Canada  
**Fax:** 303-675-2176 or 800-344-3867 Toll Free USA/Canada  
**Email:** [orderlit@onsemi.com](mailto:orderlit@onsemi.com)

**N. American Technical Support:** 800-282-9855 Toll Free  
USA/Canada  
**Europe, Middle East and Africa Technical Support:**  
Phone: 421 33 790 2910  
**Japan Customer Focus Center**  
Phone: 81-3-5817-1050

**ON Semiconductor Website:** [www.onsemi.com](http://www.onsemi.com)  
**Order Literature:** <http://www.onsemi.com/orderlit>  
For additional information, please contact your local  
Sales Representative