



Chipsmall Limited consists of a professional team with an average of over 10 year of expertise in the distribution of electronic components. Based in Hongkong, we have already established firm and mutual-benefit business relationships with customers from,Europe,America and south Asia,supplying obsolete and hard-to-find components to meet their specific needs.

With the principle of “Quality Parts,Customers Priority,Honest Operation,and Considerate Service”,our business mainly focus on the distribution of electronic components. Line cards we deal with include Microchip,ALPS,ROHM,Xilinx,Pulse,ON,Everlight and Freescale. Main products comprise IC,Modules,Potentiometer,IC Socket,Relay,Connector.Our parts cover such applications as commercial,industrial, and automotives areas.

We are looking forward to setting up business relationship with you and hope to provide you with the best service and solution. Let us make a better world for our industry!



## Contact us

Tel: +86-755-8981 8866 Fax: +86-755-8427 6832

Email & Skype: info@chipsmall.com Web: www.chipsmall.com

Address: A1208, Overseas Decoration Building, #122 Zhenhua RD., Futian, Shenzhen, China





Is Now Part of



**ON Semiconductor®**

To learn more about ON Semiconductor, please visit our website at  
[www.onsemi.com](http://www.onsemi.com)

ON Semiconductor and the ON Semiconductor logo are trademarks of Semiconductor Components Industries, LLC dba ON Semiconductor or its subsidiaries in the United States and/or other countries. ON Semiconductor owns the rights to a number of patents, trademarks, copyrights, trade secrets, and other intellectual property. A listing of ON Semiconductor's product/patent coverage may be accessed at [www.onsemi.com/site/pdf/Patent-Marking.pdf](http://www.onsemi.com/site/pdf/Patent-Marking.pdf). ON Semiconductor reserves the right to make changes without further notice to any products herein. ON Semiconductor makes no warranty, representation or guarantee regarding the suitability of its products for any particular purpose, nor does ON Semiconductor assume any liability arising out of the application or use of any product or circuit, and specifically disclaims any and all liability, including without limitation special, consequential or incidental damages. Buyer is responsible for its products and applications using ON Semiconductor products, including compliance with all laws, regulations and safety requirements or standards, regardless of any support or applications information provided by ON Semiconductor. "Typical" parameters which may be provided in ON Semiconductor data sheets and/or specifications can and do vary in different applications and actual performance may vary over time. All operating parameters, including "Typicals" must be validated for each customer application by customer's technical experts. ON Semiconductor does not convey any license under its patent rights nor the rights of others. ON Semiconductor products are not designed, intended, or authorized for use as a critical component in life support systems or any FDA Class 3 medical devices or medical devices with a same or similar classification in a foreign jurisdiction or any devices intended for implantation in the human body. Should Buyer purchase or use ON Semiconductor products for any such unintended or unauthorized application, Buyer shall indemnify and hold ON Semiconductor and its officers, employees, subsidiaries, affiliates, and distributors harmless against all claims, costs, damages, and expenses, and reasonable attorney fees arising out of, directly or indirectly, any claim of personal injury or death associated with such unintended or unauthorized use, even if such claim alleges that ON Semiconductor was negligent regarding the design or manufacture of the part. ON Semiconductor is an Equal Opportunity/Affirmative Action Employer. This literature is subject to all applicable copyright laws and is not for resale in any manner.

# FAN5343

## 6-LED Series Boost LED Driver with Integrated Schottky Diode and Single-Wire Digital Interface

### Features

- Asynchronous Boost Converter
  - $V_{OUT}$  up to 24V
- Internal Schottky Diode
- Up to 500mW Output Power
- 2.7V to 5.5V Input Voltage Range
- Single-Wire Digital Control Interface to Set LED Brightness Levels
  - 32 Linear Steps
- Fixed Switching Frequency: 1.2MHz
- Soft-Start Capability
- Input Under-Voltage Lockout (UVLO)
- Output Over-Voltage Protection (OVP)
- Short-Circuit Detection
- Thermal Shutdown Protection (TSD)
- Small 6-Lead 2.0 x 2.0 x 0.55mm UMLP Package

### Applications

- Cellular Mobile Handsets
- Mobile Internet Devices
- Portable Media Players
- PDA, DSC, MP3 Players

### Description

The FAN5343 is an asynchronous constant-current LED driver capable of efficiently delivering up to 500mW to a string of six (6) LEDs in series. Optimized for small form factor applications, the 1.2MHz fixed switching frequency allows the use of small chip inductors and capacitors.

The FAN5343 uses a single-wire digital control interface to program the brightness levels of the LEDs in 32 linear steps by applying digital pulses.

For safety, the device features integrated over-voltage, over-current, short circuit detection, and thermal shutdown protection. In addition, input under-voltage lockout protection is triggered if the battery voltage is too low.

The FAN5343 is available in a very low profile, small form factor 2mm x 2mm x 0.55mm 6-lead UMLP package that is green and RoHS compliant.

### Ordering Information

Part Number	Temperature Range	Package	Packing
FAN5343UMPX	-40 to 85 °C	6-Lead, Ultra-Thin Molded Leadless (UMLP) Package	Tape and Reel

Typical Application Diagram

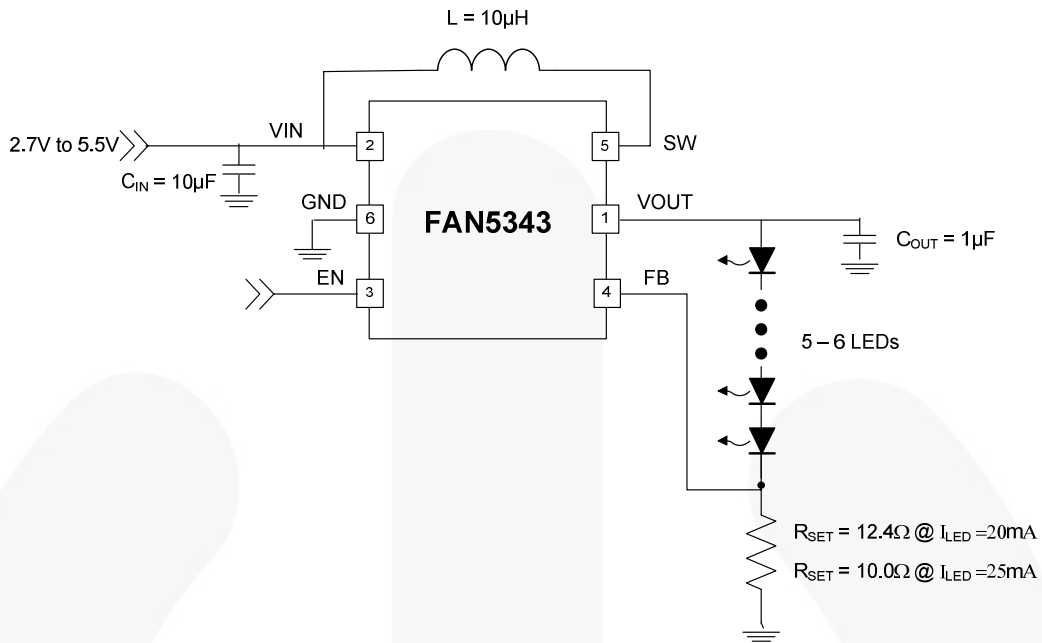

Figure 1. Typical Application

Block Diagram

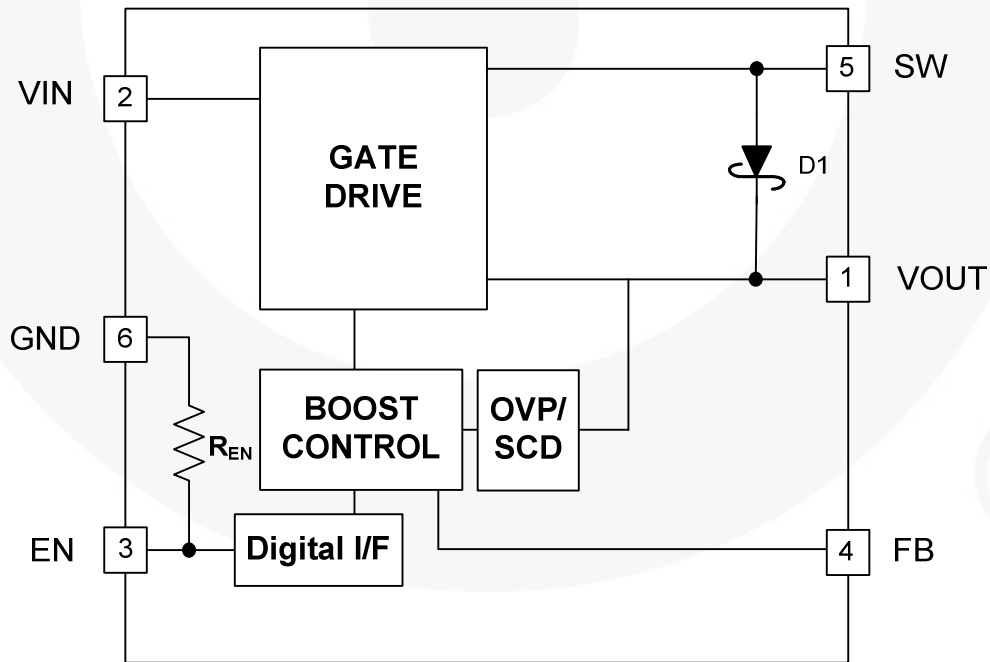

Figure 2. Block Diagram

## Pin Configuration

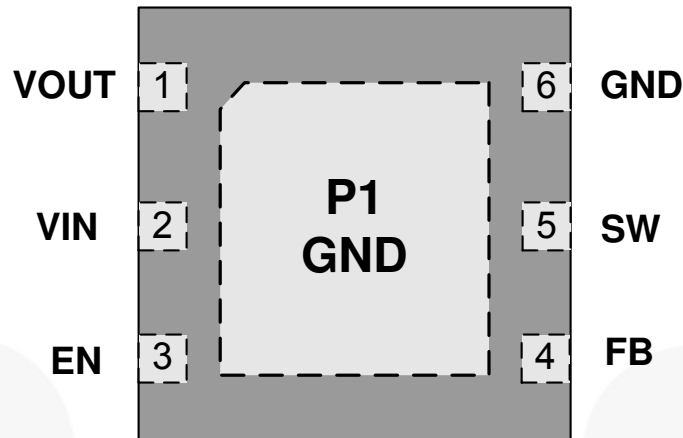

Figure 3. UMLP6 Package (Top View)

## Pin Definitions

Pin #	Name	Description
1	VOUT	<b>Boost Output Voltage.</b> Output of the boost regulator. Connect the LEDs to this pin. Connect $C_{OUT}$ to GND.
2	VIN	<b>Input Voltage.</b> Connect to power source and decouple with $C_{IN}$ to GND.
3	EN	<b>Enable Brightness Control.</b> Program dimming levels by driving this pin with digital pulses.
4	FB	<b>Voltage Feedback.</b> The boost regulator regulates this pin to 0.25V to control the LED string current. Tie this pin to a current setting resistor ( $R_{SET}$ ) between GND and the cathode of the LED string.
5	SW	<b>Switching Node.</b> Tie inductor L1 from the VIN to SW pin.
6	GND	<b>Ground.</b> Tie directly to a GND plane.



## Absolute Maximum Ratings

Stresses exceeding the absolute maximum ratings may damage the device. The device may not function or be operable above the recommended operating conditions and stressing the parts to these levels is not recommended. In addition, extended exposure to stresses above the recommended operating conditions may affect device reliability. The absolute maximum ratings are stress ratings only.

Symbol	Parameter	Min.	Max.	Units
$V_{IN}$	Voltage on VIN Pin	-0.3	6.0	V
$V_{FB}, V_{EN}$	Voltage on FB and EN Pins	-0.3	$V_{IN} + 0.3$	V
$V_{SW}$	Voltage on SW Pin	-0.3	25	V
$V_{OUT}$	Voltage on VOUT Pin	-0.3	25	V
ESD	Electrostatic Discharge Protection Level	Human Body Model per JESD22-A114	3.3	kV
		Charged Device Model per JESD22-C101	2.0	
$T_J$	Junction Temperature	-40	+150	°C
$T_{STG}$	Storage Temperature	-65	+150	°C
$T_L$	Lead Soldering Temperature, 10 Seconds		+260	°C

## Recommended Operating Conditions

The Recommended Operating Conditions table defines the conditions for actual device operation. Recommended operating conditions are specified to ensure optimal performance to the datasheet specifications. Fairchild does not recommend exceeding them or designing to absolute maximum ratings.

Symbol	Parameter	Conditions	Min.	Max.	Units
$V_{IN}$	$V_{IN}$ Supply Voltage		2.7	5.5	V
$V_{OUT}$	$V_{OUT}$ Voltage <sup>(1)</sup>		6.2	24.0	V
$I_{OUT}$	$V_{OUT}$ Load Current	500mW Maximum Output Power	5	25	mA
$T_A$	Ambient Temperature		-40	+85	°C
$T_J$	Junction Temperature		-40	+125	°C

### Note:

- Application should guarantee that minimum and maximum duty-cycle should fall between 20-85% to meet the specified range.

## Thermal Properties

Junction-to-ambient thermal resistance is a function of application and board layout. This data is measured with four-layer 2s2p boards in accordance to JEDEC standard JESD51. Special attention must be paid not to exceed junction temperature  $T_{J(max)}$  at a given ambient temperature  $T_A$ .

Symbol	Parameter	Typical	Units
$\theta_{JA}$	Junction-to-Ambient Thermal Resistance	70	°C/W

## Electrical Specifications

$V_{IN} = 2.7V$  to  $5.5V$  and  $T_A = -40^{\circ}C$  to  $+85^{\circ}C$  unless otherwise noted. Typical values are at  $T_A = 25^{\circ}C$  and  $V_{IN} = 3.6V$ .

Symbol	Parameter	Conditions	Min.	Typ.	Max.	Units
<b>Power Supplies</b>						
$I_{SD}$	Shutdown Supply Current	EN = GND, $V_{IN} = 3.6V$		0.30	0.75	$\mu A$
$V_{UVLO}$	Under-Voltage Lockout Threshold	$V_{IN}$ Rising	2.10	2.35	2.60	V
		$V_{IN}$ Falling	1.90	2.15	2.40	V
$V_{UVHYST}$	Under-Voltage Lockout Hysteresis			250		mV
<b>EN: Enable Pin</b>						
$V_{IH}$	HIGH-Level Input Voltage		1.2			V
$V_{IL}$	LOW-Level Input Voltage				0.4	V
$R_{EN}$	EN Pull-Down Resistance		200	300	400	$k\Omega$
$t_{LO}$	EN Low Time for Dimming	$V_{IN} = 3.6V$ ; See Figure 14	0.5		300.0	$\mu s$
$t_{HI}$	Time Delay Between Steps	$V_{IN} = 3.6V$ ; See Figure 14	0.5			$\mu s$
$T_{SD}$	EN Low, Shutdown Pulse Width	$V_{IN} = 3.6V$ ; from Falling Edge of EN	1			ms
<b>Feedback and Reference</b>						
$V_{FB}$	Feedback Voltage	$I_{LED} = 20mA$ from $-40^{\circ}C$ to $+85^{\circ}C$ , $2.7V \leq V_{IN} \leq 5.5V$	237	250	263	mV
$I_{FB}$	Feedback Input Current	$V_{FB} = 250mV$		0.1	1.0	$\mu A$
<b>Power Outputs</b>						
$R_{DS(ON),Q1}$	Boost Switch On-Resistance	$V_{IN} = 3.6V, I_{SW} = 100mA$		600		$m\Omega$
		$V_{IN} = 2.7V, I_{SW} = 100mA$		650		
$I_{SW(OFF)}$	SW Node Leakage <sup>(2)</sup>	EN = 0, $V_{IN} = V_{SW} = V_{OUT} = 5.5V$ , $V_{LED} = 0$		0.1	2.0	$\mu A$
$I_{LIM-PK}$	Boost Switch Peak Current Limit	$V_{IN} = 3.6V$		750		mA
<b>Oscillator</b>						
$f_{SW}$	Boost Regulator Switching Frequency		1.0	1.2	1.4	MHz
<b>Output and Protection</b>						
$V_{OVP}$	Boost Output Over-Voltage Protection		22.5	24.5		V
	OVP Hysteresis			1.0		
$V_{TLSC}$	$V_{OUT}$ Short Circuit Detection Threshold	$V_{OUT}$ Falling		$V_{IN} - 1.4$		V
$V_{THSC}$	$V_{OUT}$ Short Circuit Detection Threshold	$V_{OUT}$ Rising		$V_{IN} - 1.2$		V
$D_{MAX}$	Maximum Boost Duty Cycle <sup>(3,4)</sup>		85			%
$D_{MIN}$	Minimum Boost Duty Cycle <sup>(3,4)</sup>				20	%
$T_{TSD}$	Thermal Shutdown			150		$^{\circ}C$
$T_{HYS}$	Thermal Shutdown Hysteresis			35		$^{\circ}C$

### Notes:

- SW leakage current includes the leakage current of two internal switches; SW to GND and SW to VOUT.
- Not tested in production, but guaranteed by design
- Application should guarantee that minimum and maximum duty cycle fall between 20-85% to meet the specified range.

## Typical Characteristics

$V_{IN} = 3.6V$ ,  $T_A = 25^\circ C$ ,  $I_{LED} = 25mA$ ,  $L = 10\mu H$ ,  $C_{OUT} = 1.0\mu F$

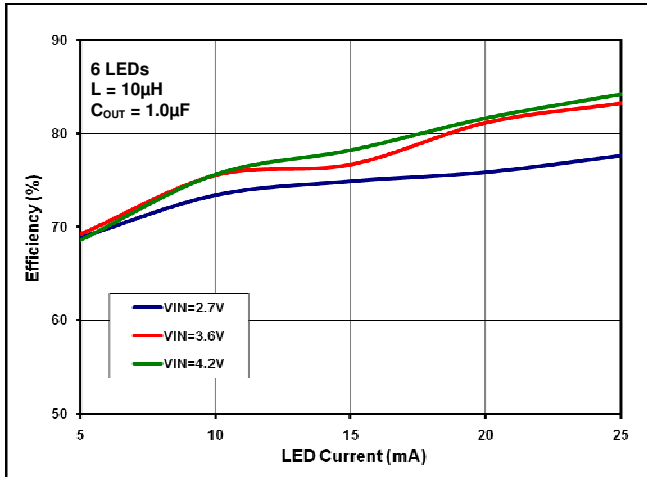

Figure 4. 6 LEDs: Efficiency vs. LED Current vs. Input Voltage

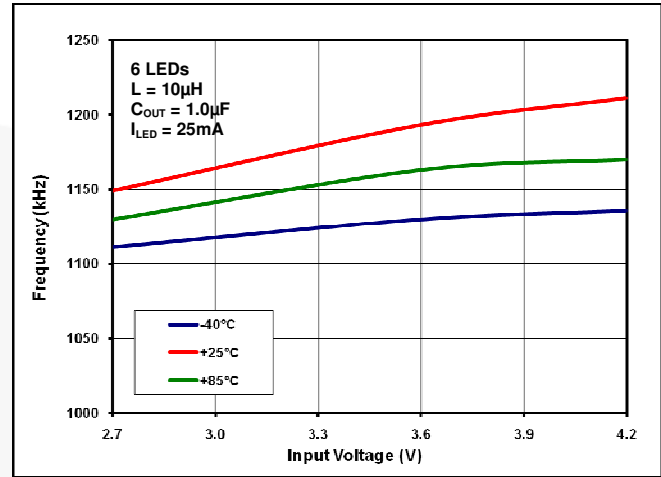

Figure 5. Frequency vs. Input Voltage vs. Temperature

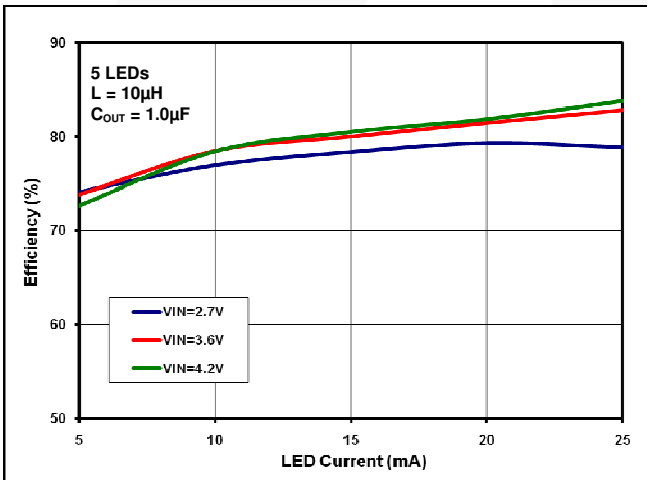

Figure 6. 5 LEDs: Efficiency vs. LED Current vs. Input Voltage

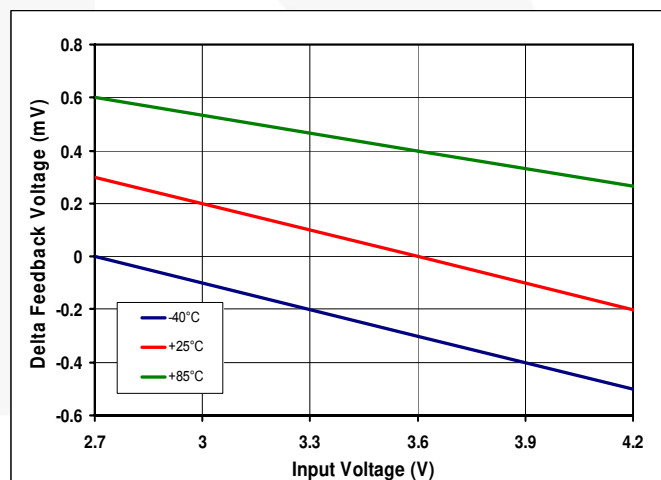

Figure 7. Delta of  $V_{FB}$  Over Input Voltage and Temperature for 6 LEDs with  $L=10\mu H$  and  $C_{OUT}=1.0\mu F$

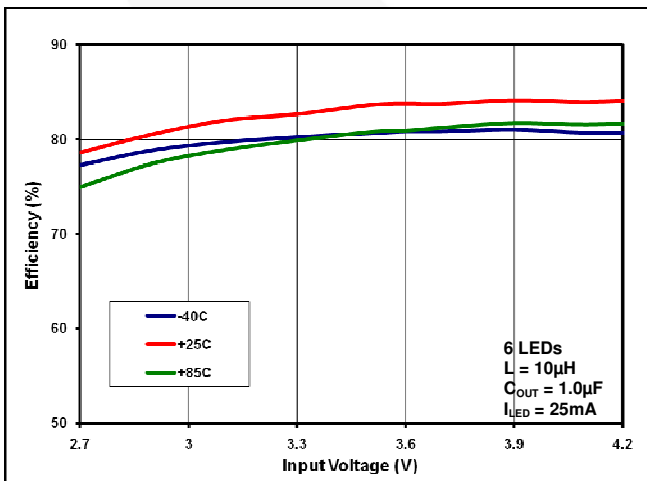

Figure 8. Efficiency vs. Input Voltage vs. Temperature

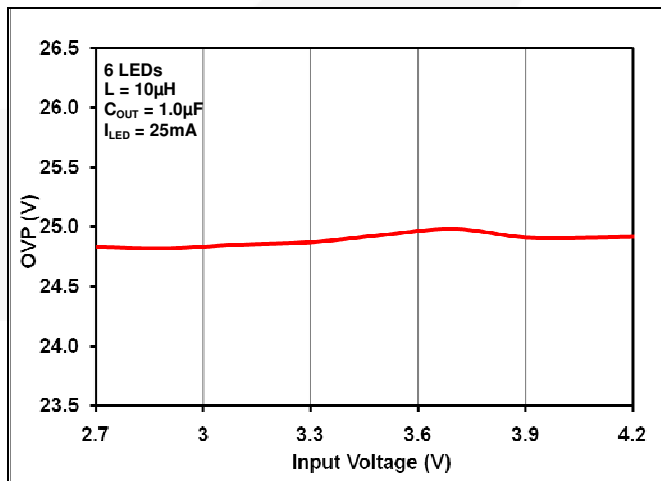

Figure 9. Over-Voltage Protection vs. Input Voltage



## Typical Characteristics

$V_{IN} = 3.6V$ ,  $T_A = 25^\circ C$ ,  $I_{LED} = 25mA$ ,  $L = 10\mu H$ ,  $C_{OUT} = 1.0\mu F$

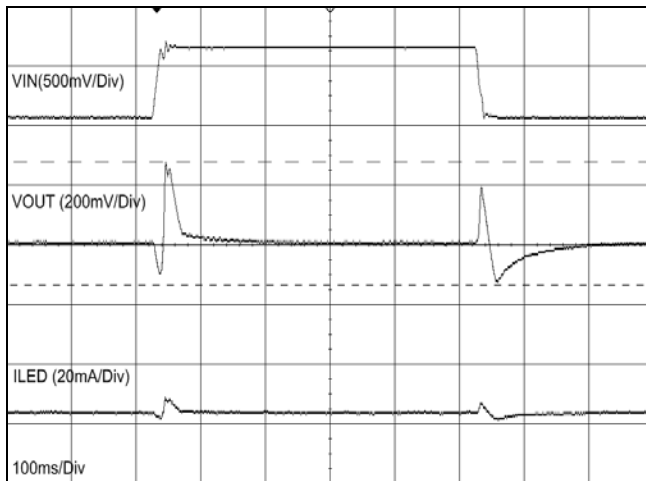

Figure 10. Line Transient Response for 6 LEDs

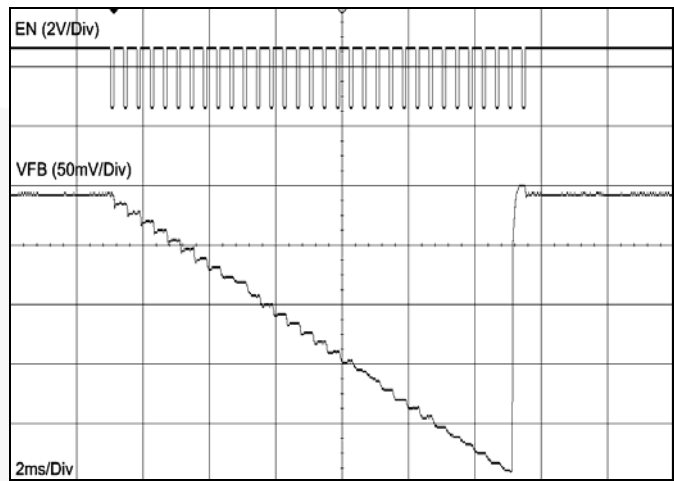

Figure 11. Dimming Operation of FAN5343

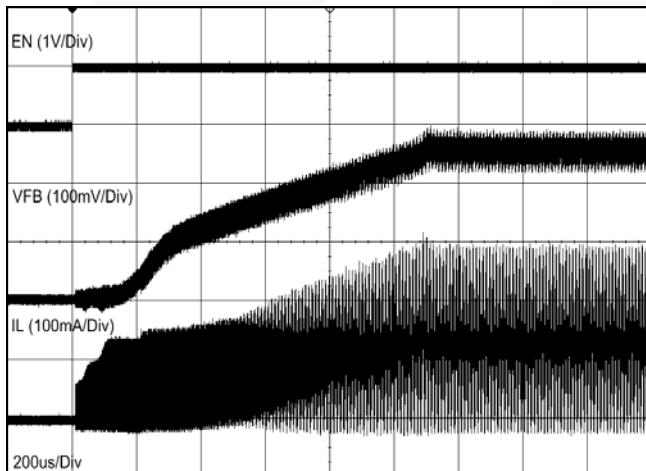

Figure 12. Startup Waveform for Switch Voltage, Inductor Current,  $V_{FB}$ , and EN for 6 LEDs

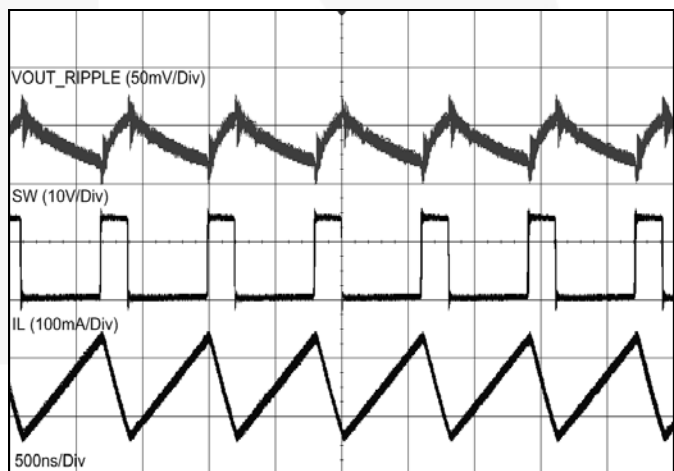

Figure 13. Steady-State Waveform for  $V_{OUT}$ , Switch Voltage, and Inductor Current for 6 LEDs

## Functional Description

### Overview

The FAN5343 is an inductive current-mode boost serial LED driver that achieves LED current regulation by maintaining 0.25V across the  $R_{SET}$  resistor. The current through the LED string ( $I_{LED}$ ) is therefore given by:

$$I_{LED} = \frac{0.25}{R_{SET}} \quad (1)$$

The voltage  $V_{OUT}$  is determined by the the sum of the forward voltages across each LED, plus the voltage across  $R_{SET}$ , which is always 250mV.

### UVLO and Soft-Start

If EN has been LOW for more than 1ms, the IC may initiate a “cold start” soft-start cycle when EN rises, provided  $V_{IN}$  is above the UVLO threshold.

### Digital Interface

The FAN5343 implements a single-wire digital interface to program the LED brightness to one of thirty two (32) levels spaced in linear steps. With this single-wire solution, the FAN5343 does not require the system processor to constantly supply a signal to drive the LEDs.

### Digital Dimming Control

The FAN5343 starts driving the LEDs at the maximum brightness level. After startup, the control logic is ready to accept programming pulses to decrease the brightness level by the positive edges applied to the EN pin. Figure 14 illustrates the digital pulse dimming control for the FAN5343.

### Over-Current and Short-Circuit Detection

The boost regulator employs a cycle-by-cycle peak inductor current limit of ~750mA to protect the switching elements and the device itself from being damaged.

### Over-Voltage / Open-Circuit Protection

If the LED string is open circuit, FB remains at 0V and the output voltage continues to increase in the absence of an Over-Voltage Protection (OVP) circuit. The FAN5343's OVP circuit disables the boost regulator when  $V_{OUT}$  exceeds 24.5V and keeps the regulator off until  $V_{OUT}$  drops below 22.5V.

### Thermal Shutdown

When the die temperature exceeds 150°C, a reset occurs and remains in effect until the die cools to 125°C; at which time, the circuit is allowed to begin the soft-start sequence.

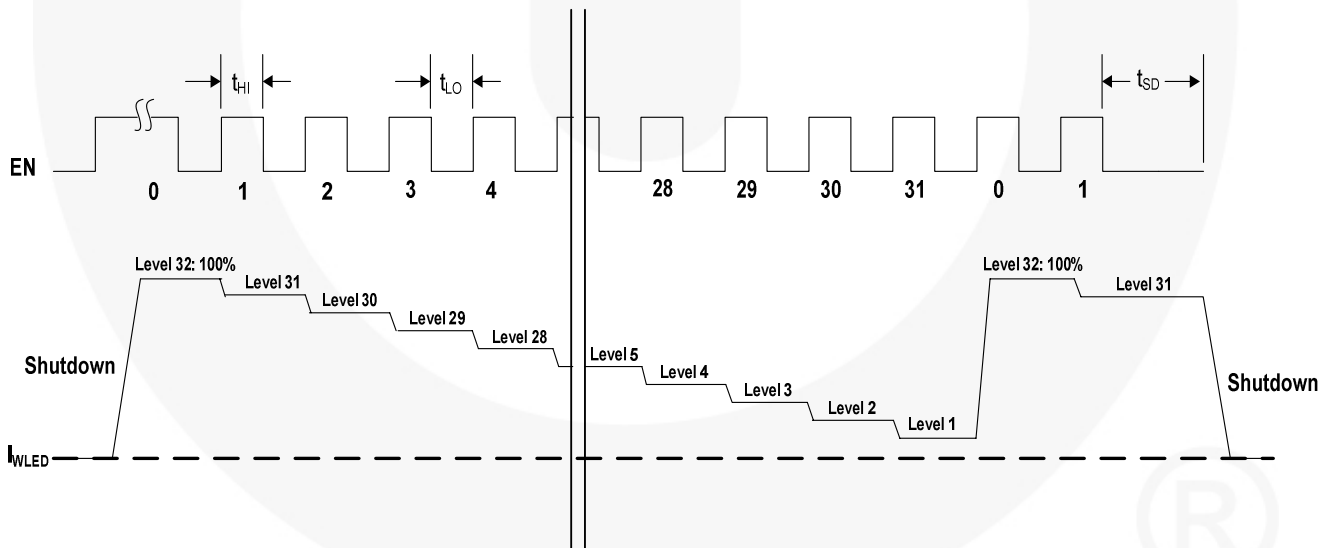

Figure 14. Digital Pulse-Dimming Control Diagram

## Application Information

### Inductor and Output Capacitor Selection

**Table 1. Recommended External Components**

# of LEDs	L	Part Number	Manufacturer	Min. C <sub>OUT</sub>	Part Number	Manufacturer
5, 6	10.0μH	LQH43MN100K03	Murata	1.00μF	UMK212BJ105KG	Taiyo Yuden
		NLCV32T-100K-PFR	TDK			
		VLF3010AT-100MR49-1	TDK			

### Component Placement and PCB Recommendations

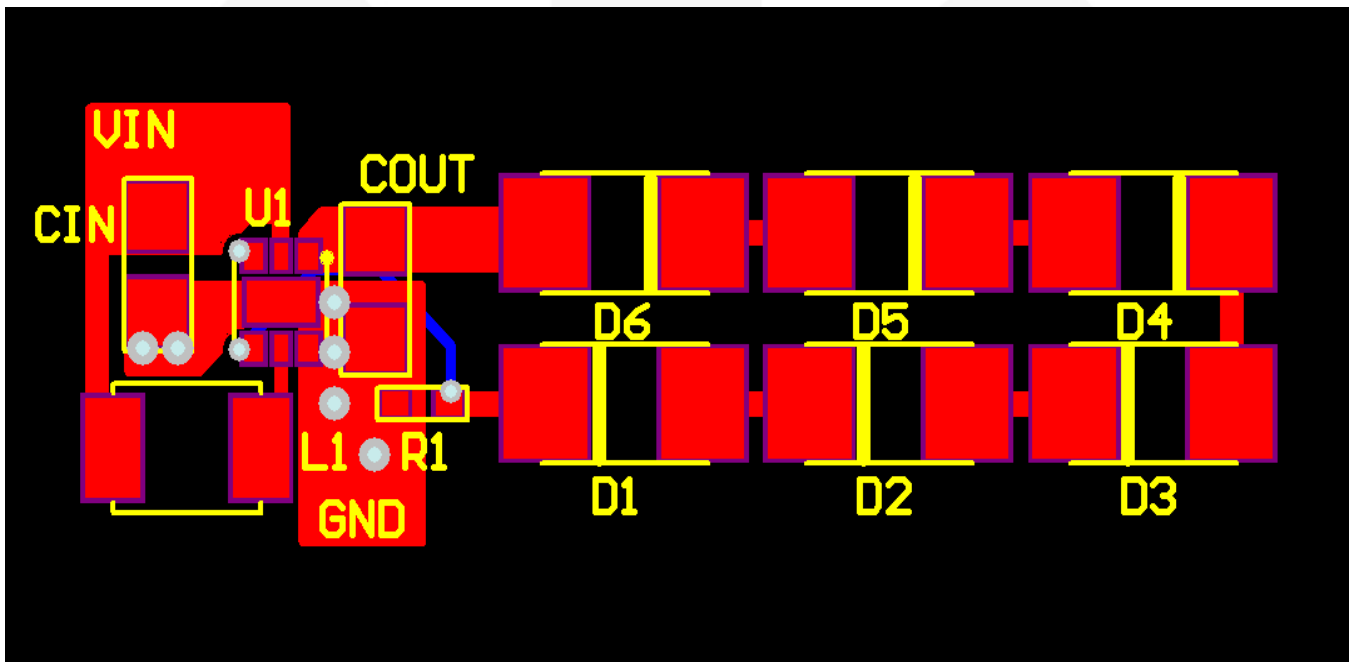

**Figure 15. Recommended Component Placement**

### Input Capacitance

In a typical application, the input and output capacitors should be placed as close to the IC as possible; no additional capacitance is needed to ensure proper functionality. However, in a testing environment, where the FAN5343 is typically powered by a power supply with relatively long cables, an additional input capacitor (10μF) may be needed to ensure stable functioning. This capacitor should be placed close to where the power supply cables attach to the FAN5343 evaluation board.

### PCB Recommendations

- The inductor can be connected to VIN with vias through another layer if needed.
- The feedback pin should be connected back to the IC on a sub-layer.

## Physical Dimensions

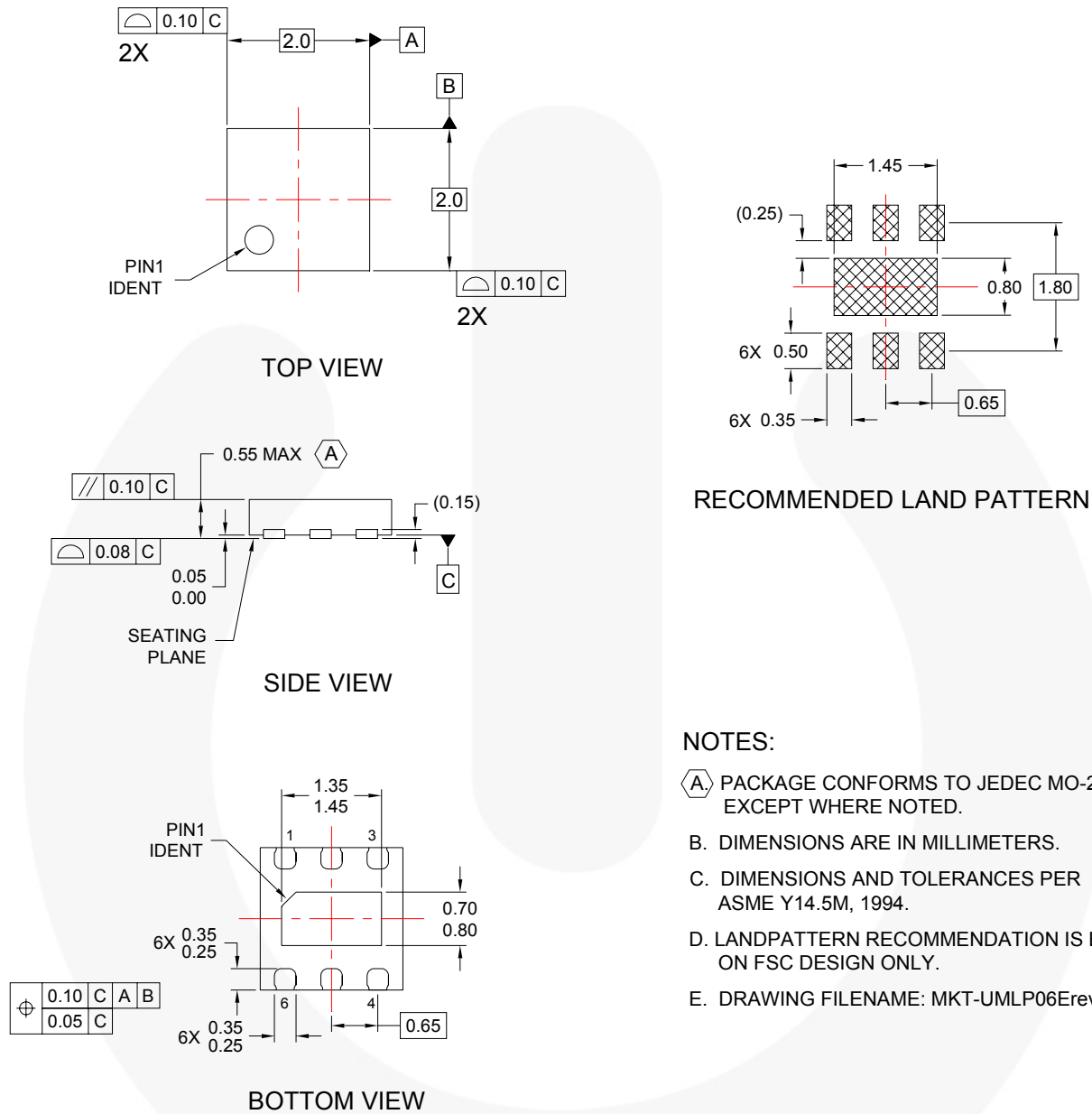

### NOTES:

- A. PACKAGE CONFORMS TO JEDEC MO-229 EXCEPT WHERE NOTED.
- B. DIMENSIONS ARE IN MILLIMETERS.
- C. DIMENSIONS AND TOLERANCES PER ASME Y14.5M, 1994.
- D. LANDPATTERN RECOMMENDATION IS BASED ON FSC DESIGN ONLY.
- E. DRAWING FILENAME: MKT-UMLP06Erev2.

**Figure 16. 6-Lead, Ultra-Thin Molded Leadless Package (UMLP)**

Package drawings are provided as a service to customers considering Fairchild components. Drawings may change in any manner without notice. Please note the revision and/or date on the drawing and contact a Fairchild Semiconductor representative to verify or obtain the most recent revision. Package specifications do not expand the terms of Fairchild's worldwide terms and conditions, specifically the warranty therein, which covers Fairchild products.

Always visit Fairchild Semiconductor's online packaging area for the most recent package drawings:  
<http://www.fairchildsemi.com/packaging/>.



**TRADEMARKS**

The following includes registered and unregistered trademarks and service marks, owned by Fairchild Semiconductor and/or its global subsidiaries, and is not intended to be an exhaustive list of all such trademarks:

- |                          |                        |                                       |   |
|--------------------------|------------------------|---------------------------------------|---|
| AccuPower™               | F-PFS™                 | Power-SPM™                            | <p>SYSTEM GENERAL®<br/>The Power Franchise®</p> <p>power franchise™</p> |
| Auto-SPM™                | FRFET®                 | PowerTrench®                          |   |
| Build it Now™            | Global Power Resource™ | PowerXS™                              |   |
| CorePLUS™                | Green FPS™             | Programmable Active Droop™            |   |
| CorePOWER™               | Green FPS™ e-Series™   | QFET®                                 |   |
| CROSSVOLT™               | Gmax™                  | QS™                                   |   |
| CTL™                     | GTO™                   | Quiet Series™                         |   |
| Current Transfer Logic™  | IntelliMAX™            | RapidConfigure™                       |   |
| DEUXPEED®                | ISOPLANAR™             | ™                                     |   |
| Dual Cool™               | MegaBuck™              | Saving our world, 1mW/W/kW at a time™ |   |
| EcoSPARK®                | MICROCOUPLER™          | SignalWise™                           |   |
| EfficientMax™            | MicroFET™              | SmartMax™                             |   |
| ESBCT™                   | MicroPak™              | SMART START™                          |   |
| ™                        | MicroPak2™             | SPM®                                  |   |
| Fairchild®               | MillerDrive™           | STEALTH™                              |   |
| Fairchild Semiconductor® | MotionMax™             | SuperFET™                             |   |
| FACT Quiet Series™       | Motion-SPM™            | SuperSOT™-3                           |   |
| FACT®                    | OptoHIT™               | SuperSOT™-8                           |   |
| FAST®                    | OPTOLOGIC®             | SuperSOT™-8                           |   |
| FastvCore™               | OPTOPLANAR®            | SupreMOS®                             |   |
| FETBench™                | ™                      | SyncFET™                              |   |
| FlashWriter®             | PDP-SPM™               | Sync-Lock™                            |   |
| FPS™                     |                        |                                       |   |

\* Trademarks of System General Corporation, used under license by Fairchild Semiconductor.

**DISCLAIMER**

FAIRCHILD SEMICONDUCTOR RESERVES THE RIGHT TO MAKE CHANGES WITHOUT FURTHER NOTICE TO ANY PRODUCTS HEREIN TO IMPROVE RELIABILITY, FUNCTION, OR DESIGN. FAIRCHILD DOES NOT ASSUME ANY LIABILITY ARISING OUT OF THE APPLICATION OR USE OF ANY PRODUCT OR CIRCUIT DESCRIBED HEREIN; NEITHER DOES IT CONVEY ANY LICENSE UNDER ITS PATENT RIGHTS, NOR THE RIGHTS OF OTHERS. THESE SPECIFICATIONS DO NOT EXPAND THE TERMS OF FAIRCHILD'S WORLDWIDE TERMS AND CONDITIONS, SPECIFICALLY THE WARRANTY THEREIN, WHICH COVERS THESE PRODUCTS.

**LIFE SUPPORT POLICY**

FAIRCHILD'S PRODUCTS ARE NOT AUTHORIZED FOR USE AS CRITICAL COMPONENTS IN LIFE SUPPORT DEVICES OR SYSTEMS WITHOUT THE EXPRESS WRITTEN APPROVAL OF FAIRCHILD SEMICONDUCTOR CORPORATION.

As used herein:

1. Life support devices or systems are devices or systems which, (a) are intended for surgical implant into the body or (b) support or sustain life, and (c) whose failure to perform when properly used in accordance with instructions for use provided in the labeling, can be reasonably expected to result in a significant injury of the user.
2. A critical component in any component of a life support device, or system whose failure to perform can be reasonably expected to cause the failure of the life support device or system, or to affect its safety or effectiveness.

**ANTI-COUNTERFEITING POLICY**

Fairchild Semiconductor Corporation's Anti-Counterfeiting Policy. Fairchild's Anti-Counterfeiting Policy is also stated on our external website, [www.fairchildsemi.com](http://www.fairchildsemi.com), under Sales Support.

Counterfeiting of semiconductor parts is a growing problem in the industry. All manufacturers of semiconductor products are experiencing counterfeiting of their parts. Customers who inadvertently purchase counterfeit parts experience many problems such as loss of brand reputation, substandard performance, failed applications, and increased cost of production and manufacturing delays. Fairchild is taking strong measures to protect ourselves and our customers from the proliferation of counterfeit parts. Fairchild strongly encourages customers to purchase Fairchild parts either directly from Fairchild or from Authorized Fairchild Distributors who are listed by country on our web page cited above. Products customers buy either from Fairchild directly or from Authorized Fairchild Distributors are genuine parts, have full traceability, meet Fairchild's quality standards for handling and storage and provide access to Fairchild's full range of up-to-date technical and product information. Fairchild and our Authorized Distributors will stand behind all warranties and will appropriately address any warranty issues that may arise. Fairchild will not provide any warranty coverage or other assistance for parts bought from Unauthorized Sources. Fairchild is committed to combat this global problem and encourage our customers to do their part in stopping this practice by buying direct or from authorized distributors.

**PRODUCT STATUS DEFINITIONS**

**Definition of Terms**

Datasheet Identification	Product Status	Definition
Advance Information	Formative / In Design	Datasheet contains the design specifications for product development. Specifications may change in any manner without notice.
Preliminary	First Production	Datasheet contains preliminary data; supplementary data will be published at a later date. Fairchild Semiconductor reserves the right to make changes at any time without notice to improve design.
No Identification Needed	Full Production	Datasheet contains final specifications. Fairchild Semiconductor reserves the right to make changes at any time without notice to improve the design.
Obsolete	Not In Production	Datasheet contains specifications on a product that is discontinued by Fairchild Semiconductor. The datasheet is for reference information only.

Rev. I49

ON Semiconductor and  are trademarks of Semiconductor Components Industries, LLC dba ON Semiconductor or its subsidiaries in the United States and/or other countries. ON Semiconductor owns the rights to a number of patents, trademarks, copyrights, trade secrets, and other intellectual property. A listing of ON Semiconductor's product/patent coverage may be accessed at [www.onsemi.com/site/pdf/Patent-Marking.pdf](http://www.onsemi.com/site/pdf/Patent-Marking.pdf). ON Semiconductor reserves the right to make changes without further notice to any products herein. ON Semiconductor makes no warranty, representation or guarantee regarding the suitability of its products for any particular purpose, nor does ON Semiconductor assume any liability arising out of the application or use of any product or circuit, and specifically disclaims any and all liability, including without limitation special, consequential or incidental damages. Buyer is responsible for its products and applications using ON Semiconductor products, including compliance with all laws, regulations and safety requirements or standards, regardless of any support or applications information provided by ON Semiconductor. "Typical" parameters which may be provided in ON Semiconductor data sheets and/or specifications can and do vary in different applications and actual performance may vary over time. All operating parameters, including "Typicals" must be validated for each customer application by customer's technical experts. ON Semiconductor does not convey any license under its patent rights nor the rights of others. ON Semiconductor products are not designed, intended, or authorized for use as a critical component in life support systems or any FDA Class 3 medical devices or medical devices with a same or similar classification in a foreign jurisdiction or any devices intended for implantation in the human body. Should Buyer purchase or use ON Semiconductor products for any such unintended or unauthorized application, Buyer shall indemnify and hold ON Semiconductor and its officers, employees, subsidiaries, affiliates, and distributors harmless against all claims, costs, damages, and expenses, and reasonable attorney fees arising out of, directly or indirectly, any claim of personal injury or death associated with such unintended or unauthorized use, even if such claim alleges that ON Semiconductor was negligent regarding the design or manufacture of the part. ON Semiconductor is an Equal Opportunity/Affirmative Action Employer. This literature is subject to all applicable copyright laws and is not for resale in any manner.

## PUBLICATION ORDERING INFORMATION

### LITERATURE FULFILLMENT:

Literature Distribution Center for ON Semiconductor  
19521 E. 32nd Pkwy, Aurora, Colorado 80011 USA  
**Phone:** 303-675-2175 or 800-344-3860 Toll Free USA/Canada  
**Fax:** 303-675-2176 or 800-344-3867 Toll Free USA/Canada  
**Email:** [orderlit@onsemi.com](mailto:orderlit@onsemi.com)

**N. American Technical Support:** 800-282-9855 Toll Free  
USA/Canada  
**Europe, Middle East and Africa Technical Support:**  
Phone: 421 33 790 2910  
**Japan Customer Focus Center**  
Phone: 81-3-5817-1050

**ON Semiconductor Website:** [www.onsemi.com](http://www.onsemi.com)  
**Order Literature:** <http://www.onsemi.com/orderlit>  
For additional information, please contact your local  
Sales Representative