



Chipsmall Limited consists of a professional team with an average of over 10 year of expertise in the distribution of electronic components. Based in Hongkong, we have already established firm and mutual-benefit business relationships with customers from,Europe,America and south Asia,supplying obsolete and hard-to-find components to meet their specific needs.

With the principle of “Quality Parts,Customers Priority,Honest Operation,and Considerate Service”,our business mainly focus on the distribution of electronic components. Line cards we deal with include Microchip,ALPS,ROHM,Xilinx,Pulse,ON,Everlight and Freescale. Main products comprise IC,Modules,Potentiometer,IC Socket,Relay,Connector.Our parts cover such applications as commercial,industrial, and automotives areas.

We are looking forward to setting up business relationship with you and hope to provide you with the best service and solution. Let us make a better world for our industry!



Contact us

Tel: +86-755-8981 8866 Fax: +86-755-8427 6832

Email & Skype: info@chipsmall.com Web: www.chipsmall.com

Address: A1208, Overseas Decoration Building, #122 Zhenhua RD., Futian, Shenzhen, China





Is Now Part of



ON Semiconductor®

To learn more about ON Semiconductor, please visit our website at

www.onsemi.com

ON Semiconductor and the ON Semiconductor logo are trademarks of Semiconductor Components Industries, LLC dba ON Semiconductor or its subsidiaries in the United States and/or other countries. ON Semiconductor owns the rights to a number of patents, trademarks, copyrights, trade secrets, and other intellectual property. A listing of ON Semiconductor's product/patent coverage may be accessed at www.onsemi.com/site/pdf/Patent-Marking.pdf. ON Semiconductor reserves the right to make changes without further notice to any products herein. ON Semiconductor makes no warranty, representation or guarantee regarding the suitability of its products for any particular purpose, nor does ON Semiconductor assume any liability arising out of the application or use of any product or circuit, and specifically disclaims any and all liability, including without limitation special, consequential or incidental damages. Buyer is responsible for its products and applications using ON Semiconductor products, including compliance with all laws, regulations and safety requirements or standards, regardless of any support or applications information provided by ON Semiconductor. "Typical" parameters which may be provided in ON Semiconductor data sheets and/or specifications can and do vary in different applications and actual performance may vary over time. All operating parameters, including "Typicals" must be validated for each customer application by customer's technical experts. ON Semiconductor does not convey any license under its patent rights nor the rights of others. ON Semiconductor products are not designed, intended, or authorized for use as a critical component in life support systems or any FDA Class 3 medical devices or medical devices with a same or similar classification in a foreign jurisdiction or any devices intended for implantation in the human body. Should Buyer purchase or use ON Semiconductor products for any such unintended or unauthorized application, Buyer shall indemnify and hold ON Semiconductor and its officers, employees, subsidiaries, affiliates, and distributors harmless against all claims, costs, damages, and expenses, and reasonable attorney fees arising out of, directly or indirectly, any claim of personal injury or death associated with such unintended or unauthorized use, even if such claim alleges that ON Semiconductor was negligent regarding the design or manufacture of the part. ON Semiconductor is an Equal Opportunity/Affirmative Action Employer. This literature is subject to all applicable copyright laws and is not for resale in any manner.

FAN5602 — Universal (Step-Up/Step-Down) Charge Pump Regulated DC/DC Converter

Features

- Low-Noise, Constant-Frequency Operation at Heavy Load
- High-Efficiency, Pulse-Skip (PFM) Operation at Light Load
- Switch Configurations (1:3, 1:2, 2:3, 1:1, 3:2, 2:1, 3:1)
- 92% Peak Efficiency
- Input Voltage Range: 2.7V to 5.5V
- Output Current: 4.5V, 100mA at $V_{IN} = 3.6V$
- $\pm 3\%$ Output Voltage Accuracy
- $I_{CC} < 1\mu A$ in Shutdown Mode
- 1MHz Operating Frequency
- Shutdown Isolates Output from Input
- Soft-Start Limits Inrush Current at Startup
- Short-Circuit and Over-Temperature Protection
- Minimum External Component Count
- No Inductors

Applications

- Cell Phones
- Handheld Computers
- Portable RF Communication Equipment
- Core Supply to Low-Power Processors
- Low-Voltage DC Bus
- DSP Supplies

Description

The FAN5602 is a universal switched capacitor DC/DC converter capable of step-up or step-down operation. Due to its unique adaptive fractional switching topology, the device achieves high efficiency over a wider input/output voltage range than any of its predecessors. The FAN5602 utilizes resistance-modulated loop control, which produces lower switching noise than other topologies. Depending upon actual load conditions, the device automatically switches between constant-frequency and pulse-skipping modes of operation to extend battery life.

The FAN5602 produces a fixed regulated output within the range of 2.7V to 5.5V from any type of voltage source. High efficiency is achieved under various input/output voltage conditions because an internal logic circuit automatically reconfigures the system to the best possible topology. Only two $1\mu F$ bucket capacitors and one $10\mu F$ output capacitor are needed. During power on, soft-start circuitry prevents excessive current drawn from the supply. The device is protected against short-circuit and over-temperature conditions.

The FAN5602 is available with 4.5V and 5.0V output voltages in a 3x3mm 8-lead MLP package.

Ordering Information

Part Number	Package	 Eco Status	Output Voltage, N_{VOM}
FAM6502MP45X	3x3mm 8-Lead MLP	Green	4.5V
FAN5602MP5X	3x3mm 8-Lead MLP	Green	5.0V

Note:

1. Reference MLP08D Option B ONLY.
2.  For Fairchild's definition of "green" Eco Status, please visit: http://www.fairchildsemi.com/company/green/rohs_green.html.

Application Diagram

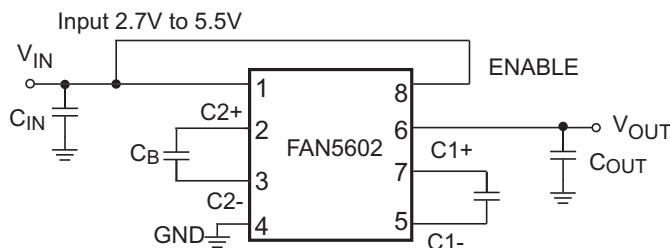

Figure 1. Typical Application Diagram

Block Diagram

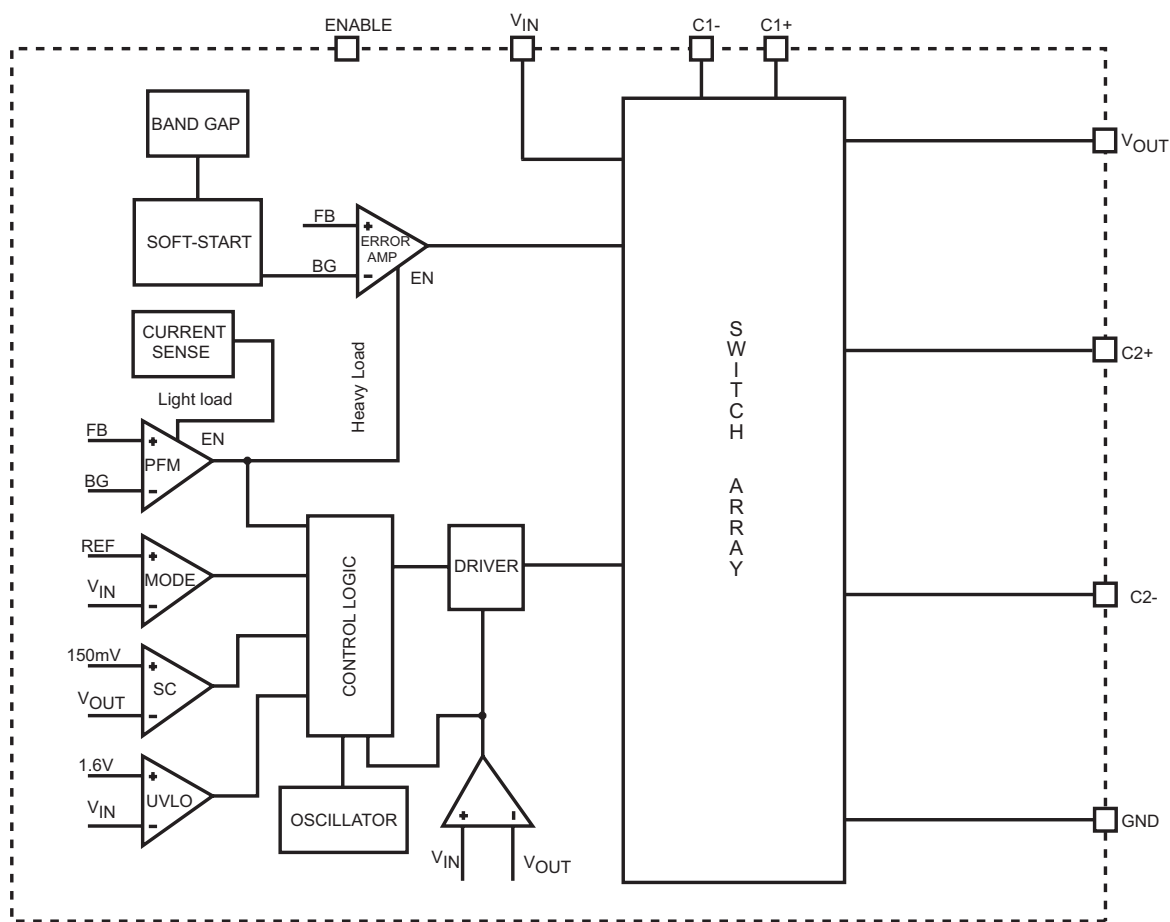

Figure 2. Block Diagram

Pin Assignments

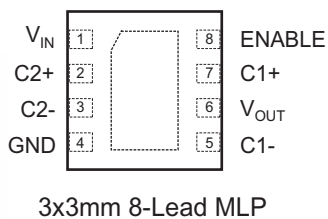

Figure 3. Pin Assignments

Pin Descriptions

Pin #	Name	Description
1	V_{IN}	Supply Voltage Input.
2	C2+	Bucket Capacitor2. Positive Connection.
3	C2-	Bucket Capacitor2. Negative Connection.
4	GND	Ground
5	C1-	Bucket Capacitor1. Negative Connection.
6	V_{OUT}	Regulated Output Voltage. Bypass this pin with 10 μ F ceramic low-ESR capacitor.
7	C1+	Bucket Capacitor1. Positive Connection.
8	ENABLE	Enable Input. Logic high enables the chip and logic low disables the chip, reducing the supply current to less than 1 μ A. Do not float this pin.

Absolute Maximum Ratings

Stresses exceeding the absolute maximum ratings may damage the device. The device may not function or be operable above the recommended operating conditions and stressing the parts to these levels is not recommended. In addition, extended exposure to stresses above the recommended operating conditions may affect device reliability. The absolute maximum ratings are stress ratings only.

Symbol	Parameter	Min.	Max.	Unit
V_{IN}	V_{IN} , V_{OUT} , ENABLE, Voltage to GND	-3.0	6.0	V
	Voltage at C1+, C1-, C2+, and C2-to GND	-3.0	$V_{IN} + 0.3$	V
P_D	Power Dissipation		Internally Limited	
T_L	Lead Soldering Temperature (10 seconds)		300	C°
T_J	Junction Temperature		150	C°
T_{STG}	Storage Temperature	-55	150	C°
ESD	Human Body Model (HBM)		2	kV
	Charged Device Model (CDM)		2	kV

Note:

2. Using Mil Std. 883E, method 3015.7 (Human Body Model) and EIAJ/JESD22C101-A (Charged Device Model).

Recommended Operating Conditions

The Recommended Operating Conditions table defines the conditions for actual device operation. Recommended operating conditions are specified to ensure optimal performance to the datasheet specifications. Fairchild does not recommend exceeding them or designing to Absolute Maximum Ratings.

Symbol	Parameter	Condition	Min.	Typ.	Max.	Unit
V_{IN}	Input Voltage		1.8		5.5	V
I_L	Load Current	$V_{IN} < 2V$			30	mA
		4.5 & 5.5, $V_{IN} = 3.6V$			100	
T_A	Ambient Temperature		-40		+85	C°

Note:

3. Refer to Figure 9 in Typical Performance Characteristics.

DC Electrical Characteristics

$V_{IN} = 2.7V$ to $5.5V$, $C_1 = C_2 = 1\mu F$, $C_{IN} = C_{OUT} = 10\mu F$, $ENABLE = V_{IN}$, $T_A = -40^{\circ}C$ to $+85^{\circ}C$ unless otherwise noted. Typical values are at $T_A = 25^{\circ}C$.

Symbol	Parameter	Condition	Min.	Typ.	Max.	Unit
V_{UVLO}	Input Under-Voltage Lockout		1.5	1.7	2.2	v
V_{OUT}	Output Voltage	$V_{IN} \geq 0.75 \times V_{NOM}$, $0mA < I_{LOAD} < 100mA$	$0.97 \times V_{NOM}$	V_{NOM}	$1.03 \times V_{NOM}$	V
I_Q	Quiescent Current	$V_{IN} \geq 1.1 \times V_{NOM}$, $I_{LOAD} = 0mA$		170	300	μA
	Off Mode Supply Current	$ENABLE = GND$		0.1	1.0	μA
	Output Short-Circuit	$V_{OUT} < 150mV$			200	mA
	Efficiency	$V_{IN} = 0.85 \times V_{NOM}$, $I_{LOAD} = 30mA$	4.5, 5.0V	80		%
		$V_{IN} = 1.1 \times V_{NOM}$, $I_{LOAD} = 30mA$	4.5, 5.0V	92		
f_{OSC}	Oscillator Frequency	$T_A = 25^{\circ}C$	0.7	1.0	1.3	MHz
T_{SD}	Thermal Shutdown Threshold			145		$^{\circ}C$
T_{SDHYS}	Thermal Shutdown Threshold Hysteresis			15		$^{\circ}C$
V_{IH}	ENABLE Logic Input High Voltage		1.5			V
V_{IL}	ENABLE Logic Input Low Voltage				0.5	V
I_{EN}	ENABLE Logic Input Bias Current	$ENABLE = V_{IN}$ or GND	-1		1	μA
t_{ON}	V_{OUT} Turn-On Time	$V_{IN} = 0.9 \times V_{NOM}$, $I_{LOAD} = 0mA$, 10% to 90%		0.5		ms
	V_{OUT} Ripple	$V_{IN} = 2.5V$, $I_{LOAD} = 200mA$		10		mVpp

Typical Performance Characteristics

$T_A = 25^\circ\text{C}$, $V_{OUT} = 4.5\text{V}$ unless otherwise noted.

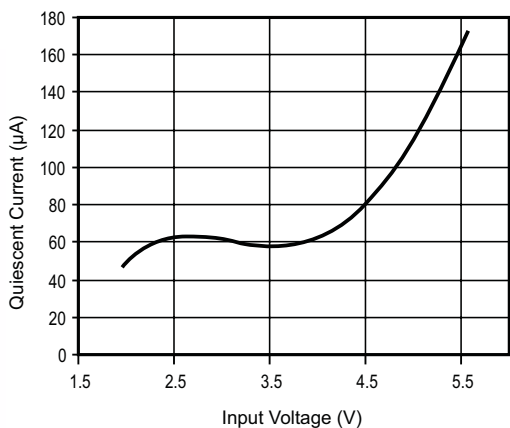

Figure 4. Quiescent Current vs. Input Voltage

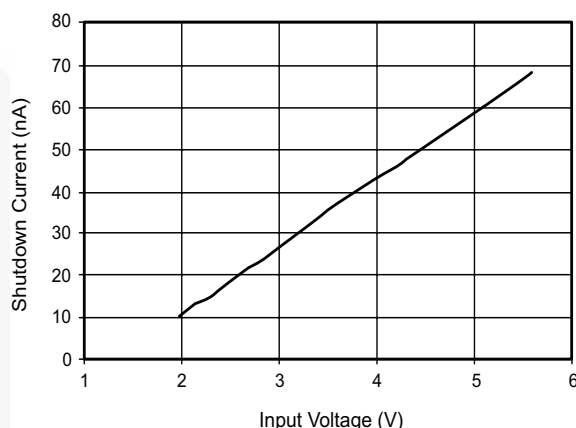

Figure 5. Shutdown Current vs. Input Voltage

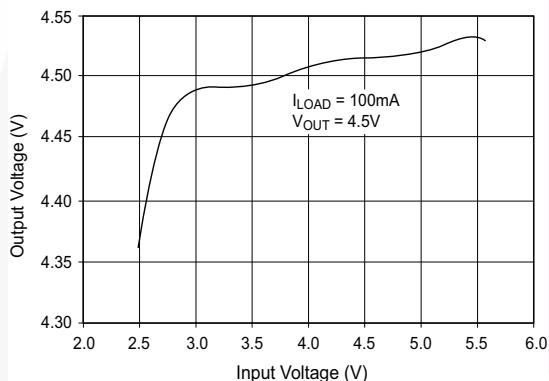

Figure 6. Line Regulation

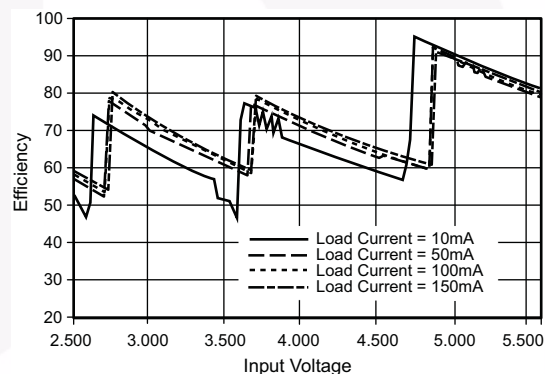

Figure 7. Efficiency vs. Input Voltage

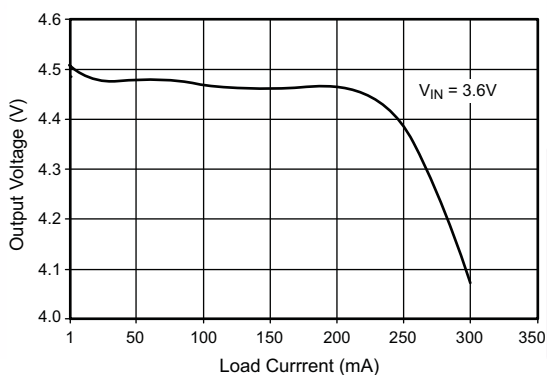

Figure 8. Load Regulation

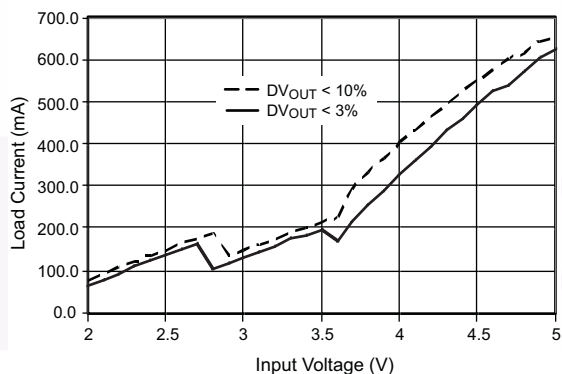

Figure 9. Output Current Capacity vs. Input Voltage

Typical Performance Characteristics (Continued)

$T_A = 25^\circ\text{C}$ and $V_{OUT} = 4.5\text{V}$ unless otherwise noted.

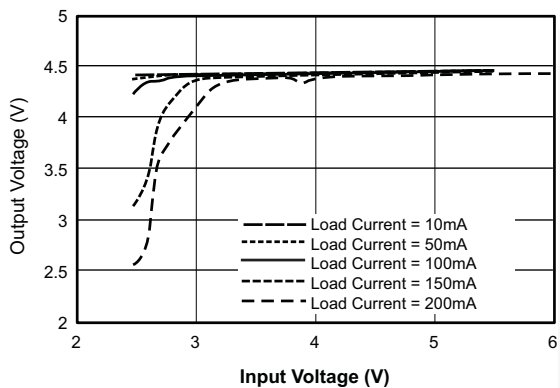

Figure 10. Output Voltage vs. Input Voltage

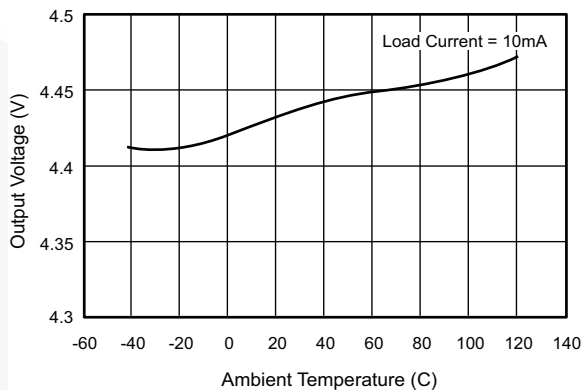

Figure 11. Output Voltage vs. Ambient Temperature

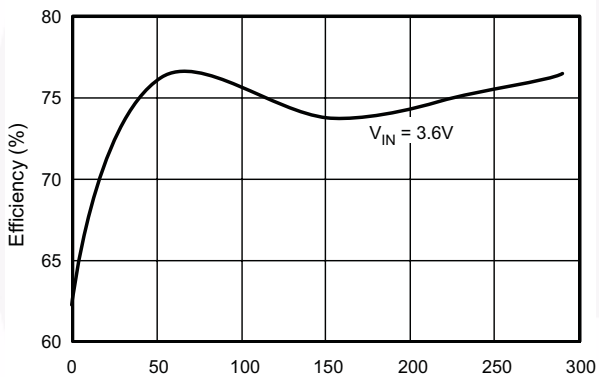

Figure 12. Peak Efficiency vs. Load Current

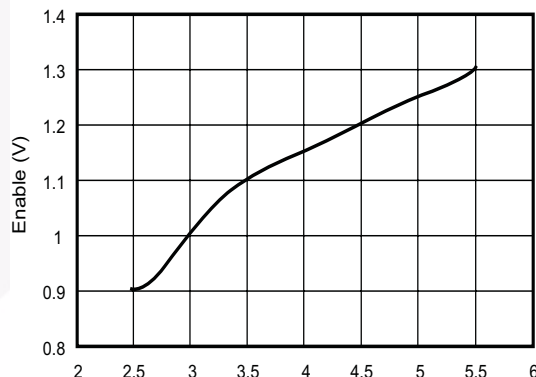

Figure 13. Enable Threshold vs. Input Voltage

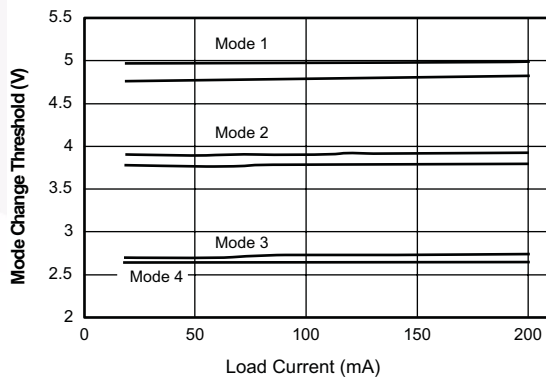

Figure 14. Mode Change Threshold and Hysteresis

Typical Performance Characteristics (Continued)

$T_A = 25^\circ\text{C}$, $C_{IN} = C_{OUT} = 10\mu\text{F}$, $C_B = 1\mu\text{F}$, $V_{OUT} = 4.5\text{V}$ unless otherwise noted.

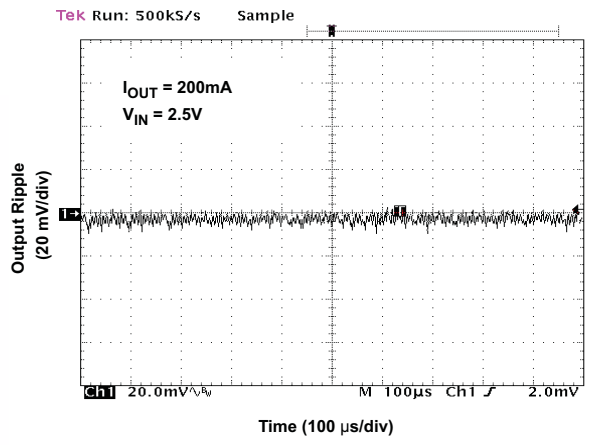

Figure 15. Output Ripple

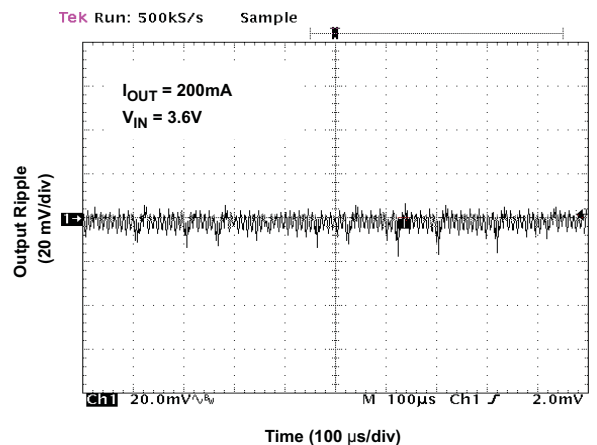

Figure 16. Output Ripple

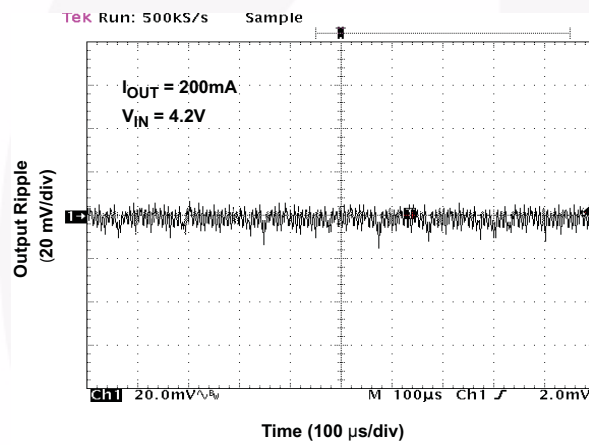

Figure 17. Output Ripple

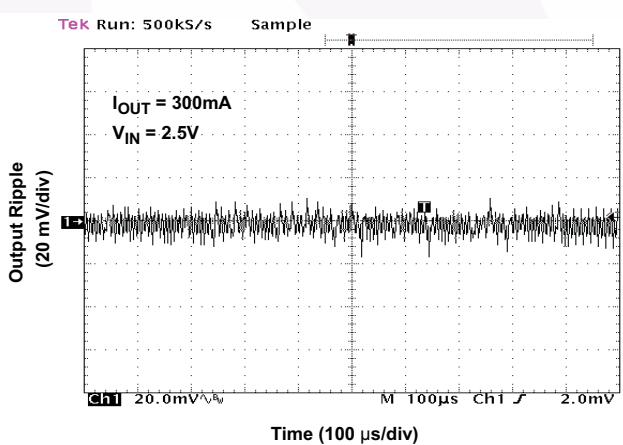

Figure 18. Output Ripple

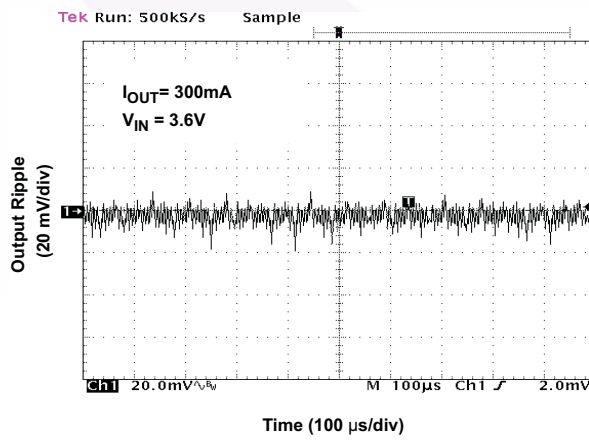

Figure 19. Output Ripple

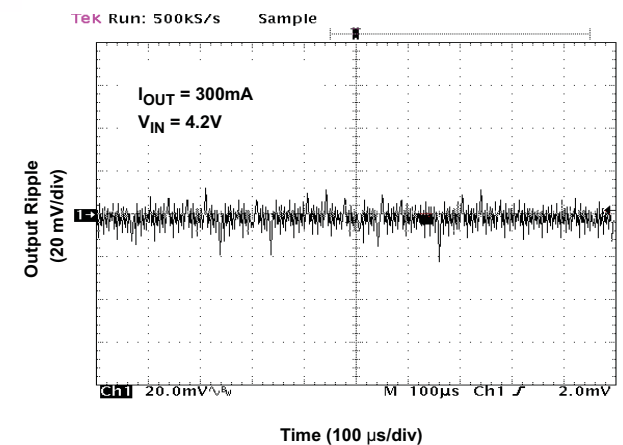

Figure 20. Output Ripple

Functional Description

FAN5602 is a high-efficiency, low-noise switched capacitor DC/DC converter capable of step-up and step-down operations. It has seven built-in switch configurations. Based on the ratio of the input voltage to the output voltage, the FAN5602 automatically reconfigures the switch to achieve the highest efficiency. The regulation of the output is achieved by a linear regulation loop, which modulates the on-resistance of the power transistors so that the amount of charge transferred from the input to the flying capacitor at each clock cycle is controlled and is equal to the charge needed by the load. The current spike is reduced to minimum. At light load, the FAN5602 automatically switches to Pulse Frequency Modulation (PFM) mode to save power. The regulation at PFM mode is achieved by skipping pulses.

Linear Regulation Loop

The FAN5602 operates at constant frequency at load higher than 10mA. The linear regulation loop consisting of power transistors, feedback (resistor divider), and error amplifier is used to realize the regulation of the output voltage and to reduce the current spike. The error amplifier takes feedback and reference as inputs and generates the error voltage signal. The error voltage signal is then used as the gate voltage of the power transistor and modulates the on-resistance of the power transistor and, therefore, the charge transferred from the input to the output is controlled and the regulation of the output is realized. Since the charge transfer is controlled, the FAN5602 has a small ESR spike.

Switch Array

Switch Configurations

The FAN5602 has seven built-in switch configurations, including 1:1, 3:2, 2:1 and 3:1 for step-down and 2:3, 1:2 and 1:3 for step-up.

When $1.5 \times V_{OUT} > V_{IN} > V_{OUT}$, the 1:1 mode shown in Figure 21 is used. In this mode, the internal oscillator is turned off. The power transistors connecting the input and the output become pass transistors and their gate voltages are controlled by the linear regulation loop, the rest of power transistors are turned off. In this mode, the FAN5602 operates exactly like a low dropout (LDO) regulator and the ripple of the output is in the micro-volt range.

When $1.5 \times V_{IN} > V_{OUT} > V_{IN}$, the 2:3 mode (step-up) shown in Figure 22 is used. In the charging phase, two flying capacitors are placed in series and each capacitor is charged to a half of the input voltage. In pumping phase, the flying capacitors are placed in parallel. The

input is connected to the bottom the capacitors so that the top of the capacitors is boosted to a voltage that equals $V_{IN}/2 + V_{IN}$, i.e., $3/2 \times V_{IN}$. By connecting the top of the capacitors to the output, one can ideally charge the output to $3/2 \times V_{IN}$. If $3/2 \times V_{IN}$ is higher than the needed V_{OUT} , the linear regulation loop adjusts the on-resistance to drop some voltage. Boosting the voltage of the top of the capacitors to $3/2 \times V_{IN}$ by connecting V_{IN} the bottom of the capacitors, boosts the power efficiency $3/2$ times. In 2:3 mode, the ideal power efficiency is $V_{OUT}/1.5 \times V_{IN}$. For example, if $V_{IN} = 2V$, $V_{OUT} = 2 \times V_{IN} = 4V$, the ideal power efficiency is 100%.

When $2 \times V_{IN} > V_{OUT} > 1.5 \times V_{IN}$, the 1:2 mode (step-up) shown in Figure 23 is used. Both in the charging phase and in pumping phase, two flying capacitors are placed in parallel. In charging phase, the capacitors are charged to the input voltage. In the pumping phase, the input voltage is placed to the bottom of the capacitors. The top of the capacitors is boosted to $2 \times V_{IN}$. By connecting the top of the capacitors to the output, one can ideally charge the output to $2 \times V_{IN}$. Boosting the voltage on the top of the capacitors to $2V_{IN}$ boosts the power efficiency 2 times. In 1:2 mode, the ideal power efficiency is $V_{OUT}/2 \times V_{IN}$. For example, $V_{IN} = 2V$, $V_{OUT} = 2 \times V_{IN} = 4V$, the ideal power efficiency is 100%.

When $3 \times V_{IN} > V_{OUT} > 2 \times V_{IN}$, the 1:3 mode (step-up) shown in Figure 24 is used. In charging phase, two flying capacitors are placed in parallel and each is charged to V_{IN} . In the pumping phase, the two flying capacitors are placed in series and the input is connected to the bottom of the series connected capacitors. The top of the series connected capacitors is boosted to $3 \times V_{IN}$. The ideal power efficiency is boosted 3 times and is equal to $V_{OUT}/3V_{IN}$. For example, $V_{IN} = 1V$, $V_{OUT} = 3 \times V_{IN} = 3V$, the ideal power efficiency is 100%. By connecting the output to the top of the series connected capacitors, one can charge the output to $3 \times V_{IN}$.

The internal logic in the FAN5602 monitors the input and the output compares them, and automatically selects the switch configuration to achieve the highest efficiency.

The step-down modes 3:2, 2:1, and 3:1 can be understood by reversing the function of V_{IN} and V_{OUT} in the above discussion.

The built-in modes improve power efficiency and extend the battery life. For example, if $V_{OUT} = 5V$, mode 1:2 needs a minimum $V_{IN} = 2.5V$. By built-in 1:3 mode, the minimum battery voltage is extended to 1.7V.

Switch Array Modes

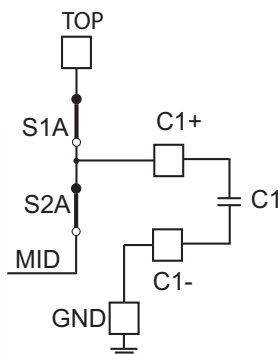

Figure 21. Mode 1 (1:1)

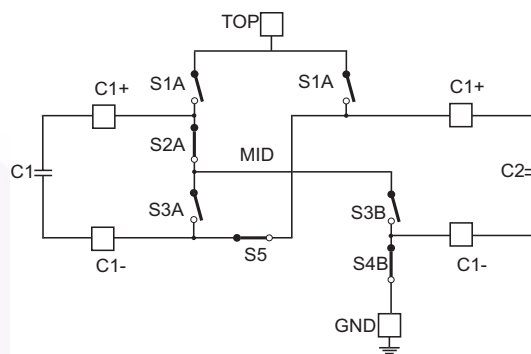

Figure 22. Mode 2 (2:3 or 3:2) All Switches Set for Phase 1 and Reverse State for Phase 2

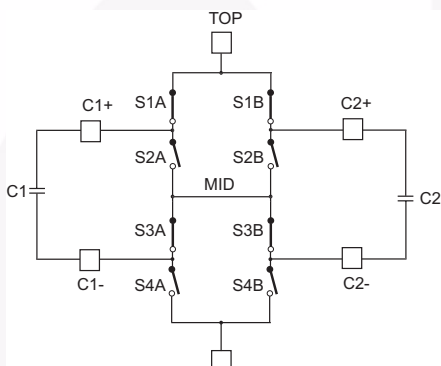

Figure 23. Mode 3 (1:2 or 2:1) All Switches Set for Phase 1 and Reverse State for Phase 2

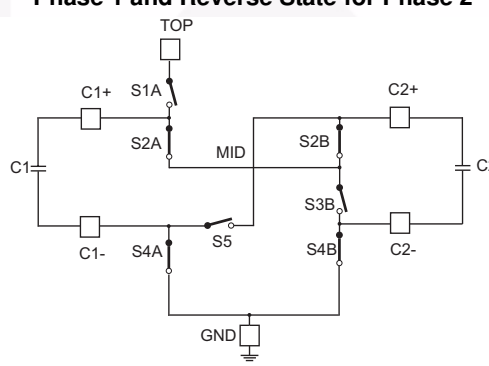

Figure 24. Mode 4 (1:3 or 3:1) All Switches Set for Phase 1 and Reverse State for Phase 2

Light-Load Operation

The power transistors used in the charge pump are very large in size. The dynamic loss from the switching the power transistors is not small and increases its proportion of the total power consumption as the load gets light. To save power, the FAN5602 switches, when the load is less than 10mA, from constant frequency to pulse-skipping mode (PFM) for modes 2:3(3:2), 1:2(2:1) and 1:3(3:1), except mode 1:1. In PFM mode, the linear loop is disabled and the error amplifier is turned off. A PFM comparator is used to setup an upper threshold and a lower threshold for the output. When the output is lower than the lower threshold, the oscillator is turned on and the charge pump starts working and keeps delivering charges from the input to the output until the output is higher than the upper threshold. The oscillator shuts off power transistors and delivers the charge to the output from the output capacitor. PFM operation is not used for Mode 1:1, even if at light load. Mode 1:1 is designed as an LDO with the oscillator off. The power transistors at LDO mode are not switching and therefore do not have the dynamic loss.

Switching from linear operation to PFM mode ($I_{LOAD} < 10\text{mA}$) and from PFM to linear mode ($I_{LOAD} > 10\text{mA}$) is automatic, based on the load current, which is monitored all the time.

Short Circuit

When the output voltage is lower than 150mV, the FAN5602 enters short-circuit condition. In this condition, all power transistors are turned off. A small transistor shorting the input and the output turns on and charges the output. This transistor stays on as long as the $V_{OUT} < 150\text{mV}$. Since this transistor is very small, the current from the input to the output is limited. Once the short at the output is eliminated, this transistor is large enough to charge the output higher than 150mV and the FAN5602 enters soft-start period.

Soft Start

The FAN5602 uses a constant current, charging a low-pass filter to generate a ramp. The ramp is used as reference voltage during the startup. Since the ramp starts at zero and goes up slowly, the output follows the ramp and inrush current is restricted. When the ramp is higher than bandgap voltage, the bandgap voltage supersedes ramp as reference and the soft start is over. The soft start takes about 500 μs .

Thermal Shutdown

The FAN5602 goes to thermal shutdown if the junction temperature is over 150°C with 15°C hysteresis.

Application Information

Using the FAN5602 to Drive LCD Backlighting

The FAN5602 4.5V option is ideal for driving the backlighting and flash LEDs for portable devices. One FAN5602 device can supply the roughly 150mA needed to power both the backlight and the flash LEDs. Even though drawing this much current from the FAN5602 drives the part out of the 3% output regulation, it is not a

problem. The backlight and flash LEDs still produce optimal brightness at the reduced regulation. When building this circuit, use ceramic capacitors with low ESR. All capacitors should be placed as close as possible to the FAN5602 in the PCB layout.

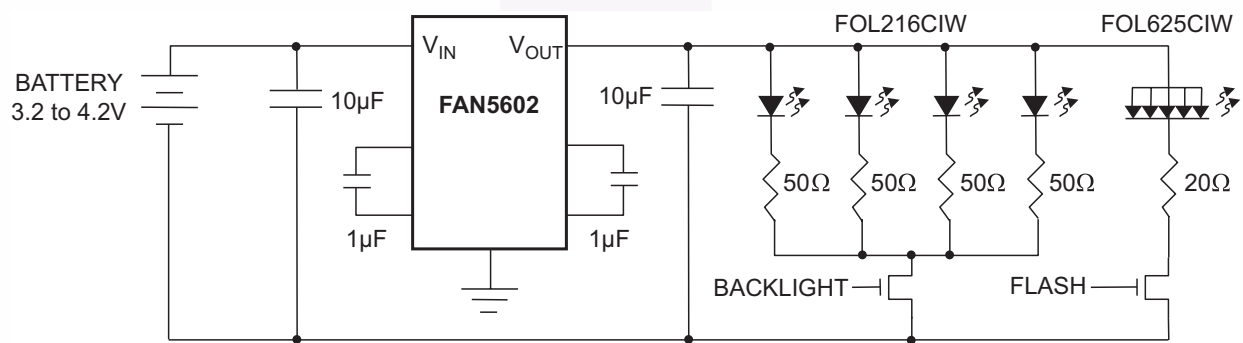
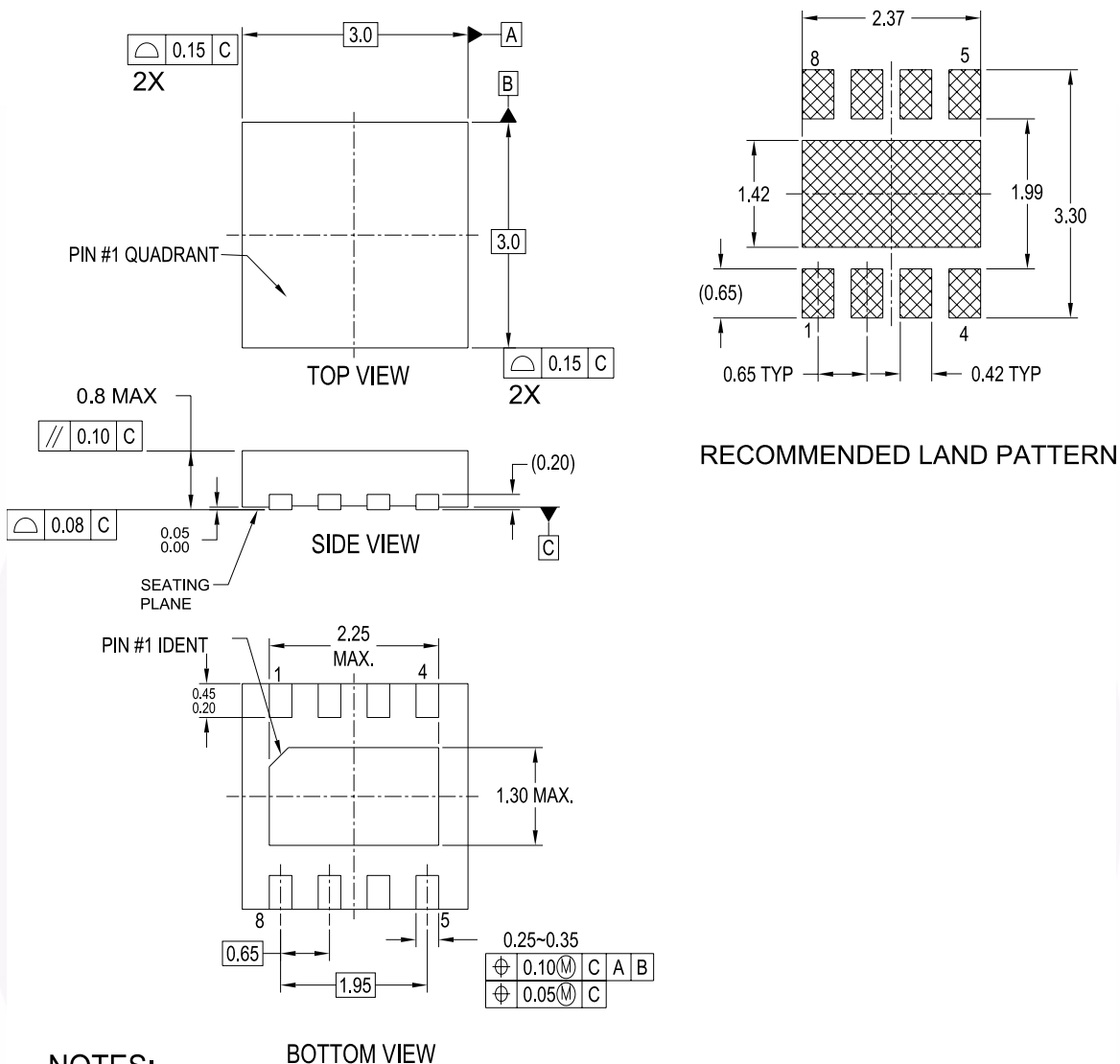

Figure 25. Circuit for Backlighting / Flash Application

Package Dimensions



NOTES:

- A. CONFORMS TO JEDEC REGISTRATION MO-229, VARIATION VEEC, DATED 11/2001
- B. DIMENSIONS ARE IN MILLIMETERS.
- C. DIMENSIONS AND TOLERANCES PER ASME Y14.5M, 1994
- D. FILENAME: MKT-MLP08Drev2

MLP08Drev2

Figure 26. 8-Lead, 3x3mm, Molded Leadless Package (MLP), .8mm Thick

Package drawings are provided as a service to customers considering Fairchild components. Drawings may change in any manner without notice. Please note the revision and/or date on the drawing and contact a Fairchild Semiconductor representative to verify or obtain the most recent revision. Package specifications do not expand the terms of Fairchild's worldwide terms and conditions, specifically the warranty therein, which covers Fairchild products.





Always visit Fairchild Semiconductor's online packaging area for the most recent package drawings:

<http://www.fairchildsemi.com/packaging/>



TRADEMARKS

The following includes registered and unregistered trademarks and service marks, owned by Fairchild Semiconductor and/or its global subsidiaries, and is not intended to be an exhaustive list of all such trademarks.

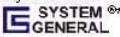
- | | | | |
|---|---|---|---|
| AccuPower™ | FPS™ | PowerTrench® | The Power Franchise® |
| Auto-SPM™ | F-PFS™ | PowerXS™ | the power franchise |
| Build it Now™ | FRFET® | Programmable Active Droop™ | TinyBoost™ |
| CorePLUS™ | Global Power Resource™ | QFET® | TinyBuck™ |
| CorePOWER™ | Green FPS™ | QST™ | TinyCalc™ |
| CROSSVOLT™ | Green FPS™ e-Series™ | Quiet Series™ | TinyLogic® |
| CTL™ | Gmax™ | RapidConfigure™ | TINYOPTO™ |
| Current Transfer Logic™ | GTO™ |  TM | TinyPower™ |
| EcoSPARK® | IntelliMAX™ | Saving our world, 1mW/W/kW at a time™ | TinyPWM™ |
| EfficientMax™ | ISOPLANAR™ | SignalWise™ | TinyWire™ |
| EZSWTCH™ | MegaBuck™ | SmartMax™ | TriFault Detect™ |
|  ™ | MICROCOUPLER™ | SMART START™ | TRUECURRENT™ |
|  ® | MicroFET™ | SPM® | µSerDes™ |
| Fairchild® | MicroPak™ | STEALTH™ |  SerDes™ |
| Fairchild Semiconductor® | MillerDrive™ | SuperFET™ | UHC® |
| FACT Quiet Series™ | MotionMax™ | SuperSOT™.3 | Ultra FRFET™ |
| FACT® | Motion-SPM™ | SuperSOT™.6 | UniFET™ |
| FAST® | OPTOLOGIC® | SuperSOT™.8 | VCX™ |
| FastvCore™ | OPTOPLANAR® | SupreMOS™ | VisualMax™ |
| FETBench™ |  ® | SyncFET™ | XST™ |
| FlashWriter® | PDP SPM™ | Sync-Lock™ | |
| | Power-SPM™ |  SYSTEM GENERAL® | |

* Trademarks of System General Corporation, used under license by Fairchild Semiconductor.

DISCLAIMER

FAIRCHILD SEMICONDUCTOR RESERVES THE RIGHT TO MAKE CHANGES WITHOUT FURTHER NOTICE TO ANY PRODUCTS HEREIN TO IMPROVE RELIABILITY, FUNCTION, OR DESIGN. FAIRCHILD DOES NOT ASSUME ANY LIABILITY ARISING OUT OF THE APPLICATION OR USE OF ANY PRODUCT OR CIRCUIT DESCRIBED HEREIN; NEITHER DOES IT CONVEY ANY LICENSE UNDER ITS PATENT RIGHTS, NOR THE RIGHTS OF OTHERS. THESE SPECIFICATIONS DO NOT EXPAND THE TERMS OF FAIRCHILD'S WORLDWIDE TERMS AND CONDITIONS, SPECIFICALLY THE WARRANTY THEREIN, WHICH COVERS THESE PRODUCTS.

LIFE SUPPORT POLICY

FAIRCHILD'S PRODUCTS ARE NOT AUTHORIZED FOR USE AS CRITICAL COMPONENTS IN LIFE SUPPORT DEVICES OR SYSTEMS WITHOUT THE EXPRESS WRITTEN APPROVAL OF FAIRCHILD SEMICONDUCTOR CORPORATION.

As used herein:

1. Life support devices or systems are devices or systems which, (a) are intended for surgical implant into the body or (b) support or sustain life, and (c) whose failure to perform when properly used in accordance with instructions for use provided in the labeling, can be reasonably expected to result in a significant injury of the user.
2. A critical component in any component of a life support, device, or system whose failure to perform can be reasonably expected to cause the failure of the life support device or system, or to affect its safety or effectiveness.

ANTI-COUNTERFEITING POLICY

Fairchild Semiconductor Corporation's Anti-Counterfeiting Policy. Fairchild's Anti-Counterfeiting Policy is also stated on our external website, www.fairchildsemi.com, under Sales Support.

Counterfeiting of semiconductor parts is a growing problem in the industry. All manufacturers of semiconductor products are experiencing counterfeiting of their parts. Customers who inadvertently purchase counterfeit parts experience many problems such as loss of brand reputation, substandard performance, failed applications, and increased cost of production and manufacturing delays. Fairchild is taking strong measures to protect ourselves and our customers from the proliferation of counterfeit parts. Fairchild strongly encourages customers to purchase Fairchild parts either directly from Fairchild or from Authorized Fairchild Distributors who are listed by country on our web page cited above. Products customers buy either from Fairchild directly or from Authorized Fairchild Distributors are genuine parts, have full traceability, meet Fairchild's quality standards for handling and storage and provide access to Fairchild's full range of up-to-date technical and product information. Fairchild and our Authorized Distributors will stand behind all warranties and will appropriately address any warranty issues that may arise. Fairchild will not provide any warranty coverage or other assistance for parts bought from Unauthorized Sources. Fairchild is committed to combat this global problem and encourage our customers to do their part in stopping this practice by buying direct or from authorized distributors.

PRODUCT STATUS DEFINITIONS

Definition of Terms

Datasheet Identification	Product Status	Definition
Advance Information	Formative / In Design	Datasheet contains the design specifications for product development. Specifications may change in any manner without notice.
Preliminary	First Production	Datasheet contains preliminary data; supplementary data will be published at a later date. Fairchild Semiconductor reserves the right to make changes at any time without notice to improve design.
No Identification Needed	Full Production	Datasheet contains final specifications. Fairchild Semiconductor reserves the right to make changes at any time without notice to improve the design.
Obsolete	Not In Production	Datasheet contains specifications on a product that is discontinued by Fairchild Semiconductor. The datasheet is for reference information only.

Rev. I42

ON Semiconductor and  are trademarks of Semiconductor Components Industries, LLC dba ON Semiconductor or its subsidiaries in the United States and/or other countries. ON Semiconductor owns the rights to a number of patents, trademarks, copyrights, trade secrets, and other intellectual property. A listing of ON Semiconductor's product/patent coverage may be accessed at www.onsemi.com/site/pdf/Patent-Marking.pdf. ON Semiconductor reserves the right to make changes without further notice to any products herein. ON Semiconductor makes no warranty, representation or guarantee regarding the suitability of its products for any particular purpose, nor does ON Semiconductor assume any liability arising out of the application or use of any product or circuit, and specifically disclaims any and all liability, including without limitation special, consequential or incidental damages. Buyer is responsible for its products and applications using ON Semiconductor products, including compliance with all laws, regulations and safety requirements or standards, regardless of any support or applications information provided by ON Semiconductor. "Typical" parameters which may be provided in ON Semiconductor data sheets and/or specifications can and do vary in different applications and actual performance may vary over time. All operating parameters, including "Typicals" must be validated for each customer application by customer's technical experts. ON Semiconductor does not convey any license under its patent rights nor the rights of others. ON Semiconductor products are not designed, intended, or authorized for use as a critical component in life support systems or any FDA Class 3 medical devices or medical devices with a same or similar classification in a foreign jurisdiction or any devices intended for implantation in the human body. Should Buyer purchase or use ON Semiconductor products for any such unintended or unauthorized application, Buyer shall indemnify and hold ON Semiconductor and its officers, employees, subsidiaries, affiliates, and distributors harmless against all claims, costs, damages, and expenses, and reasonable attorney fees arising out of, directly or indirectly, any claim of personal injury or death associated with such unintended or unauthorized use, even if such claim alleges that ON Semiconductor was negligent regarding the design or manufacture of the part. ON Semiconductor is an Equal Opportunity/Affirmative Action Employer. This literature is subject to all applicable copyright laws and is not for resale in any manner.

PUBLICATION ORDERING INFORMATION

LITERATURE FULFILLMENT:

Literature Distribution Center for ON Semiconductor
19521 E. 32nd Pkwy, Aurora, Colorado 80011 USA
Phone: 303-675-2175 or 800-344-3860 Toll Free USA/Canada
Fax: 303-675-2176 or 800-344-3867 Toll Free USA/Canada
Email: orderlit@onsemi.com

N. American Technical Support: 800-282-9855 Toll Free
USA/Canada
Europe, Middle East and Africa Technical Support:
Phone: 421 33 790 2910
Japan Customer Focus Center
Phone: 81-3-5817-1050

ON Semiconductor Website: www.onsemi.com
Order Literature: <http://www.onsemi.com/orderlit>
For additional information, please contact your local
Sales Representative