



Chipsmall Limited consists of a professional team with an average of over 10 year of expertise in the distribution of electronic components. Based in Hongkong, we have already established firm and mutual-benefit business relationships with customers from,Europe,America and south Asia,supplying obsolete and hard-to-find components to meet their specific needs.

With the principle of “Quality Parts,Customers Priority,Honest Operation,and Considerate Service”,our business mainly focus on the distribution of electronic components. Line cards we deal with include Microchip,ALPS,ROHM,Xilinx,Pulse,ON,Everlight and Freescale. Main products comprise IC,Modules,Potentiometer,IC Socket,Relay,Connector.Our parts cover such applications as commercial,industrial, and automotives areas.

We are looking forward to setting up business relationship with you and hope to provide you with the best service and solution. Let us make a better world for our industry!



Contact us

Tel: +86-755-8981 8866 Fax: +86-755-8427 6832

Email & Skype: info@chipsmall.com Web: www.chipsmall.com

Address: A1208, Overseas Decoration Building, #122 Zhenhua RD., Futian, Shenzhen, China





Is Now Part of



ON Semiconductor®

To learn more about ON Semiconductor, please visit our website at

www.onsemi.com

ON Semiconductor and the ON Semiconductor logo are trademarks of Semiconductor Components Industries, LLC dba ON Semiconductor or its subsidiaries in the United States and/or other countries. ON Semiconductor owns the rights to a number of patents, trademarks, copyrights, trade secrets, and other intellectual property. A listing of ON Semiconductor's product/patent coverage may be accessed at www.onsemi.com/site/pdf/Patent-Marking.pdf. ON Semiconductor reserves the right to make changes without further notice to any products herein. ON Semiconductor makes no warranty, representation or guarantee regarding the suitability of its products for any particular purpose, nor does ON Semiconductor assume any liability arising out of the application or use of any product or circuit, and specifically disclaims any and all liability, including without limitation special, consequential or incidental damages. Buyer is responsible for its products and applications using ON Semiconductor products, including compliance with all laws, regulations and safety requirements or standards, regardless of any support or applications information provided by ON Semiconductor. "Typical" parameters which may be provided in ON Semiconductor data sheets and/or specifications can and do vary in different applications and actual performance may vary over time. All operating parameters, including "Typicals" must be validated for each customer application by customer's technical experts. ON Semiconductor does not convey any license under its patent rights nor the rights of others. ON Semiconductor products are not designed, intended, or authorized for use as a critical component in life support systems or any FDA Class 3 medical devices or medical devices with a same or similar classification in a foreign jurisdiction or any devices intended for implantation in the human body. Should Buyer purchase or use ON Semiconductor products for any such unintended or unauthorized application, Buyer shall indemnify and hold ON Semiconductor and its officers, employees, subsidiaries, affiliates, and distributors harmless against all claims, costs, damages, and expenses, and reasonable attorney fees arising out of, directly or indirectly, any claim of personal injury or death associated with such unintended or unauthorized use, even if such claim alleges that ON Semiconductor was negligent regarding the design or manufacture of the part. ON Semiconductor is an Equal Opportunity/Affirmative Action Employer. This literature is subject to all applicable copyright laws and is not for resale in any manner.

FAN5902

800mA Buck Converter for 3G RFPAs

Features

- 92% Efficient Synchronous Operation
- 2.7V to 5.5V Input Voltage Range
- V_{OUT} Range from 0.4V to 3.4V (or V_{IN})
- Up to 800mA Output Current
- 20 μ s Step Response
- 30 μ s Bypass Transition Time
- 50m Ω Integrated Bypass FET with Controlled Slew Rate for Low Battery Voltage Operation
- 6MHz PWM Operation Allows 470nH Small Form Factor Inductor
- 100% Duty Cycle for Low Dropout Operation
- Thermal Shutdown
- Input Under-Voltage Lockout
- 12-Lead MLP (0.8mm Maximum)
- 12-Bump WLCSP

Applications

- Battery-Powered 3G RFPAs
- Multiband/Multimode WCDMA/CDMA Handset RF Transceivers
- RF PC Cards
- Pocket PC and PDAs with Communication Capabilities

Description

The FAN5902 is a high-efficiency, low-noise, synchronous, step-down DC-to-DC converter designed for powering the radio frequency power amplifiers (RFPAs) in 3G mobile handsets and other mobile applications. It provides up to 800mA of output current over an input voltage range of 2.7V to 5.5V. The output voltage can be dynamically adjusted from 0.4V up to 3.4V, proportional to an analog input voltage ranging from 0.2V to 1.7V provided by an external DAC. This allows supplying the RFPAs with the voltage level that provides optimum Power Added Efficiency (PAE).

An integrated bypass FET automatically switches on when the battery voltage drops too close to the output voltage (when $V_{OUT}=V_{BAT}-250mV$). The bypass transition is controlled by a slew rate controller to limit the inrush current and reduce the RFPAs gain deviation.

The FAN5902 offers fast transition times, allowing changes to the output voltage in less than 20 μ s.

The FAN5902 operates at 6MHz, enabling the use of a small, low-value inductor of 470nH. A current-mode control loop with fast transient response ensures excellent line and load regulation.

The FAN5902 improves the RFPAs power efficiency and increases the talk/connection time in 3G handsets.

The FAN5902 is available in a 12-lead MLP package and 12-bump WLCSP.

Important

For complete performance specifications and datasheet, please contact a Fairchild Semiconductor sales representative.

Ordering Information

Part Number	Operating Temperature Range	Package	 Eco Status	Packing Method
FAN5902MPX	-40 to +85°C	12-Lead, 3x3.5mm, Molded Leadless Package (MLP)	RoHS	Tape and Reel
FAN5902UCX	-40 to +85°C	12-Bump, Wafer-Level Chip-Scale Package (WLCSP)	RoHS	Tape and Reel

 For Fairchild's definition of Eco Status, please visit: http://www.fairchildsemi.com/company/green/rohs_green.html.

Application Diagrams

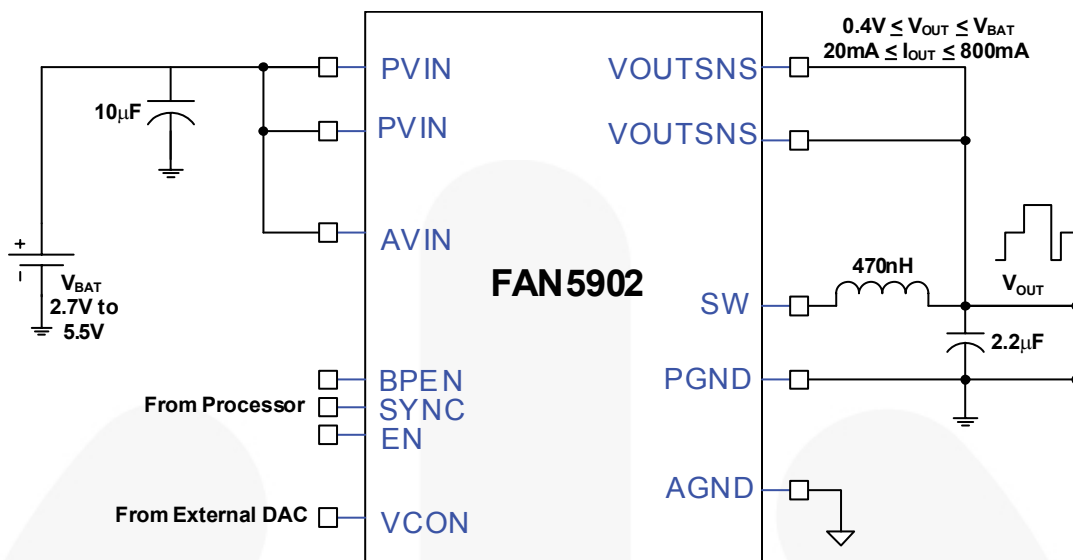

Figure 1. FAN5902 Circuit

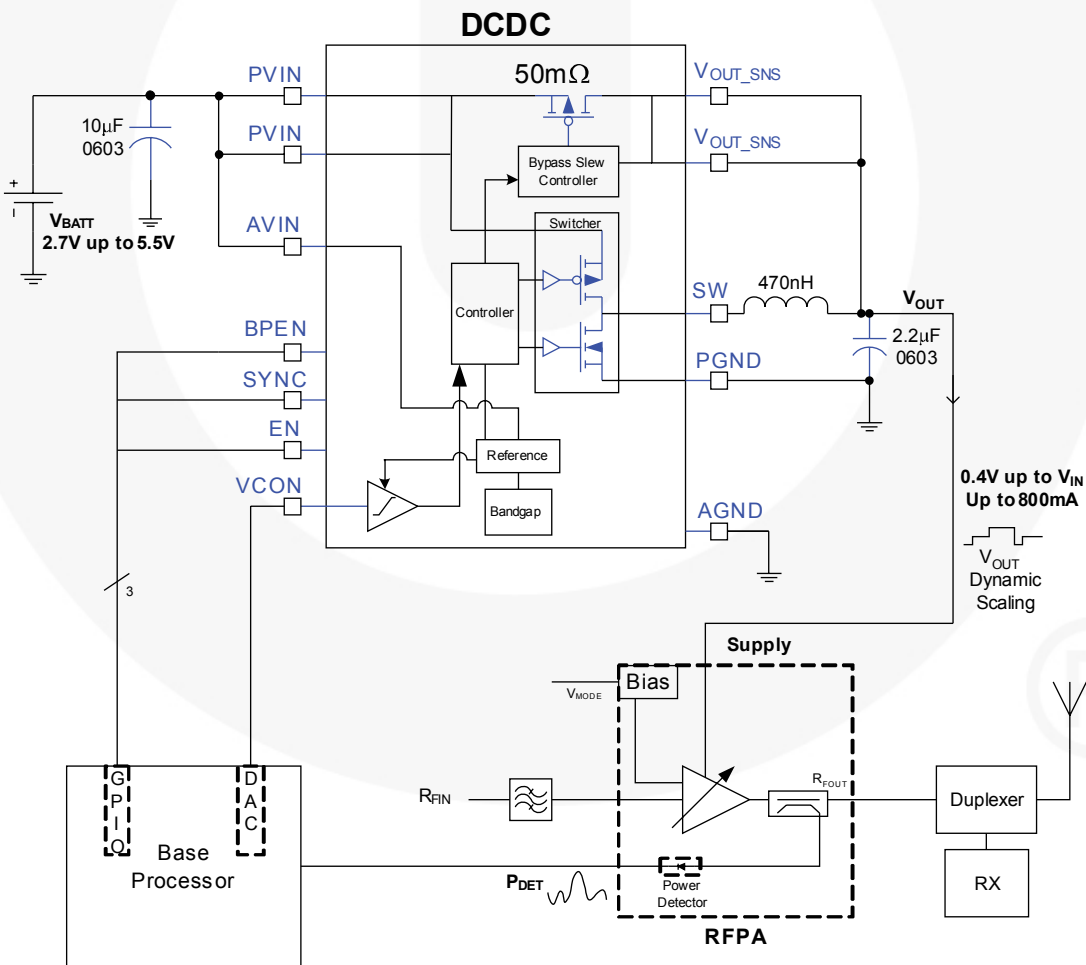

Figure 2. Typical Application

Pin Configurations

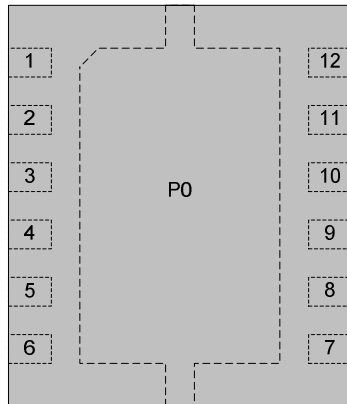

Figure 3. 12-Lead MLP (Top View)

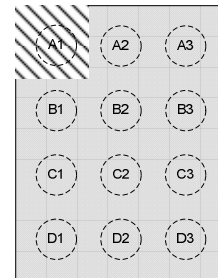

Figure 4. 12-Bump WLCSP (Top View)

Pin Definitions

MLP Pin #	WLCSP Pin #	Name	Description
(*)	(*)	AGND	Analog ground, reference ground for the IC. Follow PCB routing notes for connecting this pin.
		VOUTSNS	Output voltage sense pin. Connect to V_{OUT} to establish feedback path for regulation.
		EN	Enables switcher when HIGH, shutdown mode when LOW. This pin should not be left floating.
		VCON	Analog control input from an external D-to-A converter.
		AVIN	Analog bias supply voltage input. Connect to PVIN.
		AGND	Connect to analog ground.
		BPEN	Force bypass transistor when HIGH; auto-bypass when LOW. This pin should not be left floating
		SYNC	External clock synchronization input and PFM lockout. When SYNC remains HIGH, the DC-to-DC does not allow PFM mode. Tie SYNC to AGND if not used.
		PGND	Power ground of the internal MOSFET switches. Follow routing notes for connections between PGND and AGND.
		SW	Switching node of the internal MOSFET switches. Connect to output inductor.
		PVIN	Supply voltage input to the internal MOSFET switches. Connect to input power source.

(*) Pinout available upon request

Absolute Maximum Ratings

Stresses exceeding the absolute maximum ratings may damage the device. The device may not function or be operable above the recommended operating conditions and stressing the parts to these levels is not recommended. In addition, extended exposure to stresses above the recommended operating conditions may affect device reliability. The absolute maximum ratings are stress ratings only.

Symbol	Parameter	Min.	Max.	Unit
V _{IN}	AVIN, PVIN	-0.3	6.0	V
	Voltage On Any Other Pin	-0.3	AV _{IN} +0.3	
T _J	Junction Temperature	-40	+125	°C
T _{STG}	Storage Temperature	-65	+150	°C
T _L	Lead Soldering Temperature (10 Seconds)		+260	°C
θ _{JC}	Thermal Resistance, Junction to Tab ⁽¹⁾	MLP Package		5 °C/W
θ _{JC}	Thermal Resistance, Junction to Case ⁽¹⁾	WLCSP Package		30 °C/W

1. Refer to θ_{JA} data below.

Recommended Operating Conditions

The Recommended Operating Conditions table defines the conditions for actual device operation. Recommended operating conditions are specified to ensure optimal performance to the datasheet specifications. Fairchild does not recommend exceeding them or designing to Absolute Maximum Ratings.

Symbol	Parameter	Min.	Typ.	Max.	Unit
V _{CC}	Supply Voltage Range	2.7		5.5	V
V _{OUT}	Output Voltage Range	0.4		V _{IN}	V
I _{OUT}	Output Current	20		800	mA
L	Inductor		0.47		μH
C _{IN}	Input Capacitor ⁽²⁾	10			μF
C _{OUT}	Output Capacitor ⁽²⁾	2.2	4.7	10.0	μF
T _A	Operating Ambient Temperature Range	-40		+85	°C
T _J	Operating Junction Temperature Range	-40		+125	°C

Notes:

- A high input capacitor value is required for limiting input voltage drop during bypass transitions or during large output voltage transitions. Ensure the input capacitor value is greater than the output capacitor's. See the *inrush current specifications* below.
- Refer to application note AN-6087 for more details.

Dissipation Ratings⁽⁴⁾

Package	θ _{JA} ⁽⁴⁾	Power Rating at T _A ≤ 25°C ⁽⁵⁾	Derating Factor > T _A =25°C
Molded Leadless Package (MLP)	49°C/W ⁽⁵⁾	2050mW	21mW/°C
Wafer-Level Chip-Scale Package (WLCSP)	110°C/W ⁽⁵⁾	900mW	9mW/°C

Notes:

- Thermal Resistance, Junction-to-Ambient, measured according to JEDEC 2S2P PCB (and zero air flow). θ_{JA} for JEDEC 1S0P PCB (and zero air flow) = 210°C/W.
- Maximum power dissipation is a function of T_{J(max)}, θ_{JA}, and T_A. The maximum allowable power dissipation at any allowable ambient temperature is P_D=[T_{J(max)} - T_A] / θ_{JA}.

Typical Performance Characteristics

Typical performance at 25°C.

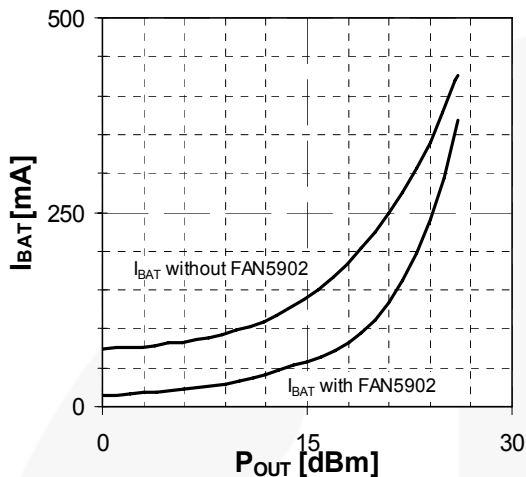

Figure 5. Comparison of RF PA Current Consumption with and without FAN5902

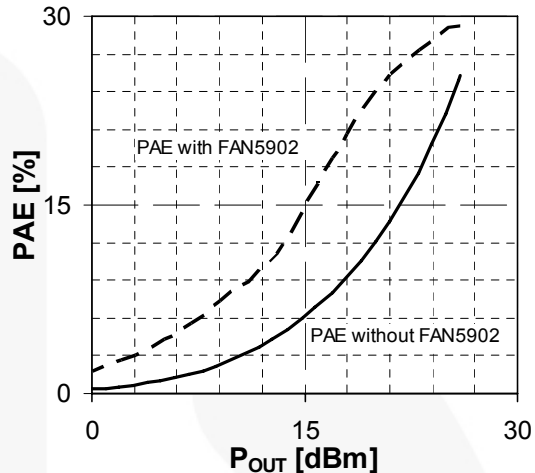

Figure 6. Comparison of RFPA Power Added Efficiency with and without FAN5902

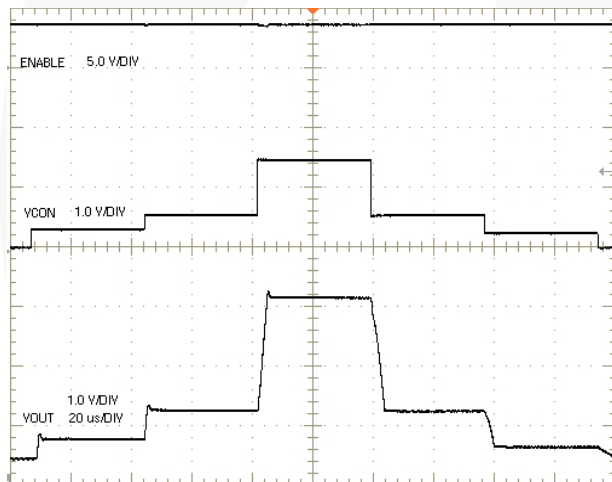

Figure 7. Rise Times for 300mV, 500mV, and 2V ΔV_{OUT}
 $C_{OUT} = 2.2\mu F$ ($V_{IN}=3.7V$)

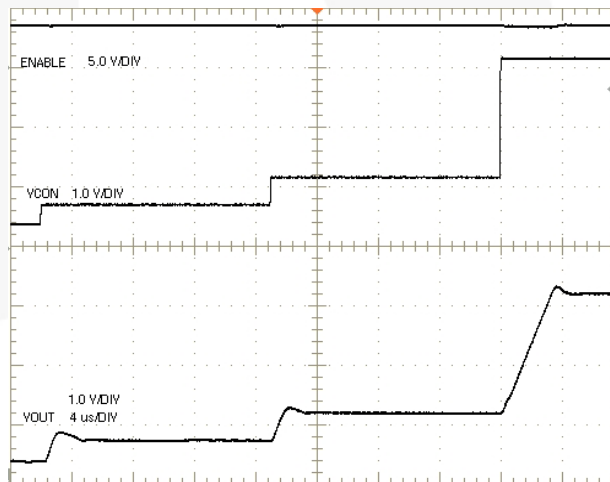

Figure 8. Rise Times for 300mV, 500mV, and 2V ΔV_{OUT}
 $C_{OUT} = 2.2\mu F$ ($V_{IN}=3.7V$)

Physical Dimensions

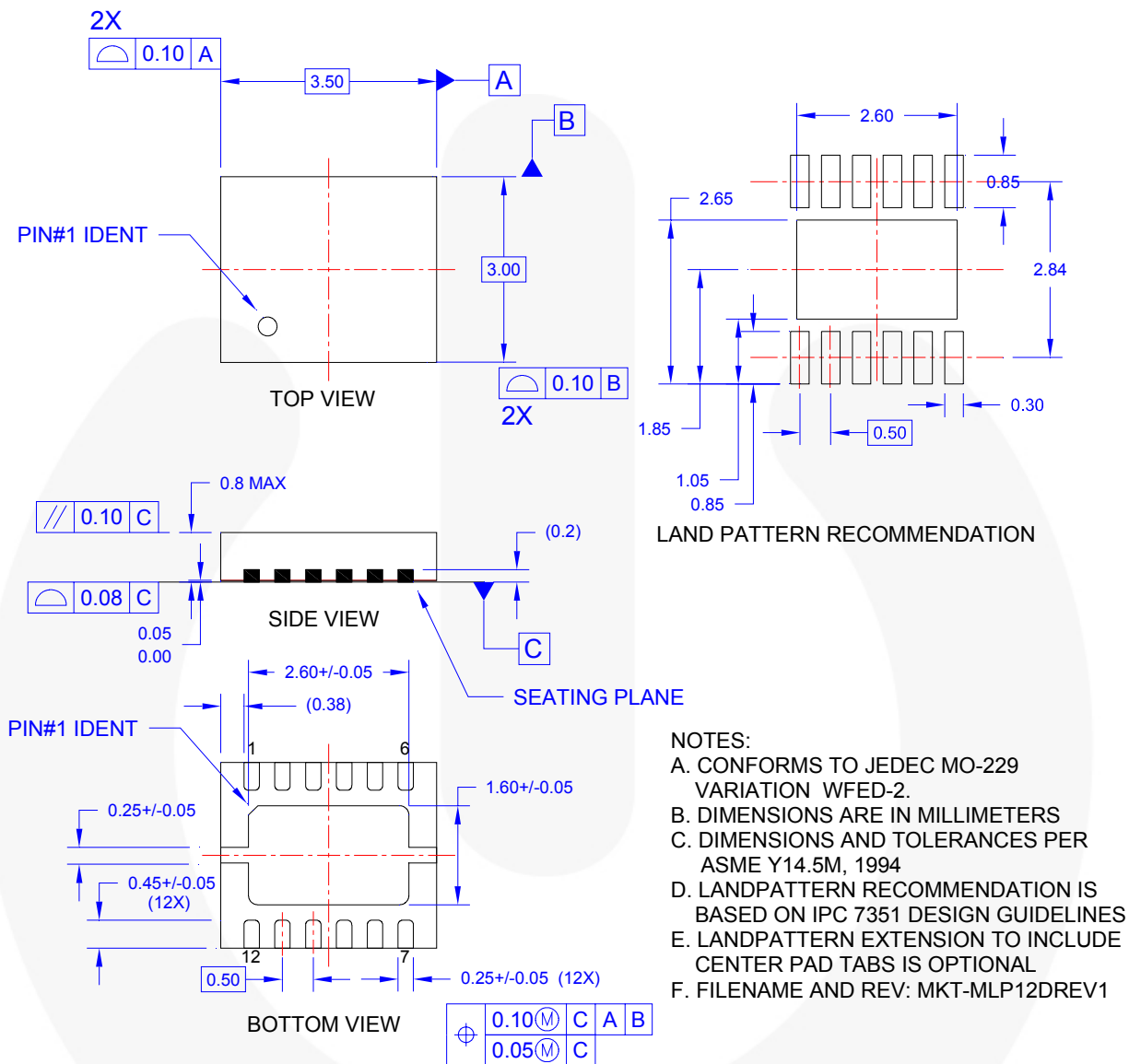

Figure 9: 3x3.5mm 12-Lead MLP

Package drawings are provided as a service to customers considering Fairchild components. Drawings may change in any manner without notice. Please note the revision and/or date on the drawing and contact a Fairchild Semiconductor representative to verify or obtain the most recent revision. Package specifications do not expand the terms of Fairchild's worldwide terms and conditions, specifically the warranty therein, which covers Fairchild products.

Always visit Fairchild Semiconductor's online packaging area for the most recent package drawings:
<http://www.fairchildsemi.com/packaging/>

Physical Dimensions (Continued)

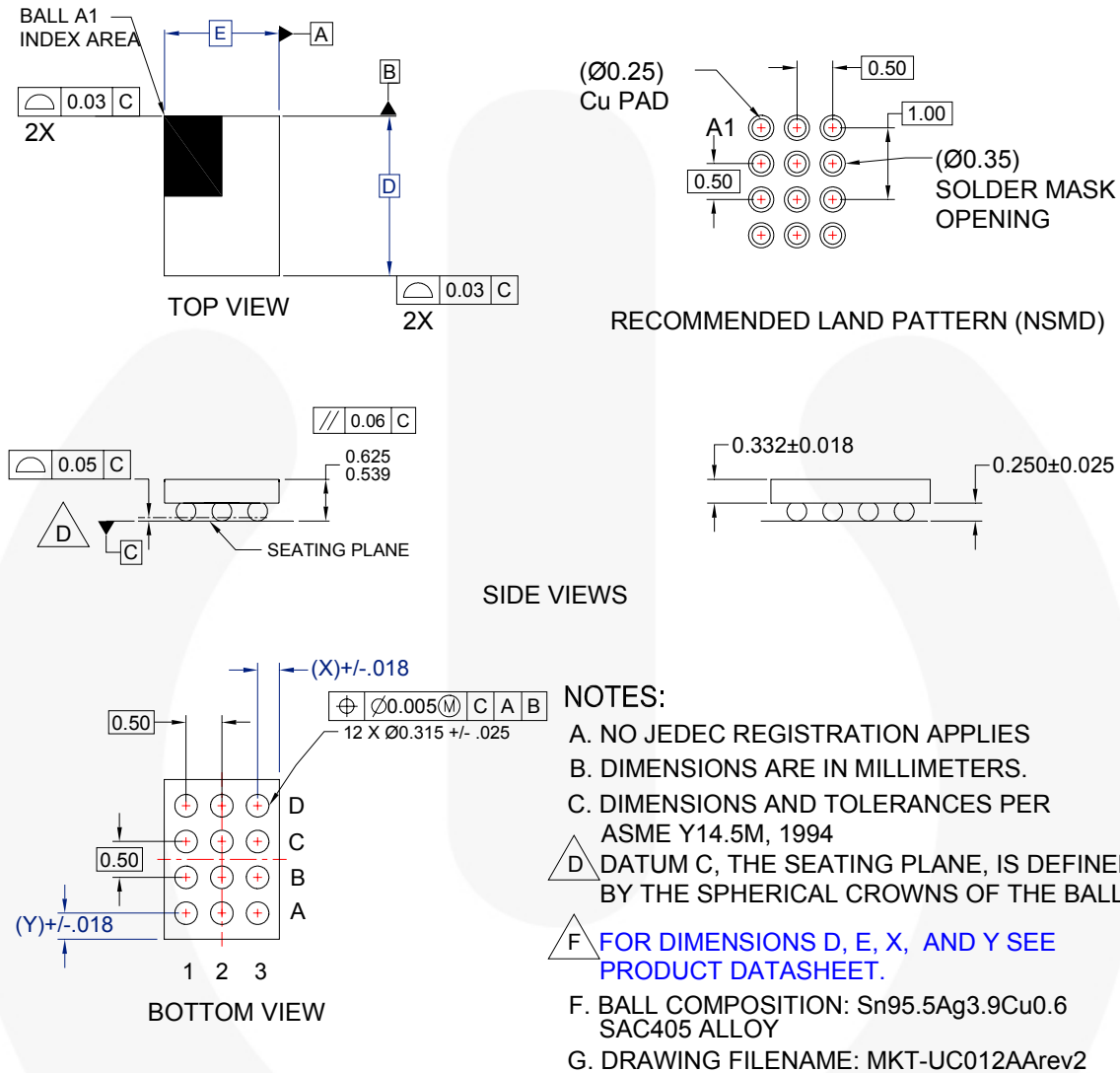

Figure 10. 12-Bump WLCSP







Package drawings are provided as a service to customers considering Fairchild components. Drawings may change in any manner without notice. Please note the revision and/or date on the drawing and contact a Fairchild Semiconductor representative to verify or obtain the most recent revision. Package specifications do not expand the terms of Fairchild's worldwide terms and conditions, specifically the warranty therein, which covers Fairchild products.

Always visit Fairchild Semiconductor's online packaging area for the most recent package drawings:
<http://www.fairchildsemi.com/packaging/>.



TRADEMARKS

The following includes registered and unregistered trademarks and service marks, owned by Fairchild Semiconductor and/or its global subsidiaries, and is not intended to be an exhaustive list of all such trademarks.

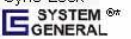
- | | | | |
|---|---|---|---|
| Auto-SPM™ | F-PFST™ | PowerTrench® | The Power Franchise® |
| Build it Now™ | FRFET® | PowerXS™ |  |
| CorePLUS™ | Global Power Resource™ | Programmable Active Droop™ | TinyBoost™ |
| CorePOWER™ | Green FPS™ | QFET® | TinyBuck™ |
| CROSSVOLT™ | Green FPS™ e-Series™ | QST™ | TinyLogic® |
| CTL™ | Gmax™ | Quiet Series™ | TINYOPTO™ |
| Current Transfer Logic™ | GTO™ | RapidConfigure™ | TinyPower™ |
| EcoSPARK® | IntelliMAX™ |  | TinyPWM™ |
| EfficientMax™ | ISOPLANAR™ | Saving our world, 1mW/W/kW at a time™ | TinyWire™ |
| EZSWITCH™ | MegaBuck™ | SmartMax™ | TriFault Detect™ |
|  | MICROCOUPLER™ | SMART START™ | TRUECURRENT™ |
|  | MicroFET™ | SPM® | µSerDes™ |
| Fairchild® | MicroPak™ | STEALTH™ |  |
| Fairchild Semiconductor® | MillerDrive™ | SuperFET™ | UHC® |
| FACT Quiet Series™ | MotionMax™ | SuperSOT™-3 | Ultra FRFET™ |
| FACT® | Motion-SPM™ | SuperSOT™-6 | UniFET™ |
| FAST® | OPTOLOGIC® | SuperSOT™-8 | Vcx™ |
| FastvCore™ | OPTOPLANAR® | SupreMOS™ | VisualMax™ |
| FETBench™ |  | SyncFET™ | XST™ |
| FlashWriter® | PDP SPM™ | Sync-Lock™ | |
| FPS™ | Power-SPM™ |  | |

* Trademarks of System General Corporation, used under license by Fairchild Semiconductor.

DISCLAIMER

FAIRCHILD SEMICONDUCTOR RESERVES THE RIGHT TO MAKE CHANGES WITHOUT FURTHER NOTICE TO ANY PRODUCTS HEREIN TO IMPROVE RELIABILITY, FUNCTION, OR DESIGN. FAIRCHILD DOES NOT ASSUME ANY LIABILITY ARISING OUT OF THE APPLICATION OR USE OF ANY PRODUCT OR CIRCUIT DESCRIBED HEREIN; NEITHER DOES IT CONVEY ANY LICENSE UNDER ITS PATENT RIGHTS, NOR THE RIGHTS OF OTHERS. THESE SPECIFICATIONS DO NOT EXPAND THE TERMS OF FAIRCHILD'S WORLDWIDE TERMS AND CONDITIONS, SPECIFICALLY THE WARRANTY THEREIN, WHICH COVERS THESE PRODUCTS.

LIFE SUPPORT POLICY

FAIRCHILD'S PRODUCTS ARE NOT AUTHORIZED FOR USE AS CRITICAL COMPONENTS IN LIFE SUPPORT DEVICES OR SYSTEMS WITHOUT THE EXPRESS WRITTEN APPROVAL OF FAIRCHILD SEMICONDUCTOR CORPORATION.

As used herein:

1. Life support devices or systems are devices or systems which, (a) are intended for surgical implant into the body or (b) support or sustain life, and (c) whose failure to perform when properly used in accordance with instructions for use provided in the labeling, can be reasonably expected to result in a significant injury of the user.
2. A critical component in any component of a life support, device, or system whose failure to perform can be reasonably expected to cause the failure of the life support device or system, or to affect its safety or effectiveness.

ANTI-COUNTERFEITING POLICY

Fairchild Semiconductor Corporation's Anti-Counterfeiting Policy. Fairchild's Anti-Counterfeiting Policy is also stated on our external website, www.fairchildsemi.com, under Sales Support.

Counterfeiting of semiconductor parts is a growing problem in the industry. All manufacturers of semiconductor products are experiencing counterfeiting of their parts. Customers who inadvertently purchase counterfeit parts experience many problems such as loss of brand reputation, substandard performance, failed applications, and increased cost of production and manufacturing delays. Fairchild is taking strong measures to protect ourselves and our customers from the proliferation of counterfeit parts. Fairchild strongly encourages customers to purchase Fairchild parts either directly from Fairchild or from Authorized Fairchild Distributors who are listed by country on our web page cited above. Products customers buy either from Fairchild directly or from Authorized Fairchild Distributors are genuine parts, have full traceability, meet Fairchild's quality standards for handling and storage and provide access to Fairchild's full range of up-to-date technical and product information. Fairchild and our Authorized Distributors will stand behind all warranties and will appropriately address any warranty issues that may arise. Fairchild will not provide any warranty coverage or other assistance for parts bought from Unauthorized Sources. Fairchild is committed to combat this global problem and encourage our customers to do their part in stopping this practice by buying direct or from authorized distributors.

PRODUCT STATUS DEFINITIONS

Definition of Terms

Datasheet Identification	Product Status	Definition
Advance Information	Formative / In Design	Datasheet contains the design specifications for product development. Specifications may change in any manner without notice.
Preliminary	First Production	Datasheet contains preliminary data; supplementary data will be published at a later date. Fairchild Semiconductor reserves the right to make changes at any time without notice to improve design.
No Identification Needed	Full Production	Datasheet contains final specifications. Fairchild Semiconductor reserves the right to make changes at any time without notice to improve the design.
Obsolete	Not In Production	Datasheet contains specifications on a product that is discontinued by Fairchild Semiconductor. The datasheet is for reference information only.

Rev. 140

ON Semiconductor and  are trademarks of Semiconductor Components Industries, LLC dba ON Semiconductor or its subsidiaries in the United States and/or other countries. ON Semiconductor owns the rights to a number of patents, trademarks, copyrights, trade secrets, and other intellectual property. A listing of ON Semiconductor's product/patent coverage may be accessed at www.onsemi.com/site/pdf/Patent-Marking.pdf. ON Semiconductor reserves the right to make changes without further notice to any products herein. ON Semiconductor makes no warranty, representation or guarantee regarding the suitability of its products for any particular purpose, nor does ON Semiconductor assume any liability arising out of the application or use of any product or circuit, and specifically disclaims any and all liability, including without limitation special, consequential or incidental damages. Buyer is responsible for its products and applications using ON Semiconductor products, including compliance with all laws, regulations and safety requirements or standards, regardless of any support or applications information provided by ON Semiconductor. "Typical" parameters which may be provided in ON Semiconductor data sheets and/or specifications can and do vary in different applications and actual performance may vary over time. All operating parameters, including "Typicals" must be validated for each customer application by customer's technical experts. ON Semiconductor does not convey any license under its patent rights nor the rights of others. ON Semiconductor products are not designed, intended, or authorized for use as a critical component in life support systems or any FDA Class 3 medical devices or medical devices with a same or similar classification in a foreign jurisdiction or any devices intended for implantation in the human body. Should Buyer purchase or use ON Semiconductor products for any such unintended or unauthorized application, Buyer shall indemnify and hold ON Semiconductor and its officers, employees, subsidiaries, affiliates, and distributors harmless against all claims, costs, damages, and expenses, and reasonable attorney fees arising out of, directly or indirectly, any claim of personal injury or death associated with such unintended or unauthorized use, even if such claim alleges that ON Semiconductor was negligent regarding the design or manufacture of the part. ON Semiconductor is an Equal Opportunity/Affirmative Action Employer. This literature is subject to all applicable copyright laws and is not for resale in any manner.

PUBLICATION ORDERING INFORMATION

LITERATURE FULFILLMENT:

Literature Distribution Center for ON Semiconductor
19521 E. 32nd Pkwy, Aurora, Colorado 80011 USA
Phone: 303-675-2175 or 800-344-3860 Toll Free USA/Canada
Fax: 303-675-2176 or 800-344-3867 Toll Free USA/Canada
Email: orderlit@onsemi.com

N. American Technical Support: 800-282-9855 Toll Free
USA/Canada
Europe, Middle East and Africa Technical Support:
Phone: 421 33 790 2910
Japan Customer Focus Center
Phone: 81-3-5817-1050

ON Semiconductor Website: www.onsemi.com
Order Literature: <http://www.onsemi.com/orderlit>
For additional information, please contact your local
Sales Representative