



Chipsmall Limited consists of a professional team with an average of over 10 year of expertise in the distribution of electronic components. Based in Hongkong, we have already established firm and mutual-benefit business relationships with customers from,Europe,America and south Asia,supplying obsolete and hard-to-find components to meet their specific needs.

With the principle of “Quality Parts,Customers Priority,Honest Operation,and Considerate Service”,our business mainly focus on the distribution of electronic components. Line cards we deal with include Microchip,ALPS,ROHM,Xilinx,Pulse,ON,Everlight and Freescale. Main products comprise IC,Modules,Potentiometer,IC Socket,Relay,Connector.Our parts cover such applications as commercial,industrial, and automotives areas.

We are looking forward to setting up business relationship with you and hope to provide you with the best service and solution. Let us make a better world for our industry!



Contact us

Tel: +86-755-8981 8866 Fax: +86-755-8427 6832

Email & Skype: info@chipsmall.com Web: www.chipsmall.com

Address: A1208, Overseas Decoration Building, #122 Zhenhua RD., Futian, Shenzhen, China



FAN7040

3W Mono BTL Amplifier with DC Volume Control

Features

- DC Volume Control : +37dB ~ -52dB
- Few External Components
- Mute Mode
- Thermal Protection
- Short-Circuit Proof
- No Switch-On or Switch-Off Clicks
- Good Overall Stability
- Low Power Consumption
- Low HF Radiation
- ESD Protected On All Pins

Applications

- TVs and Monitors
- Portable Computers
- Desktop computers
- Low Voltage Audio Systems

Description

The FAN7040 is a mono Bridge-Tied Load(BTL) output amplifier with DC volume control. It is designed for use in TVs and monitors, but is also suitable for battery-fed portable recorders and radios. The device is contained in a 20-lead small outline package.

A Missing Current Limiter(MCL) is built in. the MCL circuit is activated when the difference in current between the output terminal of each amplifier exceeds 130mA. This level of 130mA allows for Single-Ended(SE) headphone applications.

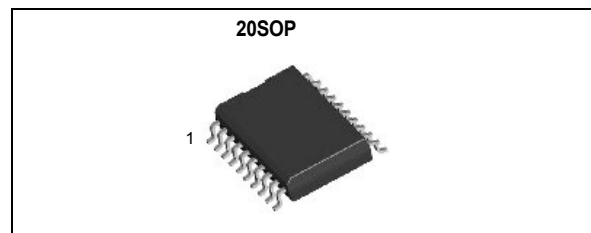

Internal Block Diagram

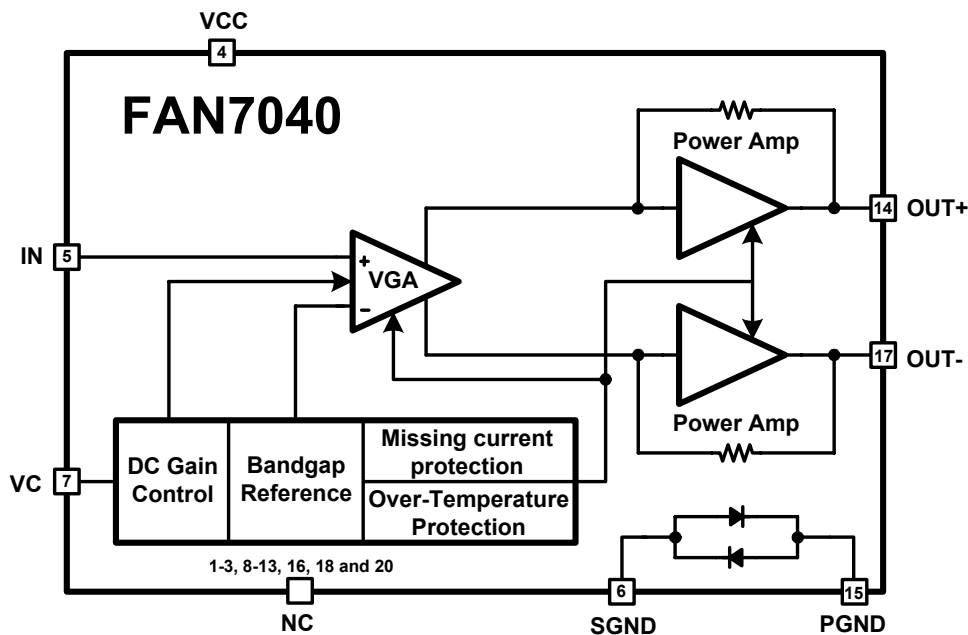

Rev. 1.1.0

Pin Assignments

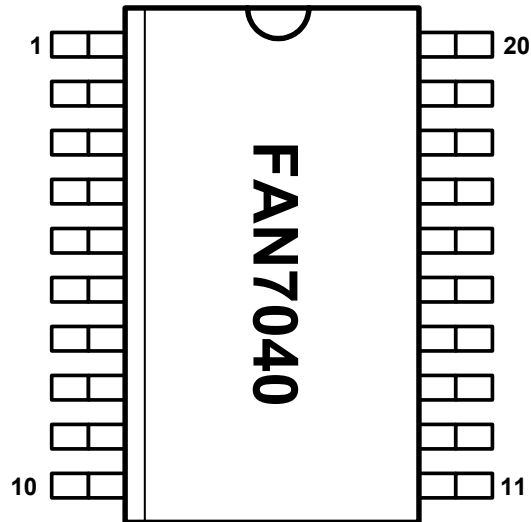

Pin Description

Pin No	Symbol	I/O	Description
1	N.C.		No Connection
2	N.C.		No Connection
3	N.C.		No Connection
4	VCC	I	Positive Power Supply
5	IN	I	Signal Input
6	SGND		Signal Ground
7	VC	I	DC Volume Control
8	N.C.		No Connection
9	N.C.		No Connection
10	N.C.		No Connection
11	N.C.		No Connection
12	N.C.		No Connection
13	N.C.		No Connection
14	OUT+	O	Positive Output
15	PGND		Power Ground
16	N.C.		No Connection
17	OUT-	O	Negative Output
18	N.C.		No Connection
19	N.C.		No Connection
20	N.C.		No Connection

Absolute Maximum Ratings

Parameter	Symbol	Value	Unit	Remark
Maximum Supply Voltage	VCCmax	18	V	
Maximum Input Voltage	VPIN5, VPIN7	5.0	V	
Repetitive Peak Output Current	IORM	1.25	A	
Non-repetitive Peak Output Current	IOSM	1.5	A	
Power Dissipation	PD	Internally Limited	W	
Storage Temperature	TSTG	-55 ~ +150	°C	
Junction Temperature	TJ	150	°C	
Thermal Resistance	Rthj-a	70	°C/W	

Operating Ratings

Parameter	Symbol	Min	Typ	Max	Unit
Power Supply Voltage	VCC	4.5	-	18	V
Operating Temperature	TOPG	-40	-	+85	°C

Electrical Characteristics

($V_{CC} = 12V$, $T_a = 25^\circ C$, $R_L = 16\Omega$, unless otherwise specified)

Parameter	Symbol	Conditions	Min.	Typ.	Max.	Unit
Supply Current	I_{CC}	$V_i = 0V$, No Load note1	-	5	10	mA
Maximum Gain(VC=2V) Note 2						
Output Power	P_O	THD+N =10%, $R_L = 16\Omega$	3	3.5	-	W
Total Harmonic Distortion	THD	$P_O = 0.5W$	-	0.3	1	%
Maximum Total Voltage Gain	$G_{V,max}$		34	37	-	dB
Input Signal Handling(RMS)	$V_{i,rms}$	$VC = 0.8V$, THD<1%	0.6	0.7	-	Vrms
Noise Output Voltage	$V_{n(o)}$	$f = 1kHz$, $R_s = 0\Omega$	-	15	-	μV
Power Supply Rejection Ratio	PSRR	Vripple=200mV, $R_s = 0\Omega$, $f = 1kHz$	30	-	-	dB
DC Output Offset Voltage	ΔV_{OS}	$ (OUT+) - (OUT-) $, $VC = 1.4V$	-	-	210	mV
Input Impedance(pin3)	Z_I		15	20	25	k Ω
Minimum Gain(VC=0.5V)						
Minimum Total Voltage Gain	$G_{V,min}$		-65	-52	-40	dB
Noise Output Voltage	$V_{n(o)}$	$f = 1kHz$, $R_s = 0\Omega$	-	1	-	μV
Mute Position						
Output Voltage in Mute Position	$V_{o,mute}$	$VC = 0.3V$, $V_i = 600mV_{rms}$, $f = 1kHz$	-	1	-	μV
DC Volume Control						
Voltage Gain Control Range	ΔG_V	$ G_{V,max} + G_{V,min} $	-	89	-	dB
Control Current	I_{VC}	$VC = 0V$	50	62	75	μA

Notes

1. With a load connected to the outputs, the quiescent current will increase as much as the DC output offset voltage divided by R_L .
2. The maximum gain of the amplifier is normally reached at $VC = 1.4V$ typical.

Performance Characteristics

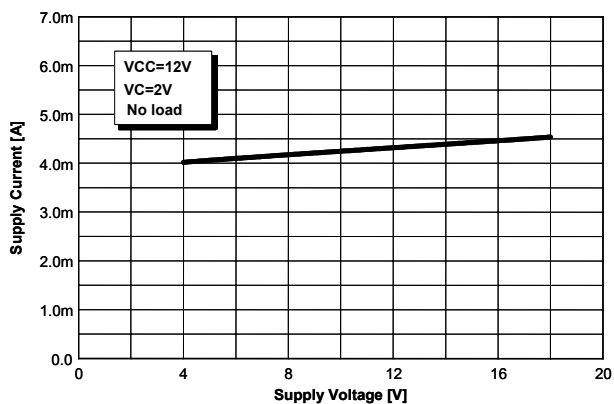

Fig. 1 Supply Current

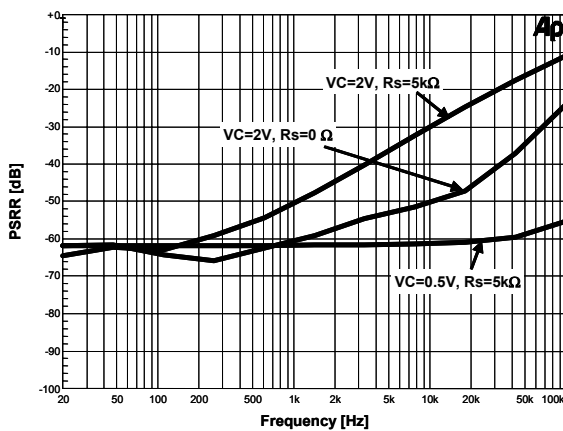

Fig. 2 Power Supply Rejection Ratio

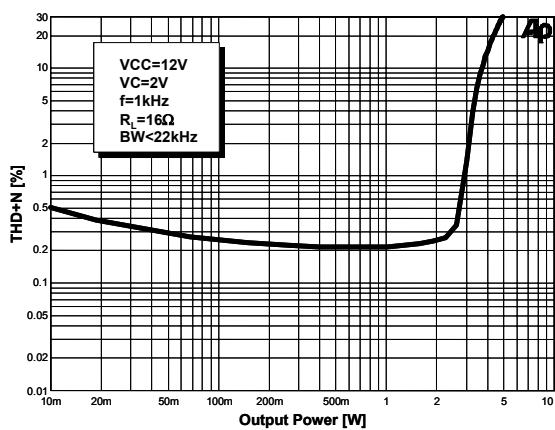

Fig. 3 THD+N vs. Output Power

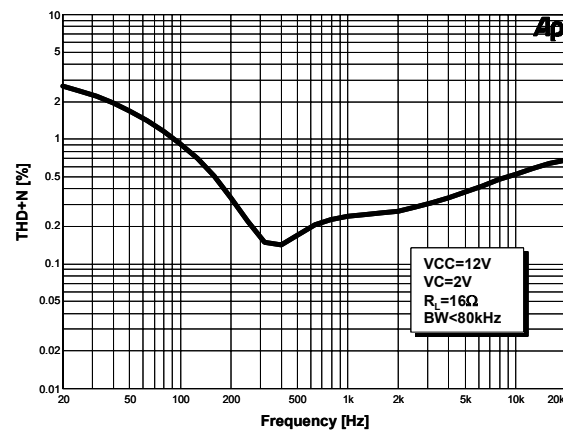

Fig. 4 THD+N vs. Frequency

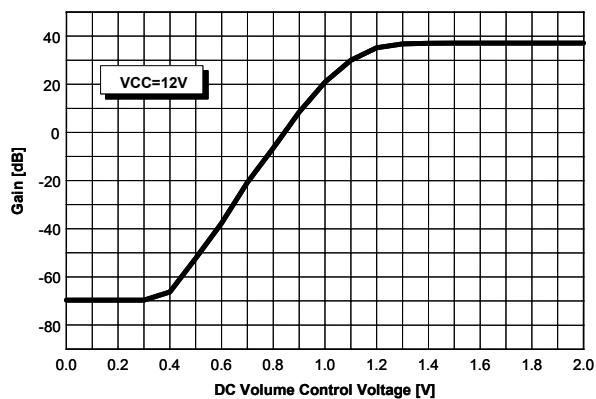

Fig. 5 Gain vs. DC Volume Control

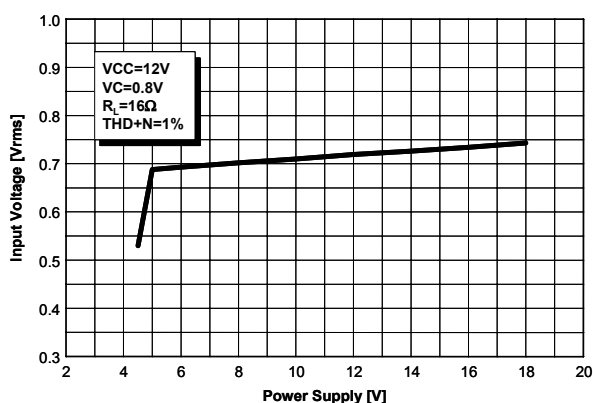

Fig. 6 Input Signal Handling

Performance Characteristics(continued)

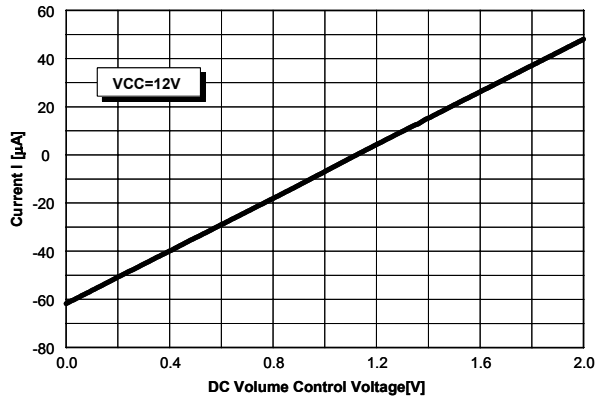

Fig. 7 Control Current vs. DC Volume Control

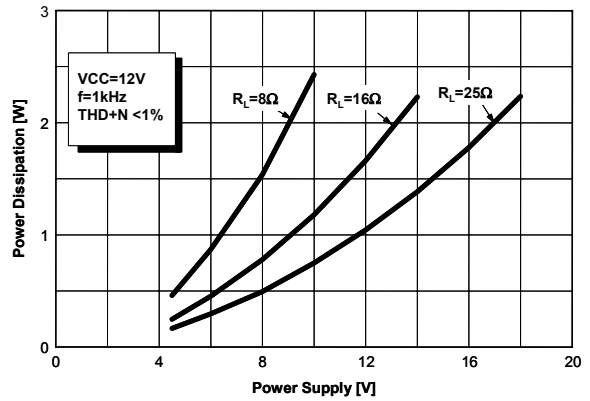

Fig. 8 Power Dissipation vs. Supply Voltage

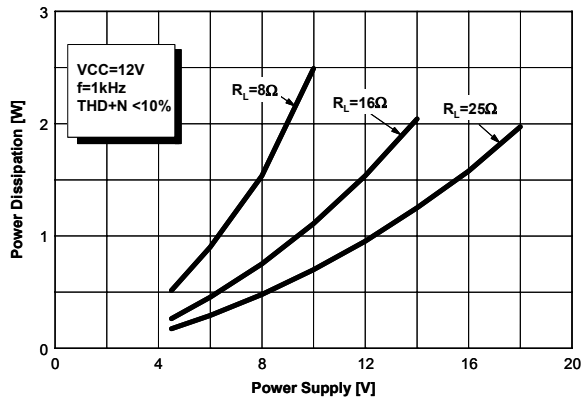

Fig. 9 Power Dissipation vs. Supply Voltage

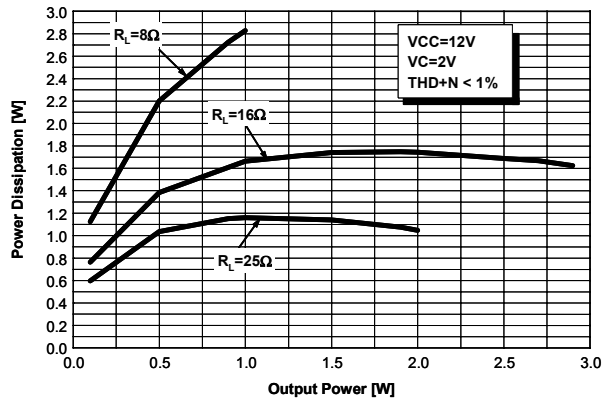

Fig. 10 Power Dissipation vs. Output Power

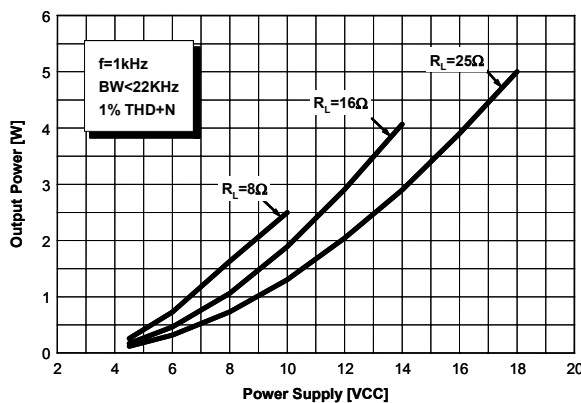

Fig. 11 Output Power vs. Supply Voltage

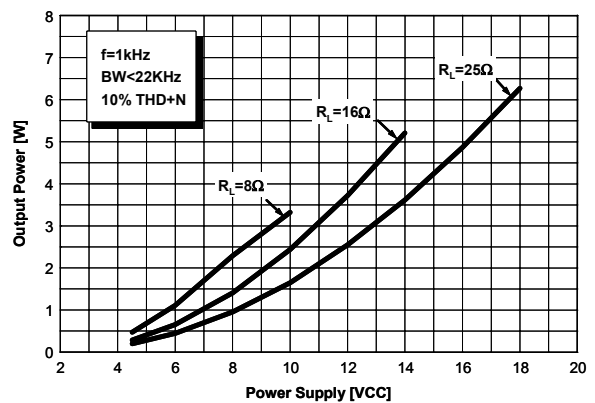

Fig. 12 Output Power vs. Supply Voltage

Performance Characteristics(continued)

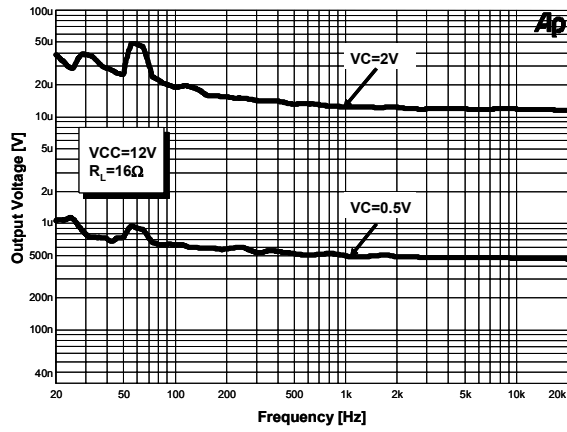

Fig. 15 Output Noise Voltage

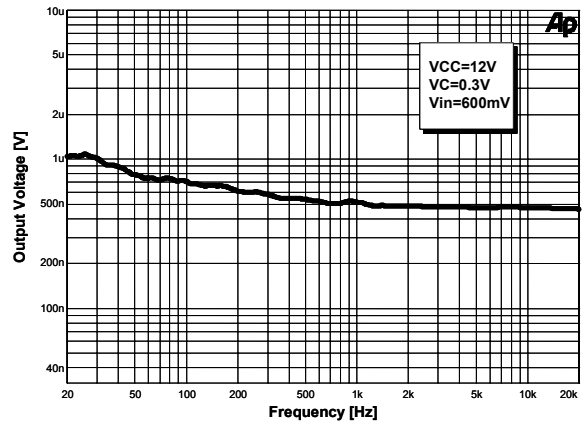

Fig. 14 Output Voltage in Mute State

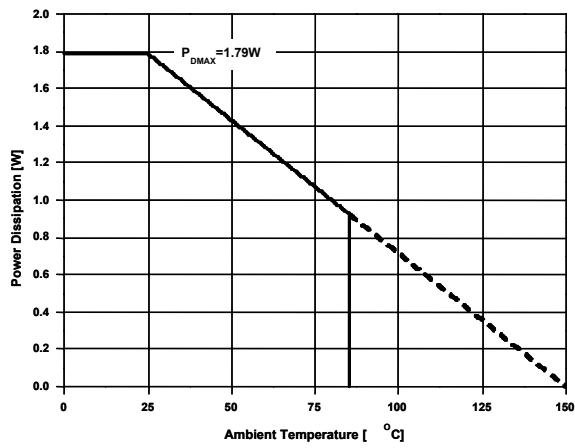
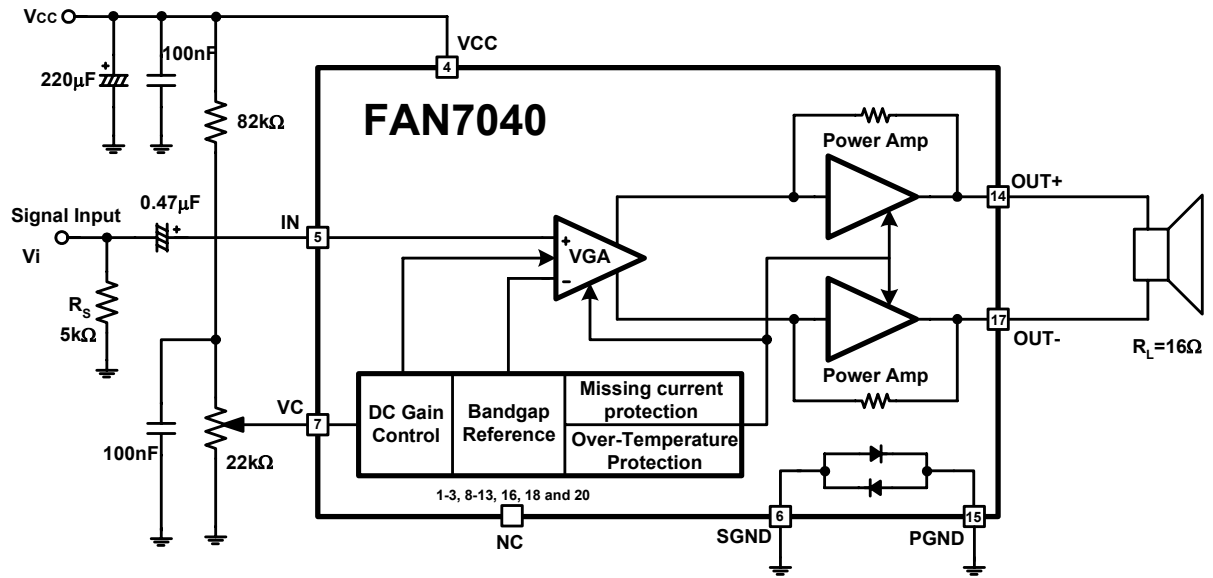

Fig. 15 Power Derating Curve

Typical Application Circuit



Typical Application Information

Functional Description

The FAN7040 is a mono BTL output amplifier with DC volume control. It is designed for use in TVs and monitors but is also suitable for battery-fed portable recorders and radios.

In conventional DC volume circuits the control or input stage is AC-coupled to the output stage via external capacitors to keep the offset voltage low. In the FAN7040 the DC volume control stage is integrated into the input stage so that no coupling capacitors are required. With this configuration, a low offset voltage is still maintained and the minimum supply voltage remains low.

The BTL principle offers the following advantages:

- Lower peak value of the supply current
- The frequency of the ripple on the supply voltage is twice the signal frequency.

Consequently, a reduced power supply with smaller capacitors can be used which also results in cost reductions. For portable applications there is a trend to decrease the supply voltage, resulting in a reduction of output power at conventional output stages. Using the BTL principle increases the output power. The maximum gain of the amplifier is fixed at 37dB. The DC volume control stage has a logarithmic control characteristic. The total gain can be controlled from 37dB to -52dB. If the DC volume control voltage is below 0.3V, the device switches to the mute mode. The amplifier is short-circuit proof to ground, Vcc and across the load. A thermal protection circuit is also implemented. If the crystal temperature rises above +150°C the TSD is operated, thereby the output power is off. Special attention is given to switch-on and switch-off clicks, low HF radiation and a good overall stability.

Voltage Gain

The maximum closed-loop voltage gain has been internally fixed at 37dB.

Output Power

The output power as a function of supply voltage has been measured at THD=10%. The maximum output power is limited by the maximum allowed power dissipation at Ta=25°C approximately 1.8W, and the maximum available output current is 1.25A repetitive peak current.

Short Circuit Protection

The output (pins 14 and 17) can be short-circuited to ground respectively to +VDD. The Missing Current Limiter(MCL) protection circuit will shut-off the amplifier. Removing the short-circuit will reset the amplifier automatically. Short-circuit across the load(pins 14 and 17) will activate the thermal protection circuit; this will result in thermal shutdown protection.

For single-end application the output peak current may not exceed 130mA; at higher output currents the short circuit protection(MCL) will be activated.

Power Dissipation

Power dissipation is a major concern when designing any power amplifier and must be thoroughly understood to ensure a successful design. Equation (1) states the maximum power dissipation point for a bridged amplifier operating at a given supply voltage and driving a specified output load.

$$P_{D\text{MAX}} = 4 \cdot \frac{V_{CC}^2}{2\pi^2 R_L} \quad (1)$$

Since the FAN7040 is driving a bridged amplifier, the internal maximum power dissipation point of the FAN7040 results from equation (1). Even with the large internal power dissipation, the FAN7040 does not require heat sinking over a wide range of ambient temperature. From equation (1), assuming a 12V power supply and a 16Ω load, the maximum power dissipation point is 1.8W. The maximum power dissipation point obtained from equation (1) must not be greater than the power dissipation that results from equation (2) :

$$P_{D\text{MAX}} = \frac{(T_{J\text{MAX}} - T_A)}{R_{thja}} \quad (2)$$

For package 20SOP, Rthja=70°C/W, TJMAX=150°C for the FAN7040.

Mechanical Dimensions

Package

Dimensions in millimeters/inches

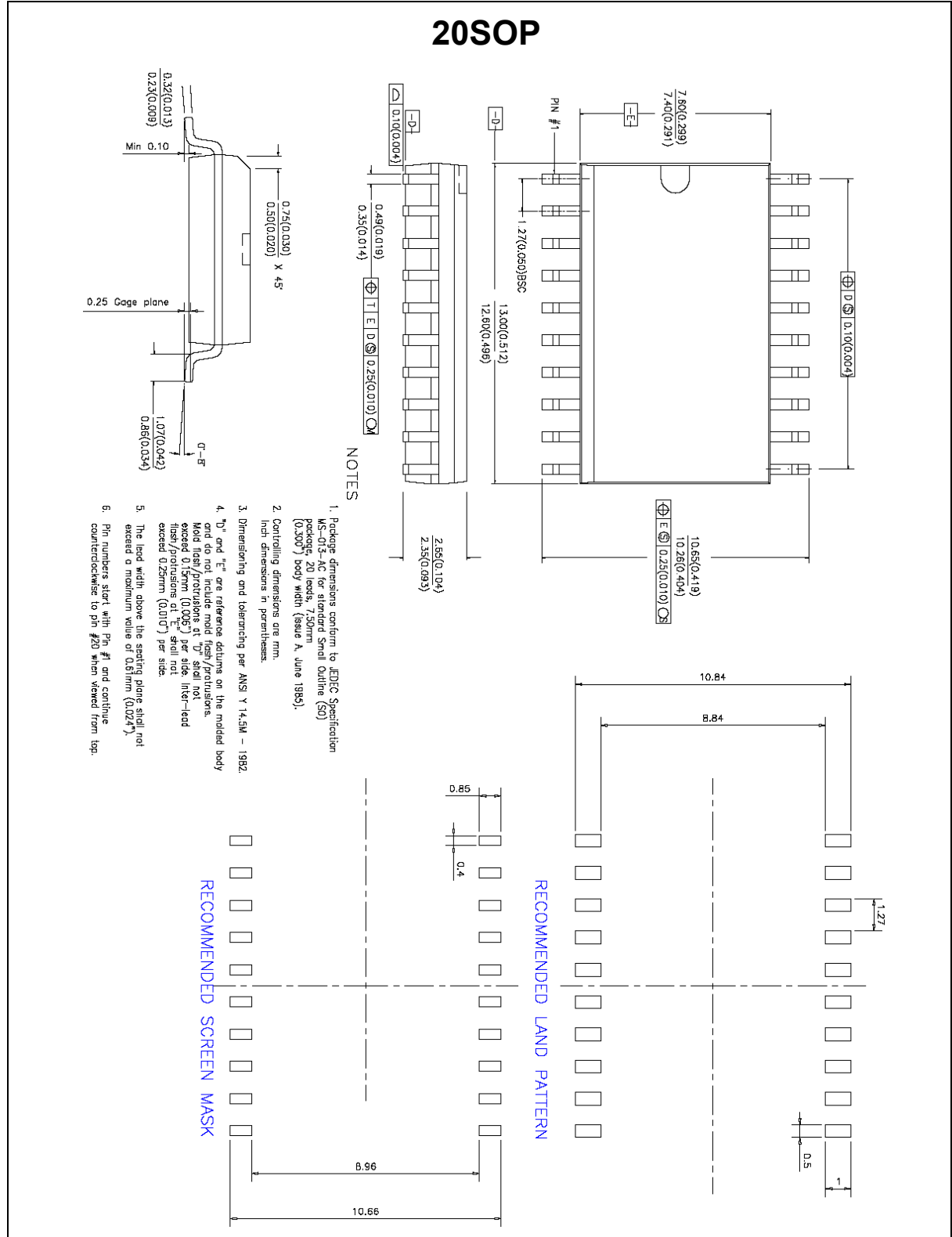

Ordering Information

Device	Package	Operating Temperature	Remarks
FAN7040M	20SOP	-40°C ~ +85°C	Tube
FAN7040MX			Tape & Reel

DISCLAIMER

FAIRCHILD SEMICONDUCTOR RESERVES THE RIGHT TO MAKE CHANGES WITHOUT FURTHER NOTICE TO ANY PRODUCTS HEREIN TO IMPROVE RELIABILITY, FUNCTION OR DESIGN. FAIRCHILD DOES NOT ASSUME ANY LIABILITY ARISING OUT OF THE APPLICATION OR USE OF ANY PRODUCT OR CIRCUIT DESCRIBED HEREIN; NEITHER DOES IT CONVEY ANY LICENSE UNDER ITS PATENT RIGHTS, NOR THE RIGHTS OF OTHERS.

LIFE SUPPORT POLICY

FAIRCHILD'S PRODUCTS ARE NOT AUTHORIZED FOR USE AS CRITICAL COMPONENTS IN LIFE SUPPORT DEVICES OR SYSTEMS WITHOUT THE EXPRESS WRITTEN APPROVAL OF THE PRESIDENT OF FAIRCHILD SEMICONDUCTOR CORPORATION. As used herein:

1. Life support devices or systems are devices or systems which, (a) are intended for surgical implant into the body, or (b) support or sustain life, and (c) whose failure to perform when properly used in accordance with instructions for use provided in the labeling, can be reasonably expected to result in a significant injury of the user.
2. A critical component in any component of a life support device or system whose failure to perform can be reasonably expected to cause the failure of the life support device or system, or to affect its safety or effectiveness.