



Chipsmall Limited consists of a professional team with an average of over 10 year of expertise in the distribution of electronic components. Based in Hongkong, we have already established firm and mutual-benefit business relationships with customers from,Europe,America and south Asia,supplying obsolete and hard-to-find components to meet their specific needs.

With the principle of “Quality Parts,Customers Priority,Honest Operation,and Considerate Service”,our business mainly focus on the distribution of electronic components. Line cards we deal with include Microchip,ALPS,ROHM,Xilinx,Pulse,ON,Everlight and Freescale. Main products comprise IC,Modules,Potentiometer,IC Socket,Relay,Connector.Our parts cover such applications as commercial,industrial, and automotives areas.

We are looking forward to setting up business relationship with you and hope to provide you with the best service and solution. Let us make a better world for our industry!



Contact us

Tel: +86-755-8981 8866 Fax: +86-755-8427 6832

Email & Skype: info@chipsmall.com Web: www.chipsmall.com

Address: A1208, Overseas Decoration Building, #122 Zhenhua RD., Futian, Shenzhen, China





Is Now Part of



ON Semiconductor®

To learn more about ON Semiconductor, please visit our website at
www.onsemi.com

ON Semiconductor and the ON Semiconductor logo are trademarks of Semiconductor Components Industries, LLC dba ON Semiconductor or its subsidiaries in the United States and/or other countries. ON Semiconductor owns the rights to a number of patents, trademarks, copyrights, trade secrets, and other intellectual property. A listing of ON Semiconductor's product/patent coverage may be accessed at www.onsemi.com/site/pdf/Patent-Marking.pdf. ON Semiconductor reserves the right to make changes without further notice to any products herein. ON Semiconductor makes no warranty, representation or guarantee regarding the suitability of its products for any particular purpose, nor does ON Semiconductor assume any liability arising out of the application or use of any product or circuit, and specifically disclaims any and all liability, including without limitation special, consequential or incidental damages. Buyer is responsible for its products and applications using ON Semiconductor products, including compliance with all laws, regulations and safety requirements or standards, regardless of any support or applications information provided by ON Semiconductor. "Typical" parameters which may be provided in ON Semiconductor data sheets and/or specifications can and do vary in different applications and actual performance may vary over time. All operating parameters, including "Typicals" must be validated for each customer application by customer's technical experts. ON Semiconductor does not convey any license under its patent rights nor the rights of others. ON Semiconductor products are not designed, intended, or authorized for use as a critical component in life support systems or any FDA Class 3 medical devices or medical devices with a same or similar classification in a foreign jurisdiction or any devices intended for implantation in the human body. Should Buyer purchase or use ON Semiconductor products for any such unintended or unauthorized application, Buyer shall indemnify and hold ON Semiconductor and its officers, employees, subsidiaries, affiliates, and distributors harmless against all claims, costs, damages, and expenses, and reasonable attorney fees arising out of, directly or indirectly, any claim of personal injury or death associated with such unintended or unauthorized use, even if such claim alleges that ON Semiconductor was negligent regarding the design or manufacture of the part. ON Semiconductor is an Equal Opportunity/Affirmative Action Employer. This literature is subject to all applicable copyright laws and is not for resale in any manner.



FAN8841

Dual Half-Bridge Piezoelectric Driver with Step-up DC-DC Converter

Features

Step-up DC-DC Converter

- Integrated Step-up Power Switch up to 36 V
- Wide Operating Voltage Range of 2.7 to 5.5 V
- Adjustable Step-up Output Voltage by V_{CON}
- Adjustable Step-up Switch Current Limit
- Zero Current Detector (ZCD)
- Internal Soft-Start
- Built-in Protection Circuit
 - Under-Voltage Protection (UVP)
 - Over-Voltage Protection (OVP)

Piezo Actuator Driver

- Integrated Half-Bridge Switches ($V_{DS}=75\text{ V}$)
- Dual Half-Bridge Piezoelectric Driver
- Built-in Shutdown Function

Package Information

- Small 4.0 mm × 4.0 mm MLP

Applications

- Piezoelectric Actuator

Description

The FAN8841 is a single-chip piezoelectric actuator driver consisting of a step-up DC-DC converter with integrated 36 V boost switch and the dual half-bridge output stages. The step-up DC-DC converter operates in Critical Conduction Mode (CRM) in order to reduce switching loss at the DC-DC converter for high efficiency. It is optimized to work in a coupled-inductor configuration to provide output voltages in excess of 60 V. The step-up DC-DC converter has a soft-start capability that limits the inrush current during startup. Over-voltage protection and over-current protection are included. Under-voltage protection is used to disable the dual half-bridge gate driver when the step-up DC-DC converter output voltage is lower than the specified threshold voltage. The boost voltage is set using external resistors and analog voltage at the V_{CON} pin and step-up current limit is programmable via the external resistor at the OCP pin. The output Half-bridge is integrated with 75 V P- and N-channel for the piezoelectric actuator driving. An open drain Fault-out (FO) signal indicates if an abnormal over-voltage has occurred.

Ordering Information

Part Number	Operating Temperature Range	Package	Packing Method
FAN8841MPX	-40°C to +125°C	24-Lead, 4.0 mm × 4.0 mm Molded Leadless Package (MLP)	Tape & Reel

Pin Configuration

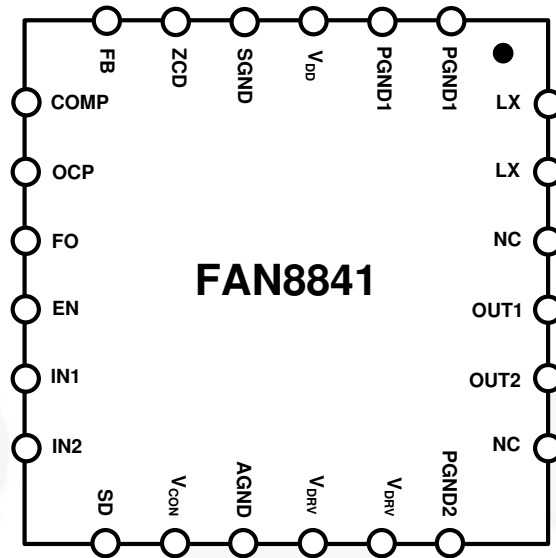

Figure 3. Pin Assignment

Pin Definitions

Pin #	Name	Description
1, 2	PGND1	Power Ground 1. It is connected to the source of the step-up switch.
3	V _{DD}	Power supply of step-up DC-DC converter.
4	SGND	Signal Ground. The signal ground for step-up DC-DC converter circuitry.
5	ZCD	The input of the Zero Current Detection
6	FB	Step-up DC-DC converter output voltage feedback input.
7	COMP	Output of the transconductance error amplifier.
8	OCP	Sets Step-up DC-DC converter current limit
9	FO	Fault Output.
10	EN	Enable pin to turn on and off the overall system. (Active Low Shutdown Mode).
11	IN1	Logic input for Half-Bridge 1
12	IN2	Logic input for Half-Bridge 2
13	SD	Shutdown input for H-Bridge 1 and 2. (Active Low Shutdown Mode).
14	V _{CON}	Control input for output voltage of step-up DC-DC converter
15	AGND	Analog Ground. The signal ground for H-bridge driver circuitry
16, 17	V _{DRV}	Power supply of each H-bridge driver
18	PGND2	Power Ground 2. The power ground for Half-bridge driver
19	NC	Not Connected
20	OUT2	Output for Half-bridge 2
21	OUT1	Output for Half-bridge 1
22	NC	Not Connected
23, 24	LX	Switch Node. This pin is connected to the inductor.

Absolute Maximum Ratings

Stresses exceeding the absolute maximum ratings may damage the device. The device may not function or be operable above the recommended operating conditions and stressing the parts to these levels is not recommended. In addition, extended exposure to stresses above the recommended operating conditions may affect device reliability. The absolute maximum ratings are stress ratings only.

Symbol	Parameter	Min.	Max.	Unit
V _{DRV}	DC Link Input Voltage Drain-Source Voltage of each MOSFET		75	V
V _{DD}	DC Supply Voltage for DC-DC Converter	-0.3	5.5	V
V _{INPUT}	EN, SD, IN1, IN2, FB and COMP to SGND and AGND	-0.3	V _{DD} +0.3	V
V _{CON}	V _{CON} to SGND	-0.3	V _{DD} +0.3	V
V _{LX}	LX to PGND	-0.3	40	V
P _D	Power Dissipation ⁽²⁾	1S0P with thermal vias ⁽³⁾	0.98	W
		1S2P with thermal vias ⁽⁴⁾	2.9	
θ _{JA}	Thermal Resistance Junction-Air ⁽¹⁾	1S0P with thermal vias ⁽³⁾	127	°C/W
		1S2P with thermal vias ⁽⁴⁾	43	
T _A	Operating Ambient Temperature Range	-40	125	°C
T _J	Operating Junction Temperature	-55	150	°C
T _{STG}	Storage Temperature Range	-55	150	°C
ESD	Electrostatic Discharge Capability	Human Body Model, JESD22-A114	2	KV
		Charged Device Model, JESD22-C101	500	V

Notes:

- All voltage values, except differential voltages, are given with respect to SGND, AGND and PGND pin.
- JEDEC standard: JESD51-2, JESD51-3. Mounted on 76.2 x 114.3 x 1.6 mm PCB (FR-4 glass epoxy material).
- 1S0P with thermal via: one signal layer with zero power plane and thermal via.
- 1S2P with thermal via: one signal layer with two power plane and thermal via.

Recommended Operating Conditions

The Recommended Operating Conditions table defines the conditions for actual device operation. Recommended operating conditions are specified to ensure optimal performance. Fairchild does not recommend exceeding them or designing to Absolute Maximum Ratings.

Symbol	Parameter	Min.	Max.	Unit
V _{DRV}	Supply Voltage for Half-Bridge Driver	13	60	V
V _{LX}	Boost Switch Voltage		36	V
V _{CON}	Output Voltage Control of DC-DC Converter	0.1	V _{DD}	V
V _{DD}	Operating Voltage for DC-DC Converter	2.8	5.0	V
R _{OCP}	Current Limit Control Resistor	3.3	150	kΩ

Electrical Characteristics

$V_{DD}=3.0\text{ V}$, $V_{DRV}=60\text{ V}$, and $T_A=-40^\circ\text{C}$ to $+125^\circ\text{C}$. Typical values $T_A=25^\circ\text{C}$, unless otherwise specified.

Symbol	Parameter	Conditions	Min.	Typ.	Max.	Unit
Power Supply Section						
$I_{Q,DD}$	Quiescent Current for V_{DD} ⁽⁵⁾	$V_{EN}=V_{COMP}=V_{DD}$,		800	1200	μA
$I_{Q,DRV}$	Quiescent Current for V_{DRV}	$V_{FB}=1.0\text{ V}$, $V_{IN1}=V_{IN2}=0\text{ V}$		400	800	μA
$I_{SD,DD}$	Shutdown Current for V_{DD}	$V_{EN}=0\text{ V}$,			1	μA
$I_{SD,DRV}$	Shutdown Current for V_{DRV}	$V_{DD}=V_{DRV}=3\text{ V}$		8	15	μA
$V_{DDSTART}$	Start Threshold Voltage		2.6	2.7	2.8	V
$V_{DDUVHYS}$	V_{DD} UVLO Hysteresis Voltage		0.10	0.2		V
Error Amplifier Section						
V_{FB}	Feedback Reference Voltage	$T_A=25^\circ\text{C}$	0.99	1.00	1.01	V
I_{FB}	FB pin Bias Current	$V_{FB}=0\text{ V} \sim 2\text{ V}$			1	μA
ΔV_{FB1}	Feedback Voltage Line Regulation ⁽⁶⁾	$2.7\text{ V} < V_{DD} < 5\text{ V}$,		0.5	1.5	%/V
G_m	Transconductance	$T_A=25^\circ\text{C}$		800		μmho
Zero Current Detect Section						
V_{ZCD}	Input Voltage Threshold ⁽⁷⁾		1.65	1.83	2.00	V
V_{CLAMPH}	Input High Clamp Voltage	$I_{DET}=2.3\text{ mA}$	3.0	3.5	4.0	V
V_{CLAMPL}	Input Low Clamp Voltage	$I_{DET}=-2.3\text{ mA}$	-0.30	0.12	0.50	V
$I_{ZCD,SR}$	Source Current Capability				-2.3	mA
$I_{ZCD,SK}$	Sink Current Capability				2.3	mA
$t_{ZCD,D}$	Delay From ZCD to Output Turn-On ⁽⁷⁾			50	200	ns
Maximum On-Time Section						
$t_{ON,MAX}$	Maximum On-Time		15	25	35	μs
Soft-Start Timer Section						
t_{SS}	Internal Soft-Start		16	28	40	ms
Restart / Maximum Switching Frequency Limit Section						
t_{RST}	Restart Timer		15	25	35	μs
f_{MAX}	Maximum Switching Frequency ⁽⁷⁾			900	1000	KHz

Notes:

- This is only the V_{DD} current consumption with no switching condition. It does not include gate-drive current.
- The line regulation is calculated based on $\frac{\Delta V_{OUT}}{\Delta V_{IN}} \times \frac{1}{V_{OUT}}$.
- This parameter, although guaranteed by design, is not tested in production.

Electrical Characteristics

$V_{DD}=3.0\text{ V}$, $V_{DRV}=60\text{ V}$, and $T_A=-40^\circ\text{C}$ to $+125^\circ\text{C}$. Typical values $T_A=25^\circ\text{C}$, unless otherwise specified.

Symbol	Parameter	Conditions	Min.	Typ.	Max.	Unit
Current Limit Comparator Section						
I _{OCP}	OCP Trip Current	R _{OCP} =3.3 K Ω , V _{DD} =3.3 V	1.85	2.00	2.15	A
		R _{OCP} =22 K Ω , V _{DD} =3.3 V	0.9	1.0	1.1	A
t _{CS_BLANK}	Comparator Leading-Edge Blanking Time ⁽⁸⁾		80	130	180	ns
Step-up Output Control Section						
I _{CON}	Internal Current Source for V _{CON} Pin	T _A =25 $^\circ\text{C}$	9.0	10	11	μA
V _{CON+}	Positive Going Threshold Voltage ⁽⁸⁾			1.0		V
V _{CON-}	Negative Going Threshold Voltage ⁽⁸⁾			0.1		V
Step-up Switch Section						
R _{DSON}	N-Channel On Resistance	V _{DD} =3.3 V, T _A =25 $^\circ\text{C}$		0.2	0.5	Ω
I _{LK_LX}	LX Leakage Current	V _{LX} =36 V			1.0	μA
Logic (EN, IN1, IN2, SD) Section						
V _{INPUT+}	Input Logic High Threshold Voltage		1.34			V
V _{INPUT-}	Input Logic Low Threshold Voltage				0.5	V
I _{INPUT-}	Input Low Current	V _{EN} =0 V			1	μA
I _{INPUT+}	Input High Current	V _{EN} =V _{DD}	16	24	32	μA
R _{INPUT}	Input Logic Pull-Down Resistance	V _{EN} =V _{INPUT} =3 V		125		K Ω
Full-Bridge Switch Section						
R _{DS,ONP}	Output Upper-Side On Resistance	T _A =25 $^\circ\text{C}$		3.0	5.0	Ω
R _{DS,ONN}	Output Low-Side On Resistance			3.0	5.0	Ω
t _{ON}	Turn-on Propagation Delay Time	V _{DRV} =30 V, T _A =25 $^\circ\text{C}$		300		ns
t _{OFF}	Turn-off Propagation Delay Time			330		ns
Protection (UVP, and OVP)						
V _{UVP}	Under-Voltage Threshold of DC-DC Con.		11	12	13	V
HY _{UVP}	Under-Voltage Hysteresis			1.0		V
V _{OVP}	OVP Threshold Voltage		1.05	1.10	1.15	V
HY _{OVP}	OVP Hysteresis Voltage			0.1		V
t _{FO}	Fault Output Duration				20	30
V _{FOL}	Fault Output Low Level voltage	R _{PU} =50 K Ω , V _{PU} =3 V		0.1	0.4	V

Note:

8. This parameter, although guaranteed by design, is not tested in production.

Design Consideration Information

Figure 4 shows the timing chart for overall system.

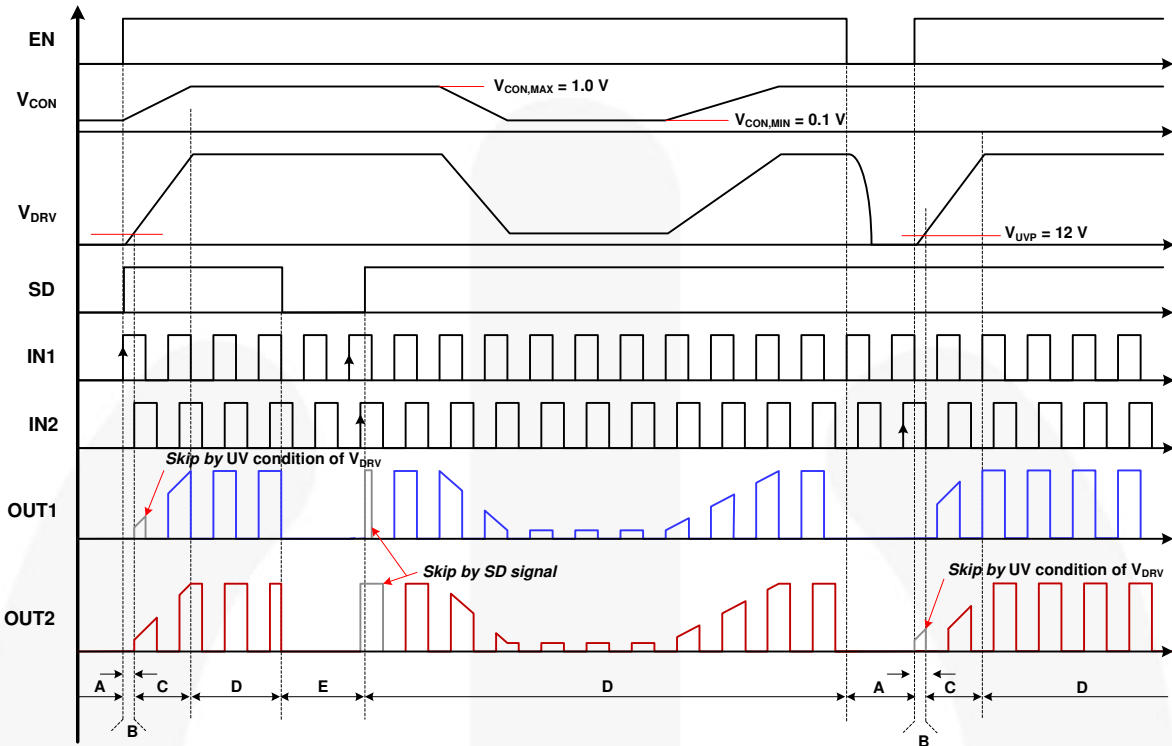

Figure 4. Timing Chart of Overall System

Table 1. Operating Modes

Input				Output		Mode		
IN1	IN2	EN	SD	OUT1	OUT2	State	DC-DC	H-Bridge
X	X	L	X	L	L	A	Whole System Disable	
X	X	H	L	L	L	E	Active	Disable
L	L	H	H	L	L	D	Normal Operation	
L	H			L	H			
H	L			H	L			
H	H			H	H			

Notes:

9. X: Don't care (L or H).
10. EN: Whole system is disable mode when EN is LOW state.
11. Soft-start duration: C, under-voltage condition of V_{DRV} : B.

Typical Performance Characteristics

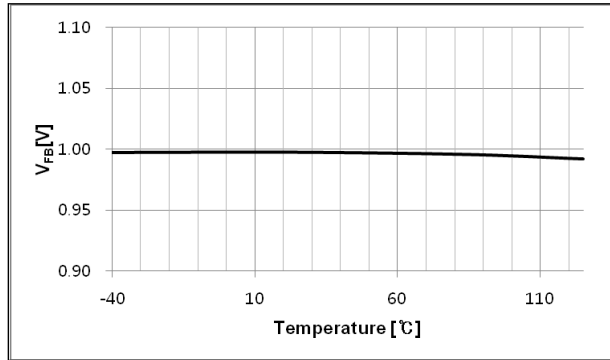

Figure 5. Reference Voltage vs. Temperature

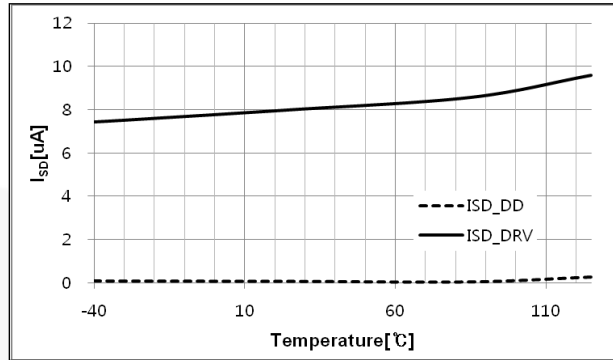

Figure 6. Shutdown Current for V_{DD} & V_{DRV} vs. Temperature

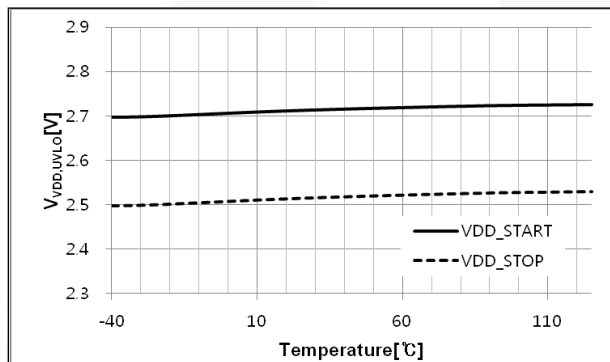

Figure 7. V_{DD} Threshold vs. Temperature

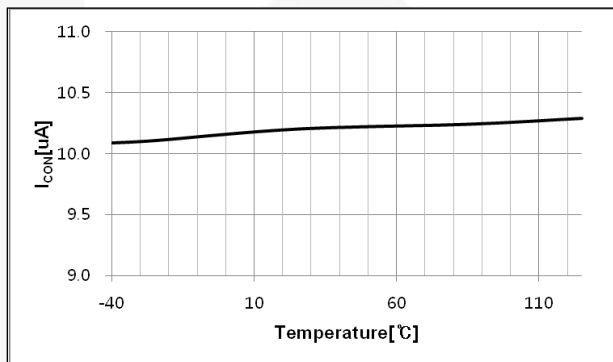

Figure 8. V_{CON} Current vs. Temperature

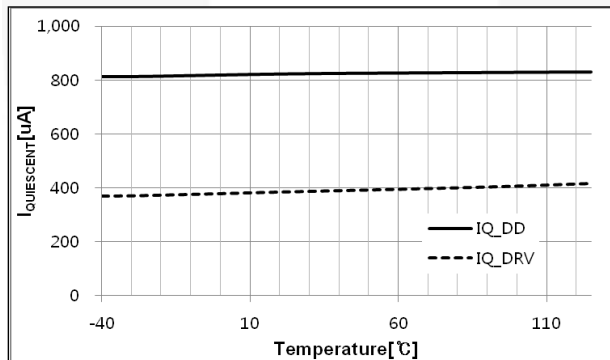

Figure 9. Quiescent Current for V_{DD} & V_{DRV} vs. Temperature

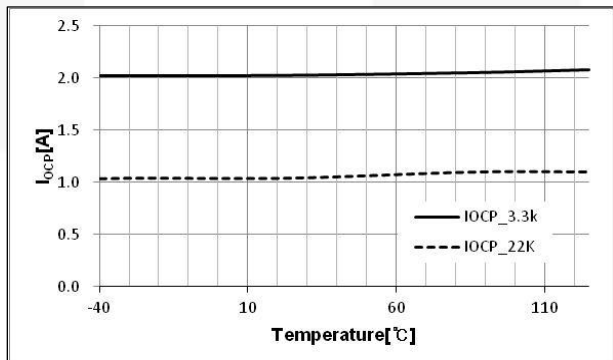

Figure 10. OCP Current vs. Temperature

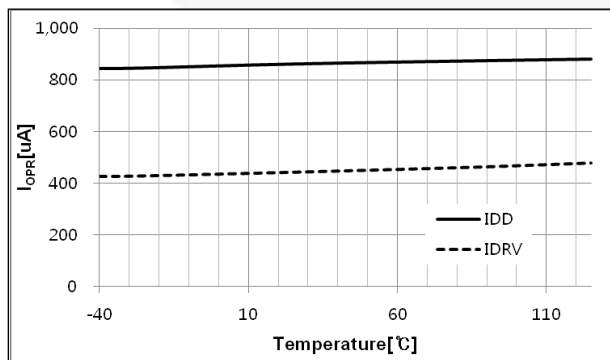

Figure 11. Operating Current for V_{DD} , V_{DRV} , & V_{IN}

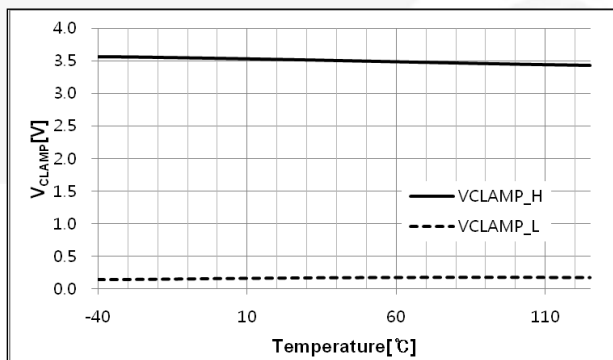

Figure 12. ZDC Clamp Voltage vs. Temperature

vs. Temperature

Typical Performance Characteristics (Continued)

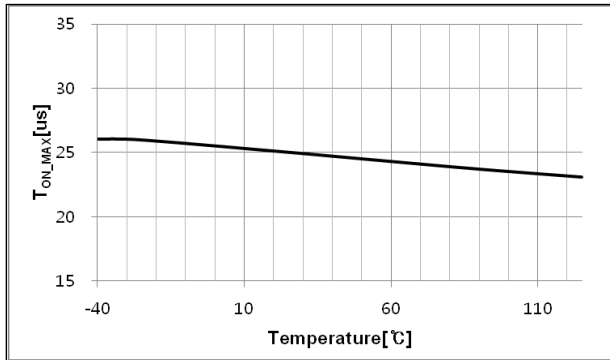

Figure 13. Maximum On-Time vs. Temperature

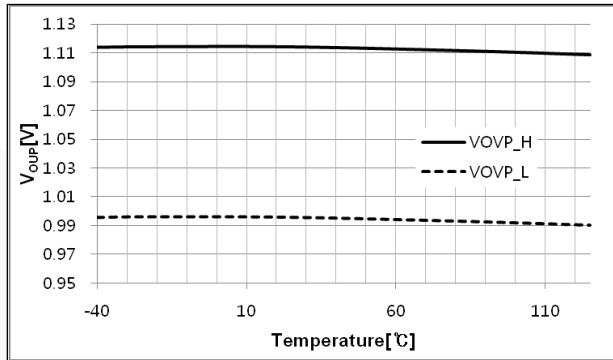

Figure 14. OVP (FB) vs. Temperature

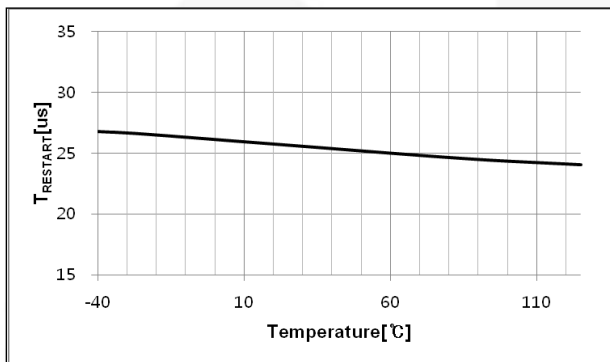

Figure 15. Restart-Time vs. Temperature

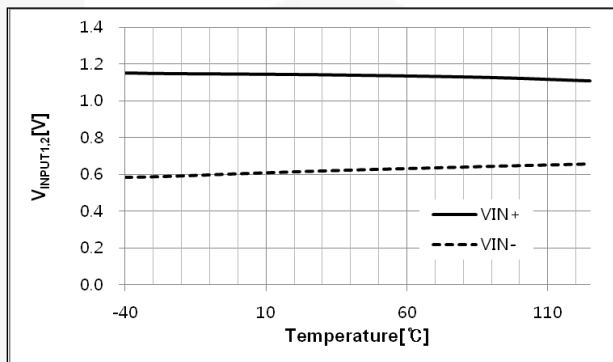

Figure 16. INPUT Threshold vs. Temperature

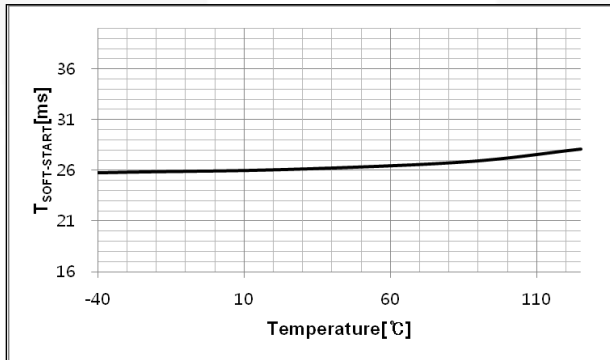

Figure 17. Soft-Start Time vs. Temperature

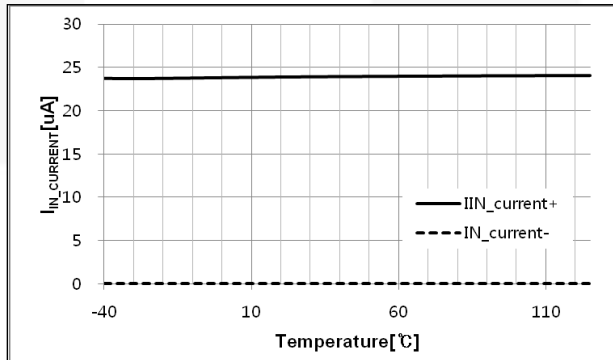

Figure 18. INPUT Logic Current vs. Temperature

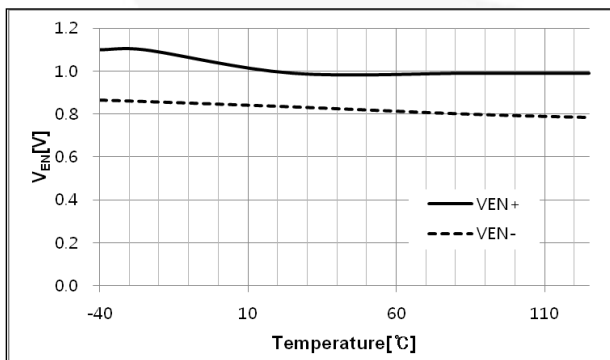

Figure 19. Enable(EN) Threshold Voltage vs. Temperature

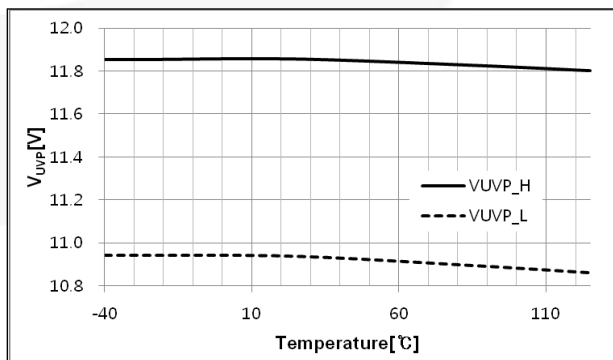

Figure 20. V_DRV UVP Threshold Voltage vs. Temperature

Typical Performance Characteristics (Continued)

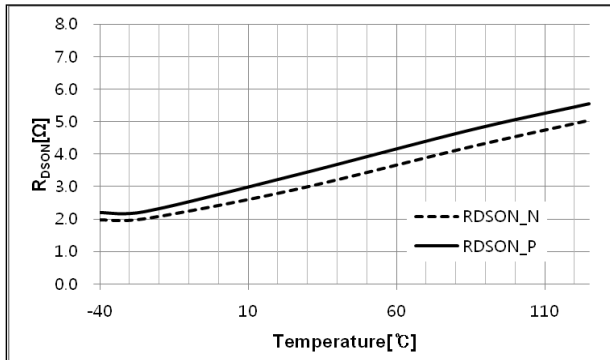

Figure 21. Half-Bridge Switch $R_{DS(on)}$ vs. Temperature

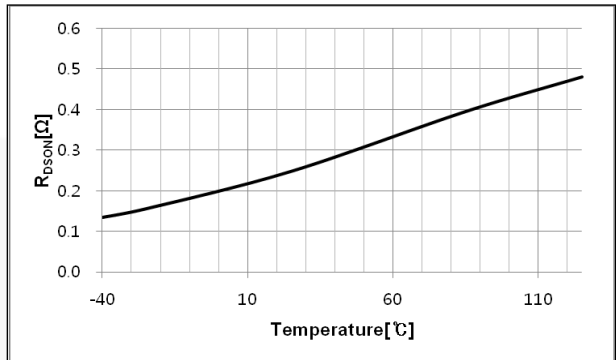

Figure 22. Boost Switch $R_{DS(on)}$ vs. Temperature

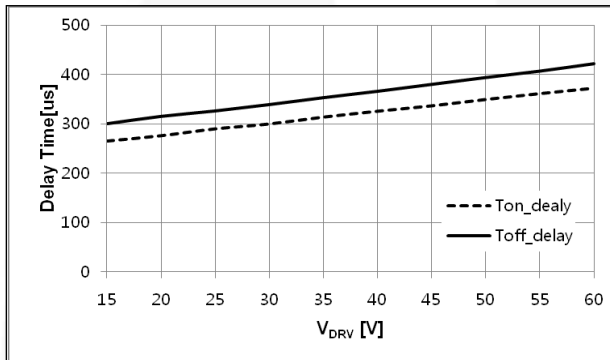

Figure 23. OUT1/2 Delay vs. V_{DRV}

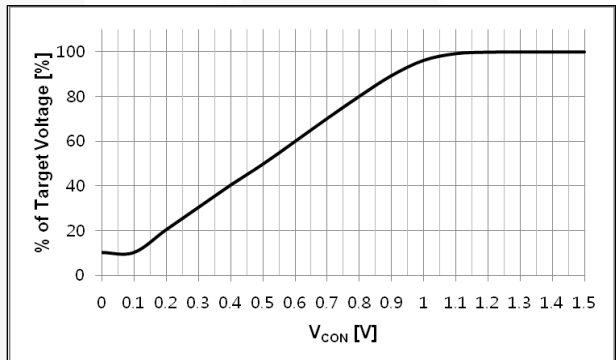

Figure 24. % of OUT Amplitude vs. V_{CON}

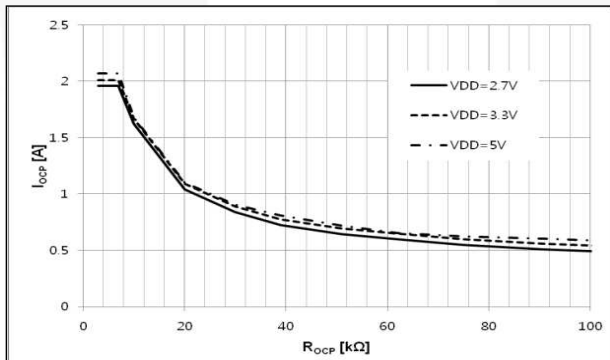

Figure 25. I_{OCP} vs. R_{OCP}

Functional Description

The FAN8841 has a basic PWM controller for Step-up DC-DC converter topology in Critical Conduction Mode (CRM) and integrated Dual half-bridge drivers. To increase efficiency of the DC-DC converter, FAN8841 has a Zero Current Detection (ZCD) function for CRM control. It can reduce Step-up DC-DC converter switching loss at MOSFET turn on time. The FAN8841 Step-up DC-DC converter supports output voltage up to 36 V with the use of a commercial inductor since the absolute maximum voltage of internal switching FET V_{DS} is 40 V. If the use requires a driving voltage higher than 36 V, it is recommended to use a coupled inductor, since the internal half-bridge absolute maximum voltage is 75 V.

The device architecture is that of a current mode controller with an internal sensing resistor connected in series with the NMOS switch. The voltage at the feedback pin tracks the output voltage at the cathode of the external Schottky diode. The internal error amplifier amplifies the difference between the feedback voltage and the internal reference voltage. Its error signal is applied to the input of a compensator and is compared to the current of the main switch which produces the appropriate duty cycle of the main switch in the inner loop. The amplified error voltage serves as a reference voltage to the internal PWM comparator. The PWM comparator resets the latch when the RAMP generator signal meets the error amp output level. The ZCD signal sets the latch and the SR latch turns on the FET switch. Since the comparator input contains information about the output voltage and the control loop is arranged to form a negative feedback loop, the value of the peak inductor current is adjusted to the driving power.

Every time the latch is reset, the FET is turned off and the current flow through the switch is terminated. The latch can be reset by other events as well. Over-current condition is monitored by the current limit comparator which resets the latch and turns off the switch instantaneously within each clock cycle.

Soft Startup

The FAN8841 has a Soft Startup function to prevent inrush current during the Step-up DC-DC converter startup. When the EN pin voltage goes HIGH from LOW, the Step-up DC-DC converter is turned on, the COMP is pre-charged, and inverting input of the internal error amplifier reference voltage starts up gradually with regular slope. This time is typically 28 ms at the maximum V_{CON} .

Adjustable V_{DRV} Voltage (V_{CON} Control)

The FAN8841 can control the Step-up DC-DC converter output voltage without changing the resistive feedback divider using the V_{CON} pin. The V_{CON} is controlled directly by the external DC voltage or external resistance value. V_{CON} control range is fixed from 0.1 to 1.0 V. If V_{CON} voltage decreases below 0.1 V or increases higher than 1.0 V, V_{DRV} voltage fixed on minimum or maximum voltage due to the internal clamp level. If the user wants a fixed V_{DRV} voltage, it is

recommended that the V_{CON} pin is connected with V_{DD} voltage.

Zero Current Detection (ZCD)

The Step-up DC-DC converter of the FAN8841 operates in CRM method with ZCD function. The ZCD is detected instantly when the inductor current goes to zero voltage switching operation. Once the boost inductor current becomes zero, the output capacitor of the main FET (C_{OSS}) and the magnetizing inductor of the coupled inductor (L1) resonate together, and the drain voltage of the main switch decreases, as shown in Figure 26. Since the ZCD pin can be connected to the switching diode anode, the FAN8841 detects when the diode anode voltage reaches its minimum value directly. The threshold voltage to detect the anode voltage inside the ZCD pin is typically 1.83 V. Therefore, the next switching begins after the anode voltage reaches 1.83 V, and has a 200 ns maximum delay to the next gate turn-on.

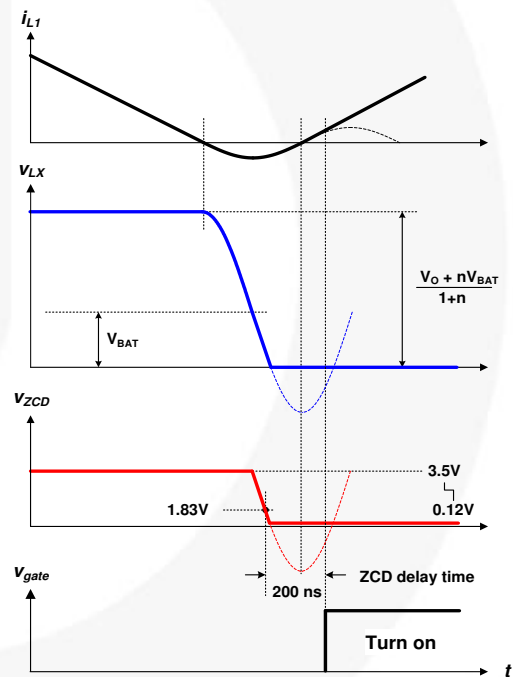

Figure 26. Waveforms for ZCD

The resistor R_{ZCD} is obtained as follows:

$$R_{ZCD} \geq \frac{(V_{DRV} + 0.7) - V_{CLAMP}}{I_{ZCD}} \quad (1)$$

Over-Current Protection (OCP)

The Over-Current Protection (OCP) function of the FAN8841 limits the inductor peak current of the Step-up DC-DC converter via an external resistor R_{OCP} . The adjustable current limit should be less than the rated saturation limit of the inductor by the user to avoid the damage to both the inductor and FAN8841.

V_{DRV} Under-Voltage Protection

The driving voltage of the internal dual Half-bridge is received from the V_{DRV} pin. The internal 5 V LDO for driving the internal gate driver is also received from the V_{DRV} pin. For supplying a stable power to the internal gate driver, V_{DRV} has an under-voltage protection function. If the V_{DRV} voltage is less than 11 V typically, during normal operation, the internal gate driver is turned off. When the V_{DRV} voltage exceeds 12 V typically, the internal gate driver is turned on.

Over-Voltage Protection (OVP)

The FAN8841 features a unique V_{DRV} monitoring to maximize the safety when the feedback voltage is higher than the specified threshold voltage. The OVP comparator shuts down the output drive block when the voltage of the FB pin is higher than 1.1 V.

At the normal operating condition, Fault Out signal maintains on V_{DD} voltage, but the abnormal over-voltage has occurred at V_{DRV}, Fault Out signal goes low during typ. 20 μs.

Application information

Setting the Output Voltage

The internal reference is 1.0 V (Typical) and it controlled by the V_{CON} voltage. The output voltage is divided by the external resistor divider, R_{FB1} and R_{FB2} to the FB pin. The output voltage is given by:

$$V_{DRV} = V_{REF} \left(1 + \frac{R_{FB1}}{R_{FB2}} \right) \quad (2)$$

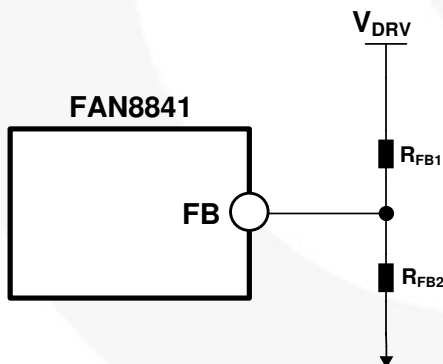

Figure 27. Feedback Circuit

Inductor Selection

To prevent the absolute maximum voltage in the operating condition, the switching voltage V_{LX} should be lower than 36 V, as shown in Figure 28.

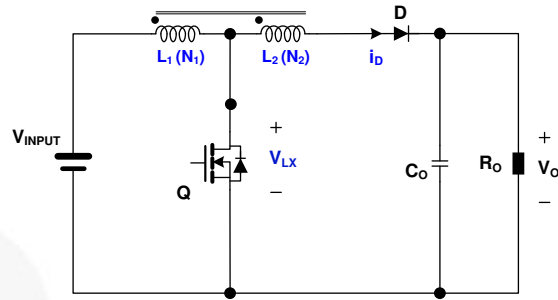

Figure 28. Schematic of Coupled Inductor Boost Converter

V_{LX} is determined by the output voltage, input voltage and coupled inductor turn ratio. The V_{LX} voltage is calculated as follows:

$$V_{LX} = V_{INPUT} + \frac{V_o - V_{INPUT}}{n + 1} = \frac{V_o + nV_{INPUT}}{n + 1} \quad (3)$$

Therefore, the turn's ratio can be easily obtained as the following equations:

$$n = \frac{V_o - V_{LX}}{V_{LX} - V_{INPUT}} \quad (4)$$

To determine the turn's ratio, the input voltage variation has to be considered as well.

The inductor parameters are directly related to the device performance, saturation current and DC resistance. The lower the DC resistance, the higher efficiency. Usually a trade-off between inductor size, cost and overall efficiency is needed to make the optimum choice.

The inductor saturation current should be rated around 2 A at maximum power in the FAN8841. If to use a low saturation current inductor under 2 A due to inductor size, it is possible using the OCP level control.

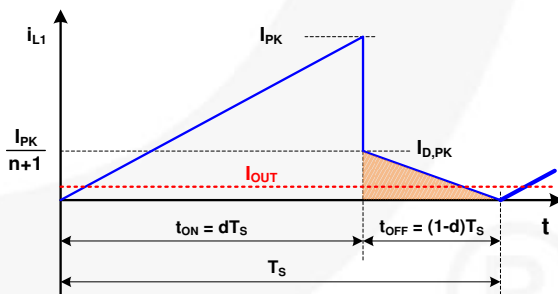

Figure 29. Current Waveform

In CRM operation, the inductance can be obtained from the slope of the inductor current, as shown in Figure 29. During FET turn off period, the inductor current flows through the diode. The diode peak current is expressed as follows:

$$I_{D,PK} = \frac{2I_{OUT}}{1 - d} \quad (5)$$

And then, the peak current of the main switch is obtained as follows:

$$I_{PK} = \frac{2I_{OUT}(1+n)}{1-d}, \text{ or } I_{PK} = \frac{V_{INPUT}}{L_1} dT_s \quad (6)$$

The inductance value obtained as follows:

$$L_1 = \frac{V_{INPUT} dT_s}{I_{PK}} = \frac{V_{INPUT} d(1-d)T_s}{2I_{OUT}(1+n)} \quad (7)$$

If a user wants a commercial inductor at output voltage under 35 V condition, n(turns ratio at using coupled inductor) should be substituted the value zero, (turns ratio at using coupled inductor).

Output Capacitor Selection

The value of the output capacitor can be selected based on the output voltage ripple requirements. Without consideration of the effect of Equivalent Series Resistance (ESR) as output capacitors, the output voltage ripple in a peak-to-peak manner is obtained as follows:

$$V_{ripple,pp} = \frac{\left(2d + \frac{(1-d)^2}{2}\right) \cdot I_{OUT} \cdot T_s}{2C_o} \quad (8)$$

where $V_{ripple,pp}$ is the output voltage ripple in peak-to-peak manner. Therefore, the output capacitance can be selected with the given output voltages ripple specification as follows:

$$C_o \geq \frac{\left(2d + \frac{(1-d)^2}{2}\right) \cdot I_{OUT} \cdot T_s}{2V_{ripple,pp}} \quad (9)$$

Diode Selection

The external diode used for the rectification is usually a Schottky diode. It's average forward current and reverse voltage maximum ratings should exceed the load current and the voltage at the output of the converter respectively.

A care should be taken to avoid any short circuit of V_{OUT} to GND, even with the IC disabled, since the diode can be instantly damaged by the excessive current.

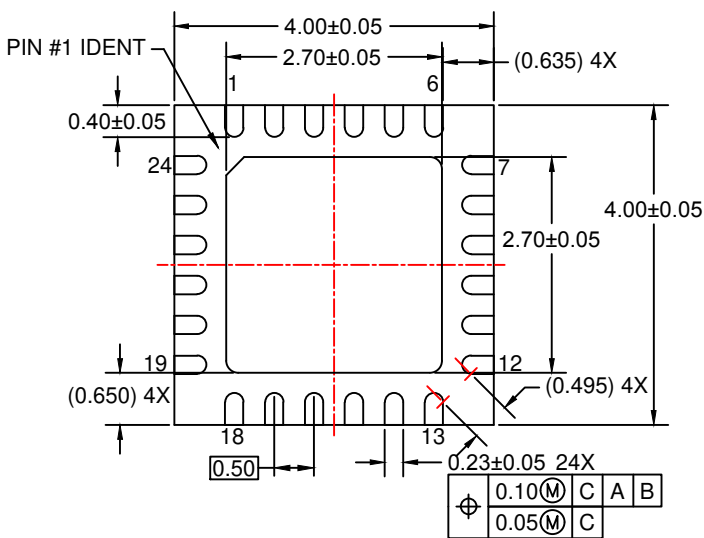
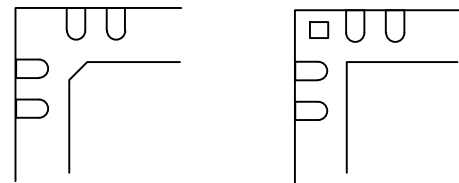
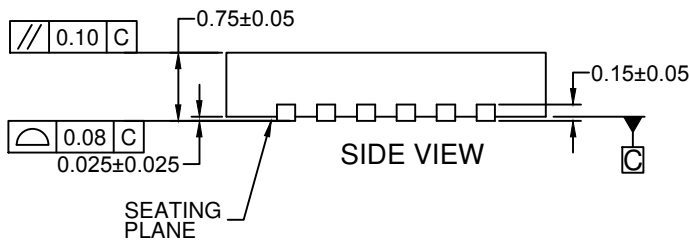
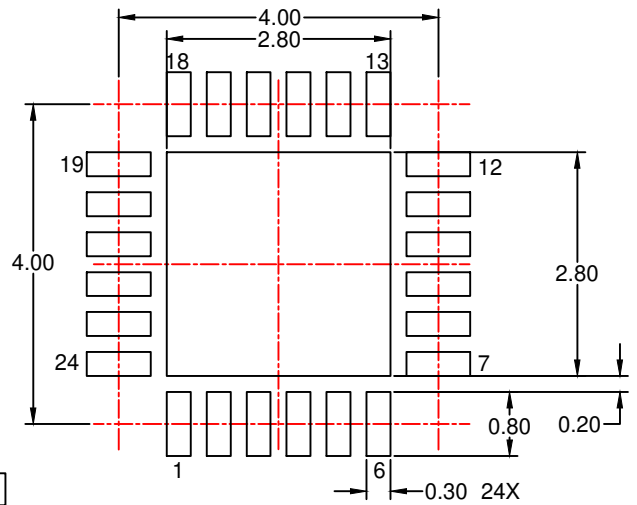
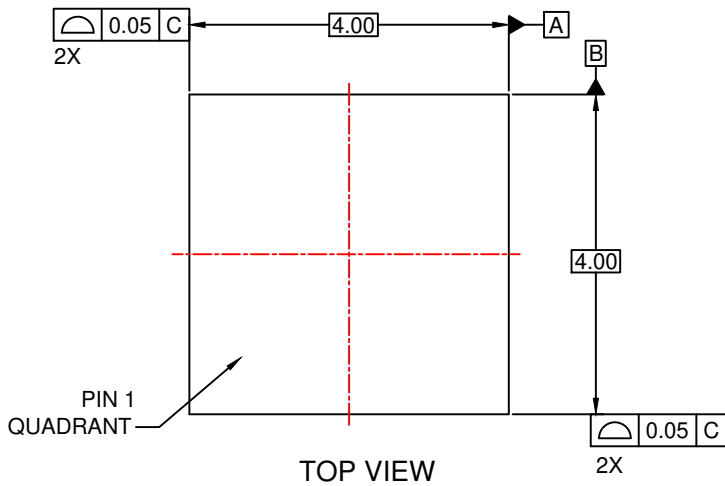

NOTES:

- A. CONFORMS TO JEDEC REGISTRATION MO-220, VARIATION WGGD-6.
- B. DIMENSIONS ARE IN MILLIMETERS.
- C. DIMENSIONS AND TOLERANCES PER ASME Y14.5M, 2009.
- D. LAND PATTERN IPC REFERENCE : QFN50P400X400X80-25W6N.
- E. DRAWING FILENAME: MKT-MLP24Erev5.



ON Semiconductor and  are trademarks of Semiconductor Components Industries, LLC dba ON Semiconductor or its subsidiaries in the United States and/or other countries. ON Semiconductor owns the rights to a number of patents, trademarks, copyrights, trade secrets, and other intellectual property. A listing of ON Semiconductor's product/patent coverage may be accessed at www.onsemi.com/site/pdf/Patent-Marking.pdf. ON Semiconductor reserves the right to make changes without further notice to any products herein. ON Semiconductor makes no warranty, representation or guarantee regarding the suitability of its products for any particular purpose, nor does ON Semiconductor assume any liability arising out of the application or use of any product or circuit, and specifically disclaims any and all liability, including without limitation special, consequential or incidental damages. Buyer is responsible for its products and applications using ON Semiconductor products, including compliance with all laws, regulations and safety requirements or standards, regardless of any support or applications information provided by ON Semiconductor. "Typical" parameters which may be provided in ON Semiconductor data sheets and/or specifications can and do vary in different applications and actual performance may vary over time. All operating parameters, including "Typicals" must be validated for each customer application by customer's technical experts. ON Semiconductor does not convey any license under its patent rights nor the rights of others. ON Semiconductor products are not designed, intended, or authorized for use as a critical component in life support systems or any FDA Class 3 medical devices or medical devices with a same or similar classification in a foreign jurisdiction or any devices intended for implantation in the human body. Should Buyer purchase or use ON Semiconductor products for any such unintended or unauthorized application, Buyer shall indemnify and hold ON Semiconductor and its officers, employees, subsidiaries, affiliates, and distributors harmless against all claims, costs, damages, and expenses, and reasonable attorney fees arising out of, directly or indirectly, any claim of personal injury or death associated with such unintended or unauthorized use, even if such claim alleges that ON Semiconductor was negligent regarding the design or manufacture of the part. ON Semiconductor is an Equal Opportunity/Affirmative Action Employer. This literature is subject to all applicable copyright laws and is not for resale in any manner.

PUBLICATION ORDERING INFORMATION

LITERATURE FULFILLMENT:

Literature Distribution Center for ON Semiconductor
19521 E. 32nd Pkwy, Aurora, Colorado 80011 USA
Phone: 303-675-2175 or 800-344-3860 Toll Free USA/Canada
Fax: 303-675-2176 or 800-344-3867 Toll Free USA/Canada
Email: orderlit@onsemi.com

N. American Technical Support: 800-282-9855 Toll Free
USA/Canada
Europe, Middle East and Africa Technical Support:
Phone: 421 33 790 2910
Japan Customer Focus Center
Phone: 81-3-5817-1050

ON Semiconductor Website: www.onsemi.com
Order Literature: <http://www.onsemi.com/orderlit>
For additional information, please contact your local
Sales Representative