



Chipsmall Limited consists of a professional team with an average of over 10 year of expertise in the distribution of electronic components. Based in Hongkong, we have already established firm and mutual-benefit business relationships with customers from,Europe,America and south Asia,supplying obsolete and hard-to-find components to meet their specific needs.

With the principle of “Quality Parts,Customers Priority,Honest Operation,and Considerate Service”,our business mainly focus on the distribution of electronic components. Line cards we deal with include Microchip,ALPS,ROHM,Xilinx,Pulse,ON,Everlight and Freescale. Main products comprise IC,Modules,Potentiometer,IC Socket,Relay,Connector.Our parts cover such applications as commercial,industrial, and automotives areas.

We are looking forward to setting up business relationship with you and hope to provide you with the best service and solution. Let us make a better world for our industry!



Contact us

Tel: +86-755-8981 8866 Fax: +86-755-8427 6832

Email & Skype: info@chipsmall.com Web: www.chipsmall.com

Address: A1208, Overseas Decoration Building, #122 Zhenhua RD., Futian, Shenzhen, China





REVISIONS				
DRAWN	REV	DESCRIPTION	DATE	APPROVED
CP	01	INITIAL DESIGN	6/28/17	MS

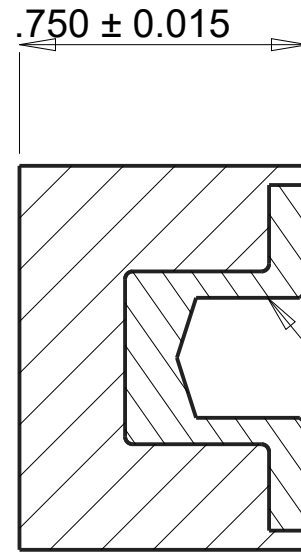
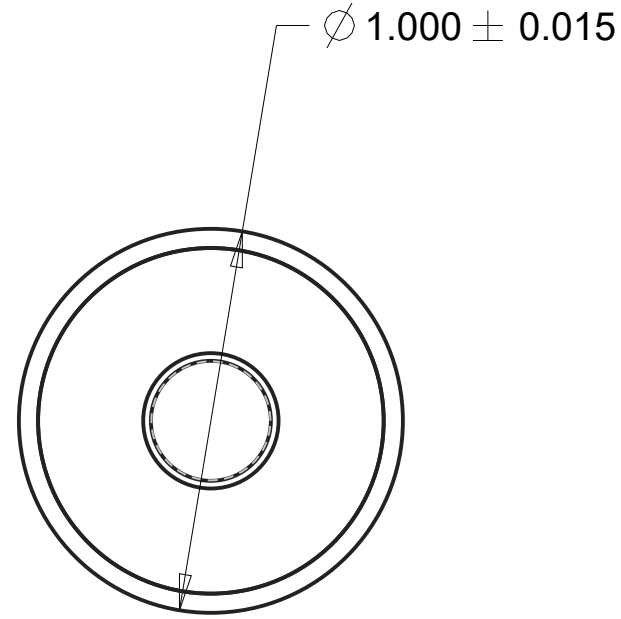

SECTION A-A

GROUP 4 FEMALE INSERT
#5/16"-18 UNC-2B

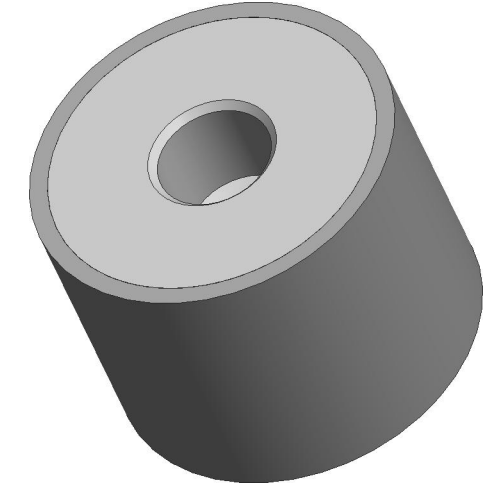

NOTES:

- CONTACT AREAS MUST BE 100% BONDED.

INSERTS:

FEMALE INSERT P/N: 021-1416

MATERIAL: S.A.E 1018 STEEL

FOR COATING DETAILS, SEE INSERT DRAWING.

MATERIAL:	AEARO TECHNOLOGIES LLC * a 3M company		
ISOLOSS SL-20300	QUALITY CONTROL: MUST COMPLY WITH AEARO TECHONOLGIES LLC SUPPLIER QUALITY MANUAL REQUIREMENTS	TITLE SANDWICH MOUNT, GROUP 4, FEMALE-BLANK, ISOLOSS SL-20300	
UNITS: IN	NOTES: ANY FEATURE NOT DIMENSIONED IN PRINT MUST BE VISIBLY PRESENT, UTILIZE 3D CAD FOR CREATION	SIZE B	ITEM CODE DWG NO. FB-400-UC31-SL20300