



Chipsmall Limited consists of a professional team with an average of over 10 year of expertise in the distribution of electronic components. Based in Hongkong, we have already established firm and mutual-benefit business relationships with customers from,Europe,America and south Asia,supplying obsolete and hard-to-find components to meet their specific needs.

With the principle of "Quality Parts,Customers Priority,Honest Operation,and Considerate Service",our business mainly focus on the distribution of electronic components. Line cards we deal with include Microchip,ALPS,ROHM,Xilinx,Pulse,ON,Everlight and Freescale. Main products comprise IC,Modules,Potentiometer,IC Socket,Relay,Connector.Our parts cover such applications as commercial,industrial, and automotives areas.

We are looking forward to setting up business relationship with you and hope to provide you with the best service and solution. Let us make a better world for our industry!



Contact us

Tel: +86-755-8981 8866 Fax: +86-755-8427 6832

Email & Skype: info@chipsmall.com Web: www.chipsmall.com

Address: A1208, Overseas Decoration Building, #122 Zhenhua RD., Futian, Shenzhen, China



FB-EM-30342-000
SHT 1.1

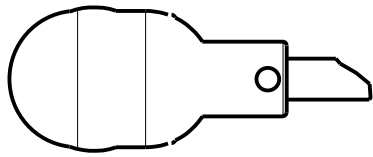

TOP VIEW
W/WINDSHIELD SHOWN
SCALE 1:1

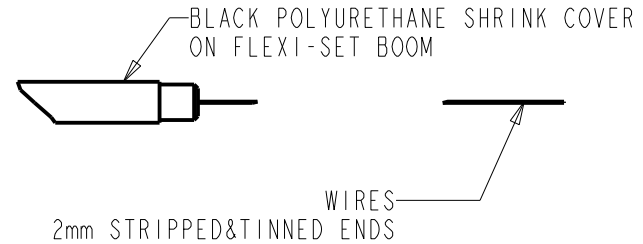
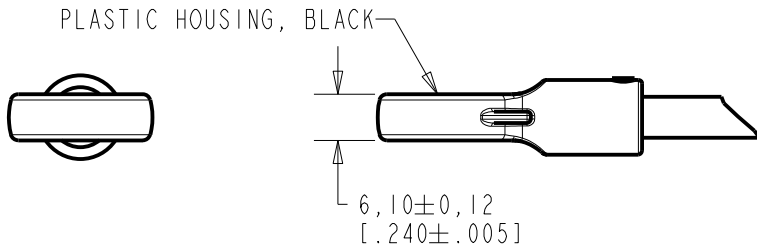
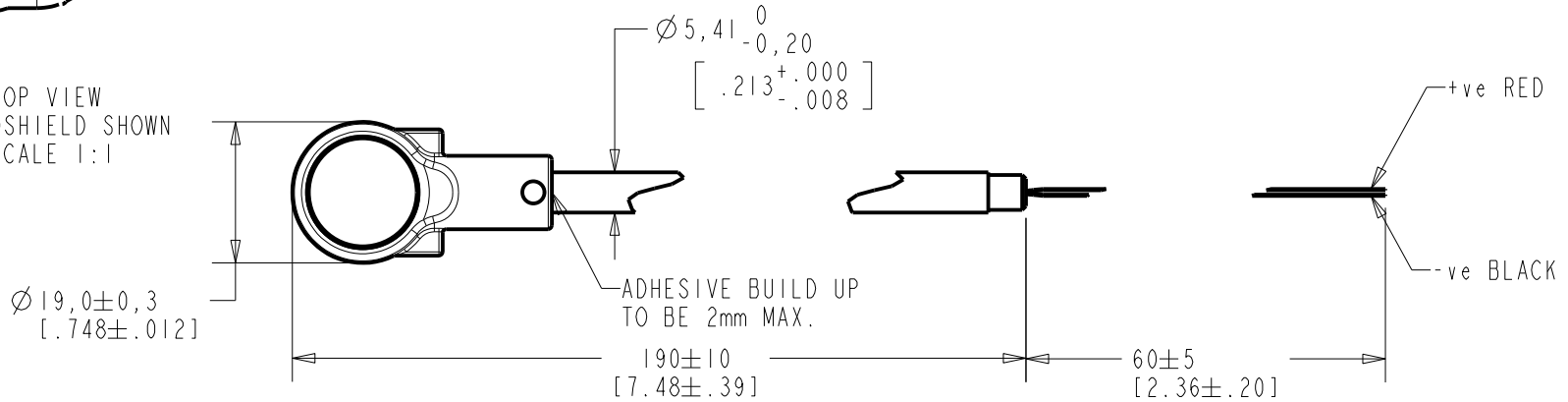

WIRE COLOR			WEIGHT GRAMS
+ve	OUTPUT	-ve	
RED	---	BLACK	---

DIMENSIONS IN MILLIMETERS [INCHES]

Revision	C.O. #	Implementation Date	RELEASE LEVEL	REVISION
C	C40101206	3-6-13	Active	C
B	C10107747	8-9-08		
A	C10107368	5-27-08		

SCALE:	1:1	DR. BY	DATE
DO NOT SCALE DRAWING		TT	5-27-08
TITLE: BOOM MICROPHONE FB-EM-30342-000		CK. BY	DATE
OUTLINE DRAWING		GJP	6-4-08
SHT 1.1		APP. BY	DATE
		GJP	6-4-08

KNOWLES ELECTRONICS
ITASCA, ILLINOIS U.S.A.

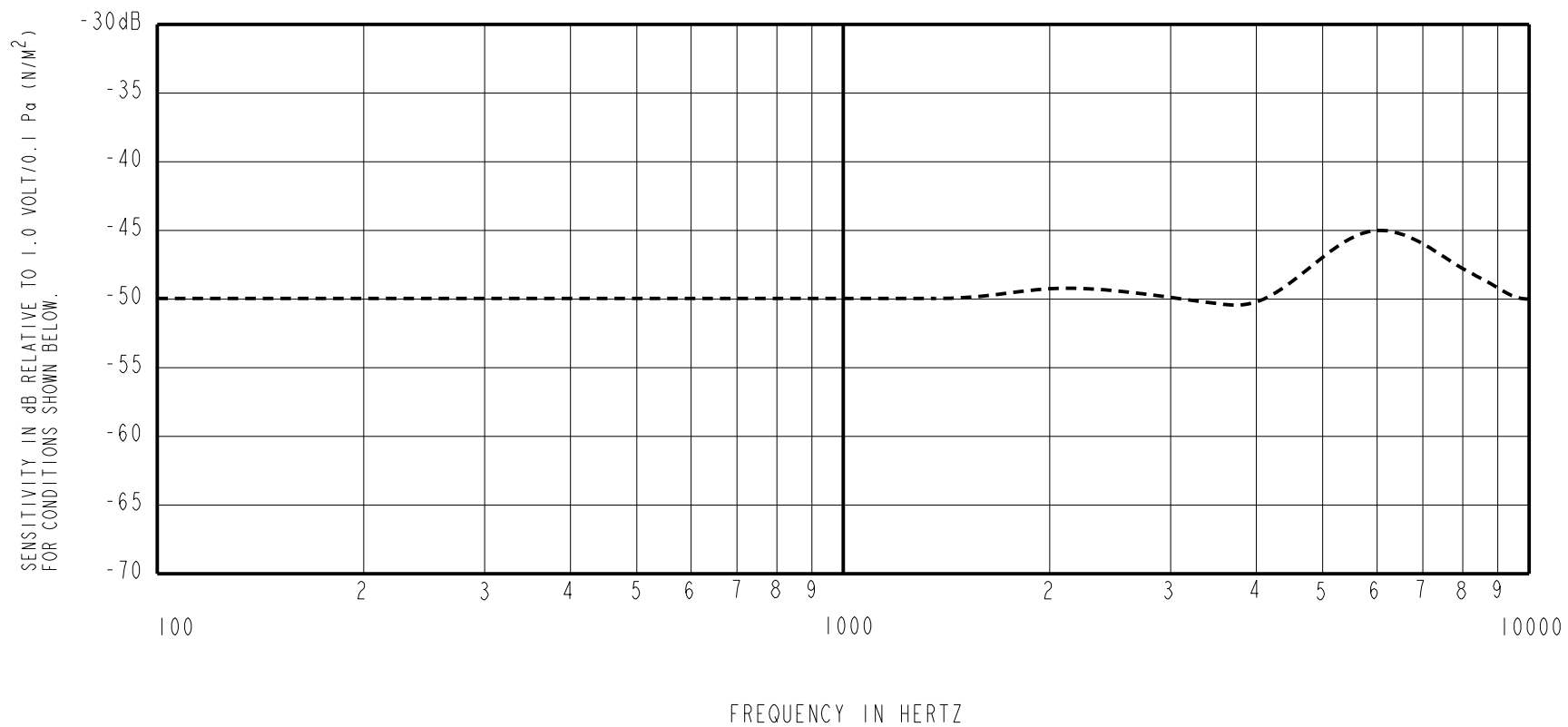

FREQUENCY	SENSITIVITY			DEVICE CONFORMITY	
	MIN.	NOM.	MAX.	RANGE OF DEVIATION FROM 1KHz	
300	---	-50.0	---	-4.0	+4.0
1000	-54.0	-50.0	-46	0.0	0.0
2000	---	-49.5	---	-4.0	---
6000	---	-45.5	---	0.0	+9

NOTES:

- MICROPHONE TO BE FUNCTIONAL WITH 10 VDC SUPPLY.
- SENSITIVITY VALUES INDICATED ON THIS SPECIFICATION ARE VALID AT 50% HUMIDITY.
- TEST CONDITIONS:
HEAD OF BOOM EXPOSED TO 74 dB SPL SWEPT SOUND FIELD AT 6mm FROM VOICE APERTURE.
ARTIFICIAL VOICE:
B & k 4227 MOUTH SIMULATOR.
- FOR MICROPHONE CAPSULE SPEC. SEE DRAWING NR-25994-D63 SHEET 2.1.
- SURVIVES SUBMERSION IN 1m OF WATER FOR 5 MINUTES; SENSITIVITY WITHIN 3dB OF INITIAL SENSITIVITY AFTER DRIED FOR 30 MINUTES AT ROOM TEMPERATURE.

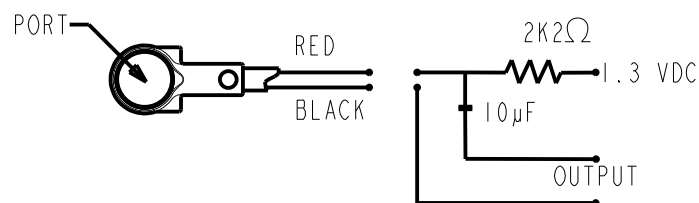
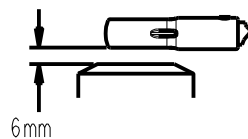

LEAD IDENTIFICATION
& TEST CIRCUIT

KNOWLES ELECTRONICS
ITASCA, ILLINOIS U.S.A.

Revision	C.O. #	Implementation Date	RELEASE LEVEL	REVISION
C	C40101206	3-6-13	Active	C
B	C10107747	8-9-08		
A	C10107368	5-27-08		
WHEN TEST LIMITS ARE USED TO ESTABLISH INCOMING INSPECTION ACCEPTANCE/REJECTION CRITERIA, CORRELATION OF TEST EQUIPMENT WITH KNOWLES IS ALSO REQUIRED FOR ELIMINATION OF EQUIPMENT AND TEST METHOD VARIATION			DR. BY	DATE
TITLE: BOOM MICROPHONE FB-EM-30342-000			TT	5-27-08
			PERFORMANCE SPECIFICATION SHT 2.1	
			CK. BY	DATE
			GJP	6-4-08
			APP. BY	DATE
			GJP	6-4-08