



Chipsmall Limited consists of a professional team with an average of over 10 year of expertise in the distribution of electronic components. Based in Hongkong, we have already established firm and mutual-benefit business relationships with customers from,Europe,America and south Asia,supplying obsolete and hard-to-find components to meet their specific needs.

With the principle of “Quality Parts,Customers Priority,Honest Operation,and Considerate Service”,our business mainly focus on the distribution of electronic components. Line cards we deal with include Microchip,ALPS,ROHM,Xilinx,Pulse,ON,Everlight and Freescale. Main products comprise IC,Modules,Potentiometer,IC Socket,Relay,Connector.Our parts cover such applications as commercial,industrial, and automotives areas.

We are looking forward to setting up business relationship with you and hope to provide you with the best service and solution. Let us make a better world for our industry!



Contact us

Tel: +86-755-8981 8866 Fax: +86-755-8427 6832

Email & Skype: info@chipsmall.com Web: www.chipsmall.com

Address: A1208, Overseas Decoration Building, #122 Zhenhua RD., Futian, Shenzhen, China



Please read this notice before using the TAIYO YUDEN products.

⚠ REMINDERS

- Product information in this catalog is as of October 2017. All of the contents specified herein are subject to change without notice due to technical improvements, etc. Therefore, please check for the latest information carefully before practical application or use of our products.

Please note that TAIYO YUDEN shall not be in any way responsible for any damages and defects in products or equipment incorporating our products, which are caused under the conditions other than those specified in this catalog or individual product specification sheets.

- Please contact TAIYO YUDEN for further details of product specifications as the individual product specification sheets are available.
- Please conduct validation and verification of our products in actual condition of mounting and operating environment before using our products.
- The products listed in this catalog are intended for use in general electronic equipment (e.g., AV equipment, OA equipment, home electric appliances, office equipment, information and communication equipment including, without limitation, mobile phone, and PC) and medical equipment classified as Class I or II by IMDRF. Please be sure to contact TAIYO YUDEN for further information before using the products for any equipment which may directly cause loss of human life or bodily injury (e.g., transportation equipment including, without limitation, automotive powertrain control system, train control system, and ship control system, traffic signal equipment, disaster prevention equipment, medical equipment classified as Class III by IMDRF, highly public information network equipment including, without limitation, telephone exchange, and base station).

Please do not incorporate our products into any equipment requiring high levels of safety and/or reliability (e.g., aerospace equipment, aviation equipment*, medical equipment classified as Class IV by IMDRF, nuclear control equipment, undersea equipment, military equipment).

*Note: There is a possibility that our products can be used only for aviation equipment that does not directly affect the safe operation of aircraft (e.g., in-flight entertainment, cabin light, electric seat, cooking equipment) if such use meets requirements specified separately by TAIYO YUDEN. Please be sure to contact TAIYO YUDEN for further information before using our products for such aviation equipment.

When our products are used even for high safety and/or reliability-required devices or circuits of general electronic equipment, it is strongly recommended to perform a thorough safety evaluation prior to use of our products and to install a protection circuit as necessary.

Please note that unless you obtain prior written consent of TAIYO YUDEN, TAIYO YUDEN shall not be in any way responsible for any damages incurred by you or third parties arising from use of the products listed in this catalog for any equipment requiring inquiry to TAIYO YUDEN or prohibited for use by TAIYO YUDEN as described above.

- Information contained in this catalog is intended to convey examples of typical performances and/or applications of our products and is not intended to make any warranty with respect to the intellectual property rights or any other related rights of TAIYO YUDEN or any third parties nor grant any license under such rights.
- Please note that the scope of warranty for our products is limited to the delivered our products themselves and TAIYO YUDEN shall not be in any way responsible for any damages resulting from a fault or defect in our products. Notwithstanding the foregoing, if there is a written agreement (e.g., supply and purchase agreement, quality assurance agreement) signed by TAIYO YUDEN and your company, TAIYO YUDEN will warrant our products in accordance with such agreement.
- The contents of this catalog are applicable to our products which are purchased from our sales offices or authorized distributors (hereinafter "TAIYO YUDEN's official sales channel"). Please note that the contents of this catalog are not applicable to our products purchased from any seller other than TAIYO YUDEN's official sales channel.
- Caution for Export**
Some of our products listed in this catalog may require specific procedures for export according to "U.S. Export Administration Regulations", "Foreign Exchange and Foreign Trade Control Law" of Japan, and other applicable regulations. Should you have any questions on this matter, please contact our sales staff.

LEADED FERRITE BEAD INDUCTORS(FB SERIES A TYPE / R TYPE)

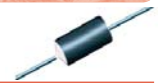

WAVE

PARTS NUMBER

*Operating Temp. : -25~+105°C (Including self-generated heat)

F	B	A	0	4	H	A	4	5	0	B	B	-	0	0
①	②	③	④	⑤	⑥	⑦								

△ = Blank space

① Series name

Code	Series name
FB	Ferrite bead

② Shape

Code	Shape
A	Axial lead
R	Radial lead

③ Dimensions of core (D)

Code	Dimensions of core (D) [mm]
03	φ 2.5
04	φ 3.5
05	5.0
06	6.0
07	7.5

④ Material

Code	Material
HA	Refer to impedance curves for material differences
VA	

⑤ Nominal impedance

Code (example)	Nominal impedance [Ω min.]
850	85
121	120

Excluding 03type

⑥ Lead configuration

Code	Lead configurations [mm]
AB	Straight lead (26mm lead space) / ammo
BB	Straight lead (52mm lead space) / ammo
KD	Formed lead (10mm pitch) / bulk
KE	Formed lead (12.5mm pitch) / bulk
KF	Formed lead / bulk (15.0mm pitch) / bulk
NA	Lead (2.5mm pitch)/bulk (FBR) Straight lead / bulk (FBA)
NB	Formed lead (crimped) / bulk
SA	Straight lead (FBR05 type) / ammo
SB	Straight lead (FBR07 type) / ammo
TB	Straight lead (FBR07 type) / ammo
UB	Radial lead formed / ammo
US	Formed lead (crimped) / bulk
VB	Dual side lead formed (crimped) / ammo
VS	Formed lead / bulk

⑦ Internal code

Code	Internal code
-00	Standard

STANDARD EXTERNAL DIMENSIONS / STANDARD QUANTITY

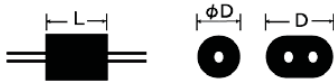

Type	Configurations				Dimensions		Standard Quantity (pcs)				
	Taping		Bulk		D	L	Type	Lead Configuration	Bulk	Taped Ammo	
FBA	03HA450 □ -00 03VA450 □ -00	AB, BB	VB, UB	NA	KD, KE, KF F: 10, 12.5, 15(0.39, 0.492, 0.591) VS, US F: 5.0(0.197)	2.5±0.2 (0.098±0.008)	4.5±0.3 (0.177±0.012)	FBA03	NA, KD, US	1000	-
		W: 26.52 (1.02, 2.05) P: 5.0 (0.197)	P: 12.7 (0.500)	KE, KF, VS					500	-	
	04HA450 □ -00 04VA450 □ -00	AB, BB	VB, UB	NA	KD, KE, KF F: 10, 12.5, 15(0.39, 0.492, 0.591) VS, US F: 5.0(0.197)	3.5±0.2 (0.138±0.008)	4.5±0.3 (0.177±0.012)		NA, KD, US	1000	-
		W: 26.52 (1.02, 2.05) P: 5.0 (0.197)	P: 12.7 (0.500)	KE, KF, VS					500	-	
04HA600 □ -00 04VA600 □ -00	AB, BB	VB	NA	KD, KE, KF F: 10, 12.5, 15(0.39, 0.492, 0.591) VS	3.5±0.2 (0.138±0.008)	6.0 ^{+0.5} ₋₀ (0.236 ^{+0.020} ₋₀)	FBA04	AB, BB	-	1000	
	W: 26.52 (1.02, 2.05) P: 5.0 (0.197)	P: 12.7 (0.500)	UB, VB					-	3000		
04HA900 □ -00 04VA900 □ -00	AB, BB	VB	NA	KE, KF F: 12.5, 15(0.492, 0.591) VS	3.5±0.2 (0.138±0.008)	9.0±0.5 (0.354±0.020)		UB, VB	-	3000	
	W: 26.52 (1.02, 2.05) P: 5.0 (0.197)	P: 12.7 (0.500)									

▶ This catalog contains the typical specification only due to the limitation of space. When you consider the purchase of our products, please check our product specification sheets. For details of each product (characteristics graph, reliability information, precautions for use, and so on), see our website (<http://www.ty-top.com/>).

Type	Configurations				Dimensions		Standard Quantity (pcs)				
	Taping		Bulk		D	L	Type	Lead Configuration	Bulk	Taped Ammo	
	Straight	Formed	Straight	Formed							
FBR	05VA121□-00	—	 P: 12.7(0.500)	—	 F: 2.5(0.098)	5.0 max. (0.197 max.)	7.5 (0.295)	FBR05	NA	1000	—
	06HA850NA-00 06VA850NA-00	—	—	—	 F: 2.5(0.098)				6.0±0.5 (0.236±0.020)	5.0 (0.197) 7.0 (0.276)	FBR06
	06HA121NA-00 06VA121NA-00	—	—	—	—	—	—	—			
	07HA850□-00 07VA850□-00	—	 P: 12.7(0.500) H: SB 18 ^{±0.0} TB 16±0.5	—	 F: 5.0(0.197)	7.5±0.5 (0.295±0.020)	5.5 (0.217) 7.5 (0.295)	FBR07	NB	1000	—
	07HA121□-00 07VA121□-00	—	—	—	—				—	—	—

Unit: mm (inch)

□ Please specify the lead configuration code.

Note: Lead diameter (ϕ d) shall fall within a range of 0.65mm±0.05mm, FBR07 types however, will have a lead diameter (ϕ d) range of 0.6mm±0.05mm.

■ PARTS NUMBER

● FBA

Parts number	EHS	Nominal impedance [Ω] (min.)	Impedance measuring frequency [MHz]		Rated current [A] (max.)		DC Resistance [Ω] (max.)	Rated current [mA] (min.)
			Material		Material			
			HA	VA	HA	VA		
FBA03△450□-00	RoHS	35	50	100	7.0	7.0	0.01	1.0
FBA04△450□-00	RoHS	45	50	100	7.0	7.0	0.01	1.0
FBA04△600□-00	RoHS	60	50	100	7.0	7.0	0.01	1.0
FBA04△900□-00	RoHS	90	50	100	7.0	7.0	0.01	1.0

● FBR

Parts number	EHS	Nominal impedance [Ω] (min.)	Impedance measuring frequency [MHz]		Rated current [A] (max.)		DC Resistance [Ω] (max.)	Rated current [mA] (min.)
			Material		Material			
			HA	VA	HA	VA		
FBR05VA121□-00	RoHS	120	—	100	—	7.0	0.01	1.0
FBR06△850NA-00	RoHS	85	50	100	7.0	7.0	0.01	1.0
FBR06△121NA-00	RoHS	120	50	100	7.0	7.0	0.01	1.0
FBR07△850□-00	RoHS	85	50	100	7.0	7.0	0.01	1.0
FBR07△121□-00	RoHS	120	50	100	7.0	7.0	0.01	1.0

※△ Please specify material codes (HA,VA) and □ lead configuration code.

▶ This catalog contains the typical specification only due to the limitation of space. When you consider the purchase of our products, please check our product specification sheets. For details of each product (characteristics graph, reliability information, precautions for use, and so on), see our website (<http://www.ty-top.com/>).

LEADED FERRITE BEAD INDUCTORS (FB SERIES A TYPE / R TYPE)

PACKAGING

① Minimum Quantity

● Axial lead (FBA)

Type	Lead Configuration	Standard quantity [pcs]	
		Bulk	Taped Ammo
FBA03	NA, KD, US	1000	—
	KE, KF, VS	500	—
	AB, BB	—	2000
	UB, VB	—	3000
FBA04	NA, KD, US	1000	—
	KE, KF, VS	500	—
	AB, BB	—	1000
	VB, UB	—	3000

● Radial lead (FBR)

Type	Lead Configuration	Standard quantity [pcs]	
		Bulk	Taped Ammo
FBR05	NA	1000	—
	SA	—	2000
FBR06	NA	1000	—
FBR07	NB	1000	—
	SB, TB	—	2000

② Bulk dimensions

Axial lead (FBA)

● NA

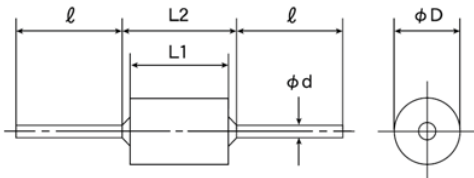

Type	Dimensions				
	ϕD	L1	L2	ϕd	ℓ
FBA03□450	2.5 ± 0.2 (0.098 ± 0.008)	4.5 ± 0.3 (0.177 ± 0.012)	6.5 max. (0.256 max.)	0.65 ± 0.05 (0.026 ± 0.002)	18 min. (0.709 min.)
FBA04□450	3.5 ± 0.2 (0.138 ± 0.008)	4.5 ± 0.3 (0.177 ± 0.012)	6.5 max. (0.256 max.)		
FBA04□600	3.5 ± 0.2 (0.138 ± 0.008)	$6.0 + 0.5 / -0$ ($0.236 + 0.020 / -0$)	8.5 max. (0.335 max.)		
FBA04□900	3.5 ± 0.2 (0.138 ± 0.008)	9.0 ± 0.5 (0.354 ± 0.020)	11.0 max. (0.433 max.)		

Unit: mm (inch)

● US

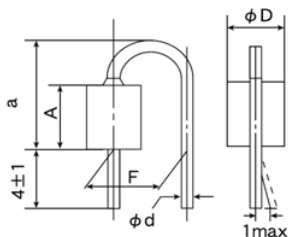

Type	Dimensions				
	ϕD	A	a	F	ϕd
FBA03□450	2.5 ± 0.2 (0.098 ± 0.008)	4.5 ± 0.3 (0.177 ± 0.012)	9.0 max. (0.354 max.)	5.0 ± 1.0 (0.197 ± 0.039)	0.65 ± 0.05 (0.026 ± 0.002)
FBA04□450	3.5 ± 0.2 (0.138 ± 0.008)	4.5 ± 0.3 (0.177 ± 0.012)	9.0 max. (0.354 max.)		

Unit: mm (inch)

▶ This catalog contains the typical specification only due to the limitation of space. When you consider the purchase of our products, please check our specification. For details of each product (characteristics graph, reliability information, precautions for use, and so on), see our Web site (<http://www.ty-top.com/>).

● KD/KE/KF

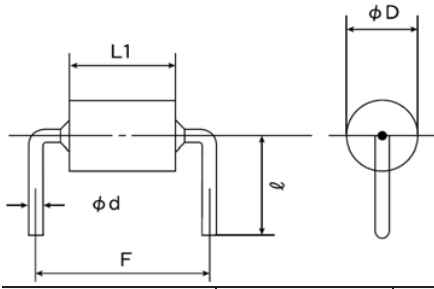

Type	Lead Symbol	Dimensions				
		ϕD	F	L1	ϕd	l
FBA03□450	KD	2.5±0.2 (0.098±0.008)	10.0±1.0 (0.394±0.039)	4.5±0.3 (0.177±0.012)	0.65±0.05 (0.026±0.020)	7.0±2.0 (0.276±0.079)
FBA04□450		3.5±0.2 (0.138±0.008)	10.0±1.0 (0.394±0.039)	4.5±0.3 (0.177±0.012)		7.5±2.0 (0.295±0.079)
FBA04□600		3.5±0.2 (0.138±0.008)	10.0±1.0 (0.394±0.039)	6.0+0.5/-0 (0.236+0.020/-0)		7.5±2.0 (0.295±0.079)
FBA03□450	KE	2.5±0.2 (0.098±0.008)	12.5±1.0 (0.492±0.039)	4.5±0.3 (0.177±0.012)	0.65±0.05 (0.026±0.020)	7.0±2.0 (0.276±0.079)
FBA04□450		3.5±0.2 (0.138±0.008)	12.5±1.0 (0.492±0.039)	4.5±0.3 (0.177±0.012)		7.5±2.0 (0.295±0.079)
FBA04□600		3.5±0.2 (0.138±0.008)	12.5±1.0 (0.492±0.039)	6.0+0.5/-0 (0.236+0.020/-0)		7.5±2.0 (0.295±0.079)
FBA04□900		3.5±0.2 (0.138±0.008)	12.5±1.0 (0.492±0.039)	9.0±0.5 (0.354±0.020)		7.5±2.0 (0.295±0.079)
FBA03□450	KF	2.5±0.2 (0.098±0.008)	15.0±1.0 (0.591±0.039)	4.5±0.3 (0.177±0.012)	0.65±0.05 (0.026±0.020)	7.0±2.0 (0.276±0.079)
FBA04□450		3.5±0.2 (0.138±0.008)	15.0±1.0 (0.591±0.039)	4.5±0.3 (0.177±0.012)		7.5±2.0 (0.295±0.079)
FBA04□600		3.5±0.2 (0.138±0.008)	15.0±1.0 (0.591±0.039)	6.0+0.5/-0 (0.236+0.020/-0)		7.5±2.0 (0.295±0.079)
FBA04□900		3.5±0.2 (0.138±0.008)	15.0±1.0 (0.591±0.039)	9.0±0.5 (0.354±0.020)		7.5±2.0 (0.295±0.079)

Unit: mm (inch)

● VS

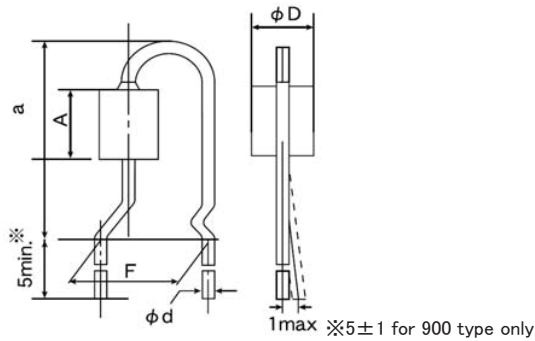

Type	Dimensions				
	ϕD	A	a	F	ϕd
FBA03□450	2.5±0.2 (0.098±0.008)	4.5±0.3 (0.177±0.012)	12.5 max. (0.492 max.)	5.0±1.0 (0.197±0.039)	0.65±0.05 (0.026±0.002)
FBA04□450	3.5±0.2 (0.138±0.008)	4.5±0.3 (0.177±0.012)	12.5 max. (0.492 max.)	5.0±1.0 (0.197±0.039)	0.65±0.05 (0.026±0.002)
FBA04□600	3.5±0.2 (0.138±0.008)	6.0+0.5/-0 (0.236+0.020/-0)	12.5 max. (0.492 max.)	5.0±1.0 (0.197±0.039)	0.65±0.05 (0.026±0.002)
FBA04□900	3.5±0.2 (0.138±0.008)	9.0±0.5 (0.354±0.020)	16.0 max. (0.630 max.)	5.0±1.0 (0.197±0.039)	0.65±0.05 (0.026±0.002)

Unit: mm (inch)

▶ This catalog contains the typical specification only due to the limitation of space. When you consider the purchase of our products, please check our specification. For details of each product (characteristics graph, reliability information, precautions for use, and so on), see our Web site (<http://www.ty-top.com/>).

Radial lead (FBR)

● NA

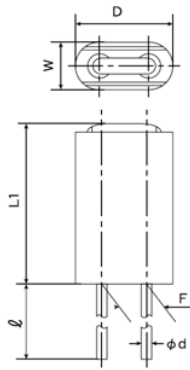

Type	Dimensions					
	D	L1	φd	l	W	F
FBR05VA121	5.0 max. (0.197 max.)	9.0 max. (0.354 max.)	0.65±0.05 (0.026±0.002)	10.0+3/-5 (0.394+0.118/-0.197)	2.5 max. (0.098 max.)	2.5±1.0 (0.098±0.039)
FBR06□850	6.0±0.5 (0.236±0.020)	7.0 max. (0.276 max.)	0.65±0.05 (0.026±0.002)	10.0+3/-5 (0.394+0.118/-0.197)	3.0±0.5 (0.118±0.020)	2.5±1.0 (0.098±0.039)
FBR06□121	6.0±0.5 (0.236±0.020)	9.0 max. (0.354 max.)	0.65±0.05 (0.026±0.002)	10.0+3/-5 (0.394+0.118/-0.197)	3.0±0.5 (0.118±0.020)	2.5±1.0 (0.098±0.039)

Unit: mm (inch)

● NB

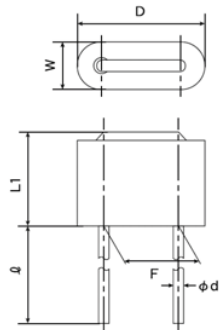

Type	Dimensions					
	D	L1	φd	l	W	F
FBR07□850	7.5±0.5 (0.295±0.020)	7.0 max. (0.276 max.)	0.6±0.05 (0.024±0.002)	5.0+1/-2 (0.197+0.039/-0.079)	2.5 max. (0.098 max.)	5.0+1/-0.5 (0.197+0.039/-0.020)
FBR07□121	7.5±0.5 (0.295±0.020)	9.0 max. (0.354 max.)	0.6±0.05 (0.024±0.002)	5.0+1/-2 (0.197+0.039/-0.079)	2.5 max. (0.098 max.)	5.0+1/-0.5 (0.197+0.039/-0.020)

Unit: mm (inch)

③ Taping Dimensions

● AB (a: 26mm) (1.02inch lead space)

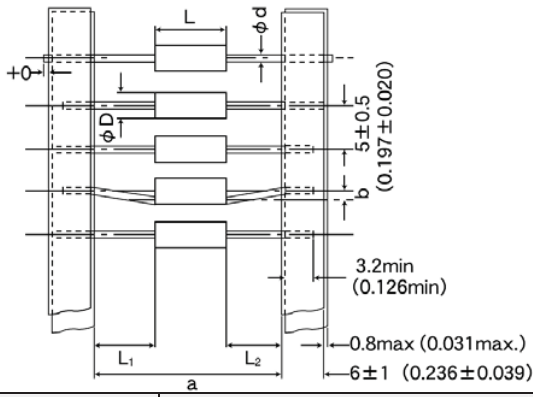

Type	Dimensions						Minimum insertion pitch
	ϕD	L	a	b	$ L_1-L_2 $	ϕd	
FBA03	2.5 ± 0.2 (0.098 ± 0.008)	4.5 ± 0.3 (0.177 ± 0.012)	$26.0 + 1.5 / -0$ ($1.02 + 0.059 / -0$)	0.8max (0.031max)	1.0 max (0.039 max)	0.65 ± 0.05 (0.026 ± 0.002)	10.0 (0.394)
FBA04□450	3.5 ± 0.2 (0.138 ± 0.008)	4.5 ± 0.3 (0.177 ± 0.012)	$26.0 + 1.5 / -0$ ($1.02 + 0.059 / -0$)	0.8max (0.031max)	1.0 max (0.039 max)	0.65 ± 0.05 (0.026 ± 0.002)	10.0 (0.394)
FBA04□600		$6.0 + 0.5 / -0$ ($0.236 + 0.020 / -0$)	$26.0 + 1.5 / -0$ ($1.02 + 0.059 / -0$)	0.8max (0.031max)	1.0 max (0.039 max)	0.65 ± 0.05 (0.026 ± 0.002)	10.0 (0.394)
FBA04□900		9.0 ± 0.5 (0.354 ± 0.020)	$26.0 + 1.5 / -0$ ($1.02 + 0.059 / -0$)	0.8max (0.031max)	1.0 max (0.039 max)	0.65 ± 0.05 (0.026 ± 0.002)	12.5 (0.492)

Unit: mm (inch)

● BB (a: 52mm) (2.05inches lead space)

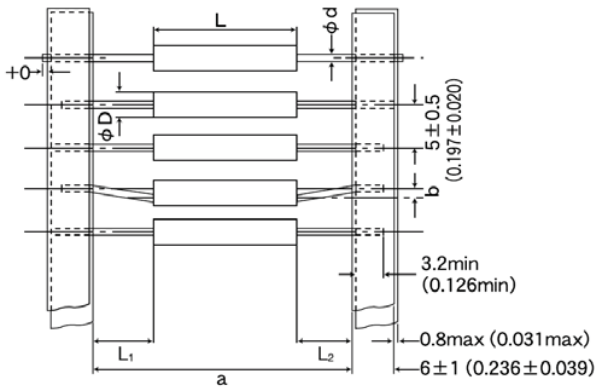

Type	Dimensions						Minimum insertion pitch
	ϕD	L	a	b	$ L_1-L_2 $	ϕd	
FBA03	2.5 ± 0.2 (0.098 ± 0.008)	4.5 ± 0.3 (0.177 ± 0.012)	$52.0 + 2 / -1$ ($2.05 + 0.079 / -0.039$)	1.2 max (0.047 max)	1.0 max (0.039 max)	0.65 ± 0.05 (0.026 ± 0.002)	10.0 (0.394)
FBA04□450	3.5 ± 0.2 (0.138 ± 0.008)	4.5 ± 0.3 (0.177 ± 0.012)	$52.0 + 2 / -1$ ($2.05 + 0.079 / -0.039$)	1.2max (0.047max)	1.0 max (0.039 max)	0.65 ± 0.05 (0.026 ± 0.002)	10.0 (0.394)
FBA04□600		$6.0 + 0.5 / -0$ ($0.236 + 0.020 / -0$)	$52.0 + 2 / -1$ ($2.05 + 0.079 / -0.039$)	1.2max (0.047 max)	1.0 max (0.039 max)	0.65 ± 0.05 (0.026 ± 0.002)	10.0 (0.394)
FBA04□900		9.0 ± 0.5 (0.354 ± 0.020)	$52.0 + 2 / -1$ ($2.05 + 0.079 / -0.039$)	1.2max (0.047 max)	1.0 max (0.039 max)	0.65 ± 0.05 (0.026 ± 0.002)	12.5 (0.492)

Unit: mm (inch)

► This catalog contains the typical specification only due to the limitation of space. When you consider the purchase of our products, please check our specification. For details of each product (characteristics graph, reliability information, precautions for use, and so on), see our Web site (<http://www.ty-top.com/>).

● SA (F: 2.5mm pitch) (0.098 inches)

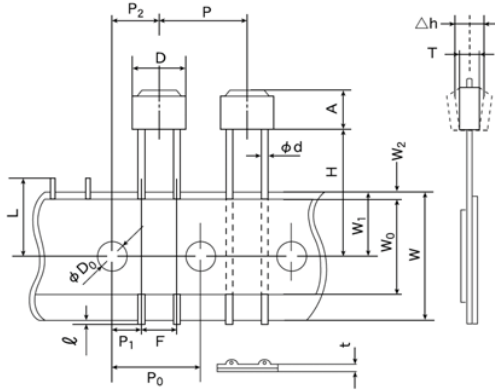

Type	Symbol	Dimensions	Symbol	Dimensions	Symbol	Dimensions
FBR05	A	121: 9.0 max. (0.354 max.)	P ₂	6.35±1.3 (0.250±0.051)	ℓ	1.0 max. (0.039 max.)
	T	2.5 max. (0.098 max.)	F	2.5+1.0/−0.5 (0.098+0.039/−0.020)	φD ₀	4.0±0.3 (0.157±0.012)
	D	5.0 max. (0.197 max.)	Δh	0.0±2.0 (0.0±0.079)	φd	0.65±0.05 (0.026±0.002)
	H	18.0+2.0/−0 (0.709+0.079/−0)	W	18.0+1.0/−0.5 (0.709+0.039/−0.020)	L	11.0 max. (0.433 max.)
	P	12.7±1.0 (0.500±0.039)	W ₀	12.5 min. (0.492 min.)	t	0.7±0.2 (0.028±0.008)
	P ₀	12.7±0.3 ※ ¹ (0.500±0.012)	W ₁	9.0+0.75/−0.5 (0.354+0.030/−0.020)	Unit: mm(inch)	
	P ₁	5.1±0.7 (0.201±0.028)	W ₂	3.0 max. ※ ² (0.118 max.)		

※¹ Accumulated error for 20 pitches is ±2mm.

※² Bonding tape must not protrude from the base tape.

● SB/TB (F: 5mm pitch) (0.197 inches)

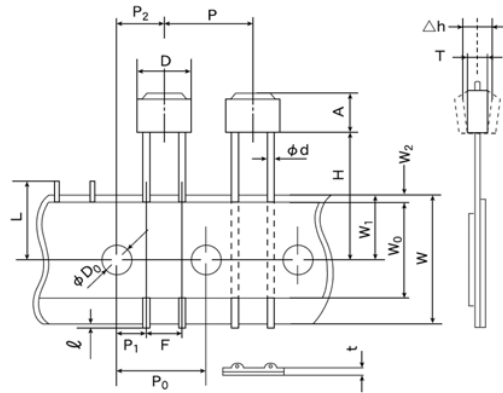

Type	Symbol	Dimensions	Symbol	Dimensions	Symbol	Dimensions
FBR07	A	121: 9.0 max. (0.354 max.)	P ₀	12.7±0.3 ※ ¹ (0.500±0.012)	W ₁	9.0+0.75/−0.5 (0.354+0.039/−0.020)
		850: 7.0 max. (0.276 max.)	P ₁	3.85±0.8 (0.152±0.028)	W ₂	3.0 max. ※ ² (0.118 max.)
	T	2.5 max. (0.098 max.)	P ₂	6.35±1.3 (0.250±0.051)	ℓ	1.0 max. (0.039 max.)
	D	7.5±0.5 (0.925±0.020)	F	5.0+1.0/−0.5 (0.197+0.039/−0.020)	φD ₀	4.0±0.3 (0.157±0.012)
	H	SB: 18.0+2.0/−0 (0.709+0.079/−0)	Δh	0.0±2.0 (0.0±0.079)	φd	0.6±0.05 (0.024±0.002)
		TB: 16.0±0.5 (0.630±0.020)	W	18.0+1.0/−0.5 (0.709+0.039/−0.020)	L	11.0 max. (0.433 max.)
	P	12.7±1.0 (0.500±0.039)	W ₀	12.5 min. (0.492 min.)	t	0.7±0.2 (0.028±0.008)

Unit: mm(inch)

※¹ Accumulated error for 20 pitches is ±2mm.

※² Bonding tape must not protrude from the base tape.

► This catalog contains the typical specification only due to the limitation of space. When you consider the purchase of our products, please check our specification. For details of each product (characteristics graph, reliability information, precautions for use, and so on), see our Web site (<http://www.ty-top.com/>).

●UB

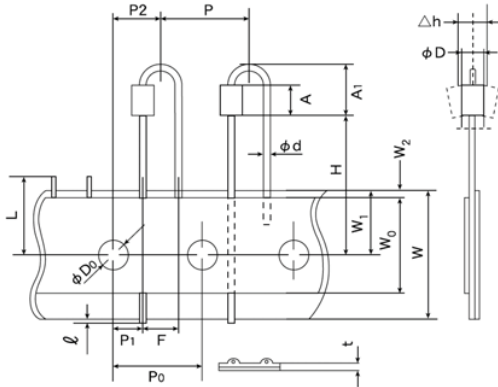

Type	Symbol	Dimensions	Symbol	Dimensions	Symbol	Dimensions	
FBA03□450 FBA04□450	A	4.5±0.3 (0.177±0.012)	P ₁	3.85±0.8 (0.152±0.032)	W ₂	3.0 max. ※2 (0.118 max.)	
	A ₁	9.0 max. (0.354 max.)	P ₂	6.35±1.3 (0.250±0.051)	ℓ	1.0 max. (0.039 max.)	
	φD	03:	2.5±0.2 (0.098±0.008)	F	5.0±1.0 (0.197±0.039)	φD ₀	4.0±0.3 (0.157±0.012)
		04:	3.5±0.2 (0.138±0.008)	Δh	0.0±2.0 (0.0±0.079)	φd	0.65±0.05 (0.026±0.002)
	H	20.0+0.5/-1.0 (0.787+0.020/-0.039)	W	18.0+1.0/-0.5 (0.709+0.039/-0.020)	L	11.0 max. (0.433 max.)	
	P	12.7±1.0 (0.500±0.039)	W ₀	12.5 min. (0.492 min.)	t	0.7±0.2 (0.028±0.008)	
P ₀	12.7±0.3 ※1 (0.500±0.012)	W ₁	9.0+0.75/-0.5 (0.354+0.030/-0.020)	Unit: mm(inch)			

※1 Accumulated error for 20 pitches is ±2mm.

※2 Bonding tape must not protrude from the base tape.

●VB 形状

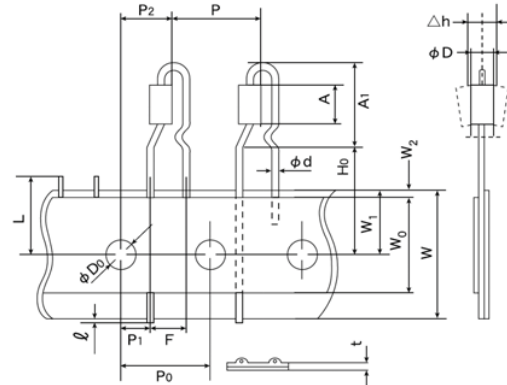

Type	Symbol	Dimensions	Symbol	Dimensions	Symbol	Dimensions	
FBA03□450 FBA04□450 FBA04□600 FBA04□900	A	450:	4.5±0.3 (0.177±0.012)	P	12.7±1.0 (0.500±0.039)	W ₁	9.0+0.75/-0.5 (0.354+0.030/-0.020)
		600:	6.0+0.5/-0 (0.236+0.020/-0)	P ₀	12.7±0.3 ※1 (0.500±0.012)	W ₂	3.0 max. ※2 (0.118 max.)
		900:	9.0±0.5 (0.354±0.020)	P ₁	3.85±0.8 (0.152±0.032)	ℓ	1.0 max. (0.039 max.)
	A ₁	450:	12.5 max.	P ₂	6.35±1.3 (0.250±0.051)	φD ₀	4.0±0.3 (0.157±0.012)
		600:	(0.492 max.)	F	5.0±1.0 (0.197±0.039)	φd	0.65±0.05 (0.026±0.002)
		900:	16.0 max. (0.630 max.)	Δh	0.0±2.0 (0.0±0.079)	L	11.0 max. (0.433 max.)
	φD	03:	2.5±0.2 (0.098±0.008)	W	18.0+1.0/-0.5 (0.709+0.039/-0.020)	t	0.7±0.2 (0.028±0.008)
		04:	3.5±0.2 (0.138±0.008)	W ₀	12.5 min. (0.492 min.)	単位: mm(inch)	
	H ₀	16.0±0.5 (0.650±0.020)					

※1 Accumulated error for 20 pitches is ±2mm.

※2 Bonding tape must not protrude from the base tape.

11. Over current		
Specified Value	CAL45 Type	No emission of smoke no firing.
	LHL□□□	There shall be no scorch or short of wire. LHLC08, LHLC10 : There shall be no firing.
	FBA/FBR	
Test Methods and Remarks	LHL□□□・CAL45 Type : Measuring current : Rated current × 2 Duration : 5 min. Number of measuring : one time	

12. Terminal strength : bending													
Specified Value	CAL45 Type	No abnormality such as cut lead, or looseness.											
	LHL□□□												
	FBA/FBR												
Test Methods and Remarks	CAL45 Type : Suspend a weight of specified mass at the end of the terminals and incline the body through the angle of 90 degrees and return it to the initial position. This operation is done over a period of 2-3 sec. Then second bend in the opposite direction shall be made. Number of bends : Two times.												
	<table border="1"> <thead> <tr> <th>Nominal wire diameter tensile</th> <th>Bending force</th> <th>Mass reference weight</th> </tr> </thead> <tbody> <tr> <td>$0.3 < \phi d \leq 0.5$</td> <td>2.5</td> <td>0.25</td> </tr> <tr> <td>$0.5 < \phi d \leq 0.8$</td> <td>5</td> <td>0.50</td> </tr> </tbody> </table>		Nominal wire diameter tensile	Bending force	Mass reference weight	$0.3 < \phi d \leq 0.5$	2.5	0.25	$0.5 < \phi d \leq 0.8$	5	0.50		
Nominal wire diameter tensile	Bending force	Mass reference weight											
$0.3 < \phi d \leq 0.5$	2.5	0.25											
$0.5 < \phi d \leq 0.8$	5	0.50											
Test Methods and Remarks	LHL□□□・FBA/FBR : Suspend a weight of specified mass at the end of the terminals and incline the body through the angle of 90 degrees and return it to the initial position. This operation is done over a period of 2-3 sec. Then second bend in the opposite direction shall be made. Number of bends : Two times.												
	<table border="1"> <thead> <tr> <th>Nominal wire diameter tensile</th> <th>Bending force</th> <th>Mass reference weight</th> </tr> </thead> <tbody> <tr> <td>$0.3 < \phi d \leq 0.5$</td> <td>2.5</td> <td>0.25</td> </tr> <tr> <td>$0.5 < \phi d \leq 0.8$</td> <td>5</td> <td>0.5</td> </tr> <tr> <td>$0.8 < \phi d \leq 1.2$</td> <td>10</td> <td>1.0</td> </tr> </tbody> </table>		Nominal wire diameter tensile	Bending force	Mass reference weight	$0.3 < \phi d \leq 0.5$	2.5	0.25	$0.5 < \phi d \leq 0.8$	5	0.5	$0.8 < \phi d \leq 1.2$	10
Nominal wire diameter tensile	Bending force	Mass reference weight											
$0.3 < \phi d \leq 0.5$	2.5	0.25											
$0.5 < \phi d \leq 0.8$	5	0.5											
$0.8 < \phi d \leq 1.2$	10	1.0											

13. Insulation resistance : between the terminals and body		
Specified Value	CAL45 Type	100MΩ min.
	LHL□□□	
	FBA/FBR	
Test Methods and Remarks	LHL□□□ : Applied voltage : 500 VDC Duration : 60 sec.	

14. Insulation resistance : between terminals and core		
Specified Value	CAL45 Type	1MΩ min.
	LHL□□□	
	FBA/FBR	
Test Methods and Remarks	FBA/FBR : Applied voltage : 100 VDC Duration : 60±5 sec.	

15. Withstanding : between the terminals and body		
Specified Value	CAL45 Type	No abnormality such as insulation damage
	LHL□□□	
	FBA/FBR	
Test Methods and Remarks	LHL□□□ : According to JIS C5101-1. Metal global method Applied voltage : 500 VDC Duration : 60 sec.	

▶ This catalog contains the typical specification only due to the limitation of space. When you consider the purchase of our products, please check our specification. For details of each product (characteristics graph, reliability information, precautions for use, and so on), see our Web site (<http://www.ty-top.com/>).

16. DC bias characteristic		
Specified Value	CAL45 Type	$\Delta L/L$: Within -10%
	LHL□□□	
	FBA/FBR	
Test Methods and Remarks	CAL45 Type : Measure inductance with application of rated current using LCR meter to compare it with the initial value.	

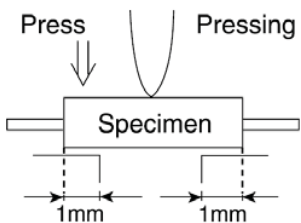
17. Body strength		
Specified Value	CAL45 Type	No abnormality as damage.
	LHL□□□	
	FBA/FBR	No abnormality such as cracks on body.
Test Methods and Remarks	<p>CAL45 Type :</p> <p>Applied force : 50N Duration : 10 sec. Speed : Shall attain to specified force in 2 sec.</p> <p>FBA :</p> <p>Applied force : $50 \pm 3N$ Duration : 30 ± 1 sec.</p> <p>Press  Pressing jig</p>	

18. Resistance to vibration		
Specified Value	CAL45 Type	$\Delta L/L$: Within $\pm 5\%$
	LHL□□□	Appearance : No abnormality $\Delta L/L$: Within $\pm 5\%$ Q change : Within $\pm 30\%$
	FBA/FBR	Appearance : No abnormality Impedance change : Within $\pm 20\%$
Test Methods and Remarks	<p>CAL45 Type :</p> <p>Directions : 2 hrs each in X, Y and Z directions total : 6hrs. Frequency range : 10 to 55 to 10Hz (1min.) Amplitude : 1.5mm Mounting method : Soldering onto printed board. Recovery : At least 1hr of recovery under the standard condition after the test, followed by the measurement within 2hrs.</p> <p>LHL□□□·FBA/FBR :</p> <p>Directions : 2 hrs each in X, Y and Z directions total : 6hrs. Frequency range : 10 to 55 to 10Hz (1min.) Amplitude : 1.5mm Mounting method : Soldering onto printed board.</p>	

19. Resistance to shock		
Specified Value	CAL45 Type	No significant abnormality in appearance
	LHL□□□	
	FBA/FBR	
Test Methods and Remarks	<p>CAL45 Type :</p> <p>Drop test</p> <p>Impact material : concrete or vinyl tile Height : 1m Total number of drops : 10 times</p>	

20. Solderability		
Specified Value	CAL45 Type	At least 75% of terminal electrode is covered by new solder.
	LHL□□□	At least 75% of terminal electrode is covered by new solder.
	FBA/FBR	At least 90% of terminal electrode is covered by new solder.
Test Methods and Remarks	CAL45 Type : Solder temperature : 230±5°C Duration : 2±0.5 sec. LHL□□□ : Solder temperature : 235±5°C Duration : 2±0.5 sec. Immersion depth : Up to 1.5mm from bottom of case. FBA/FBR : Solder temperature : 230±5°C Duration : 3±1 sec. Immersion depth : Up to 1.5mm from terminal root.	

21. Resistance to soldering heat		
Specified Value	CAL45 Type	ΔL/L : Within ±5%
	LHL□□□	No significant abnormality in appearance Inductance change : Within ±5% Q change : Within ±30%
	FBA/FBR	No significant abnormality in appearance Impedance change : Within ±20%
Test Methods and Remarks	CAL45 Type : Solder temperature : 270±5°C Duration : 5±0.5 sec. One time Immersed conditions : Inserted into substrate with t=1.6mm Recovery : At least 1hr of recovery under the standard condition after the test, followed by the measurement within 2hrs. LHL□□□ : Solder bath method : Solder temperature : 260±5°C Duration : 10±1 sec. : Up to 1.5mm from the bottom of case. Manual soldering : Solder temperature : 350±10°C (At the tip of soldering iron) Duration : 5±1 sec. : Up to 1.5mm from the bottom of case. Caution : No excessive pressing shall be applied to terminals. Recovery : 1 to 2hrs of recovery under the standard condition after the test. FBA/FBR : Solder bath method: Condition 1 : Solder temperature : 260±5°C Duration : 10±1 sec. Immersion depth : Up to 1.5mm from the terminal root. Condition 2 : Solder temperature : 350±5°C Duration : 3±1 sec. Immersion depth : Up to 1.5mm from the terminal root. Recovery : 3hrs of recovery under the standard condition after the test.	

22. Resistance to solvent		
Specified Value	CAL45 Type	Please avoid the ultrasonic cleaning of this product.
	LHL□□□	
	FBA/FBR	No significant abnormality in appearance Impedance change : Within ±20%
Test Methods and Remarks	FBA/FBR : Solvent temperature : 20~25°C Duration : 30±5 sec. Solvent type : Acetone Recovery : 3hrs of recovery under the standard condition after the test.	

▶ This catalog contains the typical specification only due to the limitation of space. When you consider the purchase of our products, please check our specification. For details of each product (characteristics graph, reliability information, precautions for use, and so on), see our Web site (<http://www.ty-top.com/>).

23. Thermal shock																	
Specified Value	CAL45 Type	$\Delta L/L$: Within $\pm 10\%$															
	LHL□□□	Appearance : No abnormality Inductance change : Within $\pm 10\%$ Q change : Within $\pm 30\%$															
	FBA/FBR	Appearance : No abnormality Impedance change : Within $\pm 20\%$															
Test Methods and Remarks	CAL45 Type: Conditions for 1 cycle																
	<table border="1"> <thead> <tr> <th>Step</th> <th>Temperature (°C)</th> <th>Duration (min.)</th> </tr> </thead> <tbody> <tr> <td>1</td> <td>-25+0/-3</td> <td>30±3</td> </tr> <tr> <td>2</td> <td>Room temperature</td> <td>Within 3</td> </tr> <tr> <td>3</td> <td>+85+2/-0</td> <td>30±3</td> </tr> <tr> <td>4</td> <td>Room temperature</td> <td>Within 3</td> </tr> </tbody> </table>	Step	Temperature (°C)	Duration (min.)	1	-25+0/-3	30±3	2	Room temperature	Within 3	3	+85+2/-0	30±3	4	Room temperature	Within 3	
	Step	Temperature (°C)	Duration (min.)														
	1	-25+0/-3	30±3														
	2	Room temperature	Within 3														
3	+85+2/-0	30±3															
4	Room temperature	Within 3															
Number of cycles : 5 cycles																	
Recovery : At least 1hr of recovery under the standard condition after the removal from test chamber, followed by the measurement within 2hrs.																	
LHL□□□•FBA/FBR: According to JIS C60068-2-14.																	
Test Methods and Remarks	Conditions for 1 cycle																
	<table border="1"> <thead> <tr> <th>Step</th> <th>Temperature (°C)</th> <th>Duration (min.)</th> </tr> </thead> <tbody> <tr> <td>1</td> <td>Minimum operating temperature</td> <td>30±3</td> </tr> <tr> <td>2</td> <td>Room temperature</td> <td>Within 3</td> </tr> <tr> <td>3</td> <td>Maximum operating temperature</td> <td>30±3</td> </tr> <tr> <td>4</td> <td>Room temperature</td> <td>Within 3</td> </tr> </tbody> </table>	Step	Temperature (°C)	Duration (min.)	1	Minimum operating temperature	30±3	2	Room temperature	Within 3	3	Maximum operating temperature	30±3	4	Room temperature	Within 3	
	Step	Temperature (°C)	Duration (min.)														
	1	Minimum operating temperature	30±3														
	2	Room temperature	Within 3														
3	Maximum operating temperature	30±3															
4	Room temperature	Within 3															
Number of cycles : 10 cycles [LHL□□□]																	
Recovery : 5 cycles (FBA/ FBR)																	
: 1 to 2hrs of recovery under the standard condition after the removal from the test chamber. [LHL□□□]																	
: 3hrs of recovery under the standard condition after the removal from the test chamber. (FBA/ FBR)																	

24. Damp heat		
Specified Value	CAL45 Type	$\Delta L/L$: Within $\pm 10\%$
	LHL□□□	
	FBA/FBR	Appearance : No abnormality Impedance change : Within $\pm 20\%$
Test Methods and Remarks	CAL45 Type :	
	Temperature	: 40±2°C
	Humidity	: 90~95%RH
	Duration	: 1000 hrs
	Recovery	: At least 1hr of recovery under the standard removal from test chamber, followed by the measurement within 2hrs.
Test Methods and Remarks	FBA/FBR :	
	Temperature	: 60±2°C
	Humidity	: 90~95%RH
	Duration	: 1000 hrs
	Recovery	: 3hrs of recovery under the standard condition after the removal from the test chamber.

25. Loading under damp heat		
Specified Value	CAL45 Type	$\Delta L/L$: Within $\pm 10\%$
	LHL□□□	Appearance : No abnormality Inductance change : Within $\pm 10\%$ Q change : Within $\pm 30\%$
	FBA/FBR	
Test Methods and Remarks	CAL45 Type : Temperature : $40 \pm 2^\circ\text{C}$ Humidity : $90 \sim 95\% \text{RH}$ Duration : 1000 hrs Applied current : Rated current Recovery : At least 1hr of recovery under the standard removal from test chamber, followed by the measurement within 2hrs. LHL□□□ : Temperature : $40 \pm 2^\circ\text{C}$ Humidity : $90 \sim 95\% \text{RH}$ Duration : $1000 + 48 / -0$ hrs Applied current : Rated current Recovery : 1 to 2hrs of recovery under the standard condition after the removal from the test chamber.	

26. Loading at high temperature		
Specified Value	CAL45 Type	$\Delta L/L$: Within $\pm 10\%$
	LHL□□□	
	FBA/FBR	
Test Methods and Remarks	CAL45 Type : Temperature : $85 \pm 2^\circ\text{C}$ Duration : 1000 hrs Applied current : Rated current Recovery : At least 1hr of recovery under the standard removal from test chamber, followed by the measurement within 2hrs.	

27. Low temperature life test		
Specified Value	CAL45 Type	$\Delta L/L$: Within $\pm 10\%$
	LHL□□□	Appearance : No abnormality Inductance change : Within $\pm 10\%$ Q change : Within $\pm 30\%$
	FBA/FBR	
Test Methods and Remarks	CAL45 Type : Temperature : $-25 \pm 2^\circ\text{C}$ Duration : 1000 hrs Recovery : At least 1hr of recovery under the standard removal from test chamber, followed by the measurement within 2hrs. LHL□□□ : Temperature : $-40 \pm 3^\circ\text{C}$ Duration : $1000 + 48 / -0$ hrs Recovery : 1 to 2hrs of recovery under the standard condition after the removal from the test chamber.	

28. High temperature life test		
Specified Value	CAL45 Type	
	LHL□□□	Appearance : No abnormality Inductance change : Within $\pm 10\%$ Q change : Within $\pm 30\%$
	FBA/FBR	
Test Methods and Remarks	LHL□□□ : Temperature : $105 \pm 2^\circ\text{C}$ Duration : $1000 + 48 / -0$ hrs Recovery : 1 to 2hrs of recovery under the standard condition after the removal from the test chamber.	

► This catalog contains the typical specification only due to the limitation of space. When you consider the purchase of our products, please check our specification. For details of each product (characteristics graph, reliability information, precautions for use, and so on), see our Web site (<http://www.ty-top.com/>).

AXIAL LEADED INDUCTORS (CAL Type)、 RADIAL LEADED INDUCTORS (LH Type)、 LEADED FERRITE BEAD INDUCTORS (FB Series A Type/R Type)

■ PRECAUTIONS

1. Circuit Design

Precautions	<p>◆ Operating environment</p> <p>1. The products described in this specification are intended for use in general electronic equipment, (office supply equipment, telecommunications systems, measuring equipment, and household equipment). They are not intended for use in mission-critical equipment or systems requiring special quality and high reliability (traffic systems, safety equipment, aerospace systems, nuclear control systems and medical equipment including life-support systems,) where product failure might result in loss of life, injury or damage. For such uses, contact TAIYO YUDEN Sales Department in advance.</p>
-------------	--

2. PCB Design

Precautions	<p>◆ Design</p> <p>1. Please design insertion pitches as matching to that of leads of the component on PCBs.</p>
Technical considerations	<p>◆ Design</p> <p>1. When Inductors are mounted onto a PC board, hole dimensions on the board should match the lead pitch of the component, if not, it will cause breakage of the terminals or cracking of terminal roots covered with resin as excess stress travels through the terminal legs.</p>

3. Considerations for automatic placement

Precautions	<p>◆ Adjustment of mounting machine</p> <p>1. Excessive impact load should not be imposed on the products when mounting onto the PC boards. 2. Mounting and soldering conditions should be checked beforehand.</p>
Technical considerations	<p>◆ Adjustment of mounting machine</p> <p>1. When installing products, care should be taken not to apply distortion stress as it may deform the products.</p>

4. Soldering

Precautions	<p>◆ Wave soldering</p> <p>1. Please refer to the specifications in the catalog for a wave soldering. 2. Do not immerse the entire inductor in the flux during the soldering operation.</p> <p>◆ Lead free soldering</p> <p>1. When using products with lead free soldering, we request to use them after confirming adhesion, temperature of resistance to soldering heat, soldering etc sufficiently.</p> <p>◆ Recommended conditions for using a soldering iron:</p> <ul style="list-style-type: none"> • Put the soldering iron on the land-pattern. • Soldering iron's temperature – Below 350°C • Duration – 3 seconds or less • The soldering iron should not directly touch the inductor. <p>◆ Reflow soldering</p> <p>1. As for reflow soldering, please contact our sales staff.</p>
Technical considerations	<p>◆ Lead free soldering</p> <p>1. If products are used beyond the range of the recommended conditions, heat stresses may deform the products, and consequently degrade the reliability of the products.</p> <p>◆ Recommended conditions for using a soldering iron</p> <p>If products are used beyond the range of the recommended conditions, heat stresses may deform the products, and consequently degrade the reliability of the products.</p>

5. Cleaning

Precautions	<p>◆ Cleaning conditions</p> <p>1. CAL type, LH type Please do not do cleaning by a supersonic wave.</p>
Technical considerations	<p>◆ Cleaning conditions</p> <p>1. CAL type, LH type, If washing by supersonic waves, supersonic waves may deform products.</p>

▸ This catalog contains the typical specification only due to the limitation of space. When you consider the purchase of our products, please check our specification. For details of each product (characteristics graph, reliability information, precautions for use, and so on), see our Web site (<http://www.ty-top.com/>).

6. Handling	
Precautions	<ul style="list-style-type: none"> ◆Handling <ol style="list-style-type: none"> 1. Keep the inductors away from all magnets and magnetic objects. ◆Mechanical considerations <ol style="list-style-type: none"> 1. Please do not give the inductors any excessive mechanical shocks. 2. LH type <ul style="list-style-type: none"> If inductors are dropped onto the floor or a hard surface they should not be used. ◆Packing <ol style="list-style-type: none"> 1. Please do not give the inductors any excessive mechanical shocks. In loading, please pay attention to handling indication mentioned in a packing box (a loading direction / number of maximum loading / fragile item).
Technical considerations	<ul style="list-style-type: none"> ◆Handling <ol style="list-style-type: none"> 1. There is a case that a characteristic varies with magnetic influence. ◆Mechanical considerations <ol style="list-style-type: none"> 1. There is a case to be damaged by a mechanical shock. 2. LH type <ul style="list-style-type: none"> There is a case to be broken by a fall. ◆Packing <ol style="list-style-type: none"> 1. There is a case that a lead wire could be deformed by a fall or an excessive shock.
7. Storage conditions	
Precautions	<ul style="list-style-type: none"> ◆Storage <ol style="list-style-type: none"> 1. To maintain the solderability of terminal electrodes and to keep the packing material in good condition, temperature and humidity in the storage area should be controlled. Recommended conditions <ul style="list-style-type: none"> •Ambient temperature 0~40°C •Humidity Below 70% RH <p>The ambient temperature must be kept below 30°C. Even under ideal storage conditions, solderability of products electrodes may decrease as time passes. For this reason, inductors should be used within one year from the time of delivery. In case of storage over 6 months, solderability shall be checked before actual usage.</p>
Technical considerations	<ul style="list-style-type: none"> ◆Storage <ol style="list-style-type: none"> 1. Under a high temperature and humidity environment, problems such as reduced solderability caused by oxidation of terminal electrodes and deterioration of taping/packaging materials may take place.