



Chipsmall Limited consists of a professional team with an average of over 10 year of expertise in the distribution of electronic components. Based in Hongkong, we have already established firm and mutual-benefit business relationships with customers from,Europe,America and south Asia,supplying obsolete and hard-to-find components to meet their specific needs.

With the principle of "Quality Parts,Customers Priority,Honest Operation,and Considerate Service",our business mainly focus on the distribution of electronic components. Line cards we deal with include Microchip,ALPS,ROHM,Xilinx,Pulse,ON,Everlight and Freescale. Main products comprise IC,Modules,Potentiometer,IC Socket,Relay,Connector.Our parts cover such applications as commercial,industrial, and automotives areas.

We are looking forward to setting up business relationship with you and hope to provide you with the best service and solution. Let us make a better world for our industry!



Contact us

Tel: +86-755-8981 8866 Fax: +86-755-8427 6832

Email & Skype: info@chipsmall.com Web: www.chipsmall.com

Address: A1208, Overseas Decoration Building, #122 Zhenhua RD., Futian, Shenzhen, China



Product Specification

10Gb/s Laserwire™ Serial Data Link Active Cable

FCBP110LD1Lxx

PRODUCT FEATURES

- Single 1.0 – 10.3125 Gb/s bi-directional link.
- RoHS-6 compliant (lead-free)
- Available in lengths of 3, 5, 10, 20 and 30m
- Metal enclosure for low EMI
- Single 3.3V power supply
- Low power dissipation: <500mW typical per end
- Operating temperature range: 0°C to 60°C
- RJ-45 width
- Red/Green LED indicators



APPLICATIONS

- 1/10 Gigabit Ethernet
- 1/2/4/8G Fibre Channel
- InfiniBand x1
- High Performance Computing Interconnects
- SATA/SAS
- HDMI
- PCI-e x1

Finisar's Laserwire™ active cables provide the lowest-cost serial data link solution for up to 10 Gb/s, while providing a very lightweight, low-EMI and low-power alternative to comparable short reach solutions. Laserwire™ operates independently of protocol and can thus be used in a wide range of applications. Laserwire™ plugs into the Laserwire™ Jack (P/N FCBJ110LE1), a small-footprint host-board connector. In addition, connection to SFP+, QSFP or XFP ports is possible using Laserwire™ SFP+, QSFP or XFP adapters (P/N FTLX0071D4BNL, FTLX00Q1D4BNL or FTLX0011D4BNL, respectively). Laserwire™ utilizes a limiting receiver, avoiding the challenges of a linear receiver interface.

PRODUCT SELECTION

FCBP110LD1L03	3-meter cable
FCBP110LD1L05	5-meter cable
FCBP110LD1L10	10-meter cable
FCBP110LD1L20	20-meter cable
FCBP110LD1L30	30-meter cable

Finisar

I. Pin Descriptions

Pin	Symbol	Name/Description	Ref.
1	V _{EE}	Ground	1
2	TX-	Transmitter Inverted DATA in	
3	TX+	Transmitter Non-Inverted DATA in	
4	V _{EE}	Ground	1
5	V _{CC}	Power Supply (+3.3V ± 5%)	
6	F	Fault signal	2
7	CAB-ABS	Cable absent, connected to Vee within cable plug via a resistor < 500Ω	3
8	NC	NC	4
9	V _{EE}	Ground	1
10	RX+	Receiver Non-inverted DATA out	
11	RX-	Receiver Inverted DATA out	
12	V _{EE}	Ground	1

Notes:

1. Circuit ground is internally isolated from chassis ground.
2. Open collector output. Should be pulled up with 4.7kΩ - 10kΩ on host board to a voltage between 2.0V and 3.6V. High indicates a fault condition.
3. Should be pulled up with 4.7kΩ - 10kΩ on host board to a voltage between 2.0V and 3.6V. High indicates no cable present
4. Reserved for future applications. No Connect in Host.

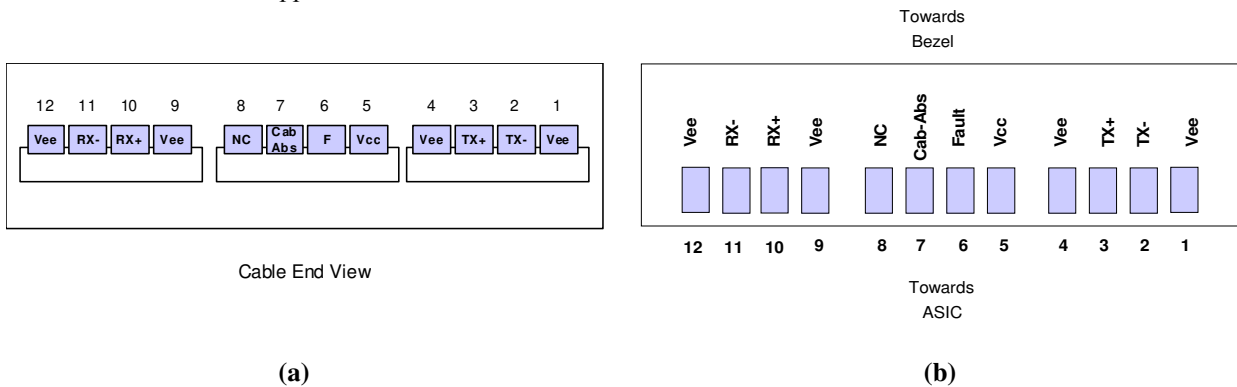

Figure 1. Pinout: (a) Cable plug end view, (b) host board decal top view.

II. Absolute Maximum Ratings

Parameter	Symbol	Min	Typ	Max	Unit	Ref.
Maximum Supply Voltage	V _{CC}	-0.5		4.0	V	
Storage Temperature	T _S	-20		+70	°C	
Case Operating Temperature	T _{OP}	0		60	°C	
Relative Humidity	RH	0		85	%	1

Notes:

1. Non-condensing.

III. Electrical Characteristics ($T_{OP} = 0$ to 60°C , $V_{CC} = 3.3 \pm 5\%$ Volts)

Parameter	Symbol	Min	Typ	Max	Unit	Ref.
Supply Voltage	Vcc	3.135		3.465	V	
Supply Current	Icc		150	200	mA	
Link Turn-On Time						
Transmit Turn-On Time				1	ms	1
Transmitter						
Differential data input swing	Vin,pp	180		800	mVpp	2
Receiver						
Differential data output swing	Vout,pp	450	700	850	mVpp	3
Power Supply Ripple Tolerance	PSR	33			mVpp	4

Notes:

1. From power-on and end of any fault conditions.
2. DC coupled internally. See Figure 2 for input eye mask requirements. Self-biasing 100Ω differential input. **Must be AC-coupled on HOST.**
3. DC Coupled with 100Ω differential output impedance. **Must be AC-coupled on HOST.** See Figure 3 for output eye mask.
4. All transceiver specifications are guaranteed with the given power supply sinusoidal modulation up to specified amplitude over a range of 10 Hz to 10 MHz applied through the power supply filtering network shown in Figure 6. See SFF-8431 Rev 4.2 (SFP+) specification section D.17.3 Power Supply Tolerance Testing for the test methodology but with the module replaced by a 15Ω load for amplitude calibration.

IV. High Speed Electrical Characteristics ($T_{OP} = 0$ to $60^{\circ}C$, $V_{CC} = 3.3 \pm 5\%$ Volts)

Parameter – Transmitter Inputs	Symbol	Conditions	Min	Typ	Max	Units	Ref.
Reference Differential Input Impedance	Z_d			100		Ω	
Termination Mismatch	ΔZ_M				5	%	1
Input AC Common Mode Voltage					25	mV (RMS)	
Differential Input Return Loss	SDD11	0.01-1.0 GHz			-12	dB	
		1.0 – 11.1 GHz				dB	2
Differential to Common Mode Loss	SCD11	0.01-11.1 GHz			-10	dB	3

Notes:

1. See SFF-8431 Rev 4.2 (SFP+) section D.15 Termination Mismatch for definition & test recommendations
2. Return Loss given by equation $SDD11(dB) = -12.9 + 0.9 \cdot f$, with f in GHz. See Figure 4
3. Common mode reference impedance is 25Ω . Differential to common mode conversion relates to generation of EMI.

Transmitter Input Jitter Specification	Symbol	Min	Typ	Max	Units	Ref.
Total Jitter	TJ_{IN}			0.38	UI	1
Data Dependent Jitter	DDJ_{IN}			0.15	UI	1
Uncorrelated Jitter	UJ_{IN}			0.029	UI _{rms}	1,2

Notes:

1. Additional host margin to SFF-8431 rev 4.2. Provided to allow use of SFP+ adapters (P/N FTLX0071D4BNL).
2. Derived here by scaling the SFF-8431 rev4.2 spec of 0.023 by the relative increase in the non-data dependent jitter over the SFF-8431 rev 4.2 spec: $[(0.38-0.15) / (0.28 - 0.10)] * 0.023$ UI_{rms}.

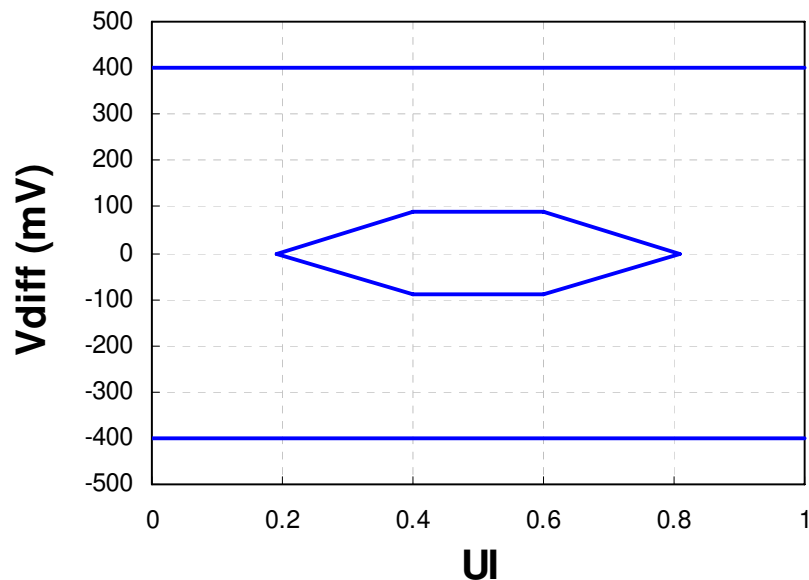

Figure 2. Transmitter Input Differential Signal Condition Mask

Parameter – Receiver Outputs	Symbol	Conditions	Min	Typ	Max	Units	Ref.
Reference Differential Output Impedance	Z_d			100		Ω	
Termination Mismatch	ΔZ_M				5	%	1
Output AC Common Mode Voltage		See XFP MSA E.5			15	mV_{RMS}	
Output Rise and Fall time (20% to 80%)	t_{RH}, t_{FH}		24			ps	
Differential Output Return Loss	SDD22	0.01-1.0 GHz			-12	dB	
		1.0 – 11.1 GHz				dB	2
Common Mode Output Return Loss	SCC22	0.01-2.5 GHz			-6	dB	3
		2.5-11.1 GHz			-3	dB	3

Notes:

1. See SFF8431 Rev 4.2 (SFP+) section D.15 Termination Mismatch for definition and test recommendations
2. Differential Return Loss given by equation $SDD22(dB) = -12.9 + 0.9 \cdot f$, with f in GHz. See Figure 4
3. Common mode reference impedance is 25Ω .

Receiver Output Jitter Specification	Symbol	Min	Typ	Max	Units	Ref.
Deterministic Jitter	DJ_{OUT}			0.38	UI	1,2
Total Jitter	TJ_{OUT}			0.64	UI	1,2

Notes:

1. When transmitter input jitter specs are met.
2. Additional host margin to SFF-8431 rev 4.2. Provided also to allow use of passive SFP+ adapters

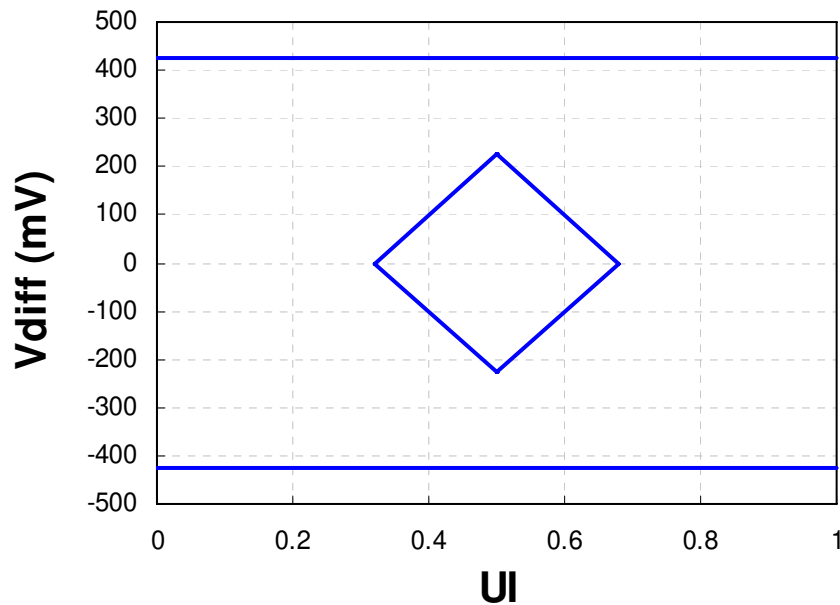

Figure 3. Receiver Output Differential Signal Mask

Finisar

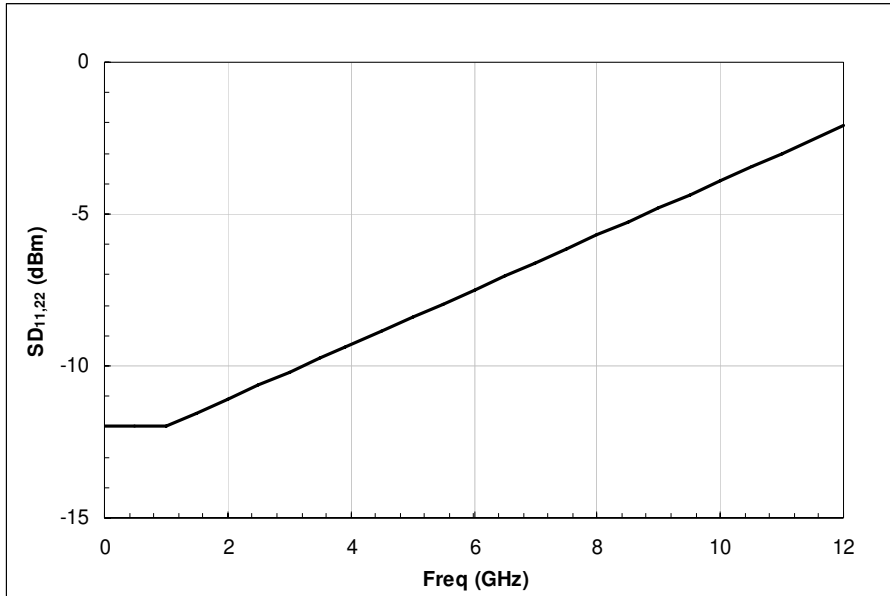

Figure 4. Maximum Transmitter Input and Receiver Output Differential Return Loss

V. General Specifications

Data Rate Specifications	Symbol	Min	Typ	Max	Units	Ref.
Bit Rate	BR	1000		103125	Mb/sec	1
Bit Error Ratio	BER			10^{-12}		2

Notes:

- 1/10 Gigabit Ethernet and 1/2/4/8G Fibre Channel compliant.
- Tested with a PRBS $2^{31}-1$ test pattern.

VI. Environmental Specifications

Finisar active cables have an operating temperature range from 0°C to +60°C case temperature.

Environmental Specifications	Symbol	Min	Typ	Max	Units	Ref.
Case Operating Temperature	T _{op}	0		60	°C	
Storage Temperature	T _{sto}	-40		85	°C	

VII. Regulatory Compliance

The FCBP110LD1Lxx Laserwire, which contains laser devices, is also a Class 1 laser product and complies with 21CFR 1040.10 and 1040.11 except for deviations pursuant to Laser Notice No. 50, dated June 24, 2007, and it complies with EN(IEC) 60825 Edition 1.2 regulations. The FCBP110LD1Lxx Laserwire is also RoHS Compliant.

Copies of certificates are available at Finisar Corporation upon request.

VIII. Mechanical Specifications

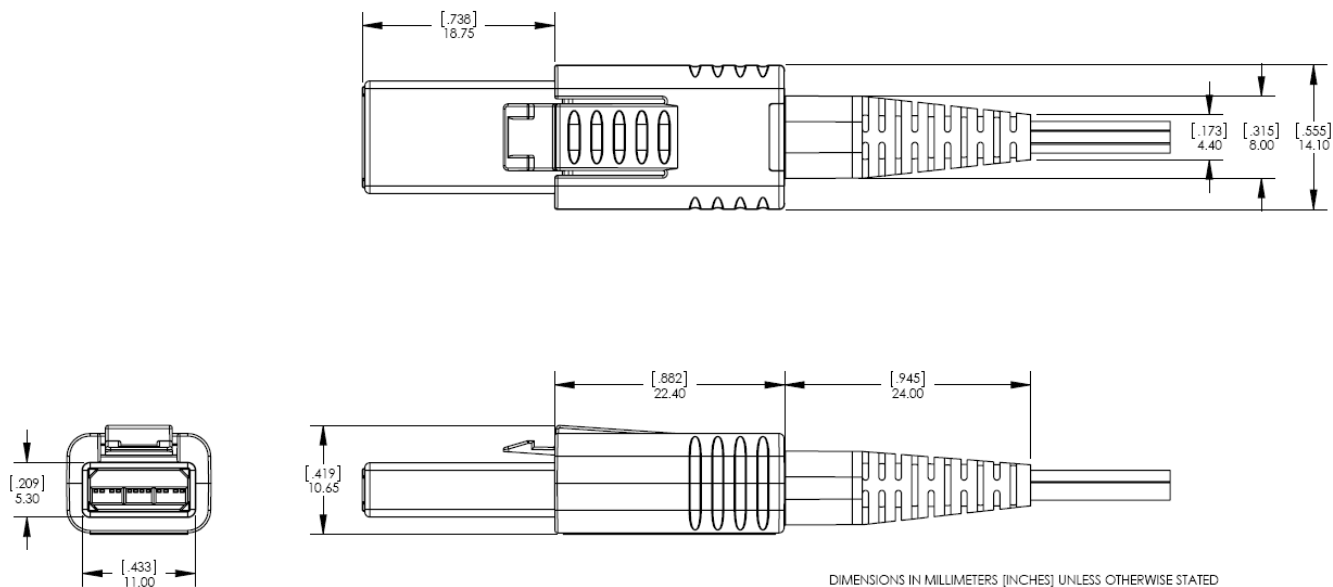

Figure 5. Side and Plug end-views.

Insertion, Extraction and Retention Forces. Bend Radius	Min	Max	Units	Notes
Cable Tensile Load (Short Term)		100	Newtons	
Cable Tensile Load (Long Term)		100	Newtons	
Crush Resistance	100		Newtons/mm	FOTP-41
Impact Resistance	0.5		Newton-m	FOTP-25
Flexing	300		Cycles	FOTP-104
Twist Bend				Exceeds FOTP-85
Cable to Laserwire Plug Connection		58	Newtons	Same as SFP/SFP+
Bend Radius	10		mm	

For details of the Laserwire™ Jack (P/N FCBJ110LE1) and recommended PCB layout and bezel recommendations, please refer to the Laserwire™ Jack datasheet.

IX. LED Operation

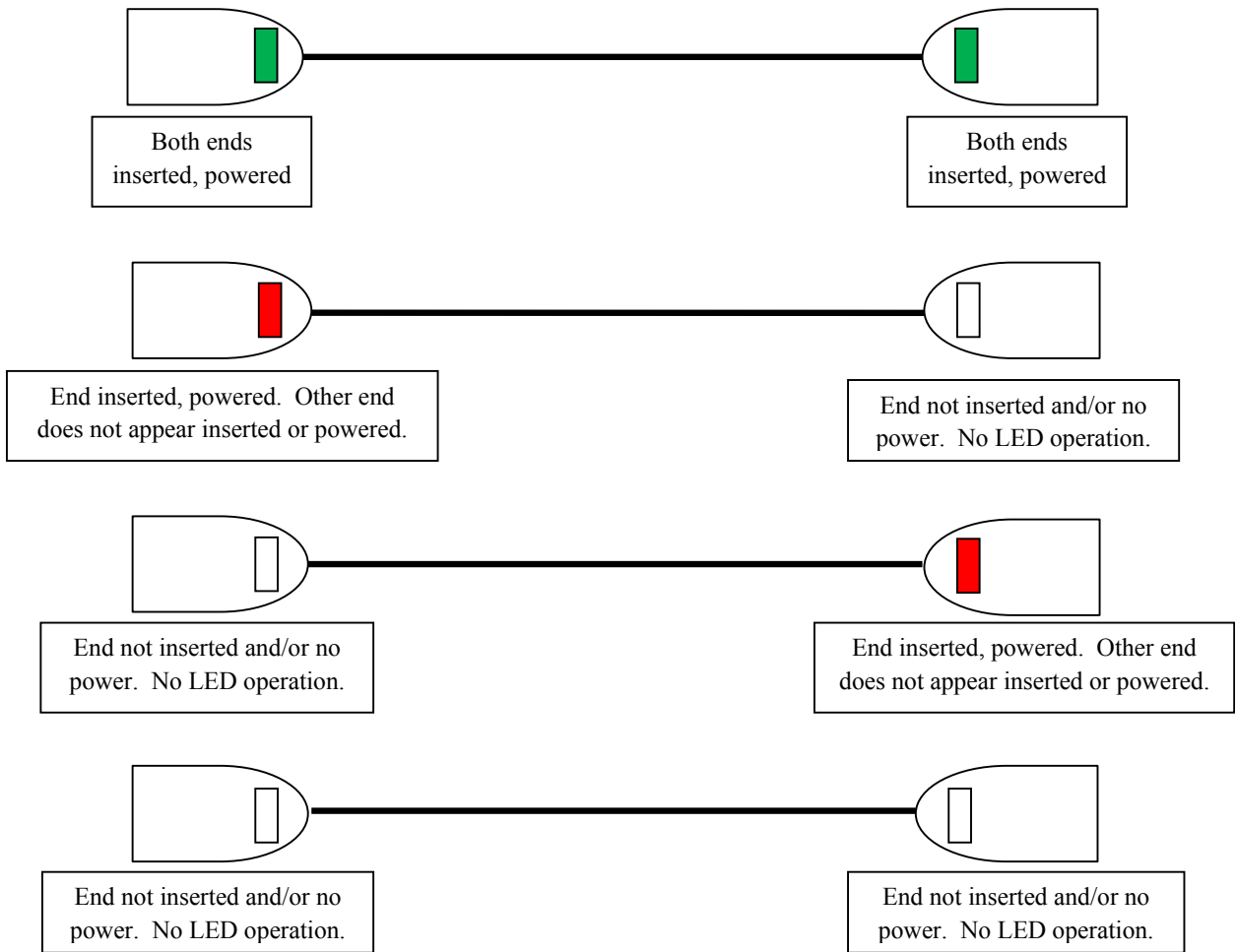

Figure 6. Laserwire LED operation.

The optical Laserwire LEDs are a physical layer indicator and do not indicate actual traffic flow. A green light on both ends signifies that light, not traffic, is being transmitted by the laser in the opposite end. A red light indicates that the laser in the opposite end is not functioning either because it is not inserted and/or not powered. No LED operation signifies that the lasers in both ends are not transmitting light because both ends are either not inserted and/or not powered.

X. Application Note of Recommended Host-Board Connections.

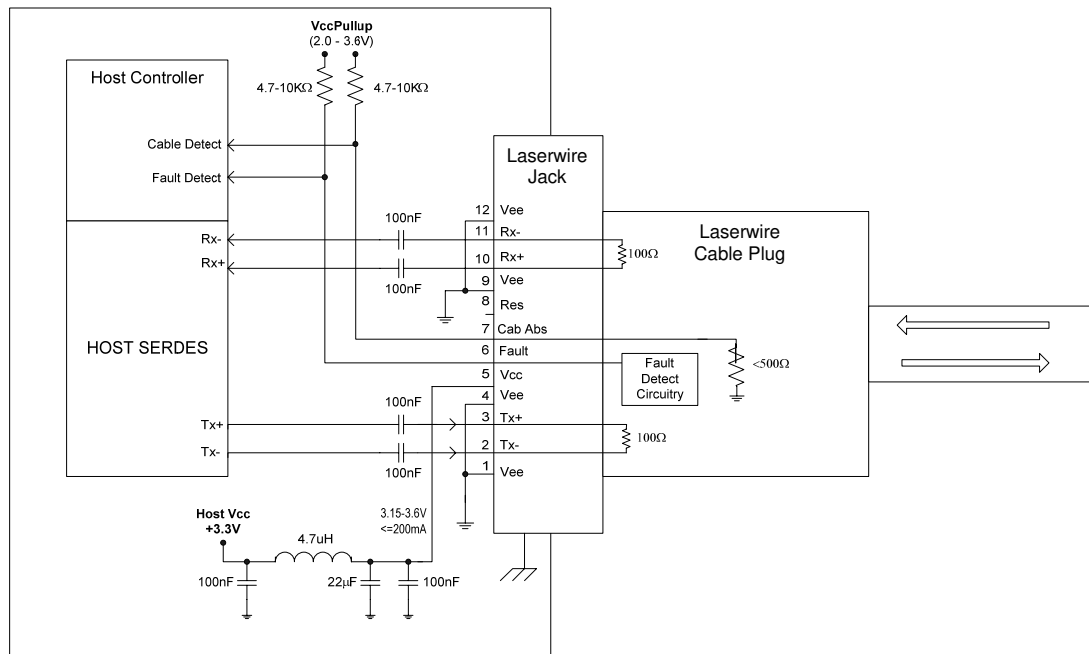

Figure 6. Recommended host board configuration showing power supply filtering, required AC-coupling capacitors, and status pull-up resistors.

X. References

1. SFF-8077i rev 4.5 – XFP Specifications, SFF Committee, August 2005.
2. SFF-8431 rev 4.2 – SFP+ Specifications, SFF Committee, December 2007.
3. IEEE Std 802.3ae, 2002 Edition, IEEE Standards Department, 2002.
4. IEEE Std 802.3, 2002 Edition, IEEE Standards Department, 2002.
5. “Fibre Channel Physical and Signaling Interface (FC-PH, FC-PH2, FC-PH3)”. American National Standard for Information Systems.
6. “Fibre Channel Physical Interface Specification (FC-PI-4 Rev. 6.1)”. American National Standard for Information Systems.

XI. For More Information

Finisar Corporation
 1389 Moffett Park Drive
 Sunnyvale, CA 94089-1133
 Tel. 1-408-548-1000
 Fax 1-408-541-6138
sales@finisar.com
www.finisar.com