



Chipsmall Limited consists of a professional team with an average of over 10 year of expertise in the distribution of electronic components. Based in Hongkong, we have already established firm and mutual-benefit business relationships with customers from,Europe,America and south Asia,supplying obsolete and hard-to-find components to meet their specific needs.

With the principle of “Quality Parts,Customers Priority,Honest Operation,and Considerate Service”,our business mainly focus on the distribution of electronic components. Line cards we deal with include Microchip,ALPS,ROHM,Xilinx,Pulse,ON,Everlight and Freescale. Main products comprise IC,Modules,Potentiometer,IC Socket,Relay,Connector.Our parts cover such applications as commercial,industrial, and automotives areas.

We are looking forward to setting up business relationship with you and hope to provide you with the best service and solution. Let us make a better world for our industry!



Contact us

Tel: +86-755-8981 8866 Fax: +86-755-8427 6832

Email & Skype: info@chipsmall.com Web: www.chipsmall.com

Address: A1208, Overseas Decoration Building, #122 Zhenhua RD., Futian, Shenzhen, China



IRIS-M

~25° medium beam with sublens and holder
optimized for CREE XM-L

TECHNICAL SPECIFICATIONS:

Dimensions	Ø 38 mm
Height	28.8 mm
Fastening	glue, pin, screw
Colour	black
Box size	
Box weight	0 kg
Quantity in Box	360 pcs
ROHS compliant	yes ⓘ



MATERIAL SPECIFICATIONS:

Component	Type	Material	Colour
LEDILSTAR-SUB	Lens	PC	
IRIS	Lens	PMMA	clear
IRIS-XM-HLD	Holder	PC	black

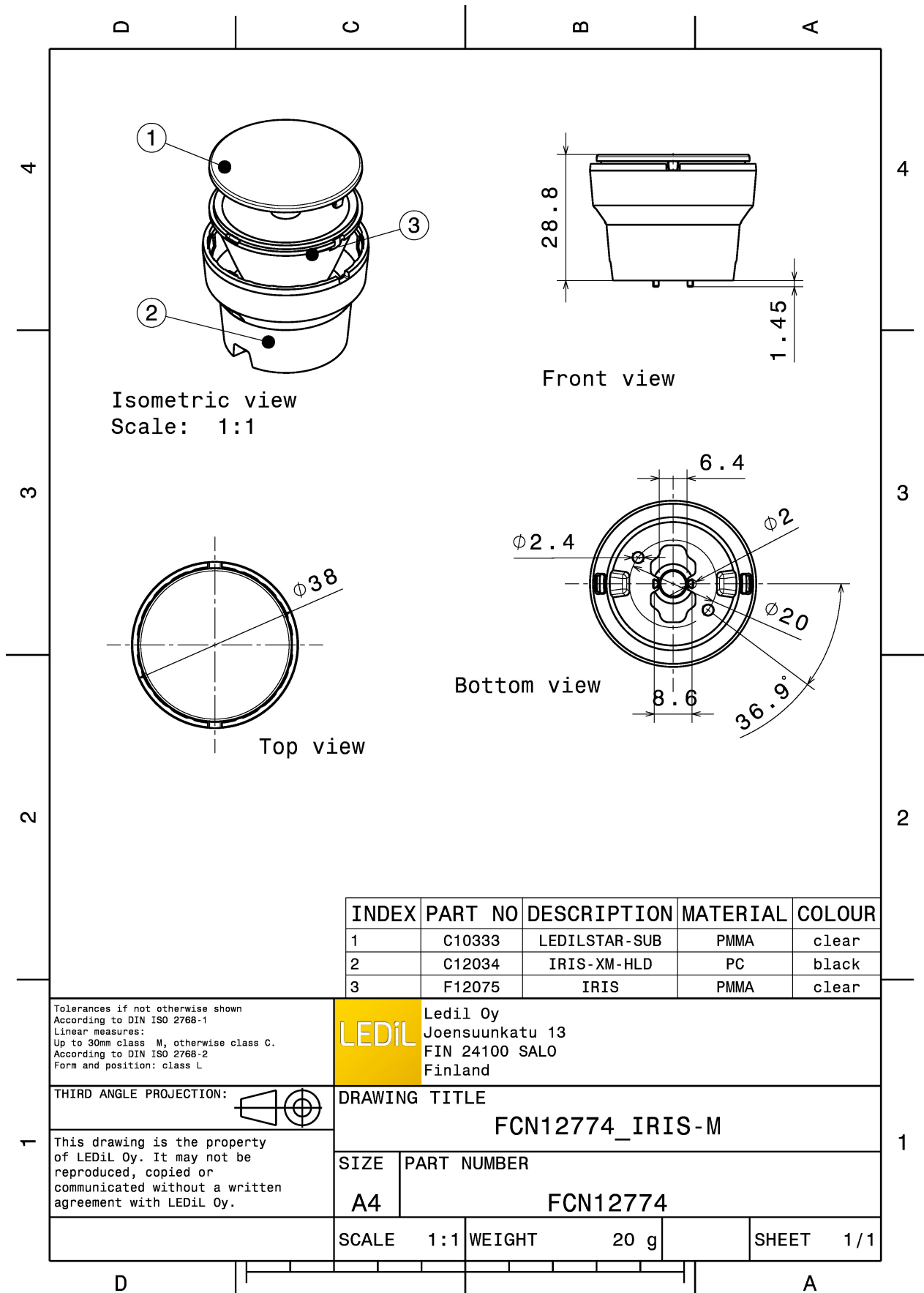

PHOTOMETRIC DATA (MEASURED):



LED XHP50
 FWHM 28.0°
 Efficiency 84 %
 Peak intensity 2.800 cd/lm
 Required components:

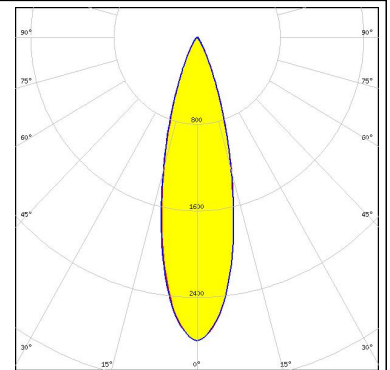
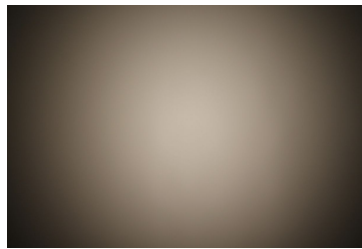

LED XM-L
 FWHM 28.0°
 Efficiency 84 %
 Peak intensity 1.400 cd/lm
 Required components:

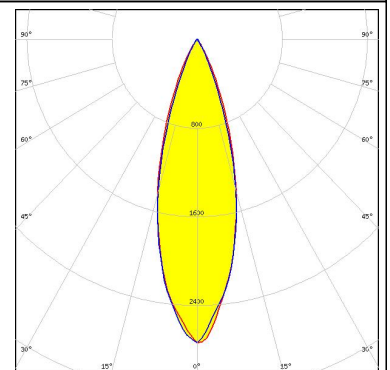
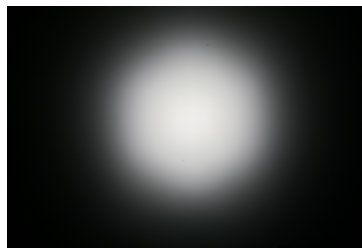

LED XM-L2
 FWHM 29.0°
 Efficiency 80 %
 Peak intensity 2.900 cd/lm
 Required components:

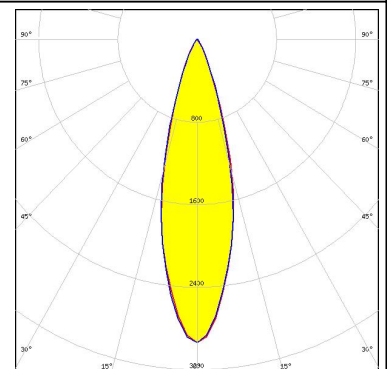
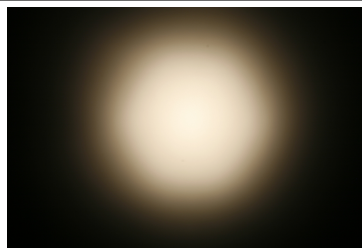

LED LUXEON V
 FWHM 28.0°
 Efficiency 84 %
 Peak intensity 3.200 cd/lm
 Required components:

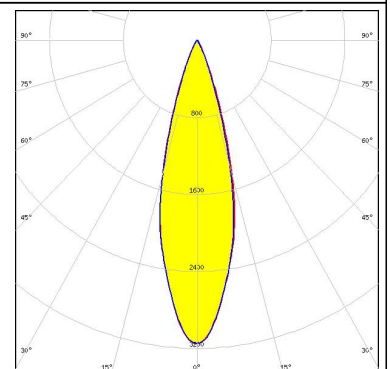
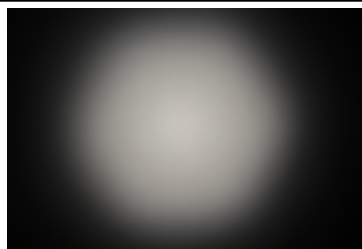

PHOTOMETRIC DATA (SIMULATED):



LED XHP35 HD
FWHM 32.0°
Efficiency 87 %
Peak intensity 2.490 cd/lm
Required components:

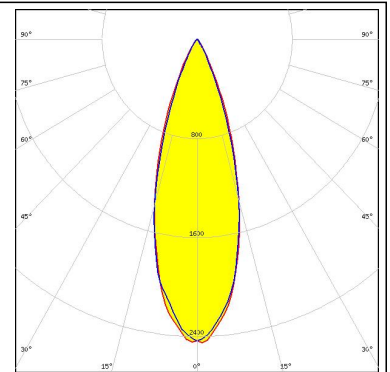

LED XHP50.2
FWHM 32.0°
Efficiency 83 %
Peak intensity 2.230 cd/lm
Required components:

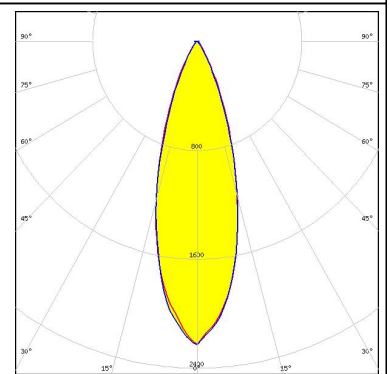

GENERAL INFORMATION:

NOTE: The typical beam angle will be changed by different color, chip size and chip position tolerance. The typical total beam angle is the full angle measured where the luminous intensity is half of the peak value.

MATERIALS:

As part of our continuous research and improvement processes, and to ensure the best possible quality and availability of our products, LEDiL reserves the right to change material grades without notice.

PRODUCT DATA USER AGREEMENT AND DISCLAIMER:

The measured data in the provided downloadable LEDiL Product Datasheets and Mechanical 2D-Drawings is rounded and provided as reference for planning. LEDiL Oy's optical specifications have been verified by conducting performance testing of the products in accordance with the company's quality system. The reported data are averaged results of multiple measurements with typical variation. LEDiL Oy reserves the right to without prior notification make changes and improvements to its products.

LEDiL Oy assumes neither warranty, nor guarantee nor any other liability of any kind for the contents and correctness of the provided data. The provided data has been generated with highest diligence but the provided data may in reality not represent the complete possible variation range of all intrinsic parameters. Therefore, in certain cases a deviation from the provided data could occur.

LEDiL Oy reserves the right to undertake technical changes of its products without further notification which could lead to changes in the provided data. LEDiL Oy assumes no liability of any kind for the possible deviation from any provided data or any other damage resulting from the usage of the provided data.

The user agrees to this disclaimer and user agreement with the download or usage of the provided files.

LEDiL Oy

Joensuunkatu 13
FI-24240 SALO
Finland

LEDiL Inc.

228 West Page Street
Suite D
Sycamore IL 60178
USA

Local sales and technical support

[www.ledil.com/
where_to_buy](http://www.ledil.com/where_to_buy)

Shipping locations

Salo, Finland
Hong Kong, China

Distribution Partners

[www.ledil.com/
where_to_buy](http://www.ledil.com/where_to_buy)