



Chipsmall Limited consists of a professional team with an average of over 10 year of expertise in the distribution of electronic components. Based in Hongkong, we have already established firm and mutual-benefit business relationships with customers from,Europe,America and south Asia,supplying obsolete and hard-to-find components to meet their specific needs.

With the principle of “Quality Parts,Customers Priority,Honest Operation,and Considerate Service”,our business mainly focus on the distribution of electronic components. Line cards we deal with include Microchip,ALPS,ROHM,Xilinx,Pulse,ON,Everlight and Freescale. Main products comprise IC,Modules,Potentiometer,IC Socket,Relay,Connector.Our parts cover such applications as commercial,industrial, and automotives areas.

We are looking forward to setting up business relationship with you and hope to provide you with the best service and solution. Let us make a better world for our industry!



Contact us

Tel: +86-755-8981 8866 Fax: +86-755-8427 6832

Email & Skype: info@chipsmall.com Web: www.chipsmall.com

Address: A1208, Overseas Decoration Building, #122 Zhenhua RD., Futian, Shenzhen, China



DETAILS

Product Number	FCN13694_ANGELINA-S
Family	ANGELINA
Type	RefPack
Color	metal
Diameter	82 mm
Height	36,04 mm
Style	round
Optic Material	
Holder Material	
Fastening	screw
Status	production ready
ROHS Compliant	Yes
Date Updated	3/11/2016



OPTICAL PROPERTIES

LED	Viewing Angle	Light Beam	Efficiency	cd/lm	Connector
VERO13	20 deg	Spot	93 %	3.000	LEDiL: LEDiL
VERO18	25 deg	Spot	92 %	2.200	LEDiL: LEDiL
V15 Gen6	23 deg	Spot	88 %	2.400	Bender Wirth: 456 Typ L2
V10 Gen7	sim: 17	Spot	sim: 94 %	sim: 4.340	Bender Wirth: 434 Typ L1
CLL03x/CLU03x	21 deg	Spot	92 %	2.300	Bender Wirth: 433 Typ L1
CLU700/701	14 deg	Spot	93 %	3.700	Bender Wirth: 434 Typ L1
CLL02x/CLU02x (LES10)	17 deg	Spot	93 %	2.900	Bender Wirth: 434 Typ L1
CLU720/721	18 deg	Spot	92 %	2.700	-
CXA/B 1816 & CXA/B 1820 & CXA 1850	19 deg	Spot	93 %	2.500	Bender Wirth: 437 Typ L1
CXA/B 15xx	15 deg	Spot	93 %	3.300	Bender Wirth: 441 Typ L1
LUXEON CoB 1202/1203	18 deg	Spot	93 %	2.800	Bender Wirth: 438 Typ L1
CXM-14	sim: 21	Spot	sim: 92 %	sim: 2.300	Bender Wirth: 433 Typ L1
CXM-9	sim: 17	Spot	sim: 93 %	sim: 2.900	Bender Wirth: 434 Typ L1
COB J-Type	22 deg	Spot	93 %	2.300	Bender Wirth: 463 Typ L2
COB L-Type (LES 11)	18 deg	Spot	93 %	2.800	Bender Wirth: 438 Typ L1
Solerialq P9	17 deg	Spot	94 %	3.100	Bender Wirth: 461 Typ L1
Solerialq P13	20 deg	Spot	94 %	2.400	Bender Wirth: 437 Typ L1
Solerialq S13	20 deg	Spot	92 %	2.400	Bender Wirth: 437 Typ L1
LC026B/LC040B	25 deg	Spot	92 %	1.800	Bender Wirth: 450 Typ L2
ZC12/18	sim: 21	Spot	sim: 92 %	sim: 2.300	Bender Wirth: 433 Typ L1
ZC4/6	sim: 17	Spot	sim: 93 %	sim: 2.900	Bender Wirth: 434 Typ L1
SLE G5 LES11	17 deg	Spot	92 %	2.800	Bender Wirth: 434 Typ L1

Relative intensity of FCN13694_ANGELINA-S_(V15)

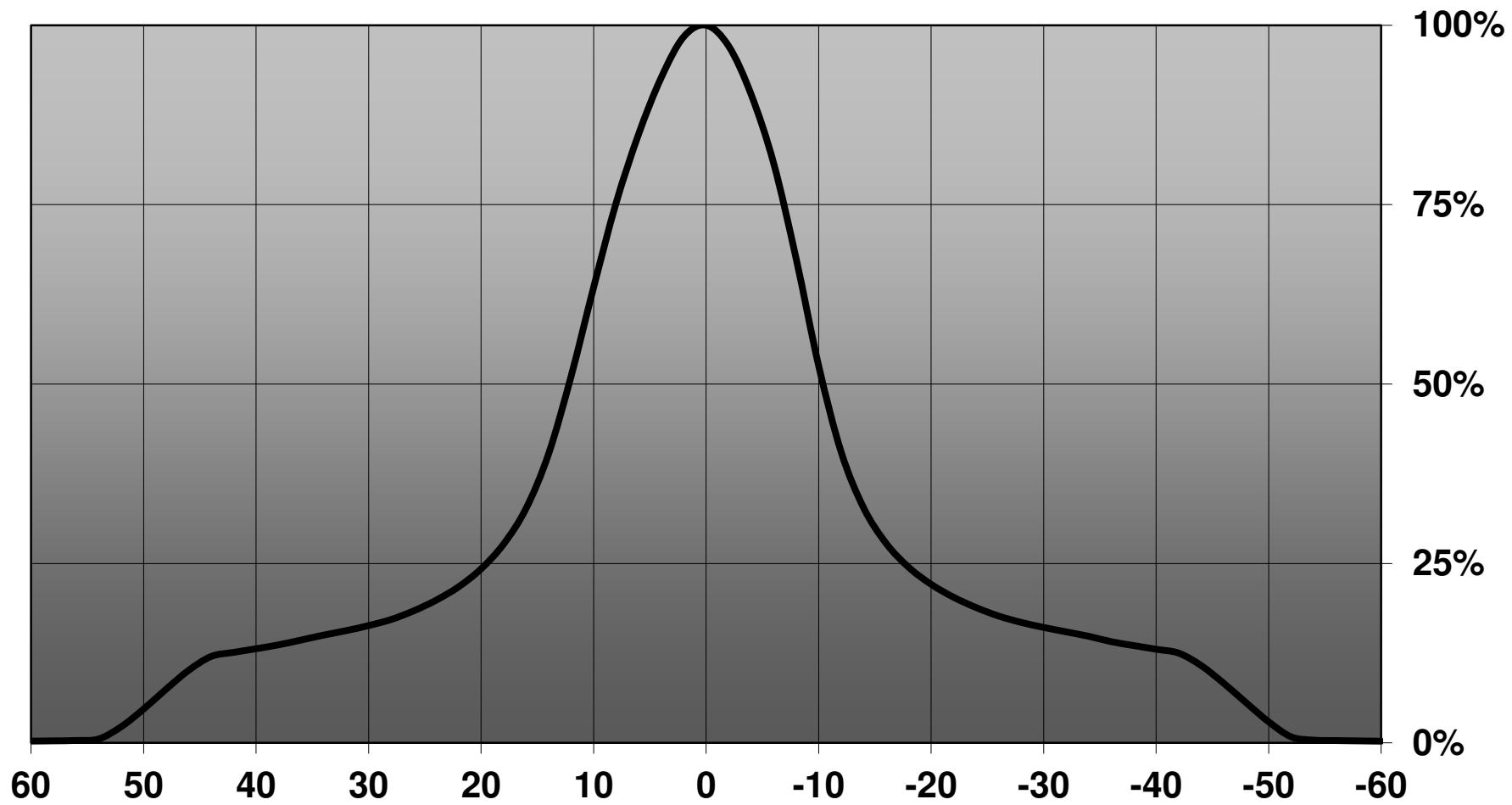

H G F E D C B A

4

3

2

1

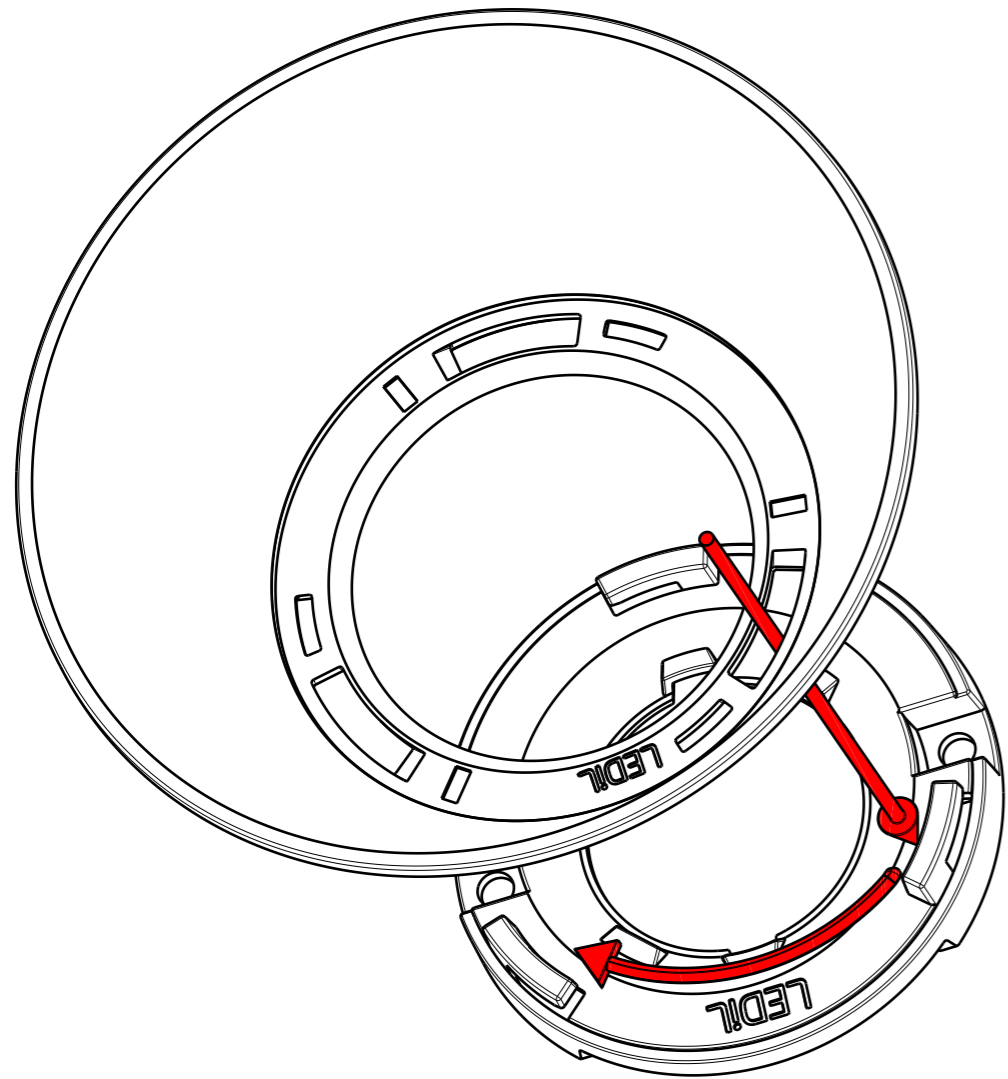

31 + Basepart

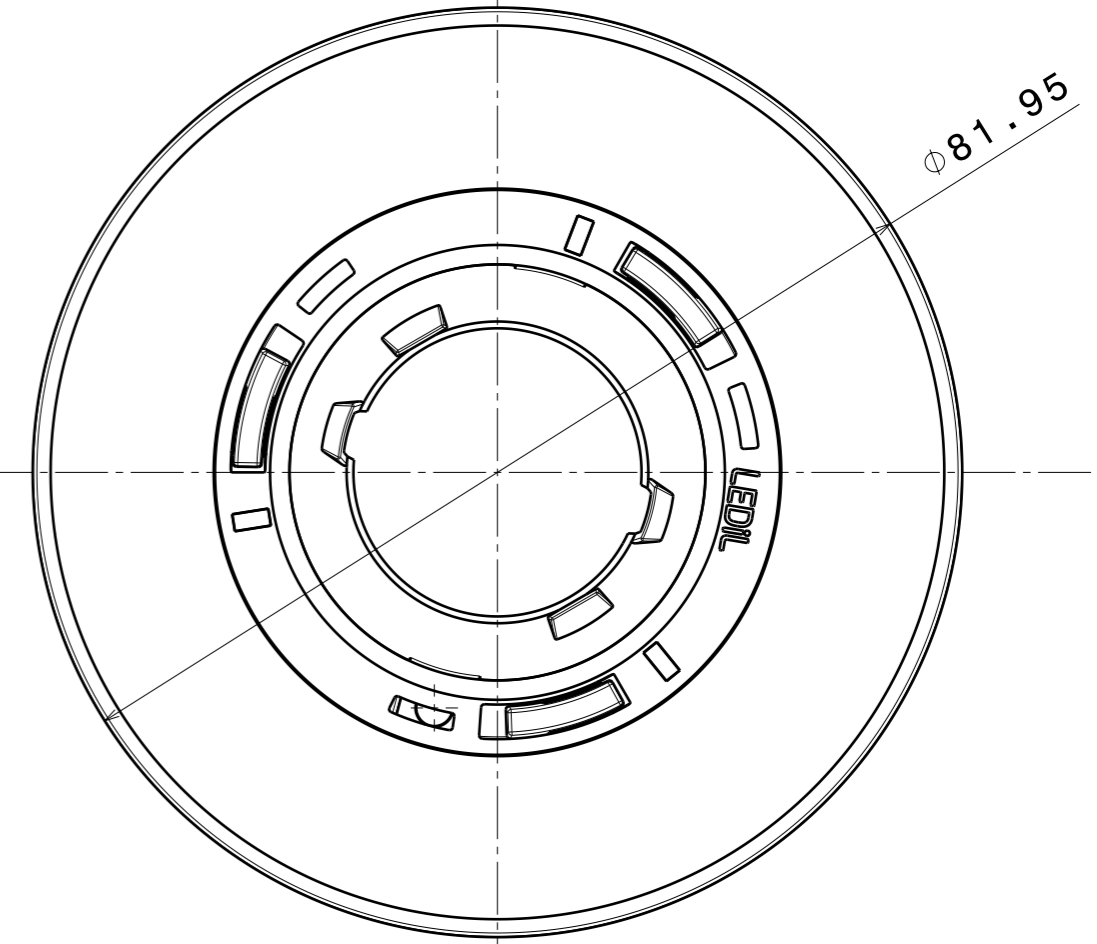
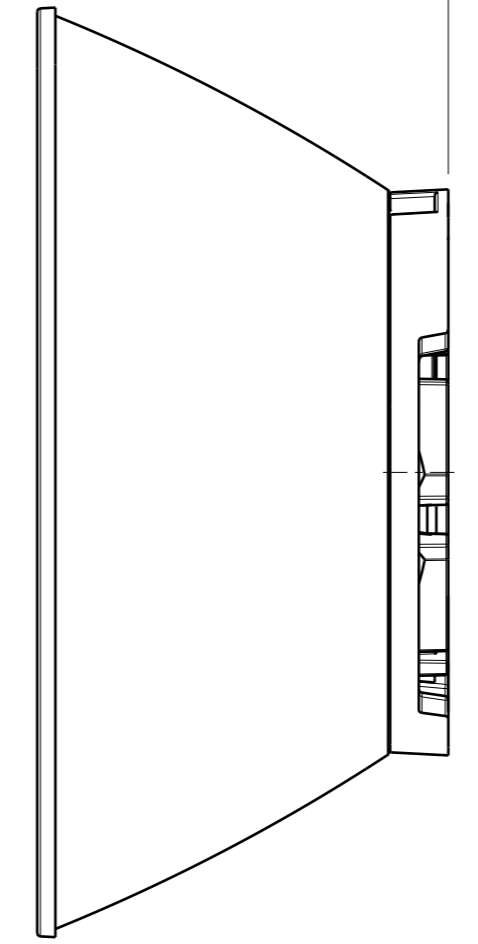

4

3

2

1

H G B A

Tolerances if not otherwise shown
 According to DIN ISO 2768-1
 Linear measures:
 Up to 30mm class M, otherwise class C.
 According to DIN ISO 2768-2
 Form and position: class L

LEDiL LediL Oy
 Salorankatu 10
 FIN 24240 SALO
 Finland

THIRD ANGLE PROJECTION:

DRAWING TITLE
Datasheet_ANGELINA + CLAMP

This drawing is the property of LEDiL Oy. It may not be reproduced, copied or communicated without a written agreement with LEDiL Oy.

SIZE	PART NUMBER		
A3	-		

SCALE	3:2	WEIGHT (g)		SHEET	1/1
-------	-----	------------	--	-------	-----

Luminaire: LEDiL Oy FCN13694_ANGELINA-S_(VERO13)_(VERO13) Eff.93.3%
Lamps: 1 x VERO13_(BXRC-30E2000C) 922.394lm@250mA CCT=3000K P=8 I=250mA

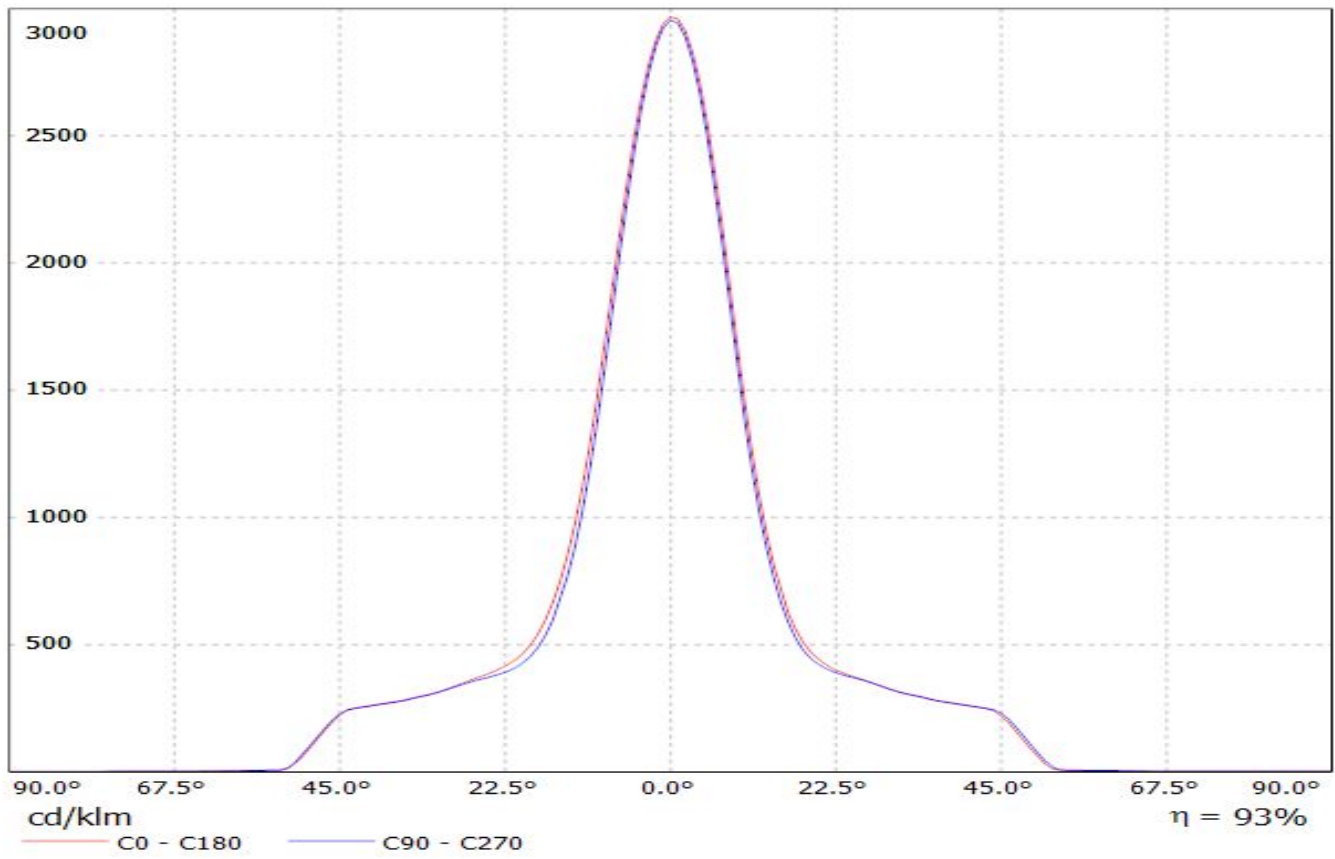

Luminaire: LEDiL Oy FCN13694_ANGELINA-S_(VERO18) Eff.92.2%
Lamps: 1 x VERO18_(BXRC-30E4000F) 906.273lm@250mA CCT=3000K P=7W I=250mA

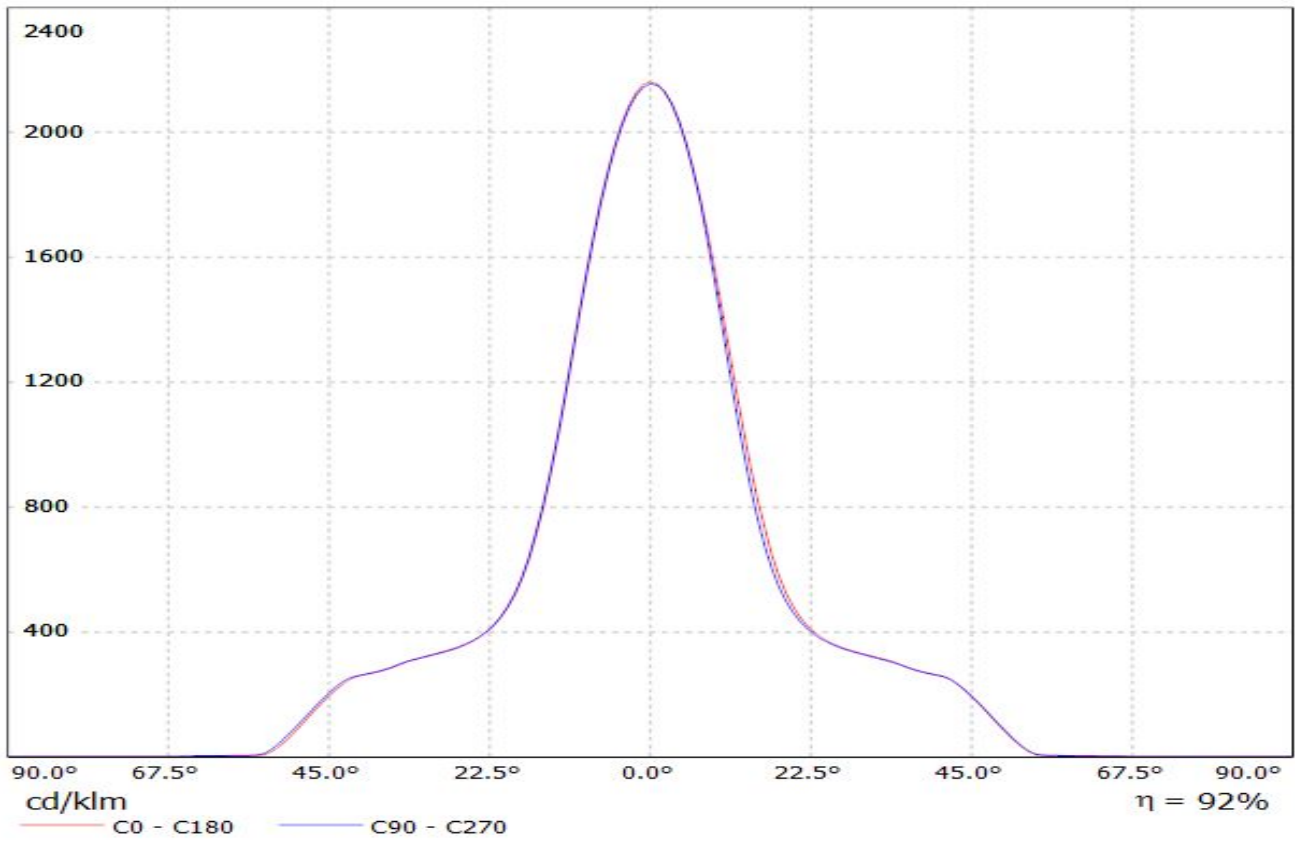

Luminaire: Ledil Oy FCN13694_ANGELINA-S+_B+W_434_TypL1_BRIDGELUX_V10_Gen7_SIMULATED
Lamps: 1 x BRIDGELUX V10 Gen7

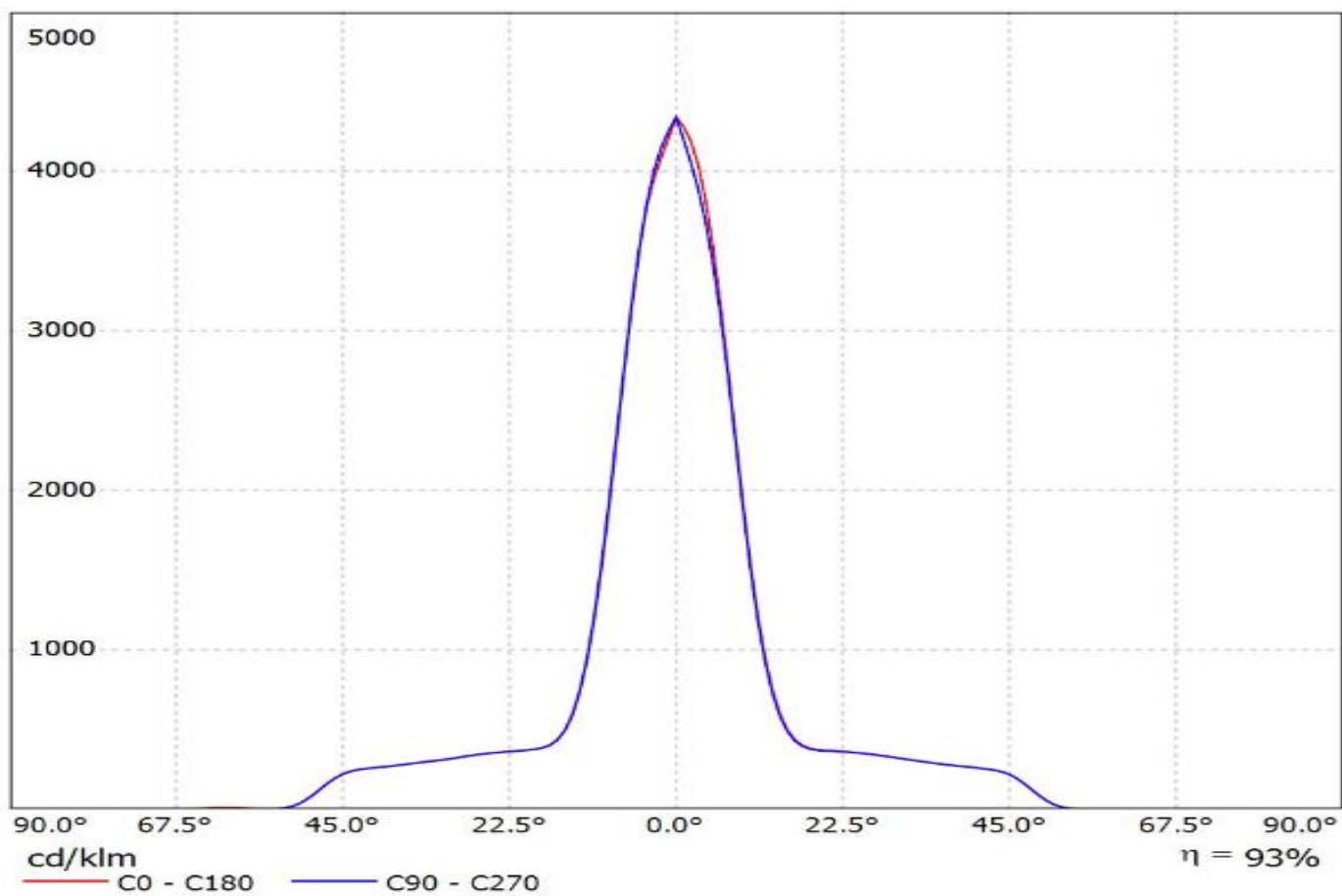

Luminaire: Ledil FCN13694_ANGELINA-S_(CLU034)_(433_Typ_L1)_(C13658) Citizen_CLU034_(CLU034-1205B8-303M1A2)_1180.79lm@250mA_P=8.50075W_l=0.25A
Lamps: 1 x Citizen_CLU034_(433_Typ_L1)_(C13658)_1173.16lm@250mA_P=8.475W_l=0.25A

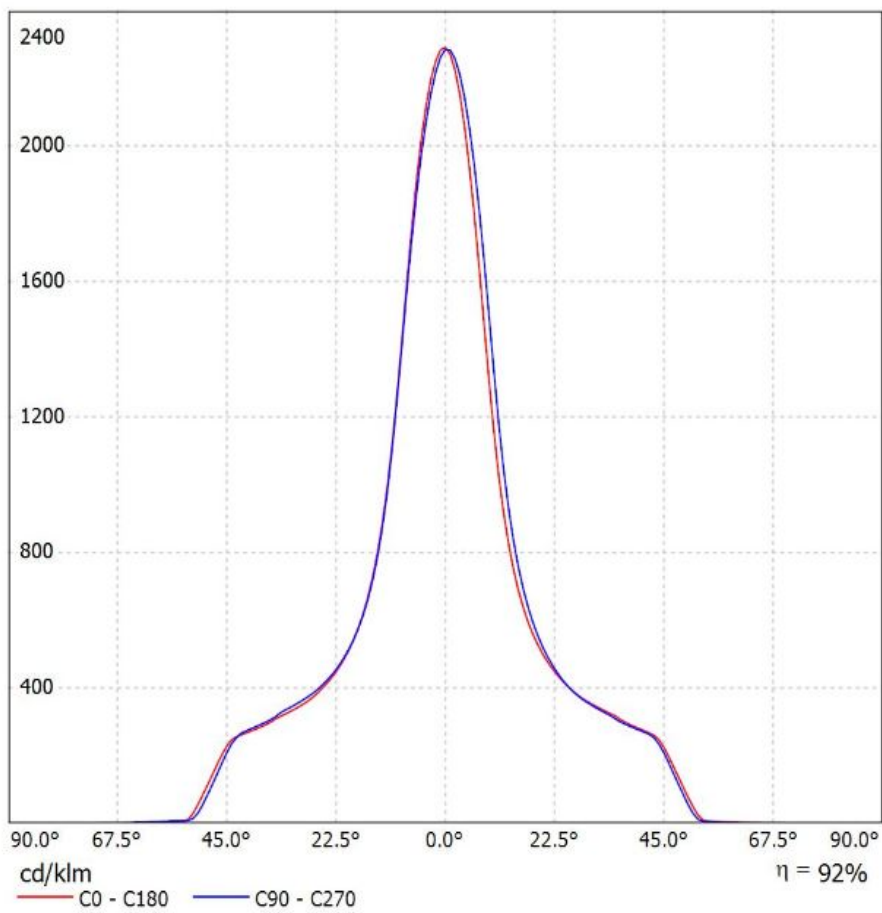

Luminaire: Ledil FCN13694_ANGELINA-S_(CLU700)_ (434_Typ_L1) Citizen_CLU700_(CLU700-1002B8-273M2G1)_390.128lm@100mA_P=3W_I=0.10A
Lamps: 1 x Citizen_CLU700_(CLU700-1002B8-273M2G1)_388.036lm@100mA_P=3W_I=0.10A

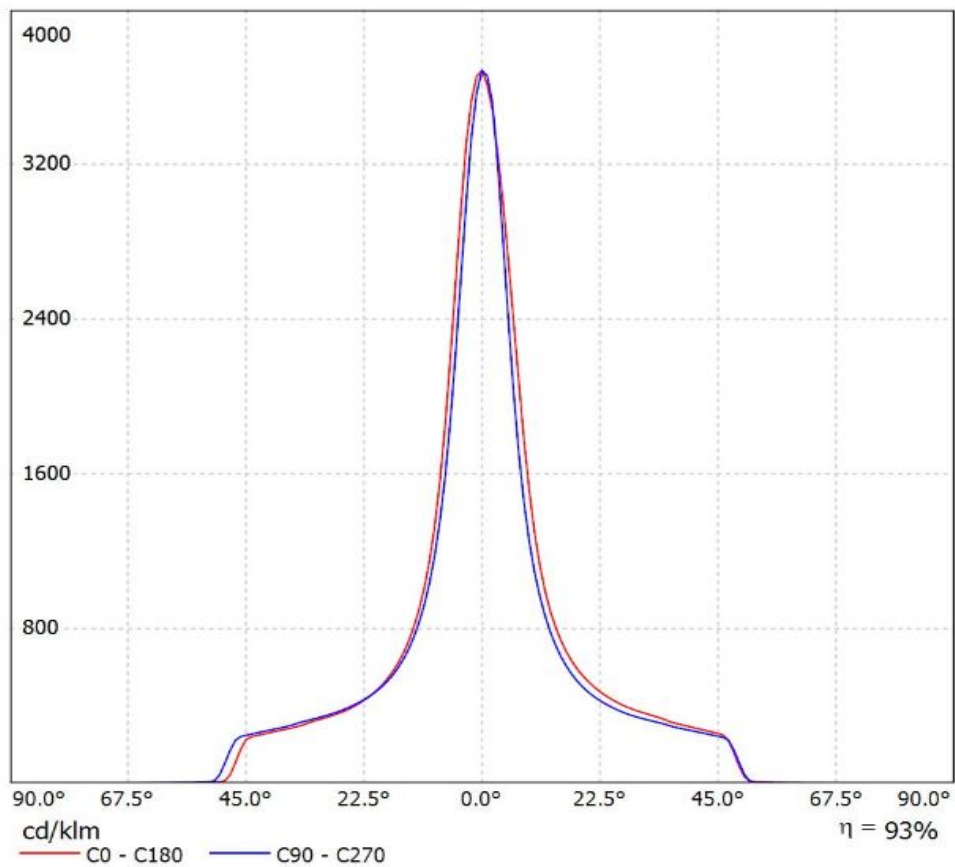

Luminaire: Ledil FCN13694_ANGELINA-S_(CLU024)_ (433_Typ_L1) Citizen_CLU024_(433_Typ_L1)_
(C13658_CLAMP-VERO13-18)_1071.07lm@250mA_P=8.43W_I=0.25A
Lamps: 1 x Citizen_CLU024_(433_Typ_L1)_ (C13658_CLAMP-VERO13-18)
_1071.07lm@250mA_P=8.43W_I=0.25A

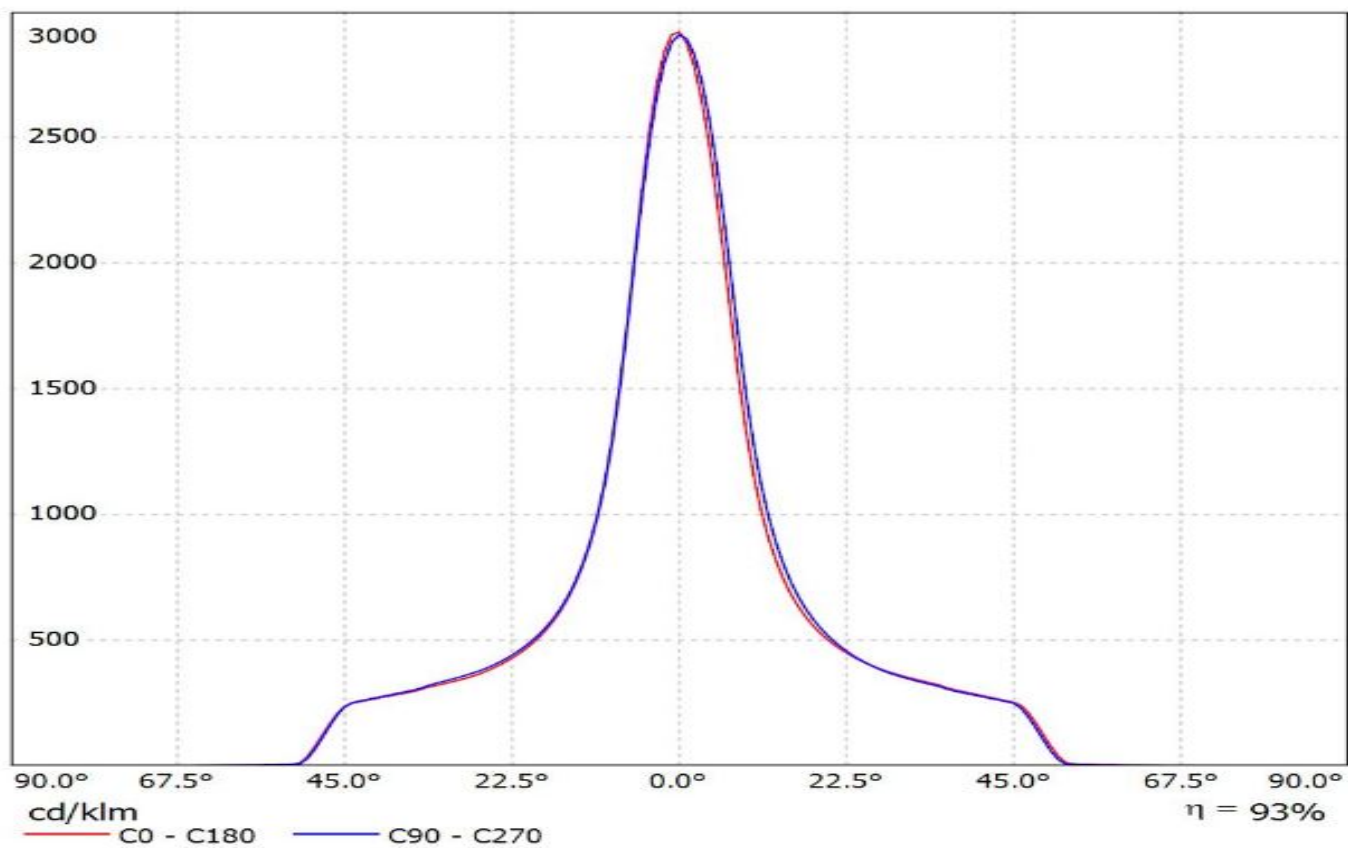

Luminaire: Ledil FCN13694_ANGELINA-S_(CLU720)_ (433_Typ_L1)

Lamps: 1 x Citizen_CLU720_(CLU720-1206B8-273M2G1)_1225.89lm@250mA_P=8.3W_I=0.25A

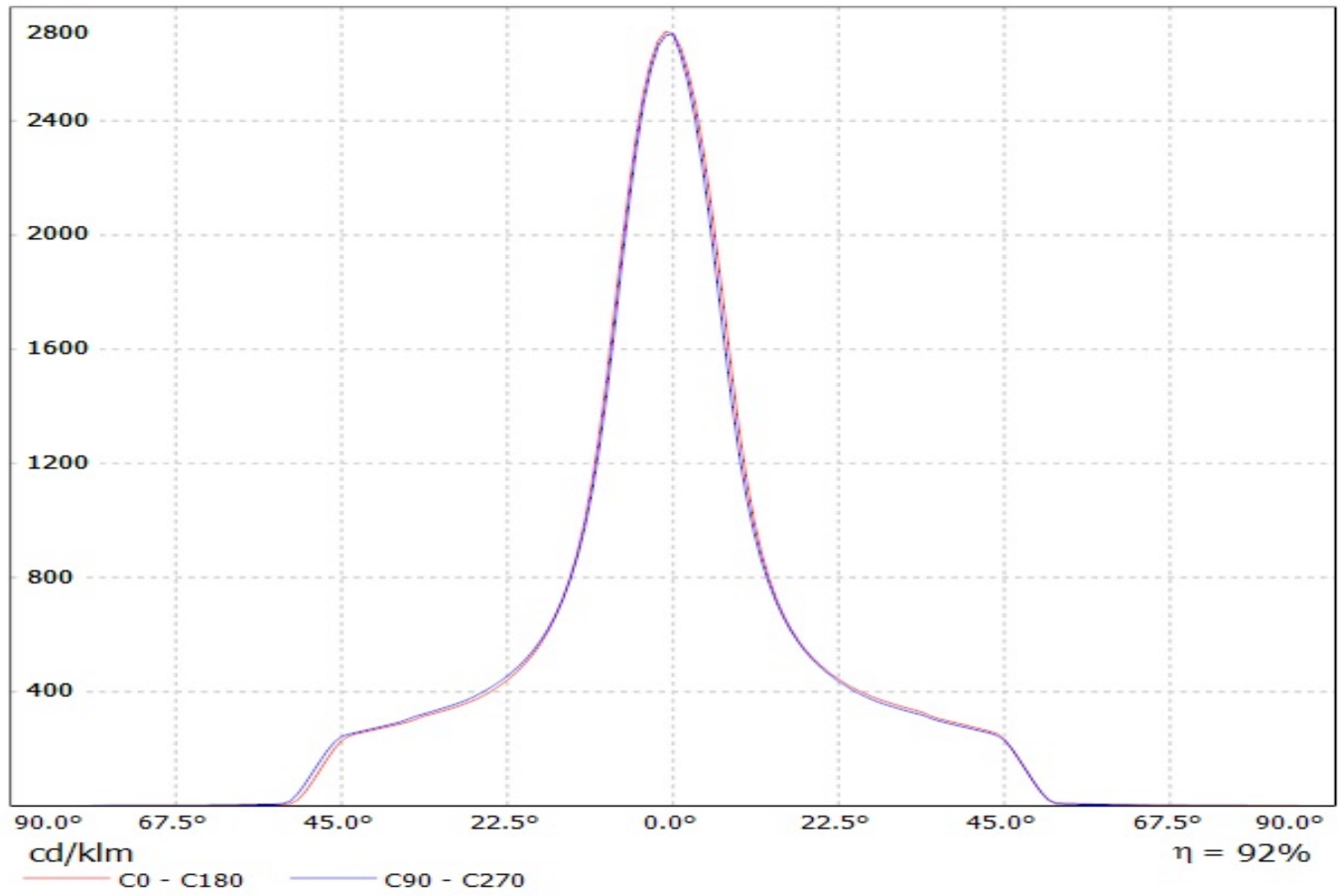

Luminaire: Ledil FCN13694_ANGELINA-S_(CXA1850)

Lamps: 1 x CREE_CXA1850_(CXA1850-30F-T4-N0Y-00001)_831.914lm@250mA_CCT=3000K_P=8.27W_I=0.25A

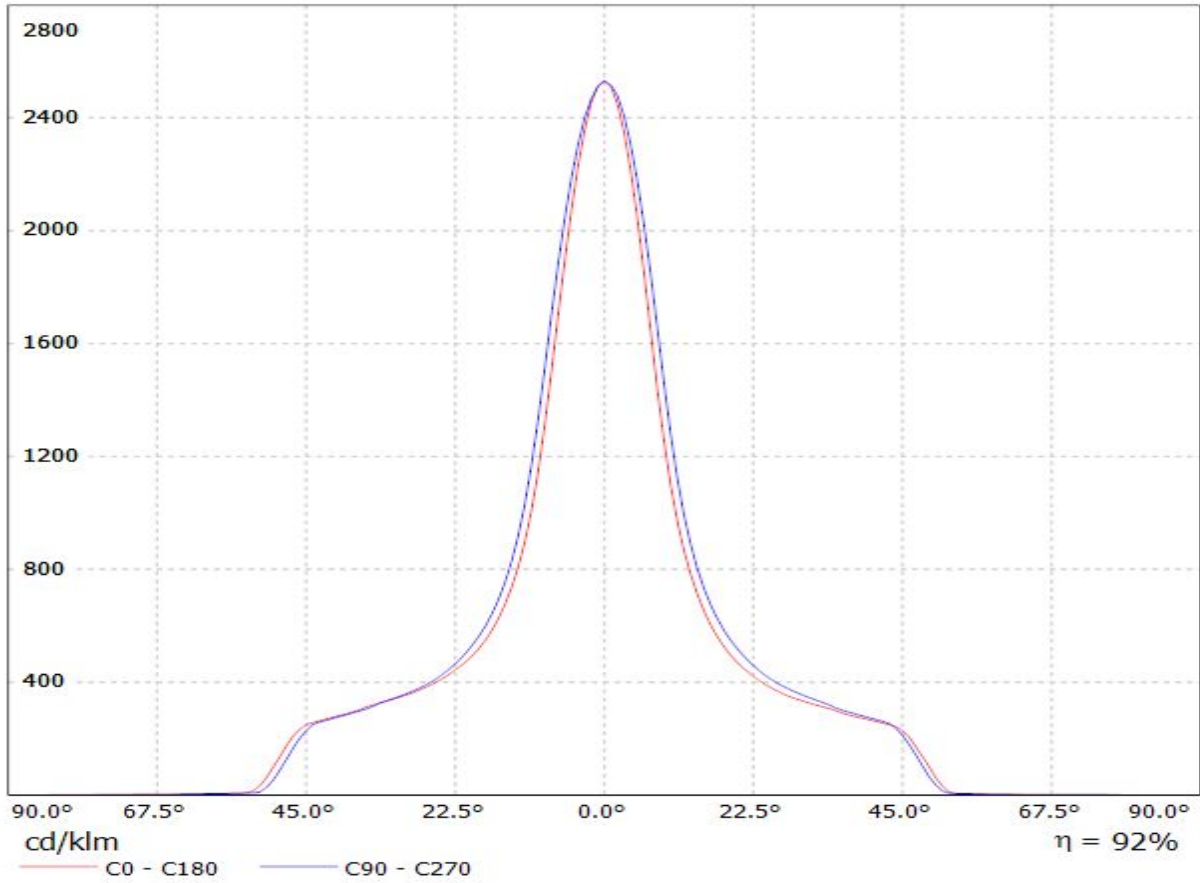

Luminaire: LEDiL Oy FCN13694_ANGELINA-S_(CXA1520)_ (441_Typ_L1)
Lamps: 1 x Cree_CXA1520_(CXA1520-30F-N4-N0H-00001)_993.209lm@250mA_P=8.74575W_I=0.2499A

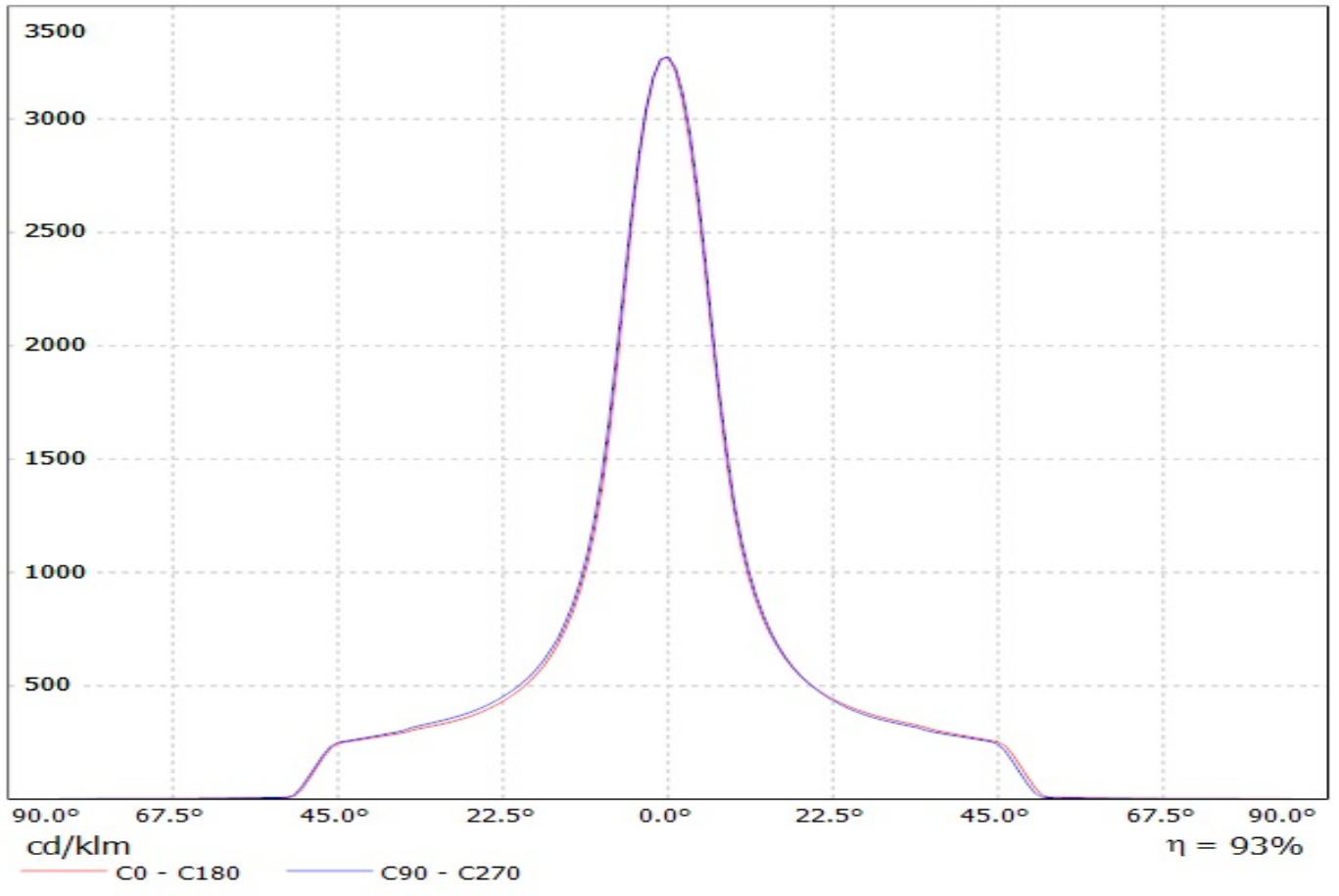

Luminaire: LEDiL Oy FCN13694_ANGELINA-S_(LUXEON_CoB_1203)_ (438_Typ_L1)_ (C13658_CLAMP-VERO13-18)
Lamps: 1 x LUXEON_CoB_1203_(438_Typ_L1)_ (C13658_CLAMP-VERO13-18)_984.561lm@250mA_P=8.6828W_I=0.25A

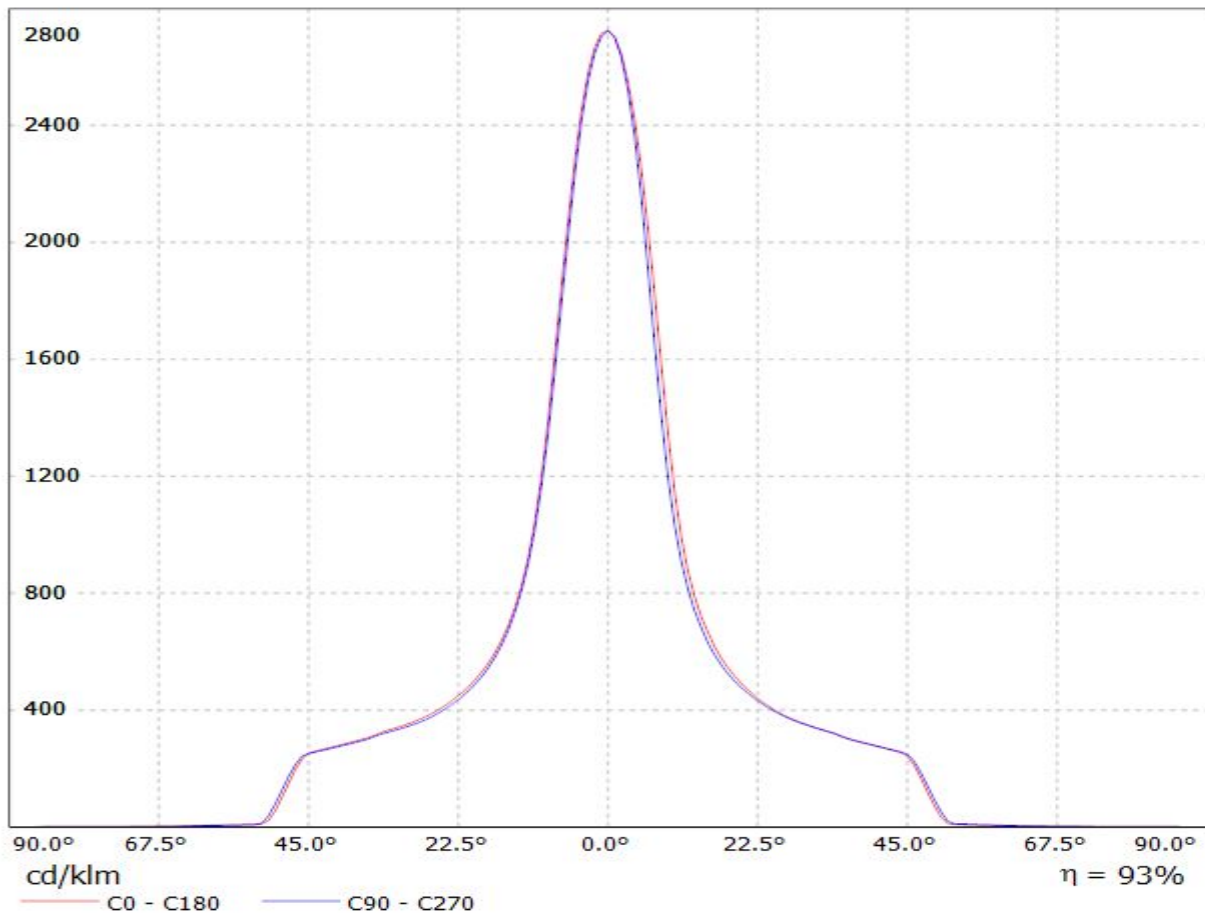

Luminaire: LEDiL Oy FCN13694_ANGELINA-S_(NFDxJ130B)

Lamps: 1 x Nichia_NFDxJ130B_(463 Typ L2)_C13658_CLAMP-VERO13-18_1458.51lm@250mA_P=8.87739W_I=0.2498A

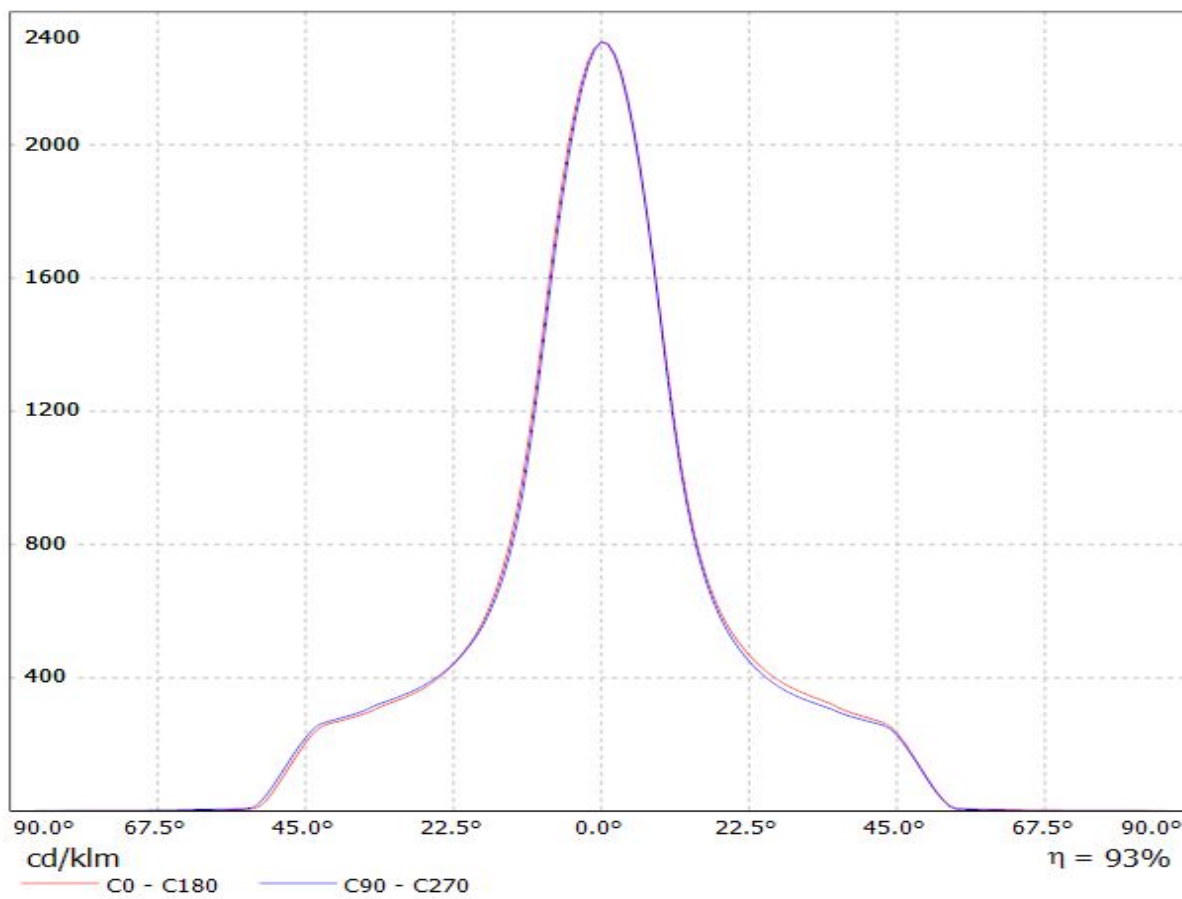

Luminaire: LEDiL Oy FCN13694_ANGELINA-S_(NFCxL060B)_(438_Typ_L1)

Lamps: 1 x Nichia_NFCxL060B_(SM403G2450R8000)_(C13658)_(438_Typ_L1)_1298.52@250mA_P=8.45498W_I=0.2498A

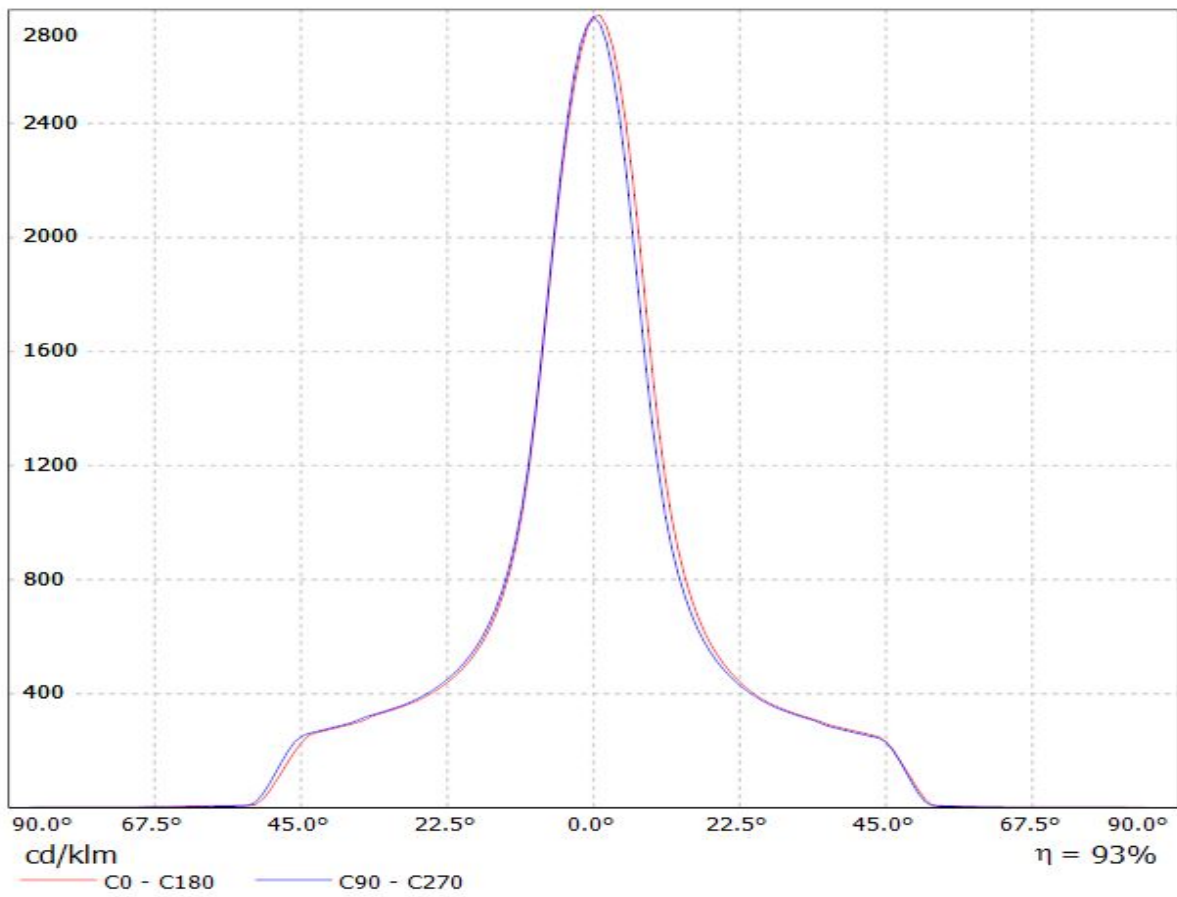

Luminaire: Ledil FCN13694_ANGELINA-S_(Soleriq_P9)

Lamps: 1 x Osram_Soleriq_P9_(GW_MAFJB1.EM)_972.417lm@250mA_CCT=4299K_P=6.9W_I=0.25A

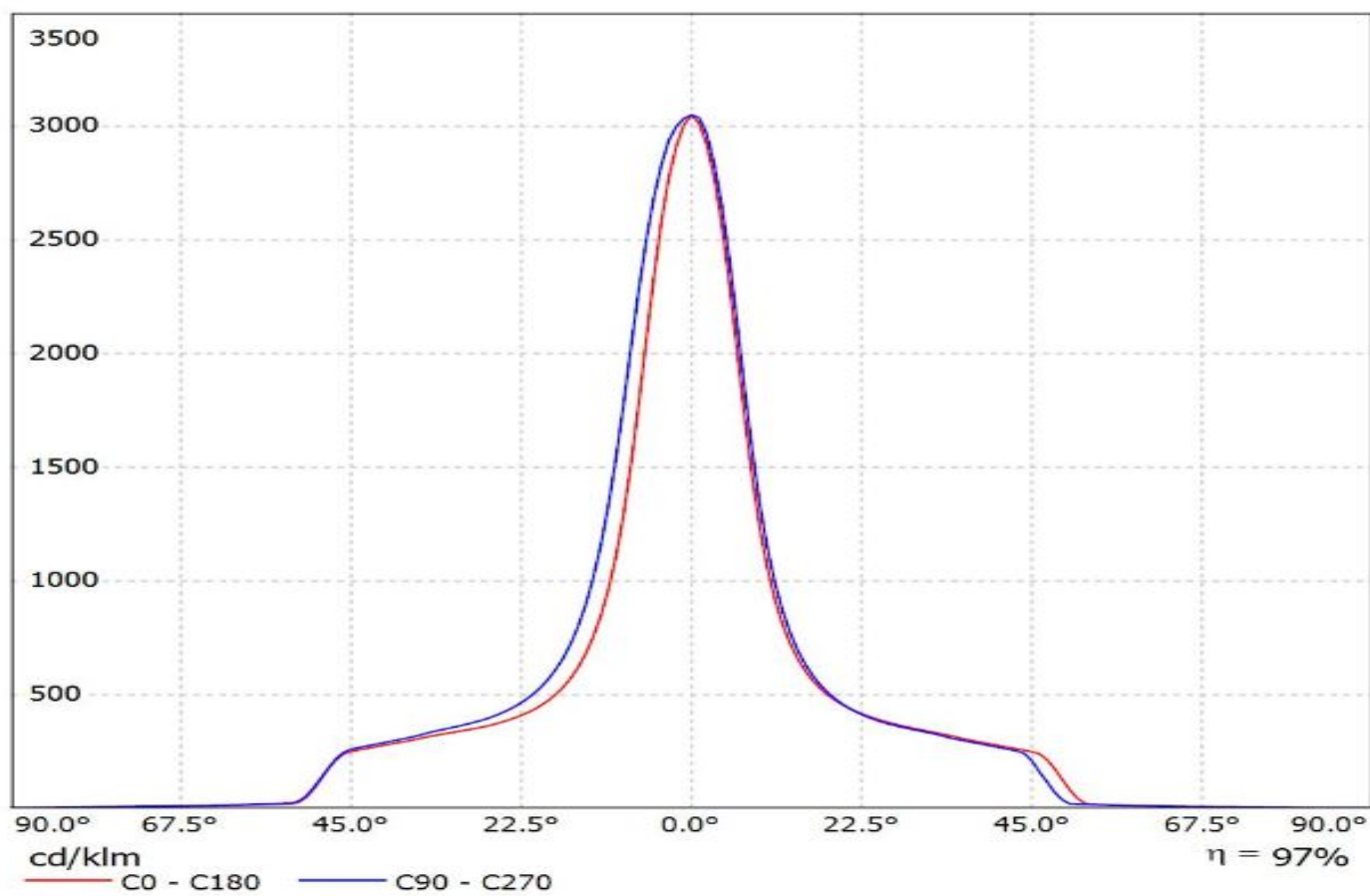

Luminaire: Ledil FCN13694_ANGELINA-S_(Soleriq_P13)

Lamps: 1 x Osman_Soleriq_P13_1009.11lm@250mA_P=6.9385W_I=0.25A

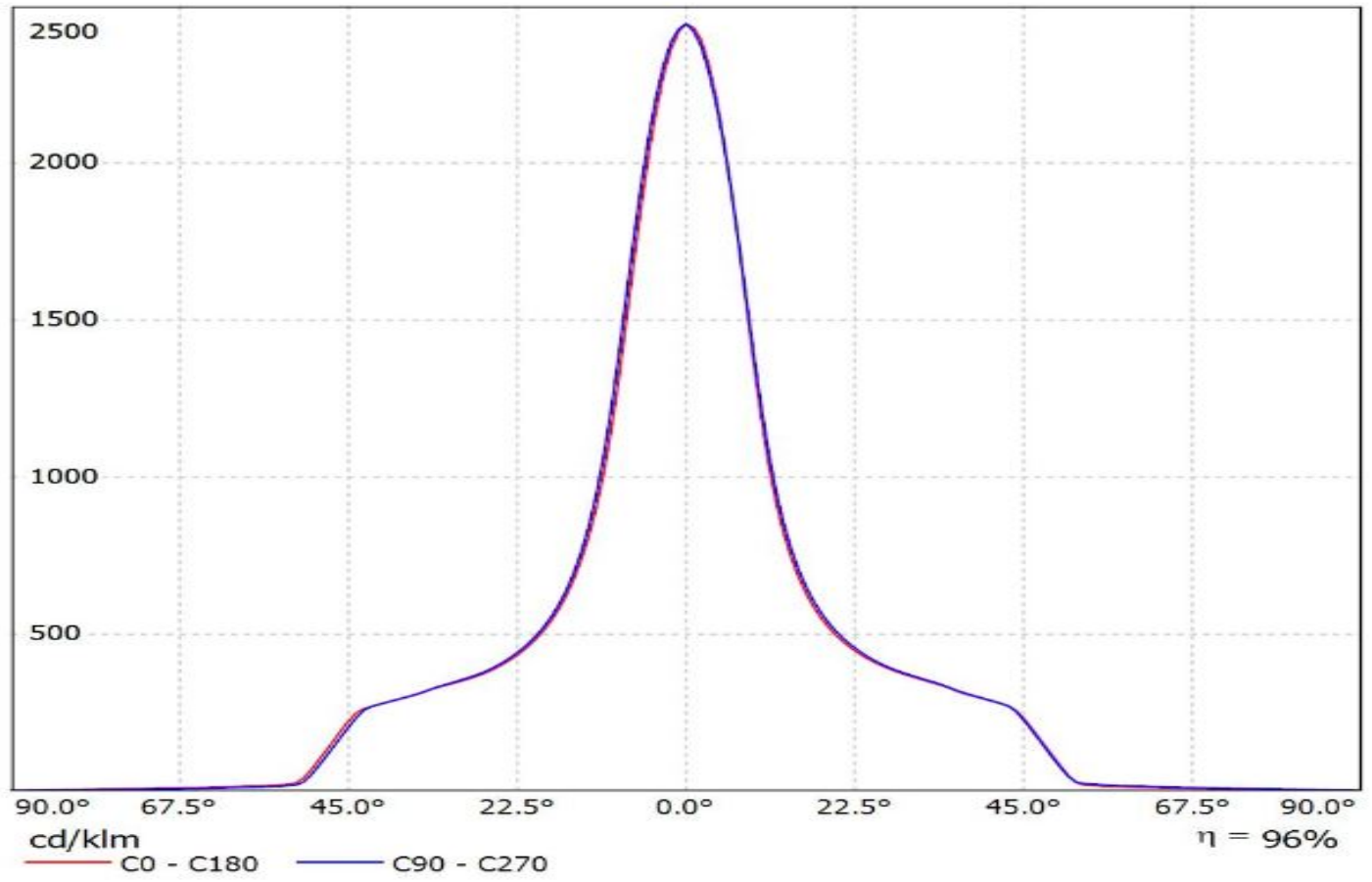

Ledil FCN13694_ANGELINA-S_(Soleriq_S13) / LDC (Linear)

Luminaire: Ledil FCN13694_ANGELINA-S_(Soleriq_S13)

Lamps: 1 x Osram_Soleriq_S13_(GW_KAGHB1.EM)_896.727lm@250mA_P=7.44679W_I=250mA

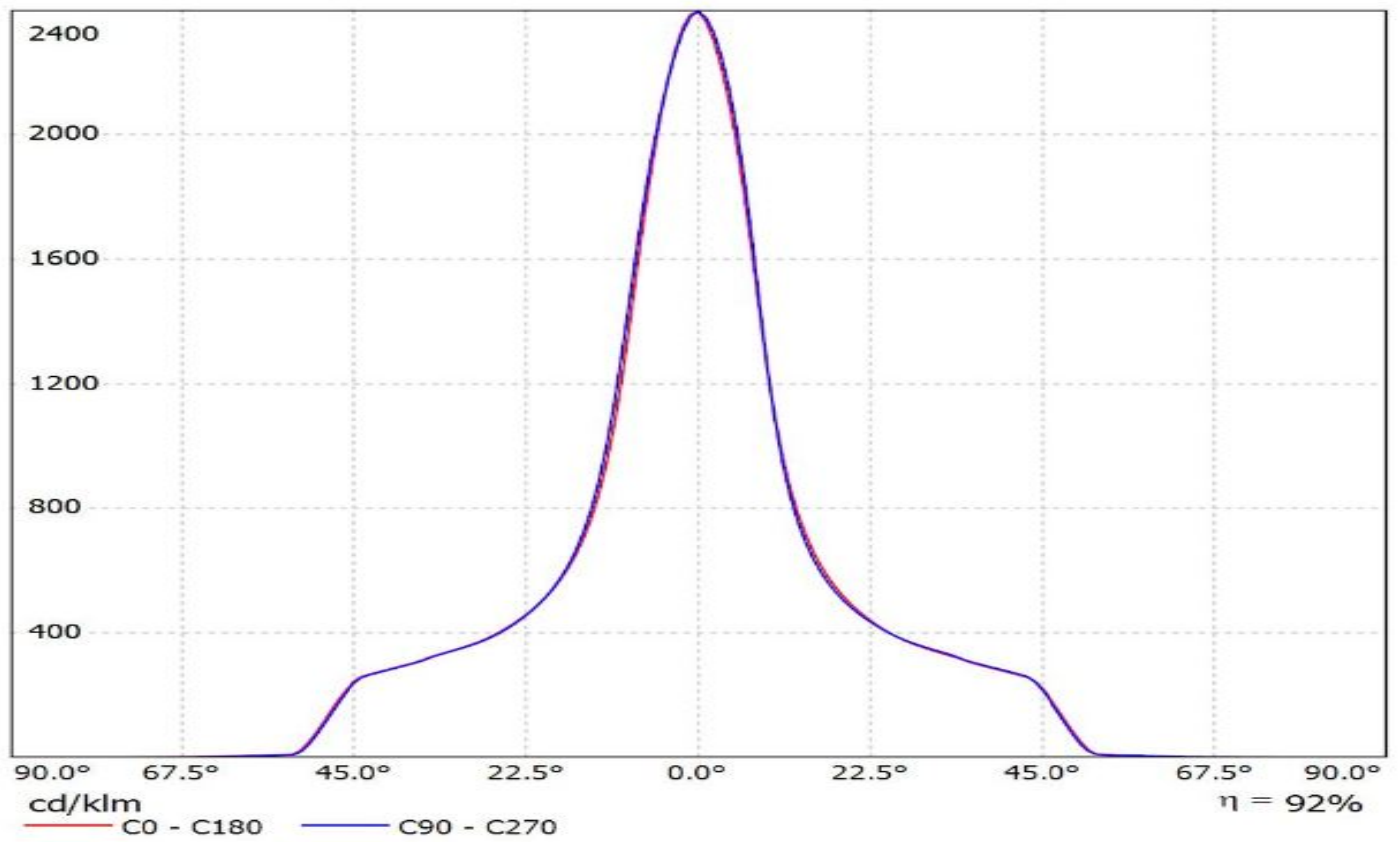

Luminaire: Ledil FCN13694_ANGELINA-S_(450_Typ_L2)_(C13658_CLAMP-VERO13-18)_(LC040B)
Lamps: 1 x Samsung_LC040B_CCT=3000K_(SPHWW1HDNE25010101)_(450_Typ_L2)_(C13658_CLAMP-VERO13-18)_1109.31lm@250mA_P=8.2W_I=0.25A

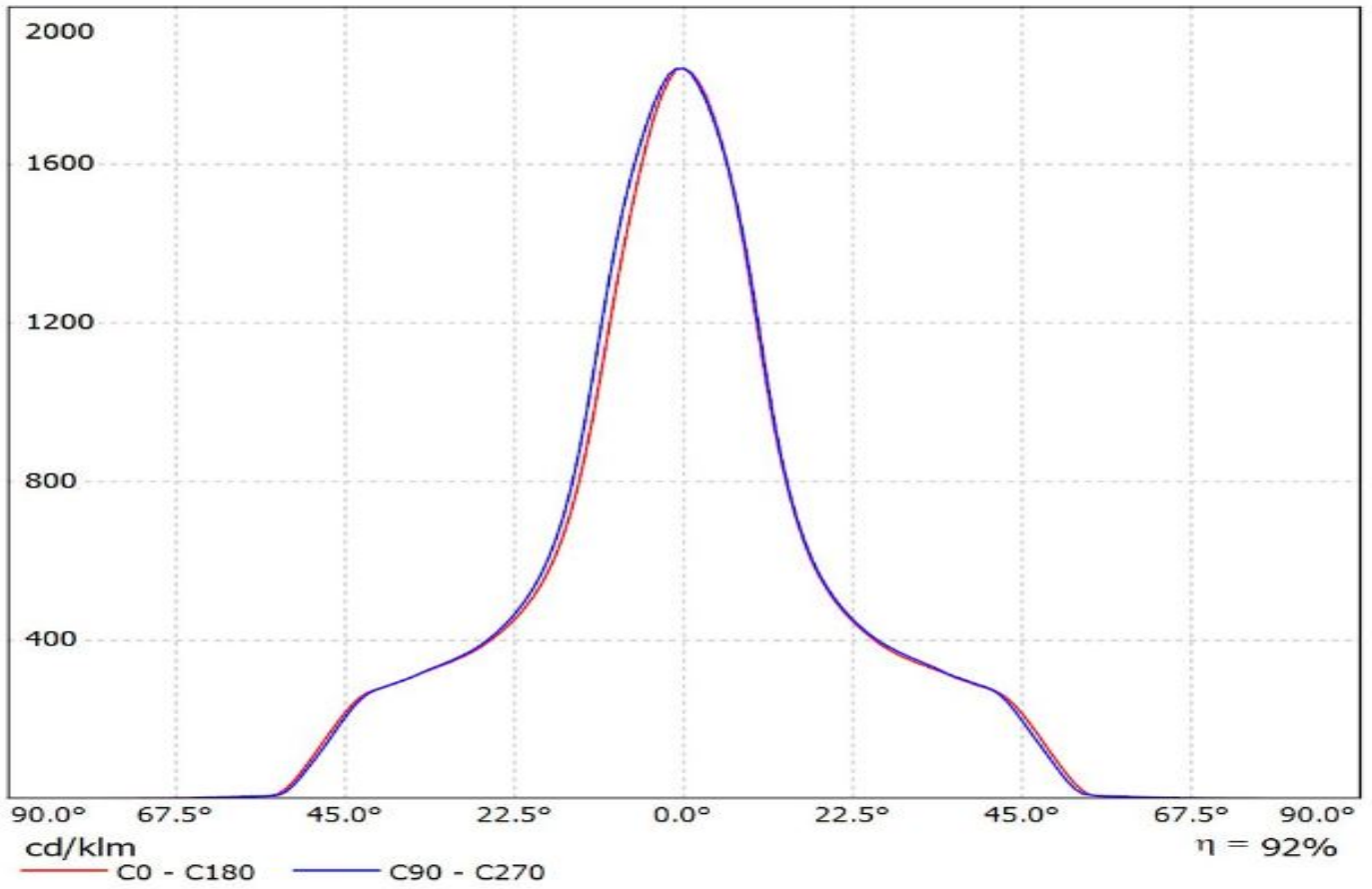

Luminaire: LEDiL Oy FCN13694_ANGELINA-S_(SLE-G5_LES-11)
Lamps: 1 x Tridonic_SLE-G5_LES-11_1137.55lm@250mA_P=8.4177W_I=0.250A

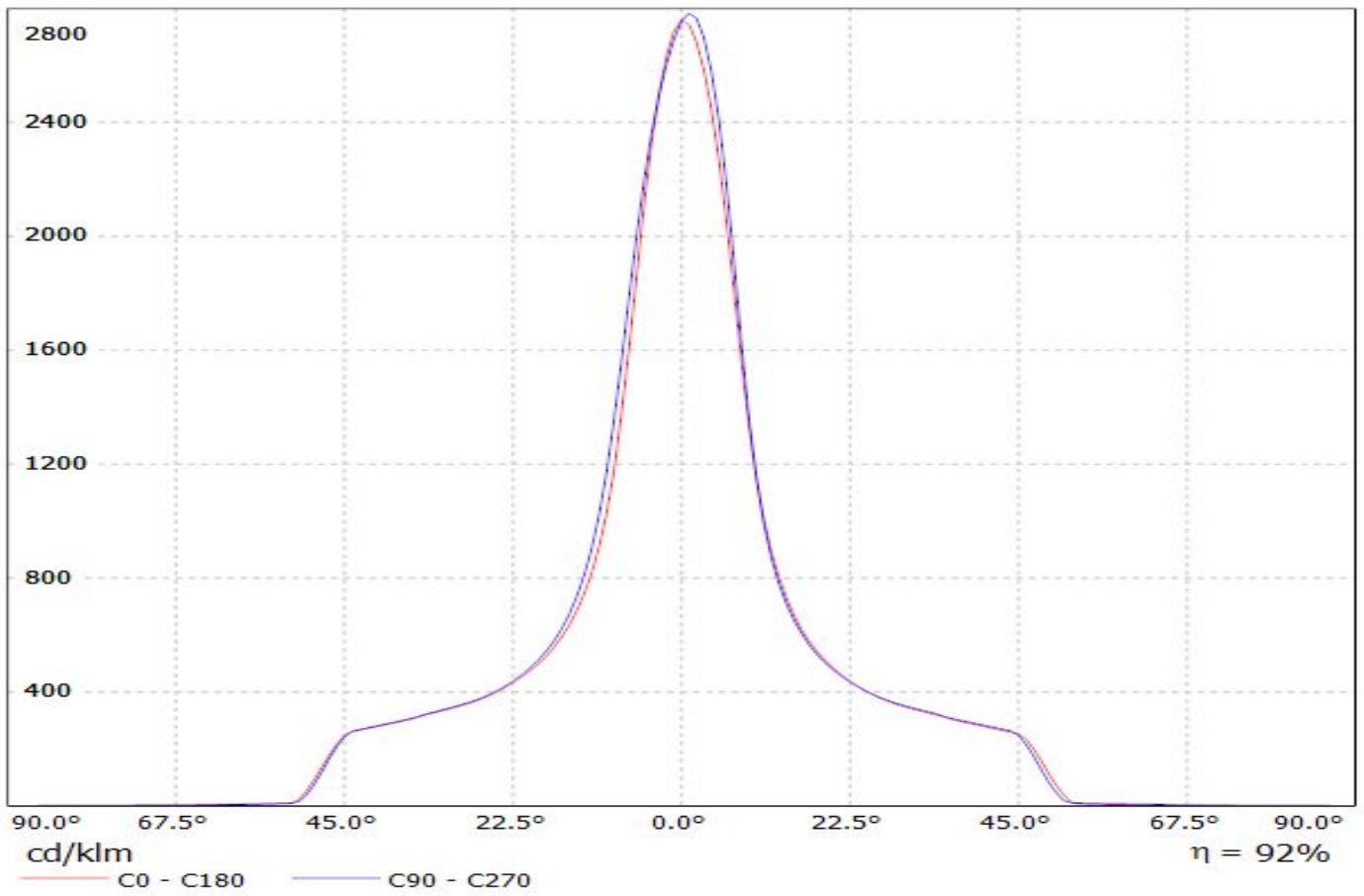

Luminaire: LEDiL Oy FCN13694_ANGELINA-S_(VERO13)_ (VERO13) Eff.93.3%

Lamps: 1 x VERO13_(BXRC-30E2000C) 922.394lm@250mA CCT=3000K P=8 I=250mA

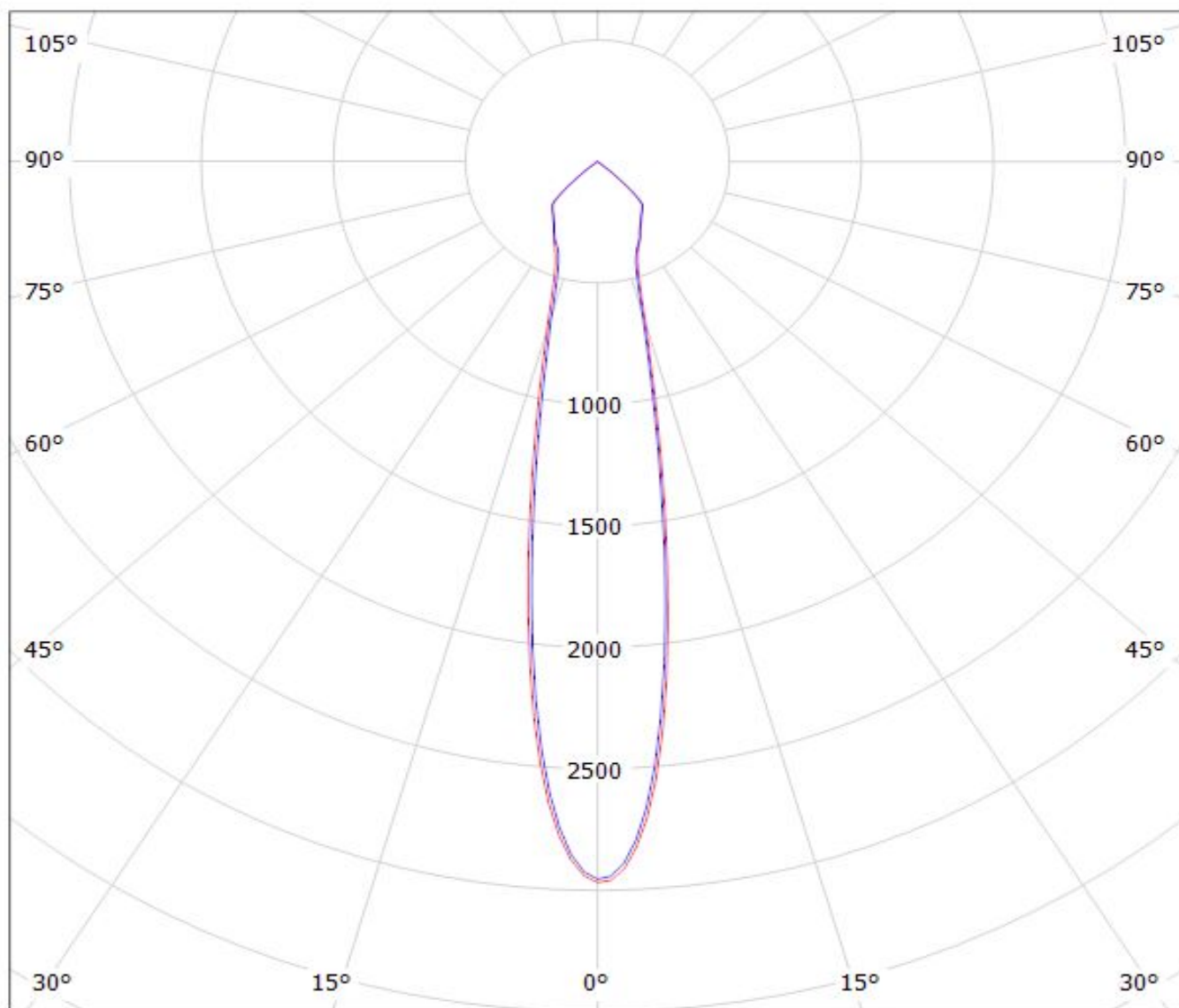

cd/klm

— C0 - C180

— C90 - C270

$\eta = 93\%$

Luminaire: LEDiL Oy FCN13694_ANGELINA-S_(VERO18) Eff.92.2%

Lamps: 1 x VERO18_(BXRC-30E4000F) 906.273lm@250mA CCT=3000K P=7W I=250mA

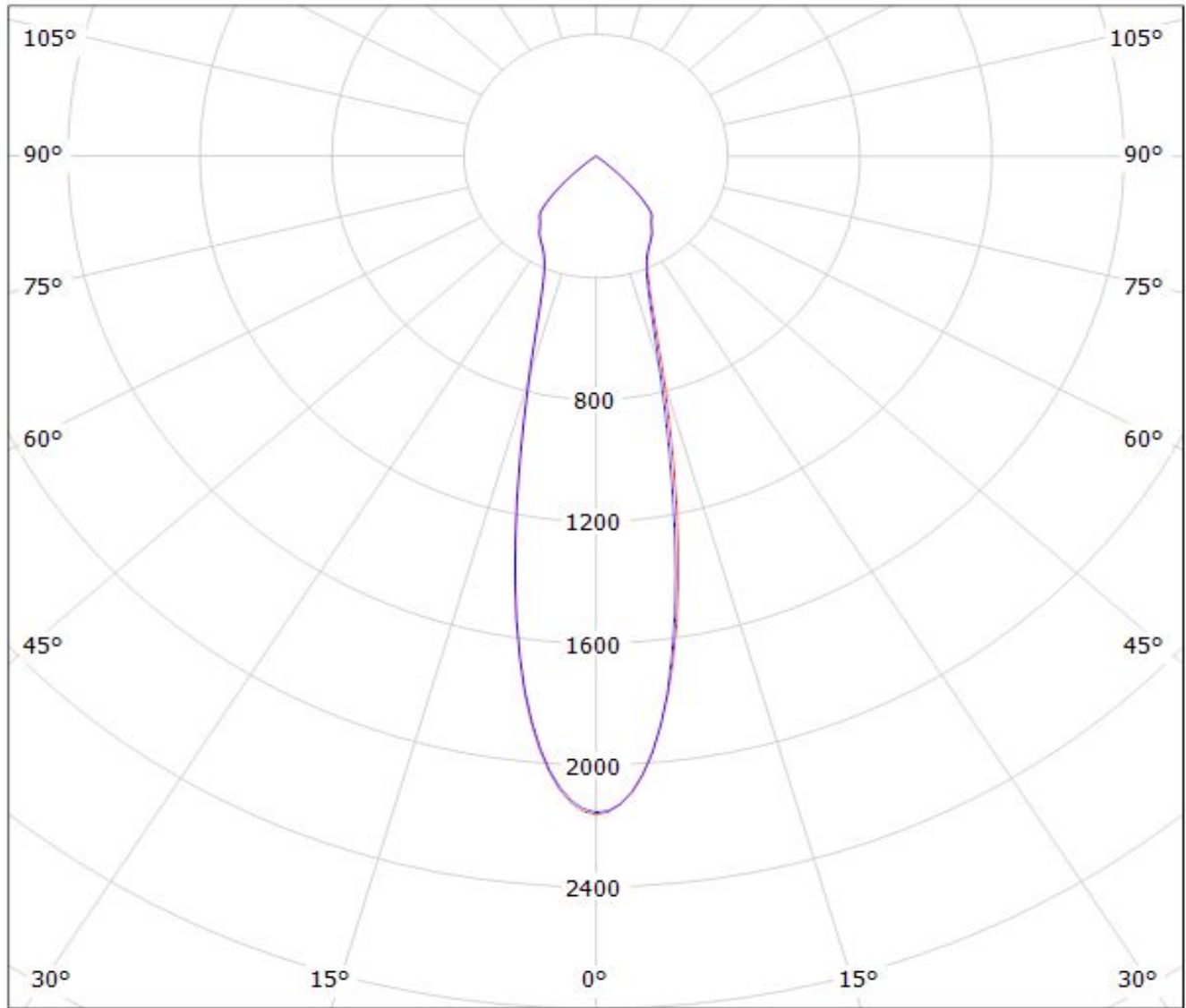

cd/klm

— C0 - C180

— C90 - C270

$\eta = 92\%$

Luminaire: Ledil Oy FCN13694_ANGELINA-S+_B+W_434_TypL1_BRIDGELUX_V10_Gen7_SIMULATED
Lamps: 1 x BRIDGELUX V10 Gen7

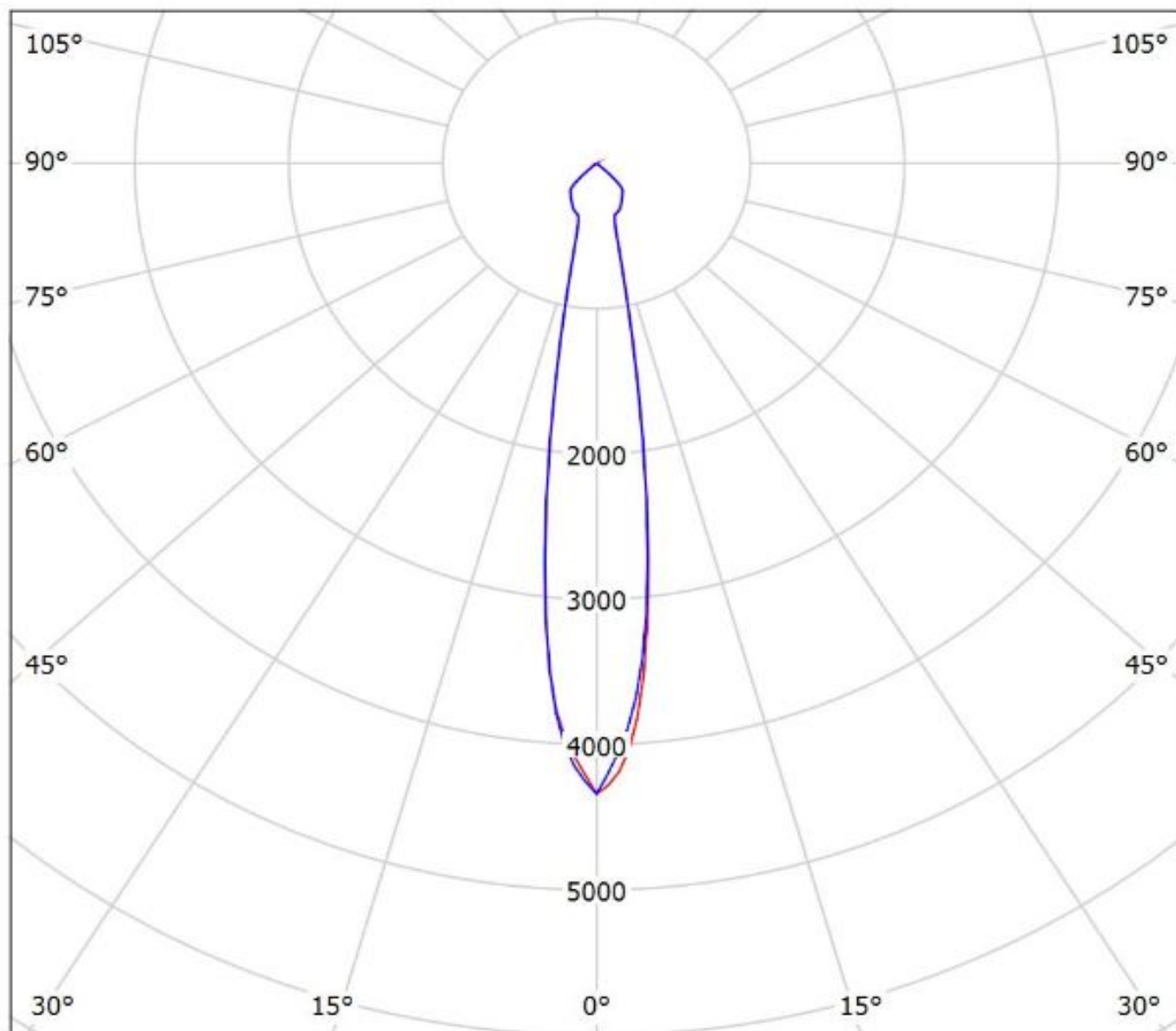

cd/klm

— C0 - C180 — C90 - C270

$\eta = 93\%$

Luminaire: Ledil FCN13694_ANGELINA-S_(CLU034)_ (433_Typ_L1)_ (C13658) Citizen_CLU034_(CLU034-1205B8-303M1A2)_1180.79lm@250mA_P=8.50075W_I=0.25A
Lamps: 1 x Citizen_CLU034_(433_Typ_L1)_ (C13658)_1173.16lm@250mA_P=8.475W_I=0.25A

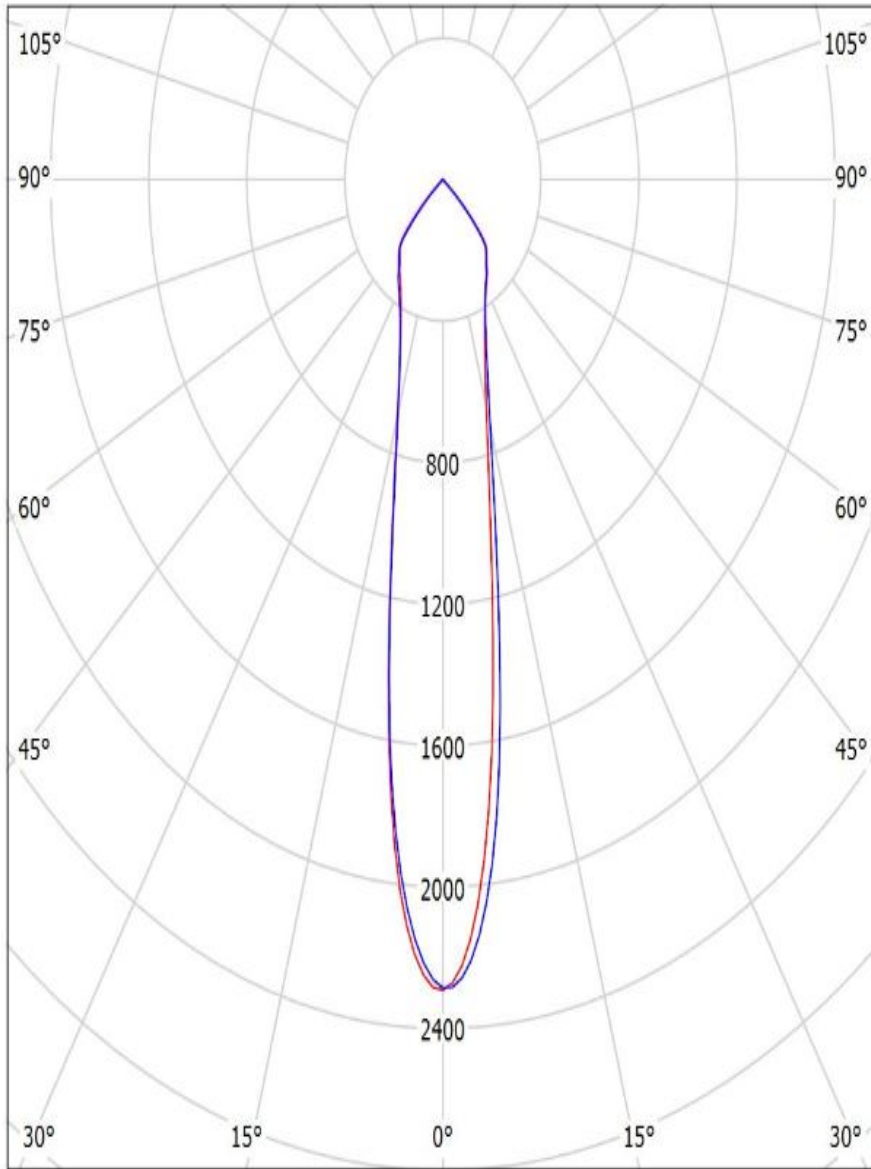

cd/klm
— C0 - C180 — C90 - C270

$\eta = 92\%$

Luminaire: Ledil FCN13694_ANGELINA-S_(CLU700)_ (434_Typ_L1) Citizen_CLU700_(CLU700-1002B8-273M2G1)_390.128lm@100mA_P=3W_I=0.10A
Lamps: 1 x Citizen_CLU700_(CLU700-1002B8-273M2G1)_388.036lm@100mA_P=3W_I=0.10A

