



Chipsmall Limited consists of a professional team with an average of over 10 year of expertise in the distribution of electronic components. Based in Hongkong, we have already established firm and mutual-benefit business relationships with customers from,Europe,America and south Asia,supplying obsolete and hard-to-find components to meet their specific needs.

With the principle of “Quality Parts,Customers Priority,Honest Operation,and Considerate Service”,our business mainly focus on the distribution of electronic components. Line cards we deal with include Microchip,ALPS,ROHM,Xilinx,Pulse,ON,Everlight and Freescale. Main products comprise IC,Modules,Potentiometer,IC Socket,Relay,Connector.Our parts cover such applications as commercial,industrial, and automotives areas.

We are looking forward to setting up business relationship with you and hope to provide you with the best service and solution. Let us make a better world for our industry!



Contact us

Tel: +86-755-8981 8866 Fax: +86-755-8427 6832

Email & Skype: info@chipsmall.com Web: www.chipsmall.com

Address: A1208, Overseas Decoration Building, #122 Zhenhua RD., Futian, Shenzhen, China



DETAILS

Product Number	FCN13696_ANGELINA-W
Family	ANGELINA
Type	RefPack
Color	metal
Diameter	82 mm
Height	36,04 mm
Style	round
Optic Material	
Holder Material	
Fastening	screw
Status	production ready
ROHS Compliant	Yes
Date Updated	3/11/2016



OPTICAL PROPERTIES

LED	Viewing Angle	Light Beam	Efficiency	cd/lm	Connector
VERO13	49 deg	Wide	92 %	1.100	LEDiL: LEDiL
VERO18	55 deg	Wide	92 %	1.000	LEDiL: LEDiL
V15 Gen6	51 deg	Wide	93 %	1.100	Bender Wirth: 456 Typ L2
V10 Gen7	sim: 50	Wide	sim: 93 %	sim: 1.190	Bender Wirth: 434 Typ L1
CLL03x/CLU03x	52 deg	Wide	92 %	1.000	Bender Wirth: 433 Typ L1
CLU700/701	42 deg	Wide	92 %	1.200	Bender Wirth: 434 Typ L1
CLL02x/CLU02x (LES10)	45 deg	Wide	93 %	1.100	Bender Wirth: 434 Typ L1
CLU720/721	48 deg	Wide	92 %	1.700	-
CXA/B 1816 & CXA/B 1820 & CXA 1850	50 deg	Wide	92 %	1.000	Bender Wirth: 437 Typ L1
CXA/B 15xx	42 deg	Wide	93 %	1.200	Bender Wirth: 441 Typ L1
LUXEON CoB 1202/1203	45 deg	Wide	93 %	1.100	Bender Wirth: 438 Typ L1
CXM-14	sim: 52	Wide	sim: 92 %	sim: 1.000	Bender Wirth: 433 Typ L1
CXM-9	sim: 45	Wide	sim: 93 %	sim: 1.100	Bender Wirth: 434 Typ L1
COB J-Type	51 deg	Wide	93 %	1.000	Bender Wirth: 463 Typ L2
COB L-Type (LES 11)	47 deg	Wide	92 %	1.100	Bender Wirth: 438 Typ L1
Solerialq P9	44 deg	Wide	92 %	1.200	Bender Wirth: 461 Typ L1
Solerialq P13	44 deg	Wide	92 %	1.100	Bender Wirth: 437 Typ L1
Solerialq S13	49 deg	Wide	92 %	1.100	Bender Wirth: 437 Typ L1
LC026B/LC040B	54 deg	Wide	92 %	0.950	Bender Wirth: 450 Typ L2
ZC12/18	sim: 52	Wide	sim: 92 %	sim: 1.000	Bender Wirth: 433 Typ L1
ZC4/6	sim: 45	Wide	sim: 93 %	sim: 1.100	Bender Wirth: 434 Typ L1
SLE G5 LES11	47 deg	Wide	92 %	1.100	Bender Wirth: 434 Typ L1

Relative intensity of FCN13696_ANGELINA-W_(V15)

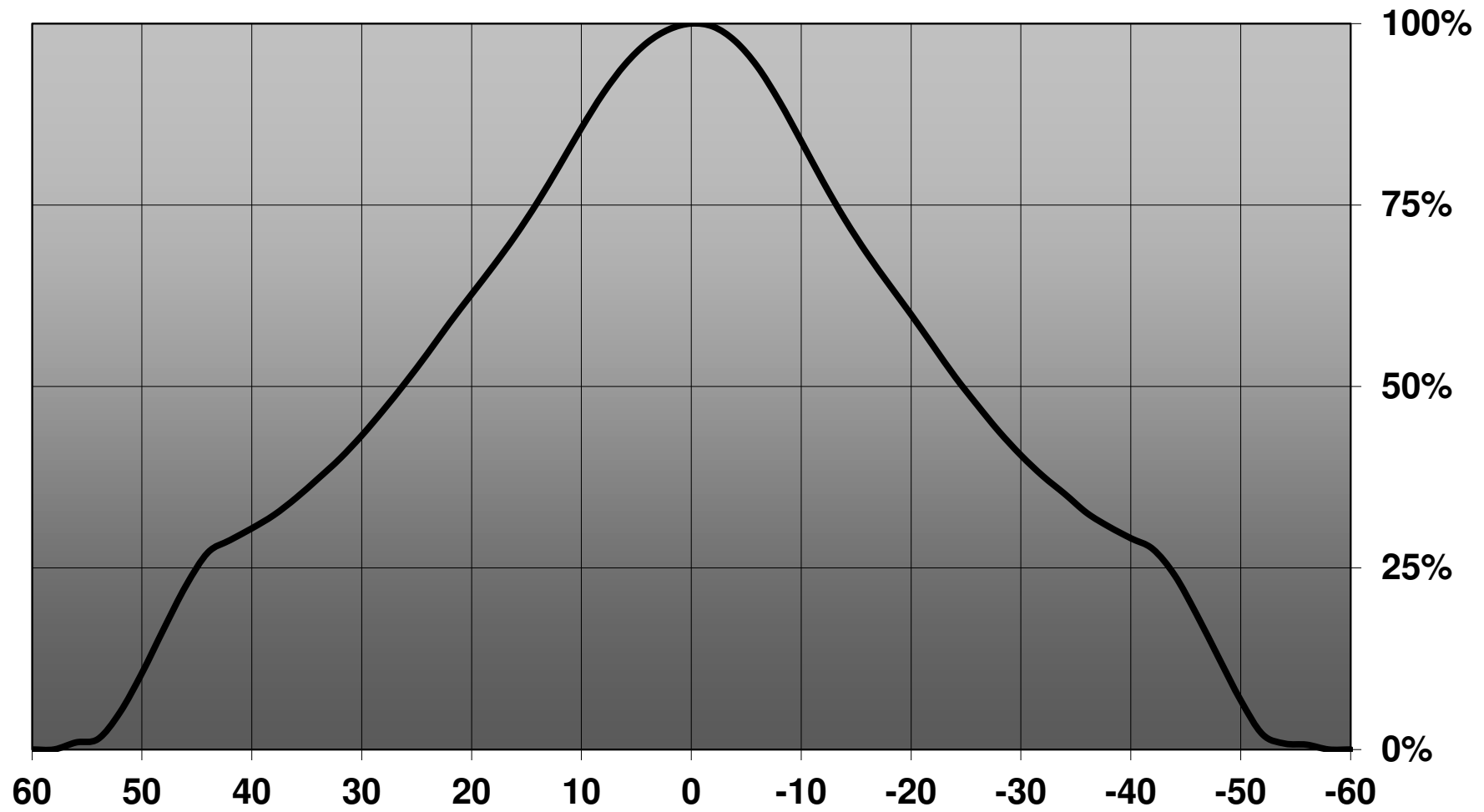

H G F E D C B A

4

3

2

1

4

3

2

1

31 + Basepart

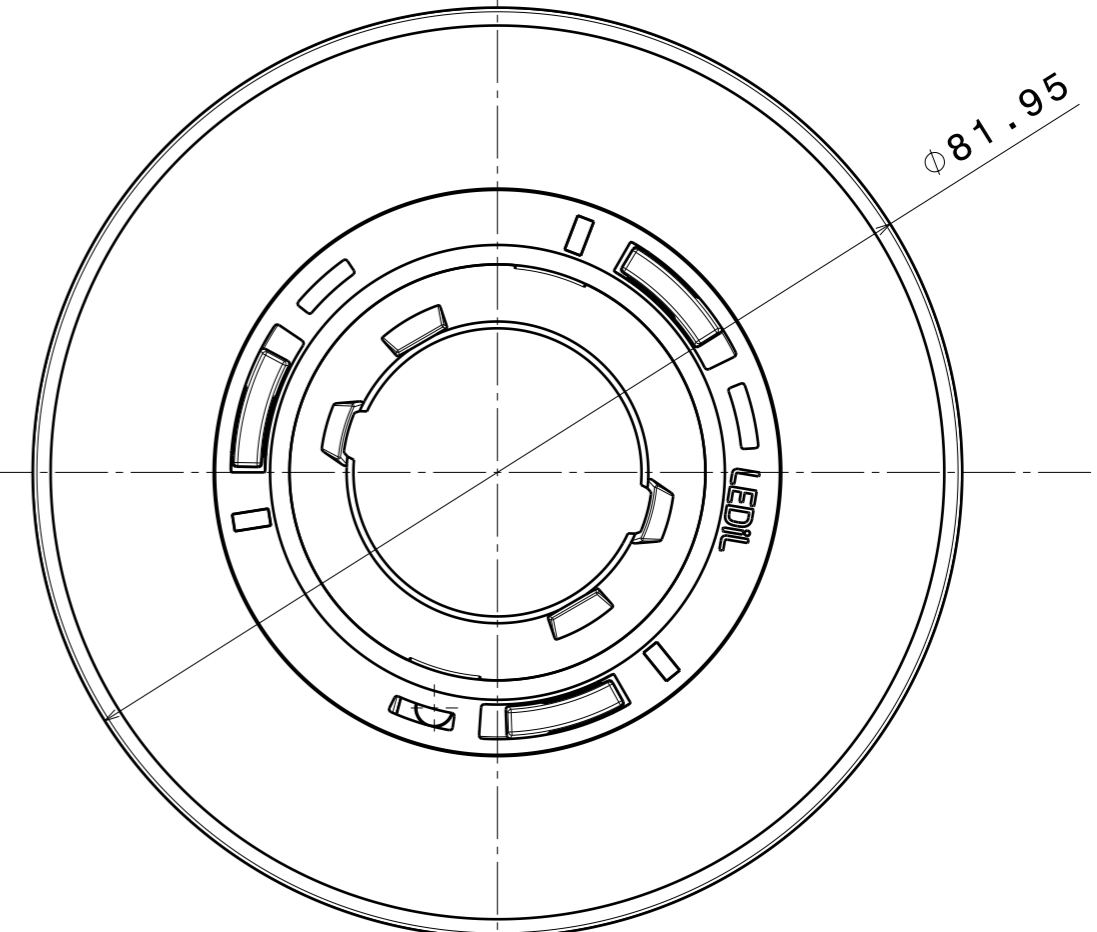
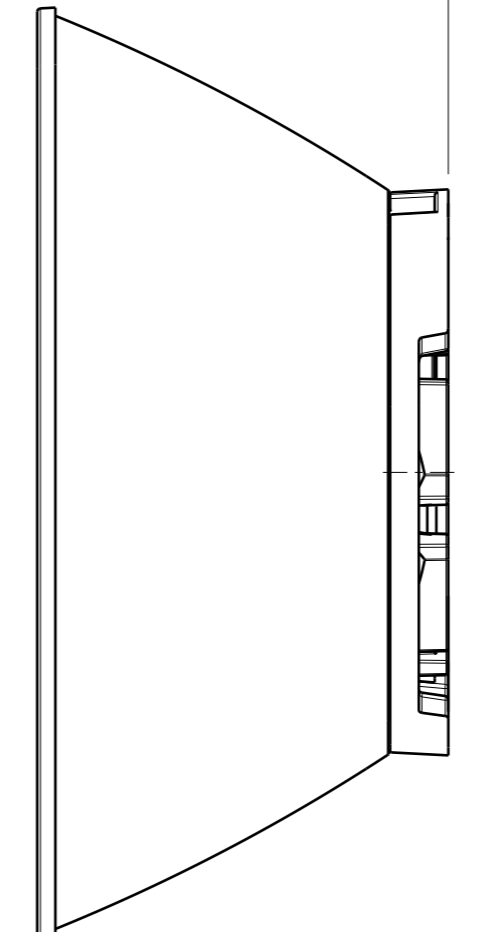
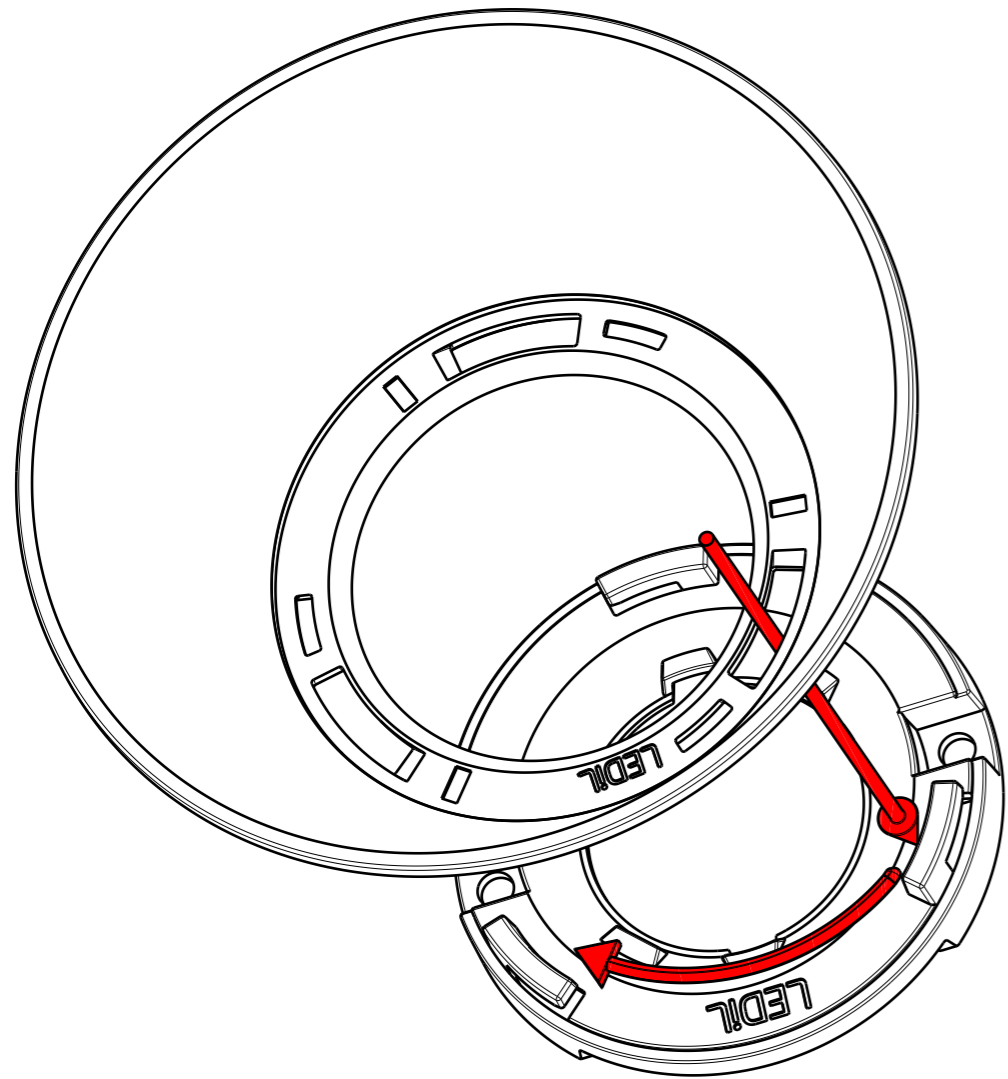

Tolerances if not otherwise shown
 According to DIN ISO 2768-1
 Linear measures:
 Up to 30mm class M, otherwise class C.
 According to DIN ISO 2768-2
 Form and position: class L

LEDiL LediL Oy
 Salorankatu 10
 FIN 24240 SALO
 Finland

THIRD ANGLE PROJECTION:

DRAWING TITLE
Datasheet_ANGELINA + CLAMP

This drawing is the property of LEDiL Oy. It may not be reproduced, copied or communicated without a written agreement with LEDiL Oy.

SIZE	PART NUMBER		
A3	-		

SCALE	3:2	WEIGHT (g)		SHEET	1/1
-------	-----	------------	--	-------	-----

H G F E D C B A

Luminaire: LEDiL Oy FCN13696_ANGELINA-W_(VERO13) Eff.92.4%
Lamps: 1 x VERO13_(BXRC-30E2000C) 922.394lm@250mA CCT=3000K P=8 I=250mA

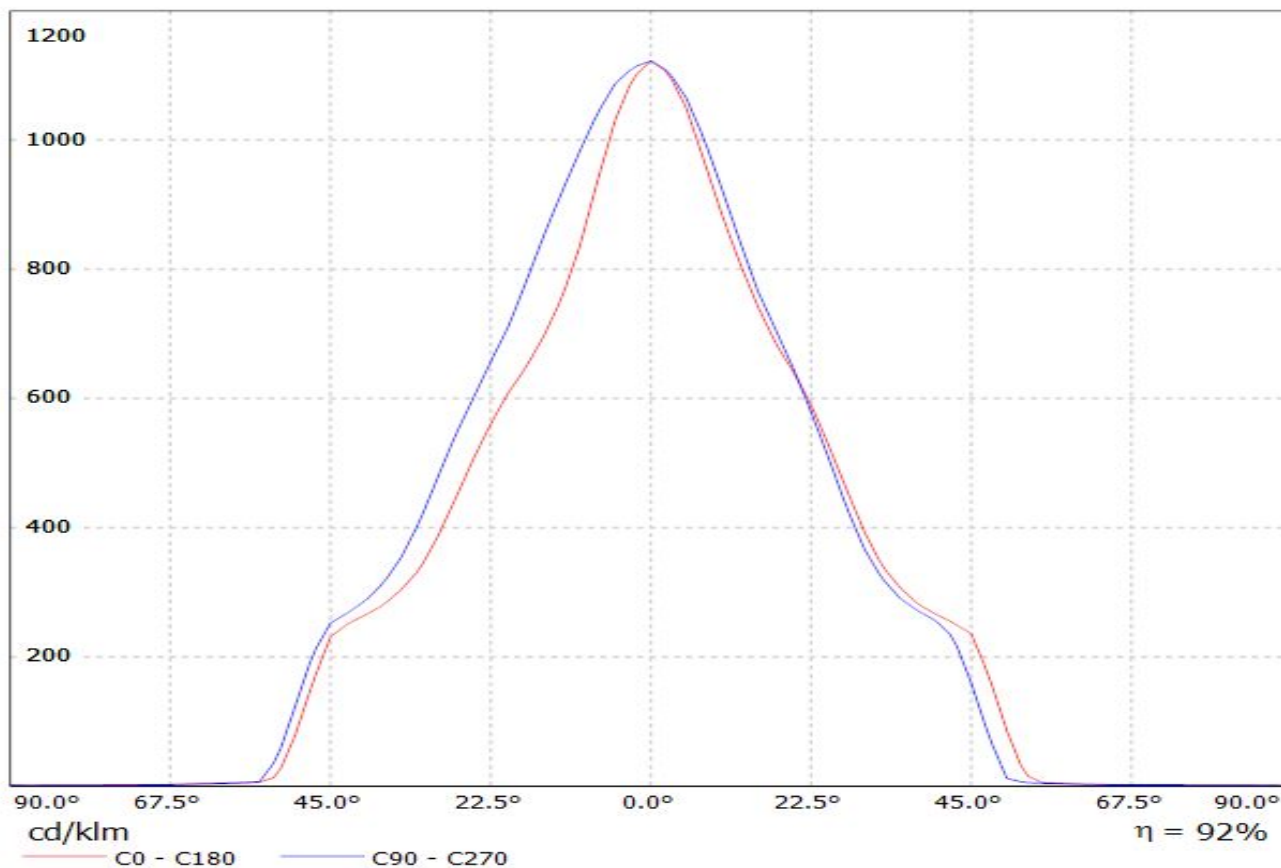

Luminaire: LEDiL Oy FCN13696_ANGELINA-W_(VERO18) Eff.91,7%
Lamps: 1 x VERO18_(BXRC-30E4000F) 906.273lm@250mA CCT=3000K P=7 I=250mA

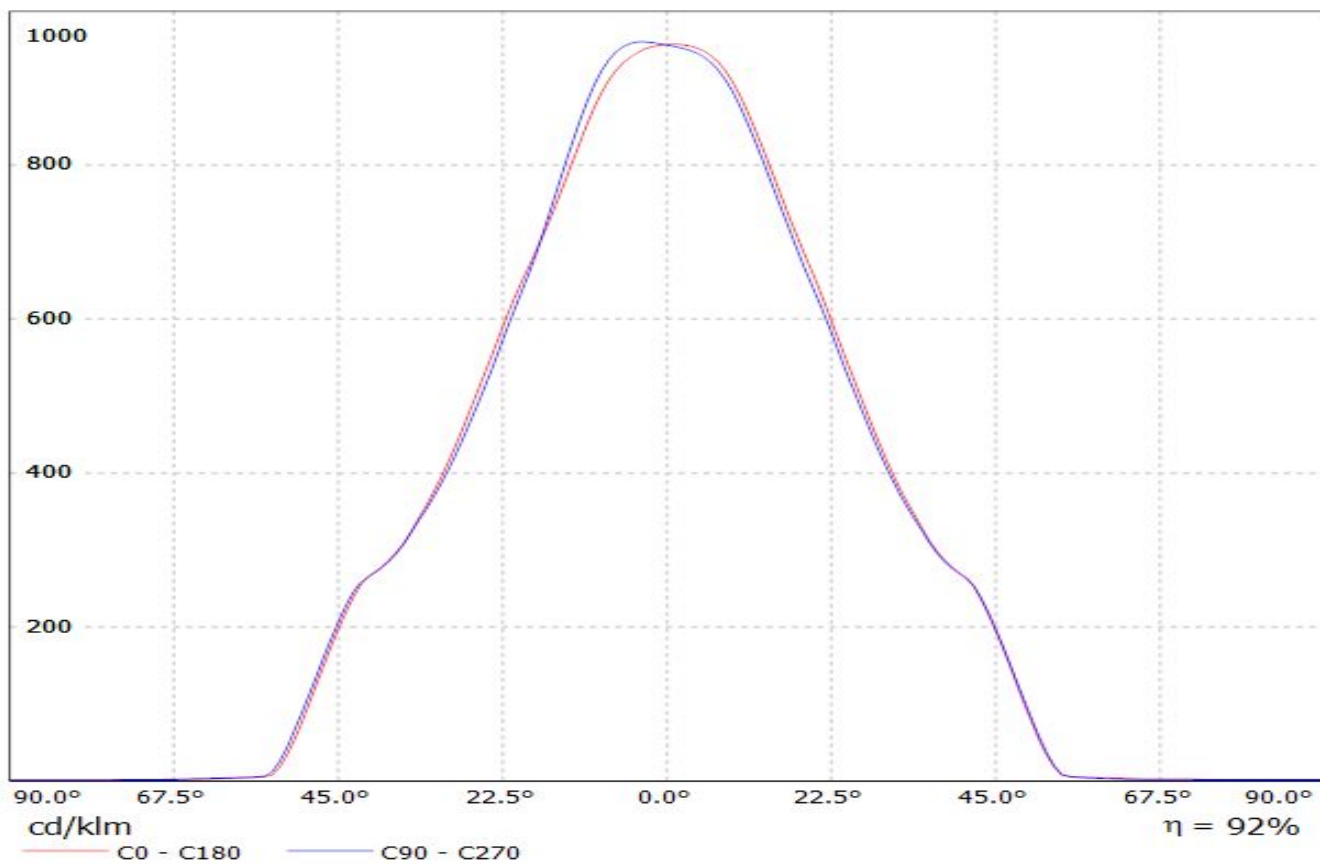

Luminaire: Ledil Oy FCN13696_ANGELINA-W+_B+W_434_TypL1_BRIDGELUX_V10_Gen7_SIMULATED
Lamps: 1 x BRIDGELUX V10 Gen7

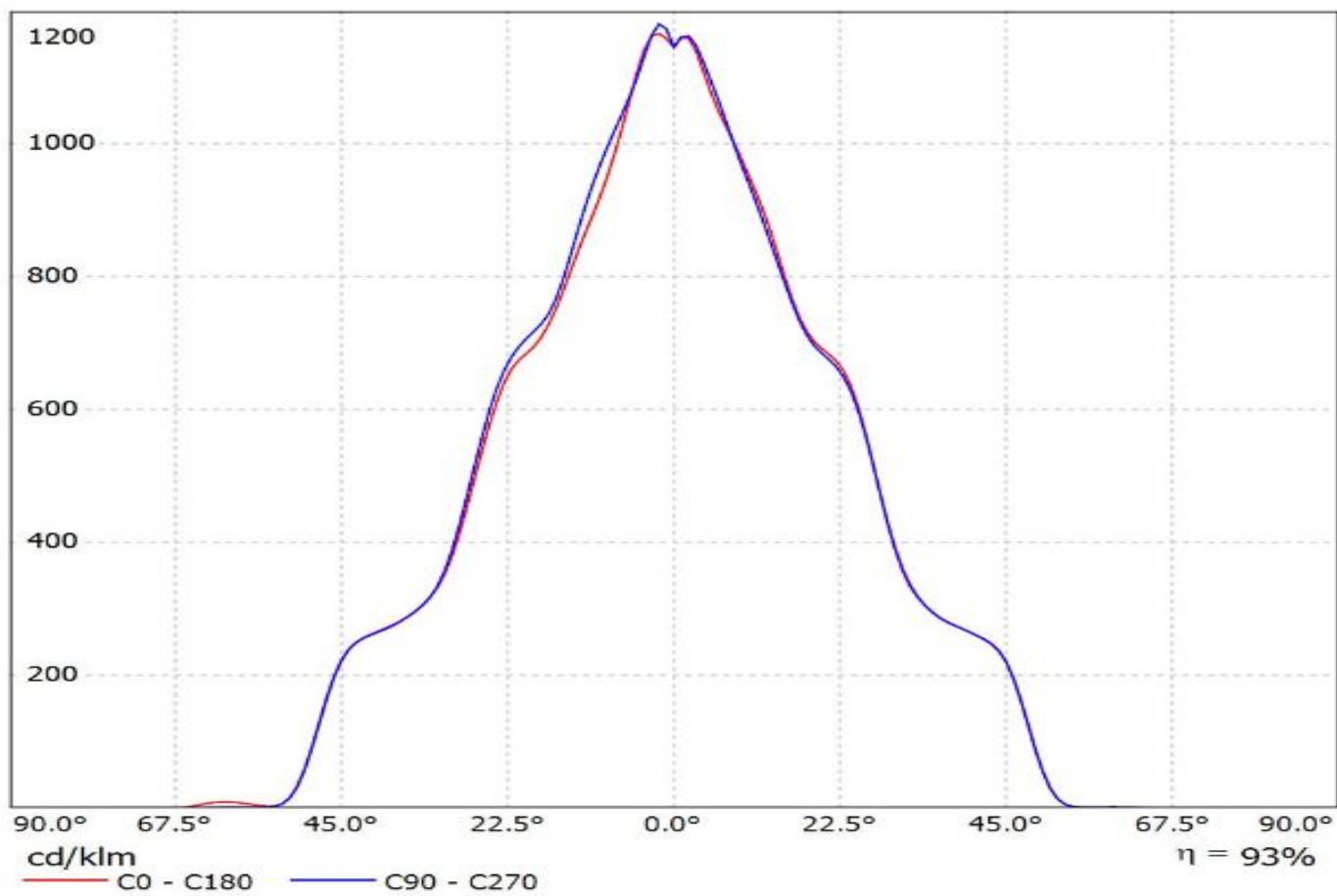

Luminaire: Ledil FCN13696_ANGELINA-W_(CLU034)_ (433_Typ_L1)_ (C13658) Citizen_CLU034_(CLU034-1205B8-303M1A2)_1180.79lm@250mA_P=8.50075W_I=0.25A
Lamps: 1 x Citizen_CLU034_(433_Typ_L1)_ (C13658)_1173.16lm@250mA_P=8.475W_I=0.25A

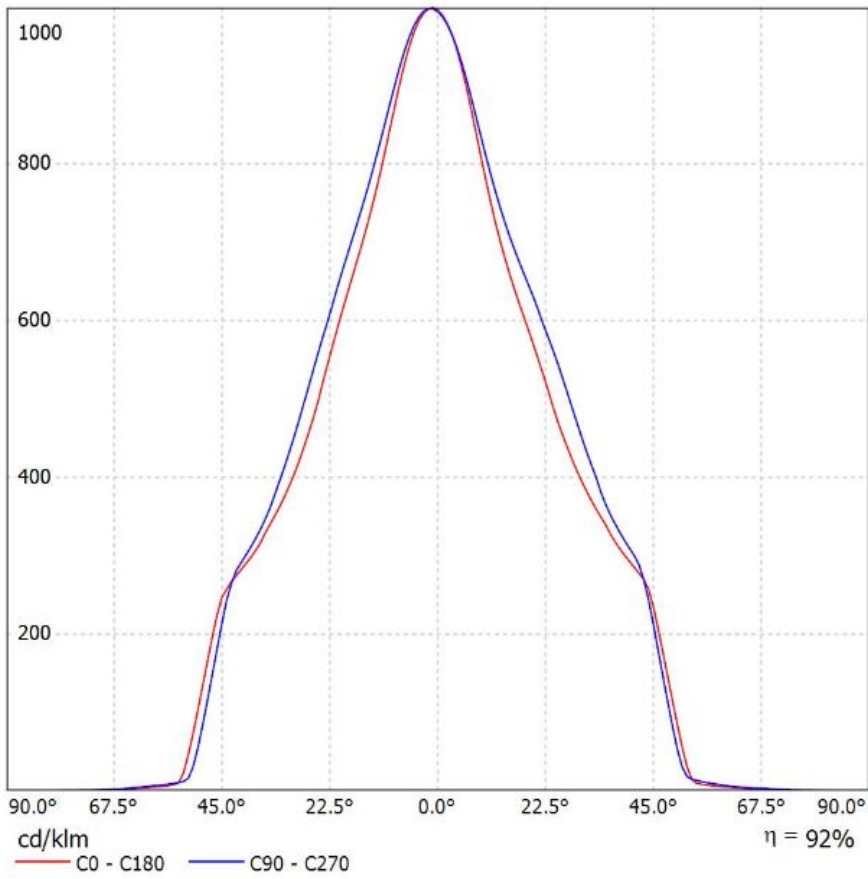

Luminaire: Ledil FCN13696_ANGELINA-W_(CLU700)_434_Typ_L1 Citizen_CLU700_(CLU700-1002B8-273M2G1)_390.128lm@100mA_P=3W_I=0.10A
Lamps: 1 x Citizen_CLU700_(CLU700-1002B8-273M2G1)_388.036lm@100mA_P=3W_I=0.10A

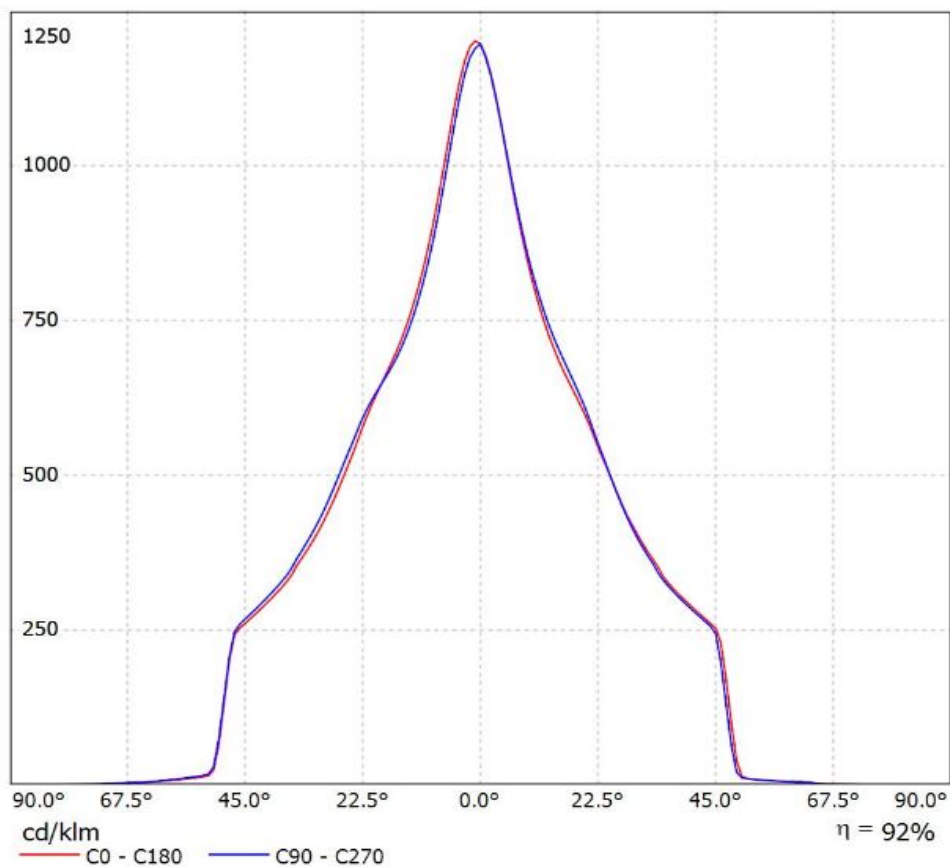

Luminaire: Ledil FCN13696_ANGELINA-W_(CLU024)_(433_Typ_L1) Citizen_CLU024_(433_Typ_L1)
(C13658_CLAMP-VERO13-18)_1071.07lm@250mA_P=8.43W_I=0.25A
Lamps: 1 x Citizen_CLU024_(433_Typ_L1)(C13658_CLAMP-VERO13-18)
_1071.07lm@250mA_P=8.43W_I=0.25A

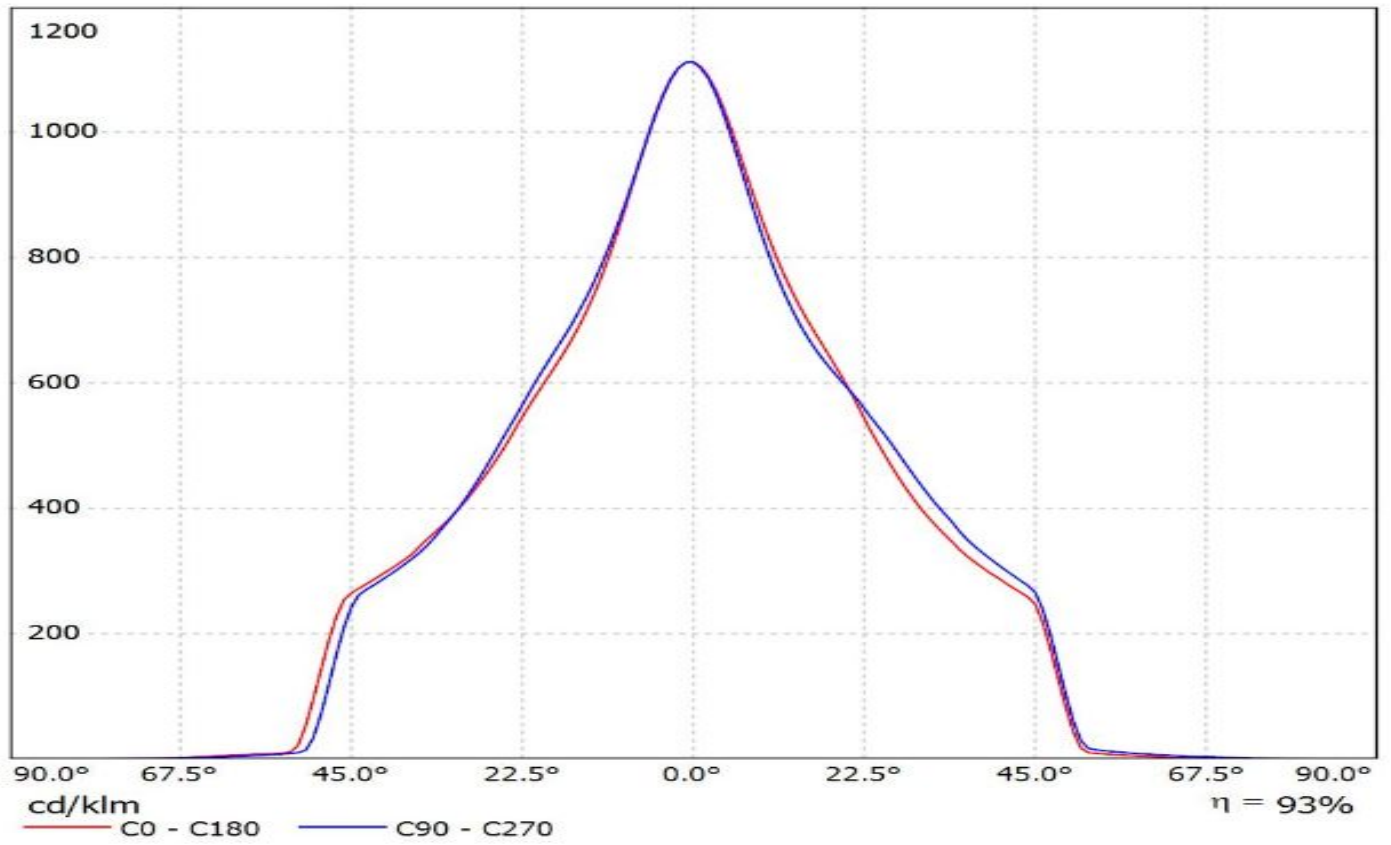

Luminaire: Ledil FCN13696_ANGELINA-W_(CLU720)_(433_Typ_L1)

Lamps: 1 x Citizen_CLU720_(CLU720-1206B8-273M2G1)_1225.89lm@250mA_P=8.3W_I=0.25A

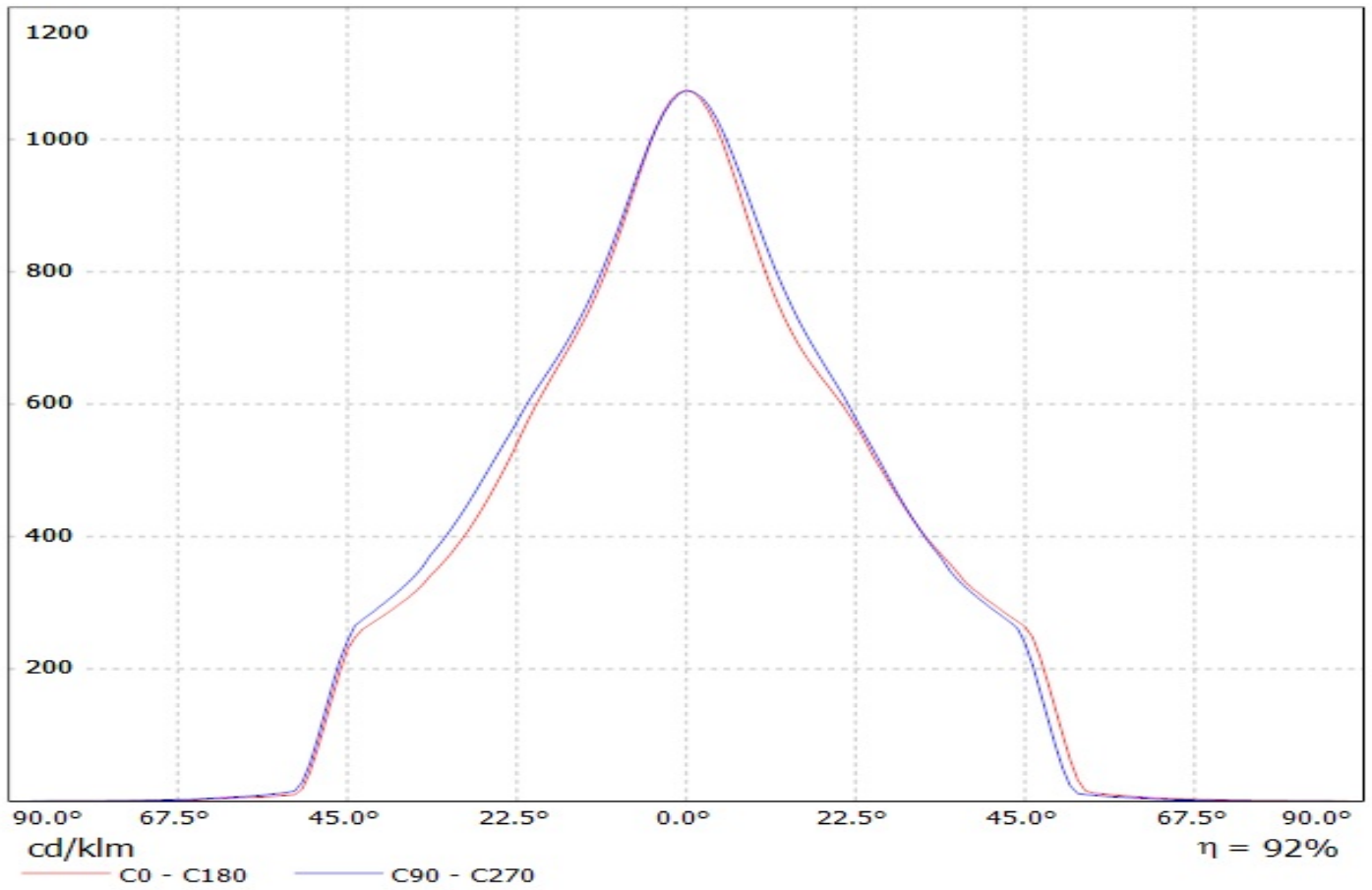

Luminaire: Ledil FCN13696_ANGELINA-W_(CXA1850)

Lamps: 1 x CREE_CXA1850_(CXA1850-30F-T4-N0Y-00001)_831.914lm@250mA_CCT=3000K_P=8.27W_I=0.25A

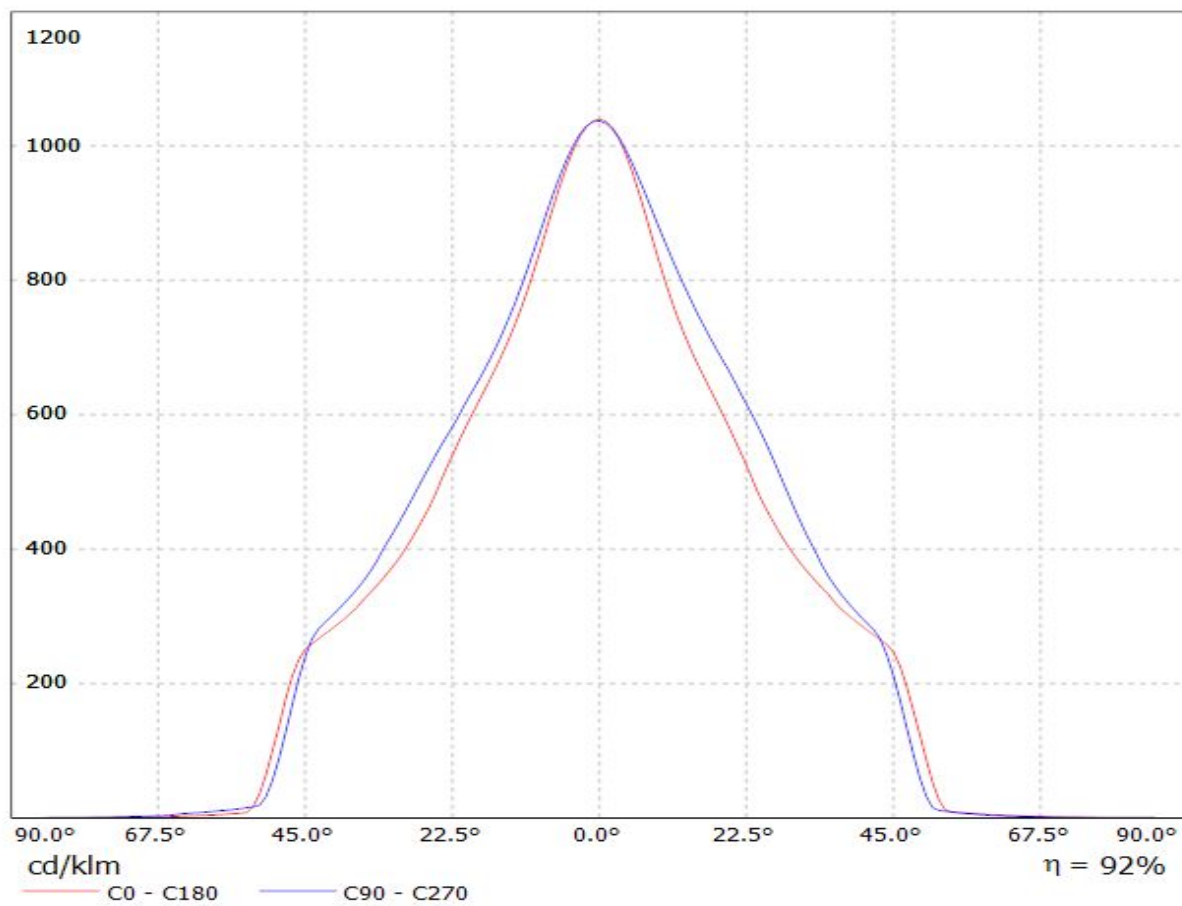

Luminaire: LEDiL Oy FCN13696_ANGELINA-W_(CXA1520)_ (441_Typ_L1)

Lamps: 1 x Cree_CXA1520_(CXA1520-30F-N4-N0H-00001)_993.209lm@250mA_P=8.74575W_I=0.2499A

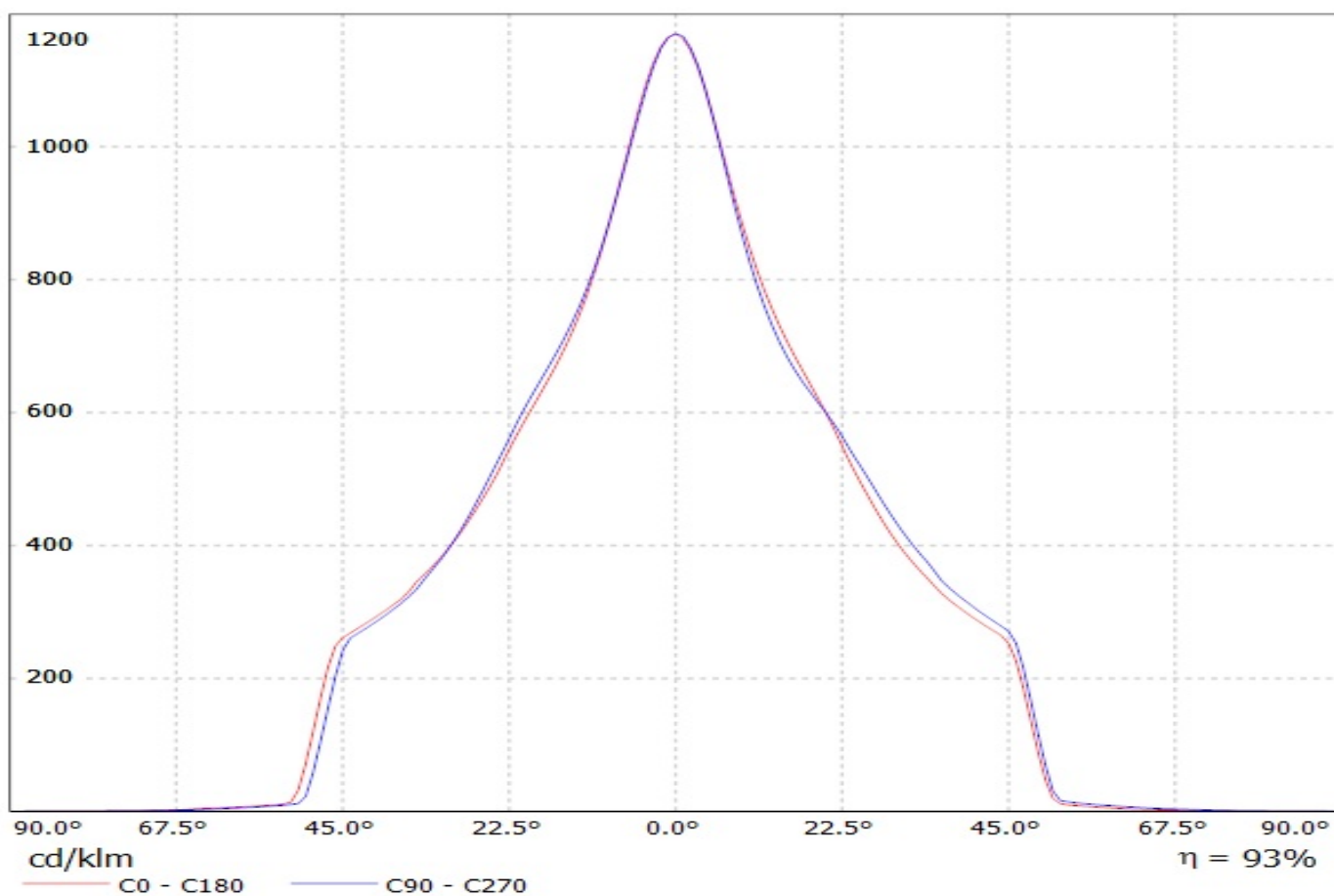

Luminaire: LEDiL Oy FCN13696_ANGELINA-W_(LUXEON_CoB_1203)_ (438_Typ_L1)_ (C13658_CLAMP-VERO13-18)
Lamps: 1 x LUXEON_CoB_1203_(438_Typ_L1)_ (C13658_CLAMP-VERO13-18)_984.561lm@250mA_P=8.6828W_I=0.25A

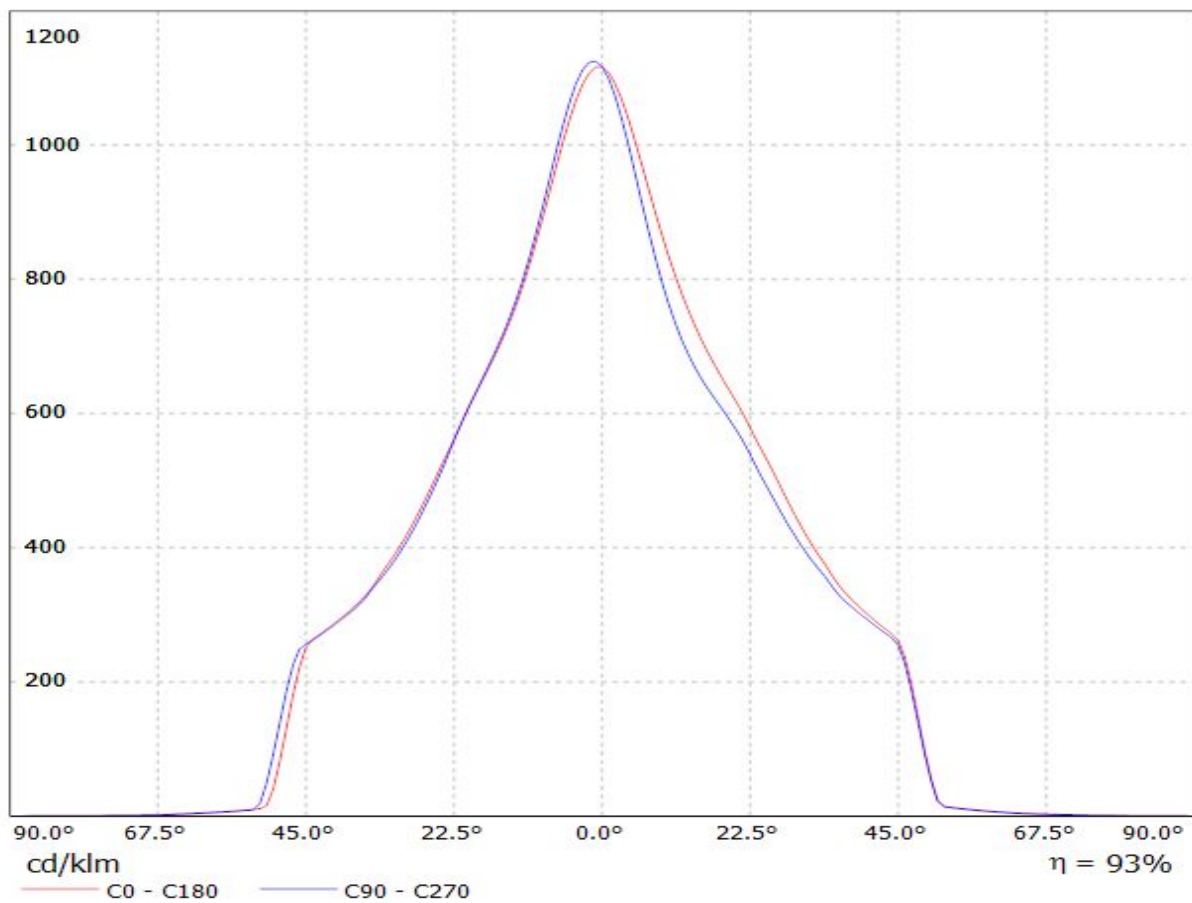

Luminaire: LEDiL Oy FCN13696_ANGELINA-W_(NFDxJ130B)

Lamps: 1 x Nichia_NFDxJ130B_(463 Typ L2)_C13658_CLAMP-VERO13-18_1458.51lm@250mA_P=8.87739W_I=0.2498A

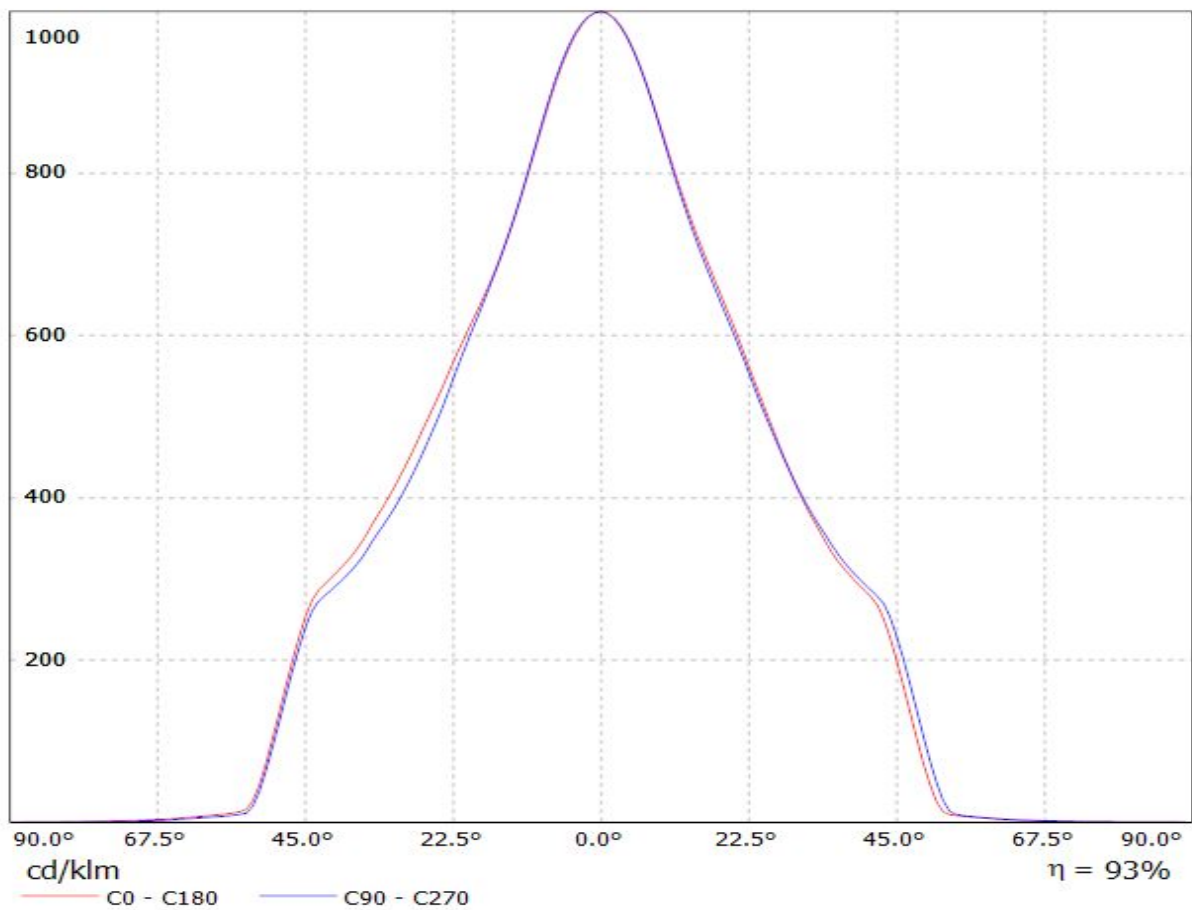

Luminaire: LEDiL Oy FCN13696_ANGELINA-W (NFCxL060B)_(438_Typ_L1)

Lamps: 1 x Nichia_NFCxL060B_(SM403G2450R8000)_(C13658)_(438_Typ_L1)_1298.52@250mA_P=8.45498W_I=0.2498A

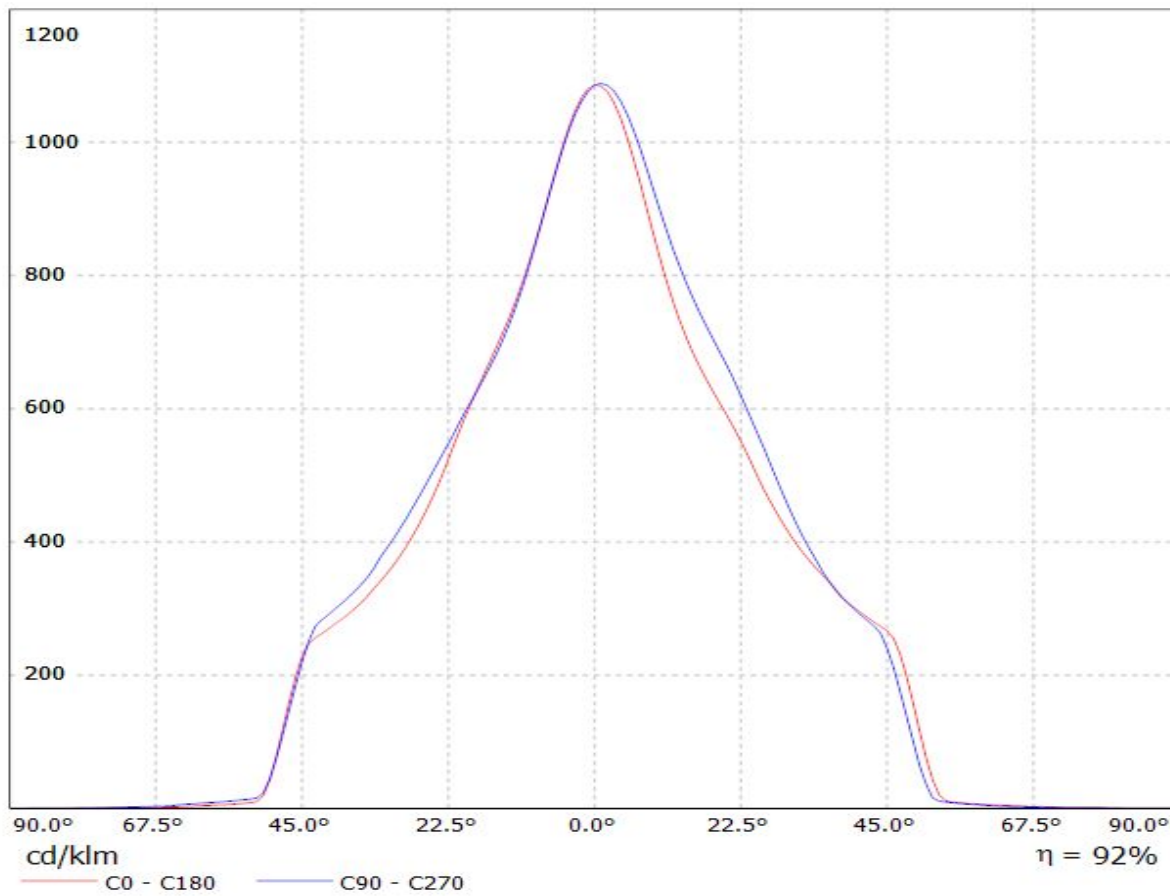

Luminaire: Ledil FCN13696_ANGELINA-W_(Soleriq_P9)_+_Bender+Wirth_461
Lamps: 1 x Osram_Soleriq_P9_(GW_MAFJB1.EM)_895.446lm@250mA_CCT=4299K_P=6.9W_I=0.25A

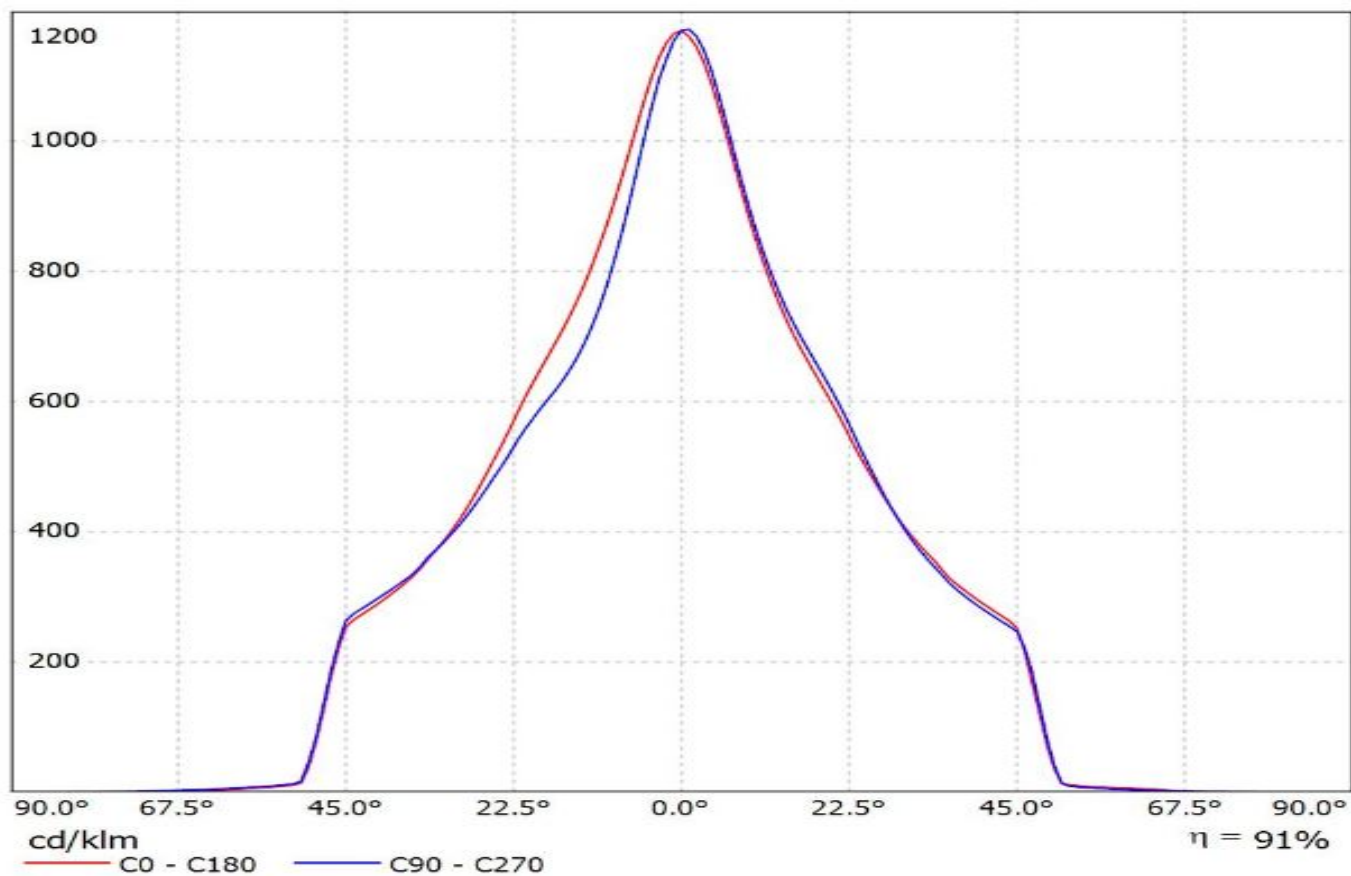

Luminaire: Ledil FCN13696_ANGELINA-W_(Soleriq_P13)

Lamps: 1 x Osman_Soleriq_P13_1009.11lm@250mA_P=6.9385W_I=0.25A

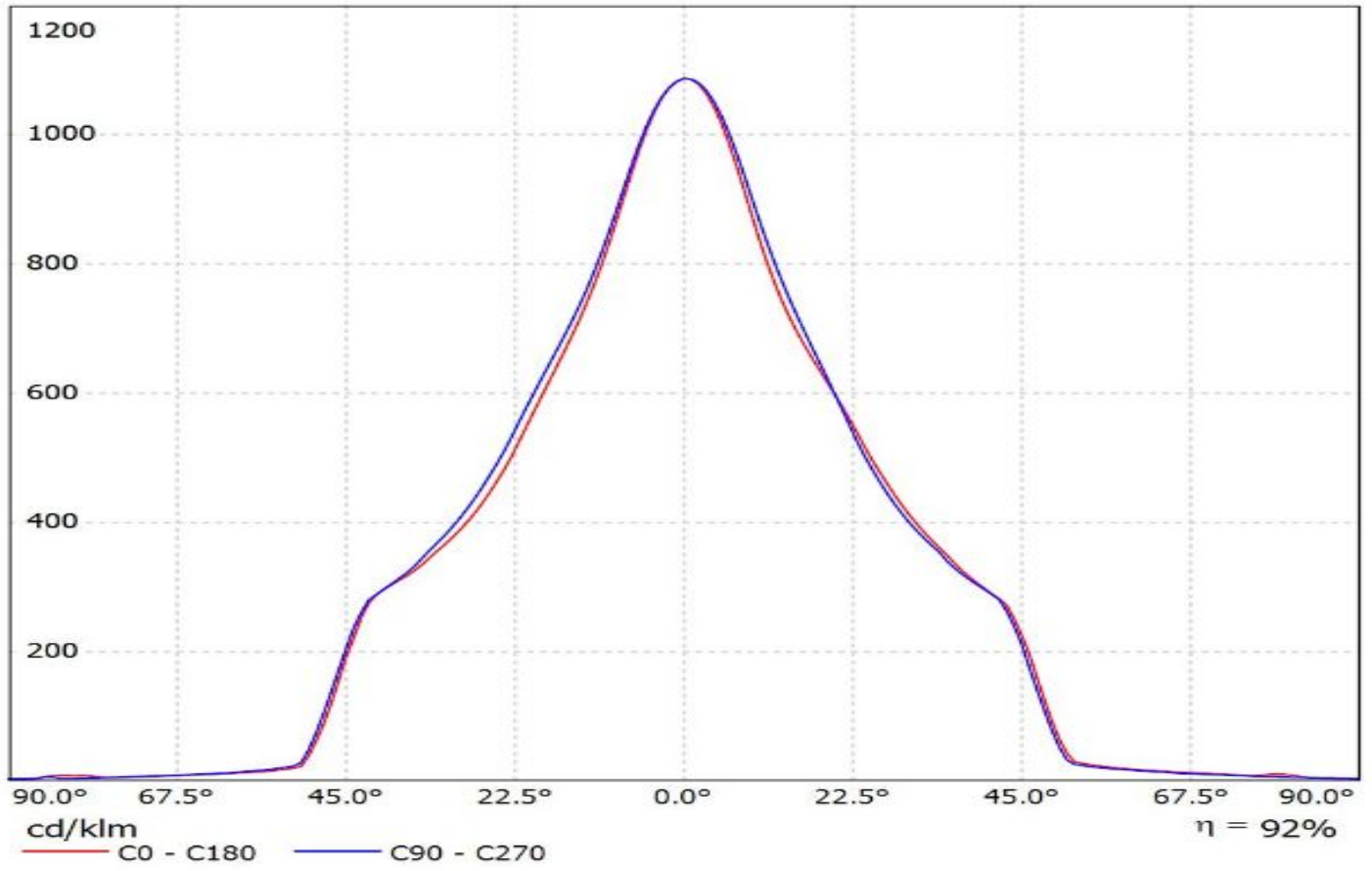

Ledil FCN13696_ANGELINA-W_(Soleriq_S13) / LDC (Linear)

Luminaire: Ledil FCN13696_ANGELINA-W_(Soleriq_S13)

Lamps: 1 x Osram_Soleriq_S13_(GW_KAGHB1.EM)_896.727lm@250mA_P=7.44679W_I=250mA

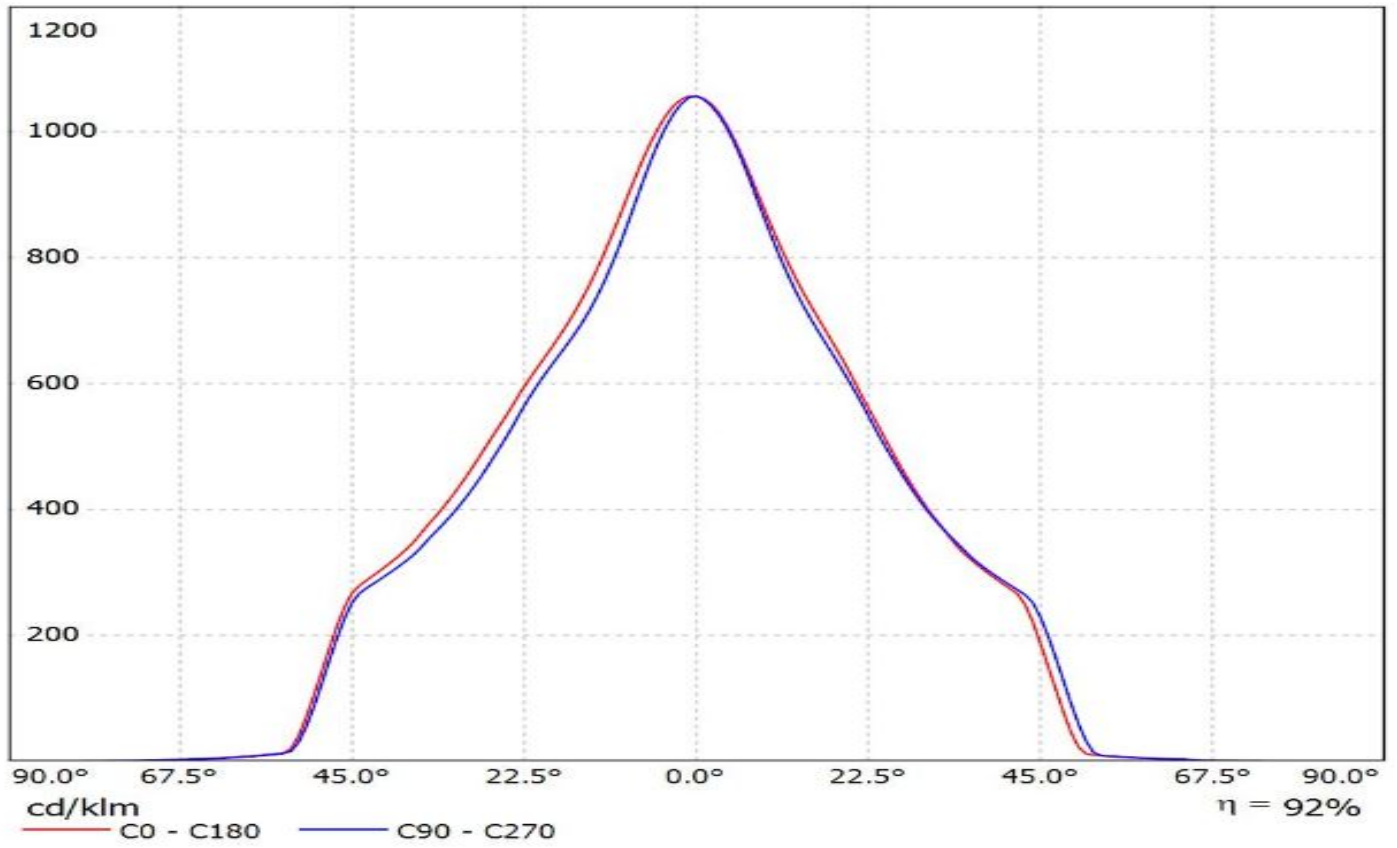

Luminaire: Ledil FCN13696_ANGELINA-W_(LC040B)_(450_Typ_L2)_(C13658_CLAMP-VERO13-18)
Lamps: 1 x Samsung_LC040B_CCT=3000K_(SPHWW1HDNE25010101)_(450_Typ_L2)_(C13658_CLAMP-VERO13-18)_1103.62lm@250mA_P=8.2W_I=0.25A

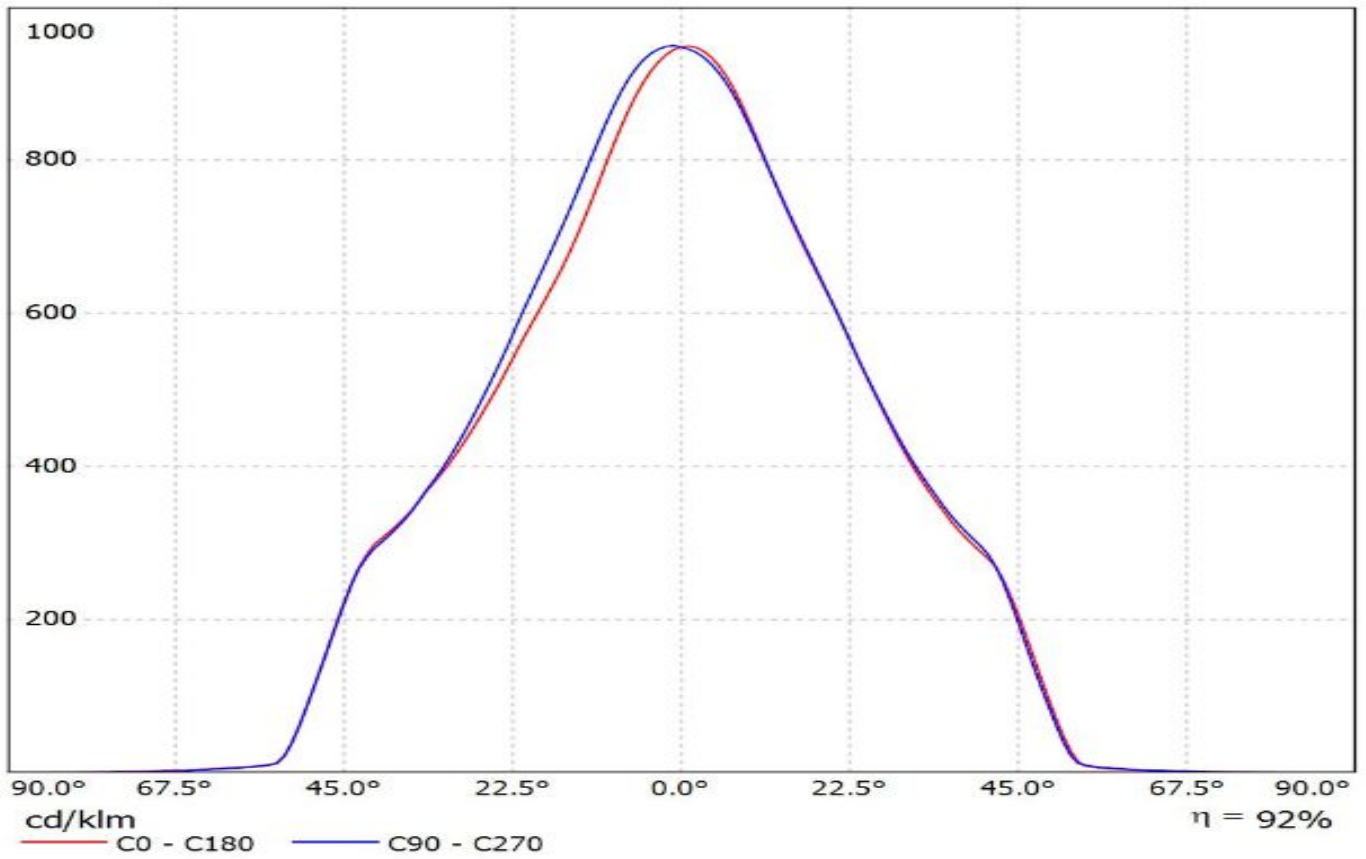

Luminaire: LEDiL Oy FCN13696_ANGELINA-W_(SLE-G5_LES-11)
Lamps: 1 x Tridonic_SLE-G5_LES-11_1137.55lm@250mA_P=8.4177W_I=0.250A

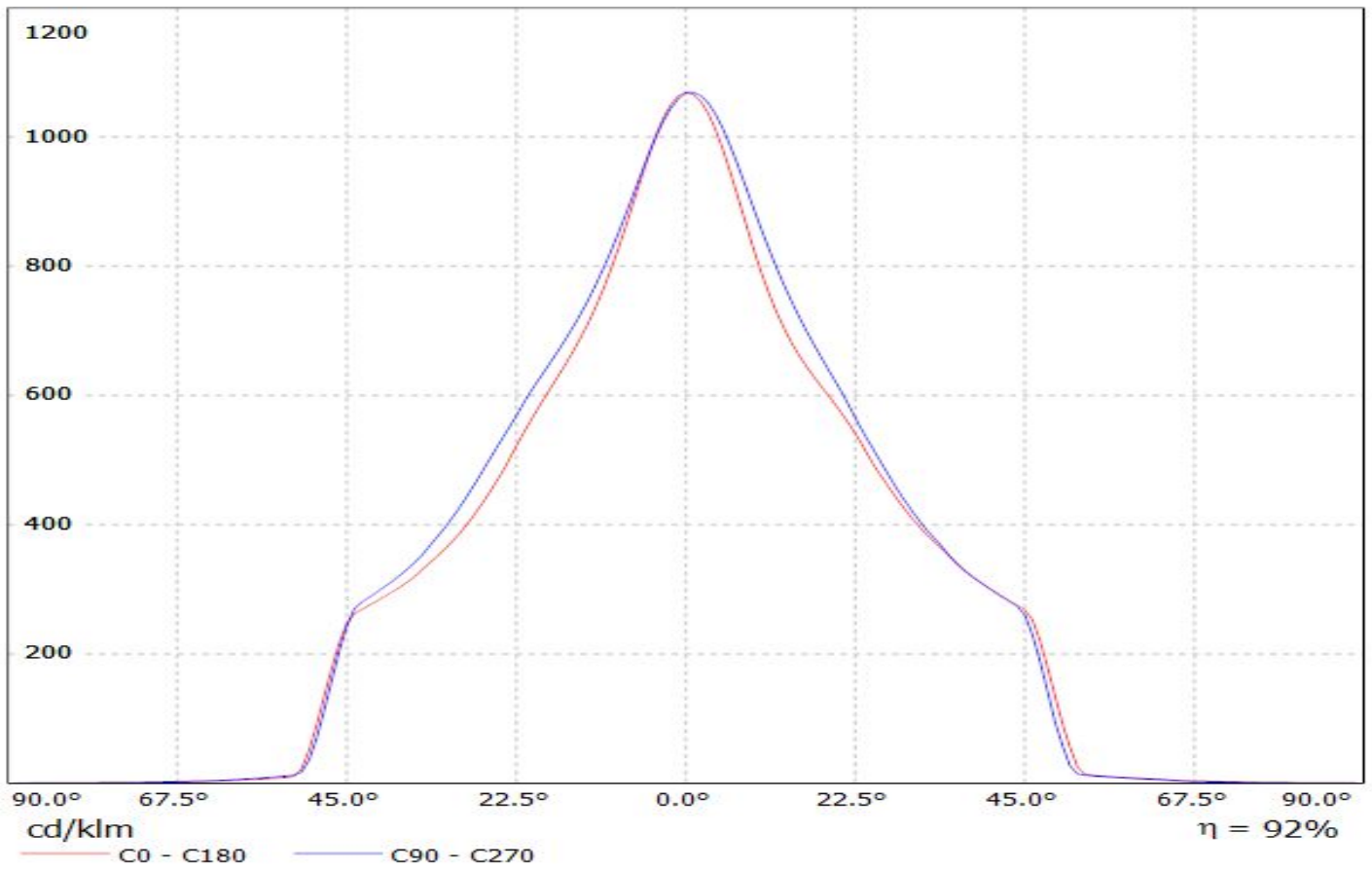

Luminaire: LEDiL Oy FCN13696_ANGELINA-W_(VERO13) Eff.92.4%
Lamps: 1 x VERO13_(BXRC-30E2000C) 922.394lm@250mA CCT=3000K P=8 I=250mA

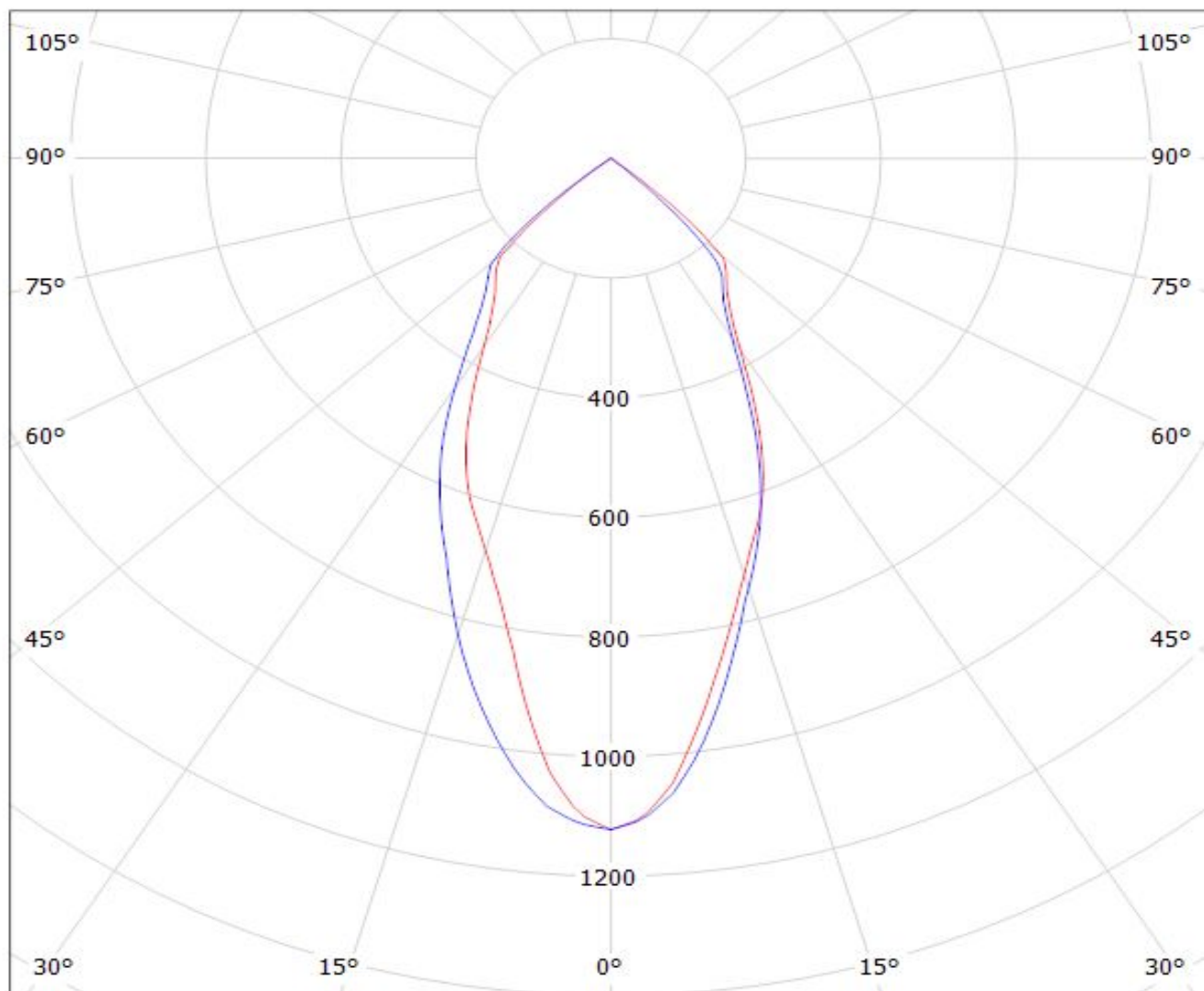

cd/klm

— C0 - C180

— C90 - C270

$\eta = 92\%$

Luminaire: LEDiL Oy FCN13696 ANGELINA-W (VERO18) Eff.91,7%
Lamps: 1 x VERO18_(BXRC-30E4000F) 906.273lm@250mA CCT=3000K P=7 I=250mA

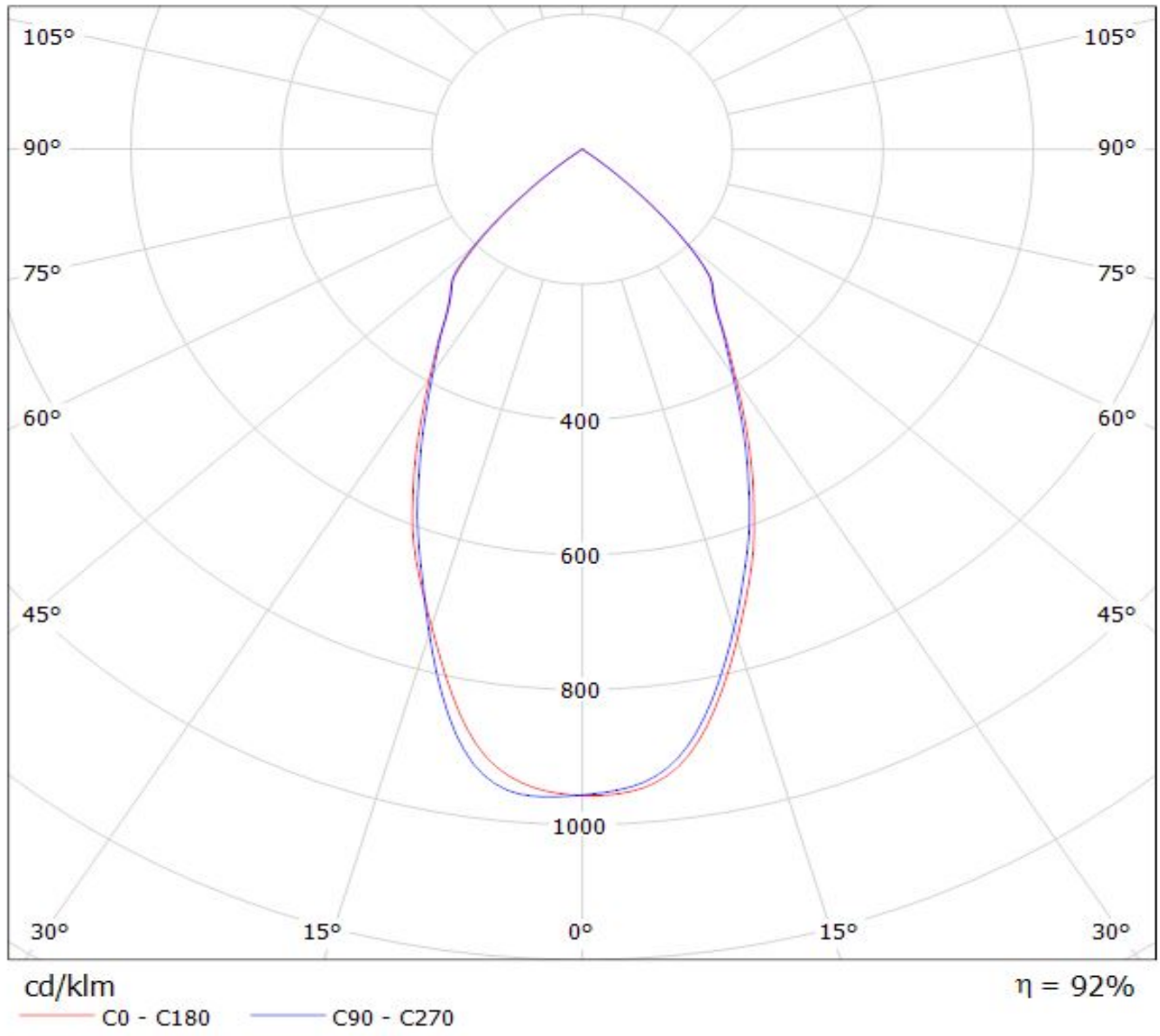

Luminaire: Ledil Oy FCN13696_ANGELINA-W+_B+W_434_TypL1_BRIDGELUX_V10_Gen7_SIMULATED
Lamps: 1 x BRIDGELUX V10 Gen7

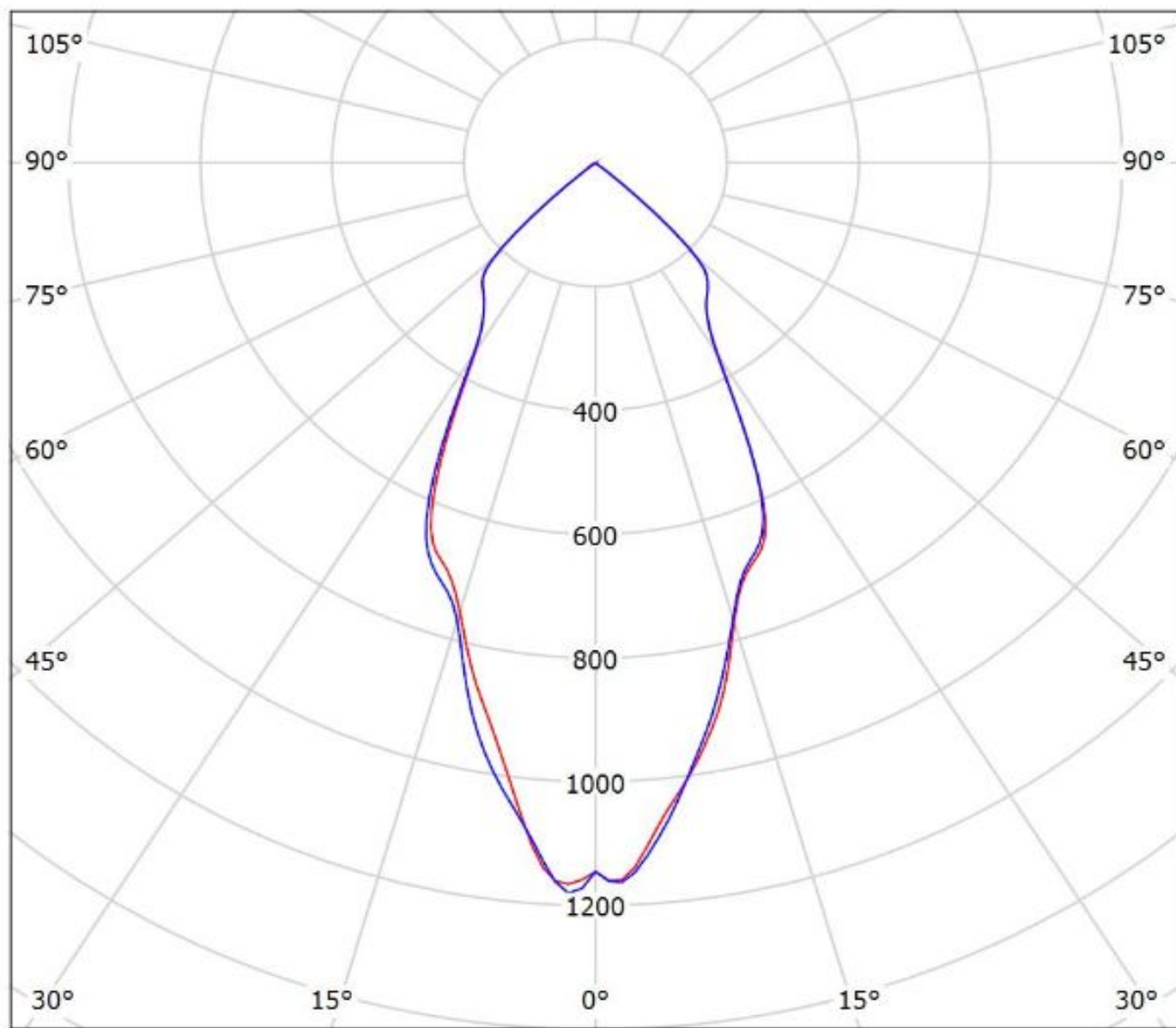

cd/klm

— C0 - C180 — C90 - C270

$\eta = 93\%$

Luminaire: Ledil FCN13696_ANGELINA-W_(CLU034)_ (433_Typ_L1)_ (C13658) Citizen_CLU034_(CLU034-1205B8-303M1A2)_ 1180.79lm@250mA_P=8.50075W_I=0.25A
Lamps: 1 x Citizen_CLU034_(433_Typ_L1)_ (C13658)_ 1173.16lm@250mA_P=8.475W_I=0.25A

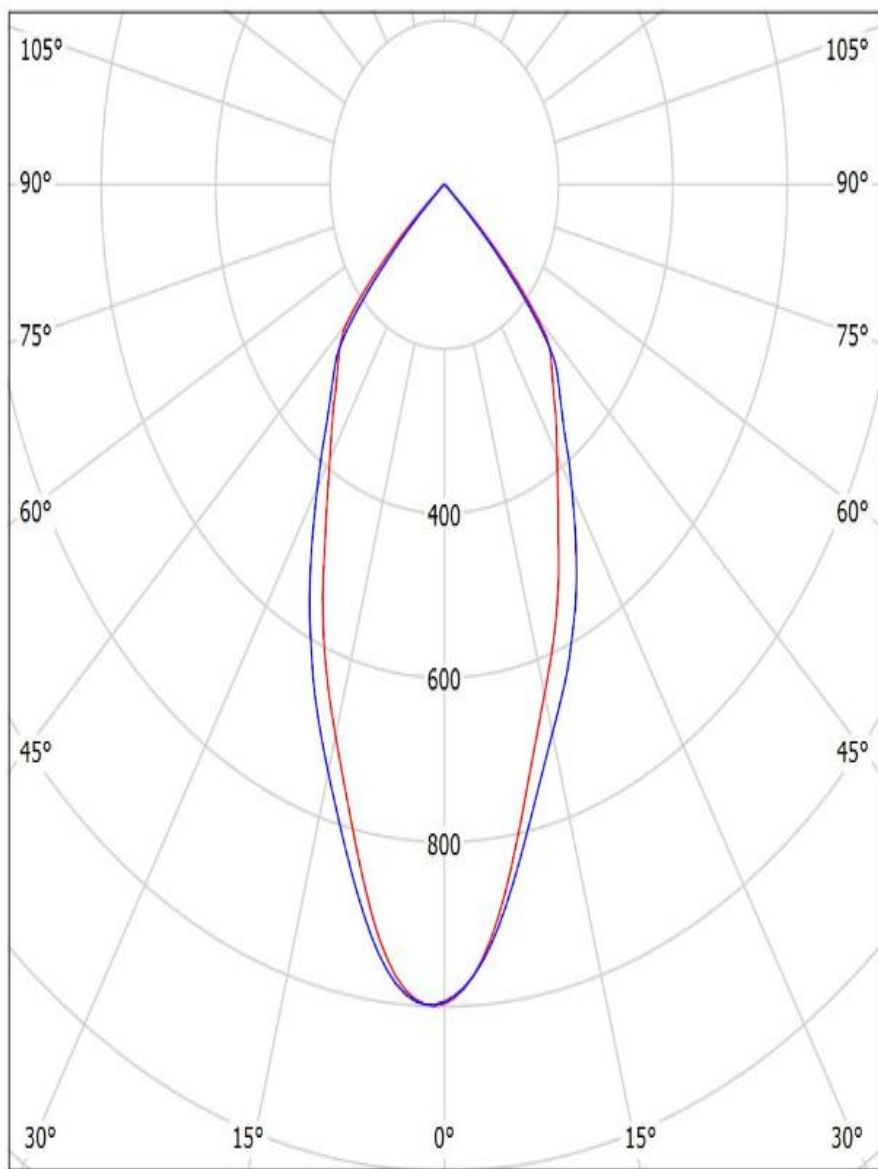

cd/klm

— C0 - C180 — C90 - C270

$\eta = 92\%$

Luminaire: Ledil FCN13696_ANGELINA-W_(CLU700)_ (434_Typ_L1) Citizen_CLU700_(CLU700-1002B8-273M2G1)_390.128lm@100mA_P=3W_I=0.10A
Lamps: 1 x Citizen_CLU700_(CLU700-1002B8-273M2G1)_388.036lm@100mA_P=3W_I=0.10A

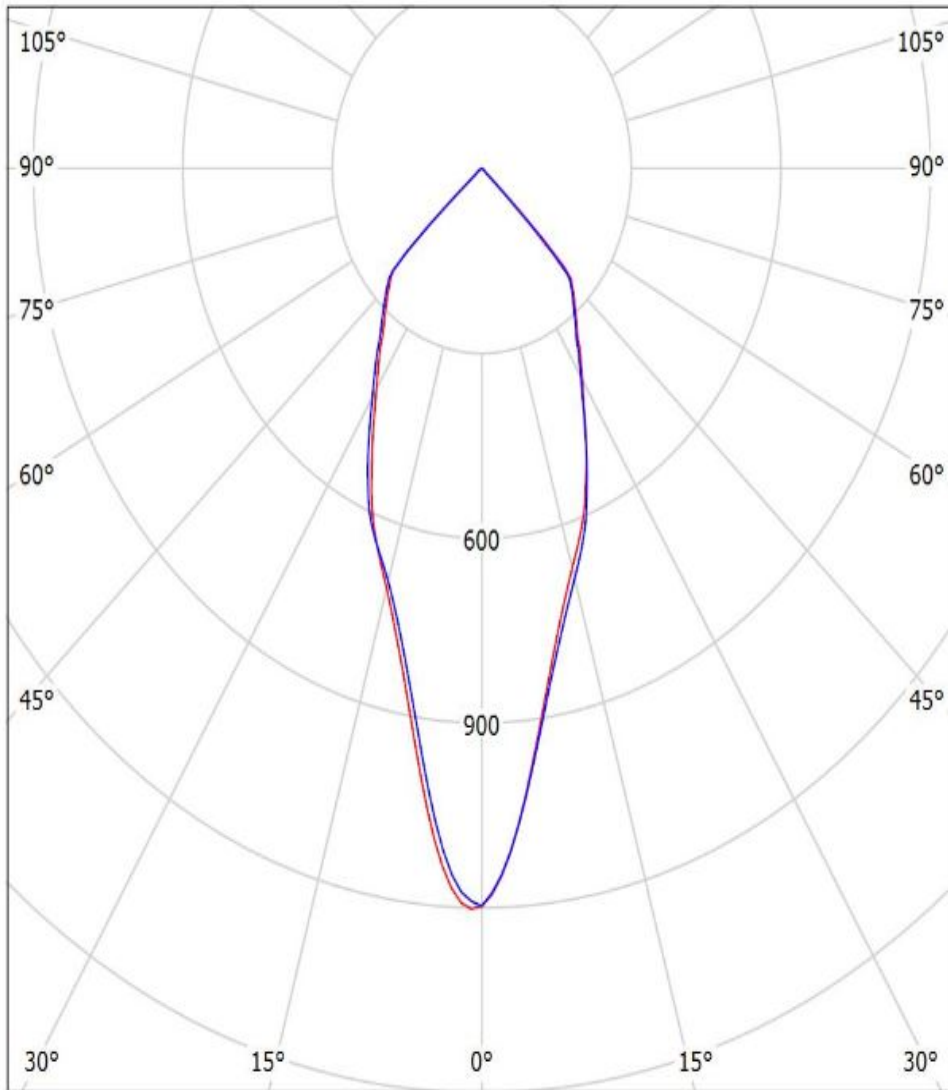

cd/klm

— C0 - C180 — C90 - C270

$\eta = 92\%$