



Chipsmall Limited consists of a professional team with an average of over 10 year of expertise in the distribution of electronic components. Based in Hongkong, we have already established firm and mutual-benefit business relationships with customers from,Europe,America and south Asia,supplying obsolete and hard-to-find components to meet their specific needs.

With the principle of "Quality Parts,Customers Priority,Honest Operation,and Considerate Service",our business mainly focus on the distribution of electronic components. Line cards we deal with include Microchip,ALPS,ROHM,Xilinx,Pulse,ON,Everlight and Freescale. Main products comprise IC,Modules,Potentiometer,IC Socket,Relay,Connector.Our parts cover such applications as commercial,industrial, and automotives areas.

We are looking forward to setting up business relationship with you and hope to provide you with the best service and solution. Let us make a better world for our industry!



Contact us

Tel: +86-755-8981 8866 Fax: +86-755-8427 6832

Email & Skype: info@chipsmall.com Web: www.chipsmall.com

Address: A1208, Overseas Decoration Building, #122 Zhenhua RD., Futian, Shenzhen, China



DETAILS

Product Number	FCN13705_ANGELA-S
Family	ANGELA
Type	RefPack
Color	metal
Diameter	119,5 mm
Height	79,31 mm
Style	round
Optic Material	
Holder Material	
Fastening	
Status	production ready
ROHS Compliant	Yes
Date Updated	3/11/2016



OPTICAL PROPERTIES

LED	Viewing Angle	Light Beam	Efficiency	cd/lm	Connector
VERO13	8 deg	Spot	94 %	22.480	LEDiL: LEDiL
VERO18	12 deg	Spot	93 %	11.000	LEDiL: LEDiL
V15 Gen6	10 deg	Spot	92 %	15.300	Bender Wirth: 456 Typ L2
V10 Gen7	sim: 10	Spot	sim: 91 %	sim: 15.300	Bender Wirth: 434 Typ L1
CLU720/721	7 deg	Spot	88 %	26.100	Bender Wirth: 433 Typ L1
CLL03x/CLU03x	10 deg	Spot	88 %	15.000	Bender Wirth: 433 Typ L1
CLU700/701	5 deg	Spot	88 %	57.800	Bender Wirth: 434 Typ L1
CLL02x/CLU02x (LES10)	6 deg	Spot	90 %	34.100	Bender Wirth: 434 Typ L1
CXA/B 1816 & CXA/B 1820 & CXA 1850	8 deg	Spot	89 %	22.600	Bender Wirth: 437 Typ L1
CXA/B 15xx	5.8 deg	Spot	92 %	37.600	Bender Wirth: 441 Typ L1
LUXEON CoB 1202/1203	6 deg	Spot	91 %	36.000	Bender Wirth: 438 Typ L1
CXM-14	sim: 10	Spot	sim: 88 %	sim: 15.000	Bender Wirth: 433 Typ L1
CXM-9	sim: 6	Spot	sim: 90 %	sim: 34.100	Bender Wirth: 434 Typ L1
COB L-Type (LES 9)	6 deg	Spot	93 %	39.000	Bender Wirth: 438 Typ L1
COB J-Type	9 deg	Spot	89 %	15.200	Bender Wirth: 463 Typ L2
COB L-Type (LES 11)	7 deg	Spot	89 %	24.300	Bender Wirth: 438 Typ L1
Soleriq P13	9 deg	Spot	94 %	17.000	Bender Wirth: 437 Typ L1
Soleriq S13	8 deg	Spot	89 %	21.000	Bender Wirth: 437 Typ L1
LC026B/LC040B	11 deg	Spot	8 %	10.700	Bender Wirth: 450 Typ L2
ZC12/18	sim: 10	Spot	sim: 88 %	sim: 15.000	Bender Wirth: 433 Typ L1
ZC4/6	sim: 6	Spot	sim: 90 %	sim: 34.100	Bender Wirth: 434 Typ L1
SLE G5 LES11	7 deg	Spot	91 %	30.100	Bender Wirth: 434 Typ L1

Relative intensity of FCN13705_ANGELA-S_(V15)

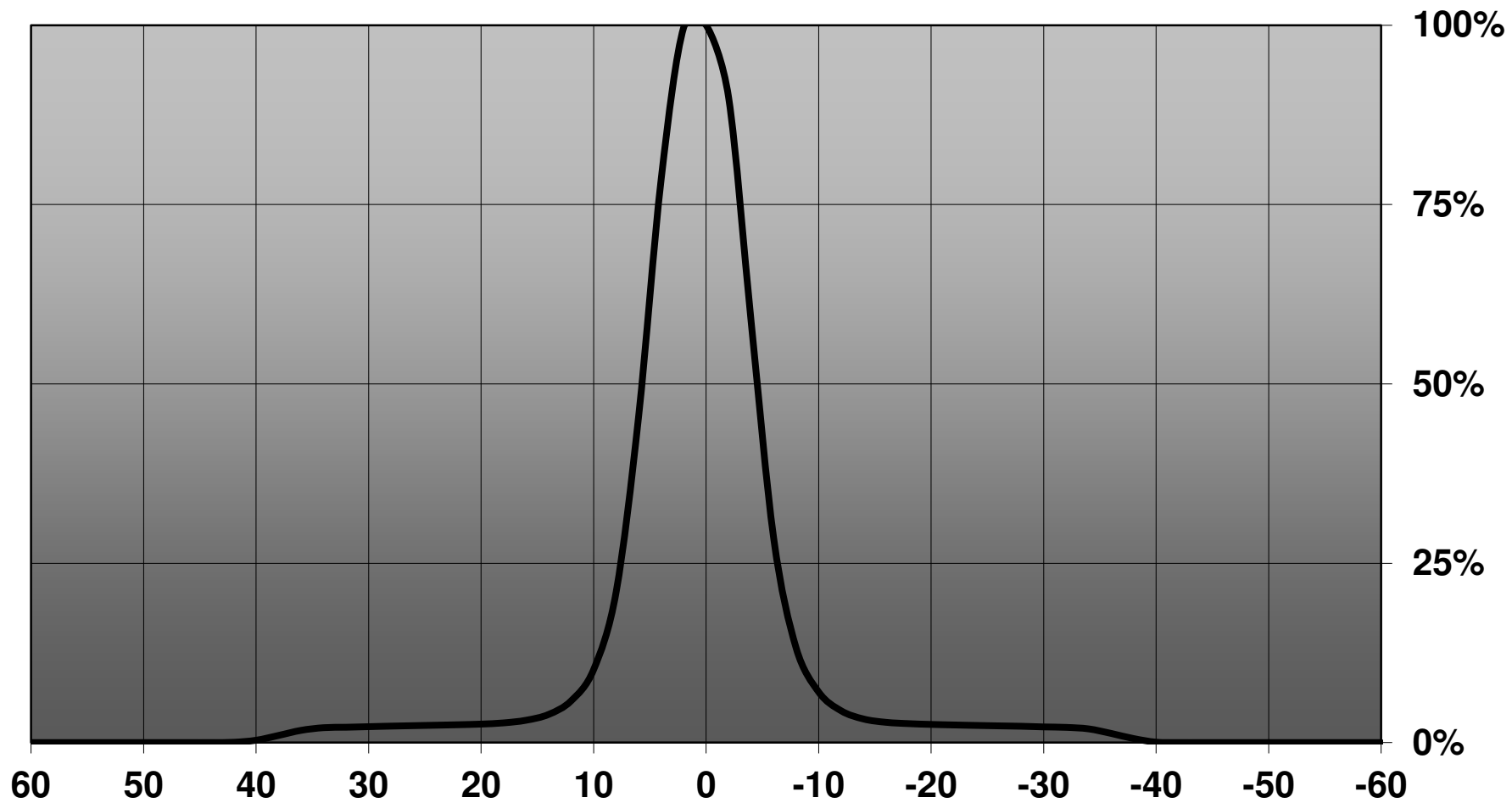

H G F E D C B A

4
3
2
1

4
3
2
1

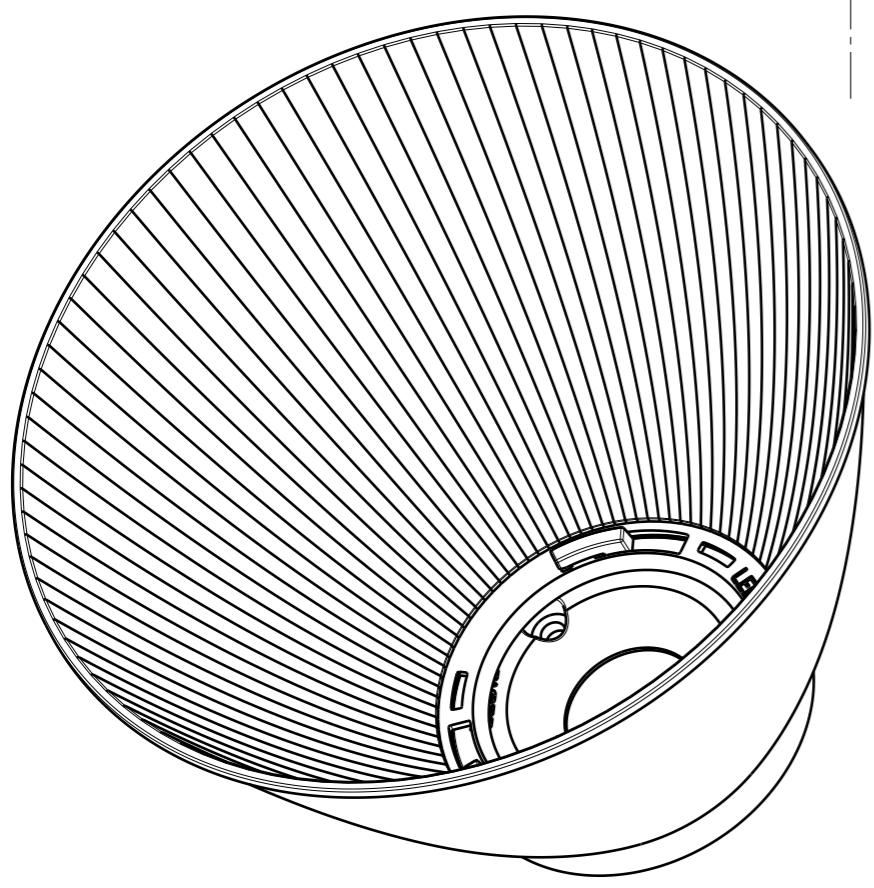
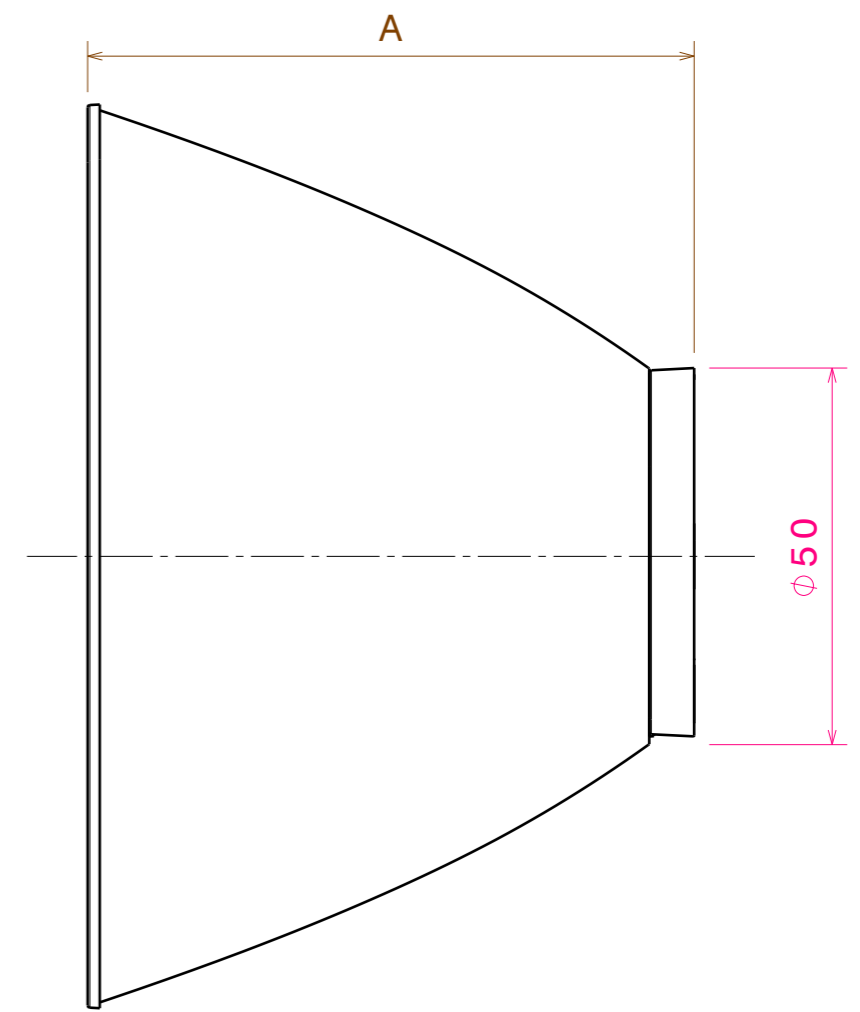
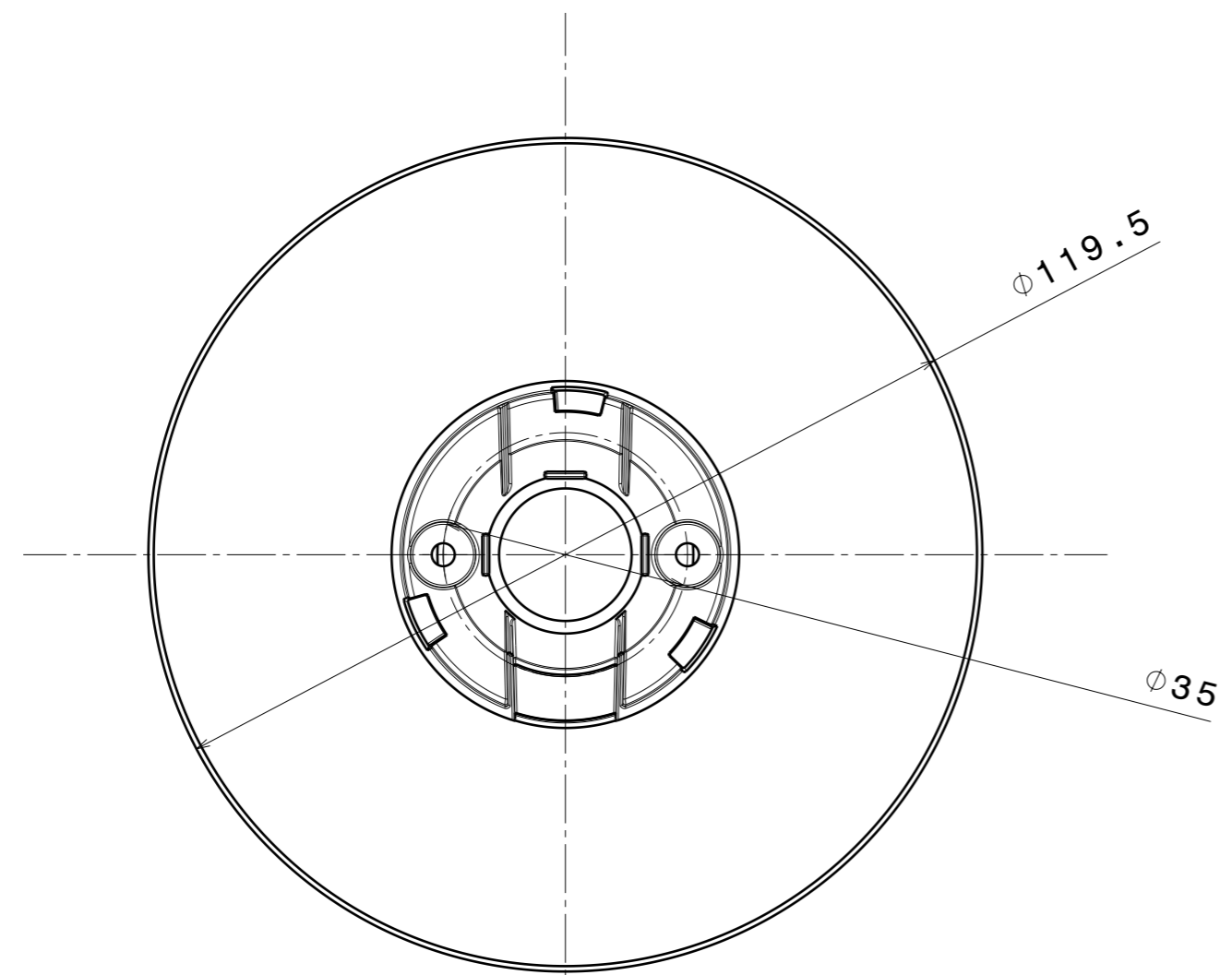

	DIMENSION A
WITH LEDIL LUXEON S SOCKETS	80.5 mm
WITH TYCO SOCKET	80.5 mm
WITH LEDIL BRIDGELUX VERO SOCKETS 13-18	79.5 mm

Tolerances if not otherwise shown
According to DIN ISO 2768-1
Linear measures:
Up to 30mm class M, otherwise class C.
According to DIN ISO 2768-2
Form and position: class L

LEDiL Ledil Oy
Salorankatu 10
FIN 24240 SALO
Finland

THIRD ANGLE PROJECTION:

DRAWING TITLE
DATA SHEET ANGELA

This drawing is the property of LEDiL Oy. It may not be reproduced, copied or communicated without a written agreement with LEDiL Oy."

SIZE	PART NUMBER
A3	-

SCALE	1:1	WEIGHT	-	SHEET	1/1
-------	-----	--------	---	-------	-----

H G B A

Luminaire: LEDiL Oy FCN13705_ANGELA-S_(VERO13)
Lamps: 1 x Bridgelux_VERO13_(BXRC-40E2000C)_1069.14lm@250mA_P=7.64944W_I=249.9mA

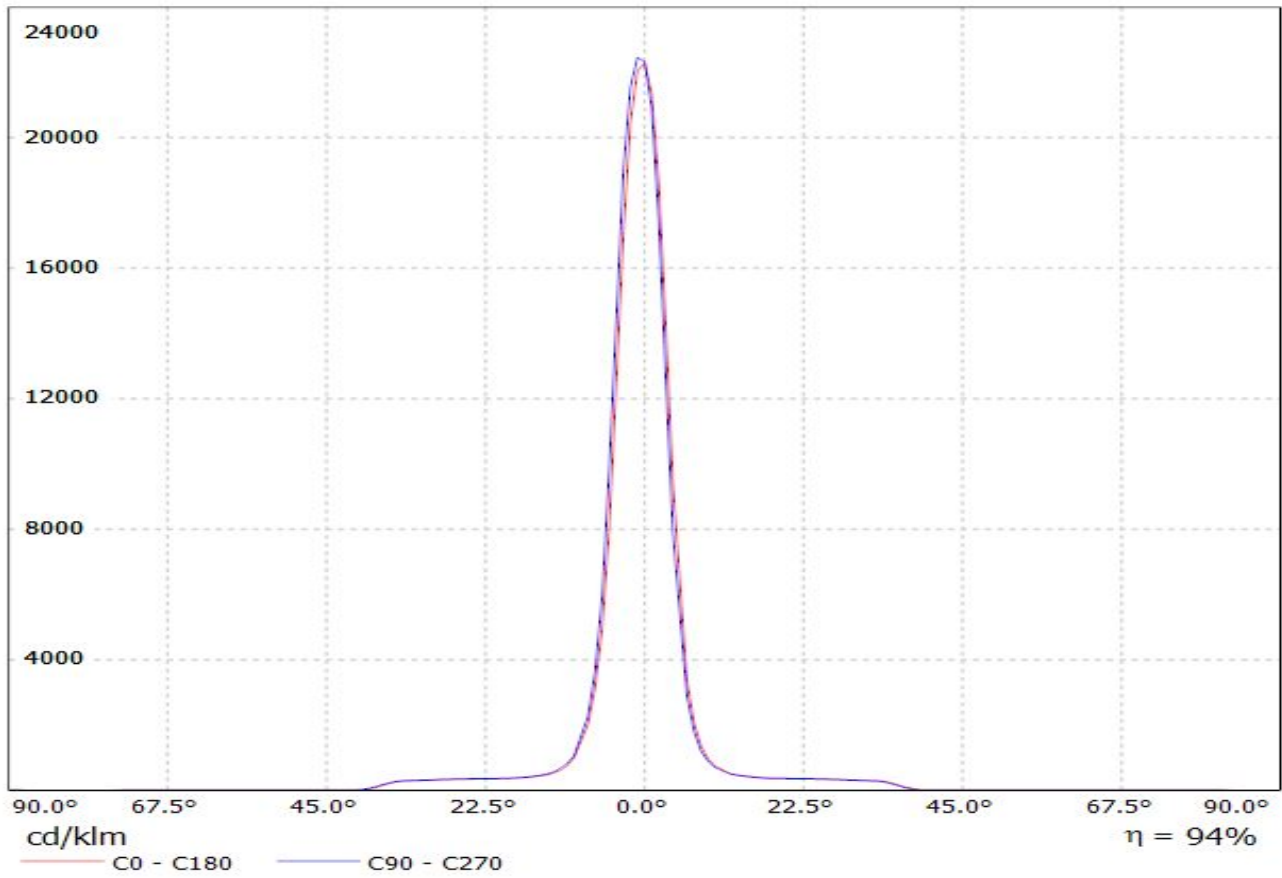

Luminaire: LEDiL Oy FCN13705_ANGELA-S_(VERO18) Eff.93.1%
Lamps: 1 x Bridgelux_VERO18_891.528lm@250mA_P=6.81802W_I=249.9mA

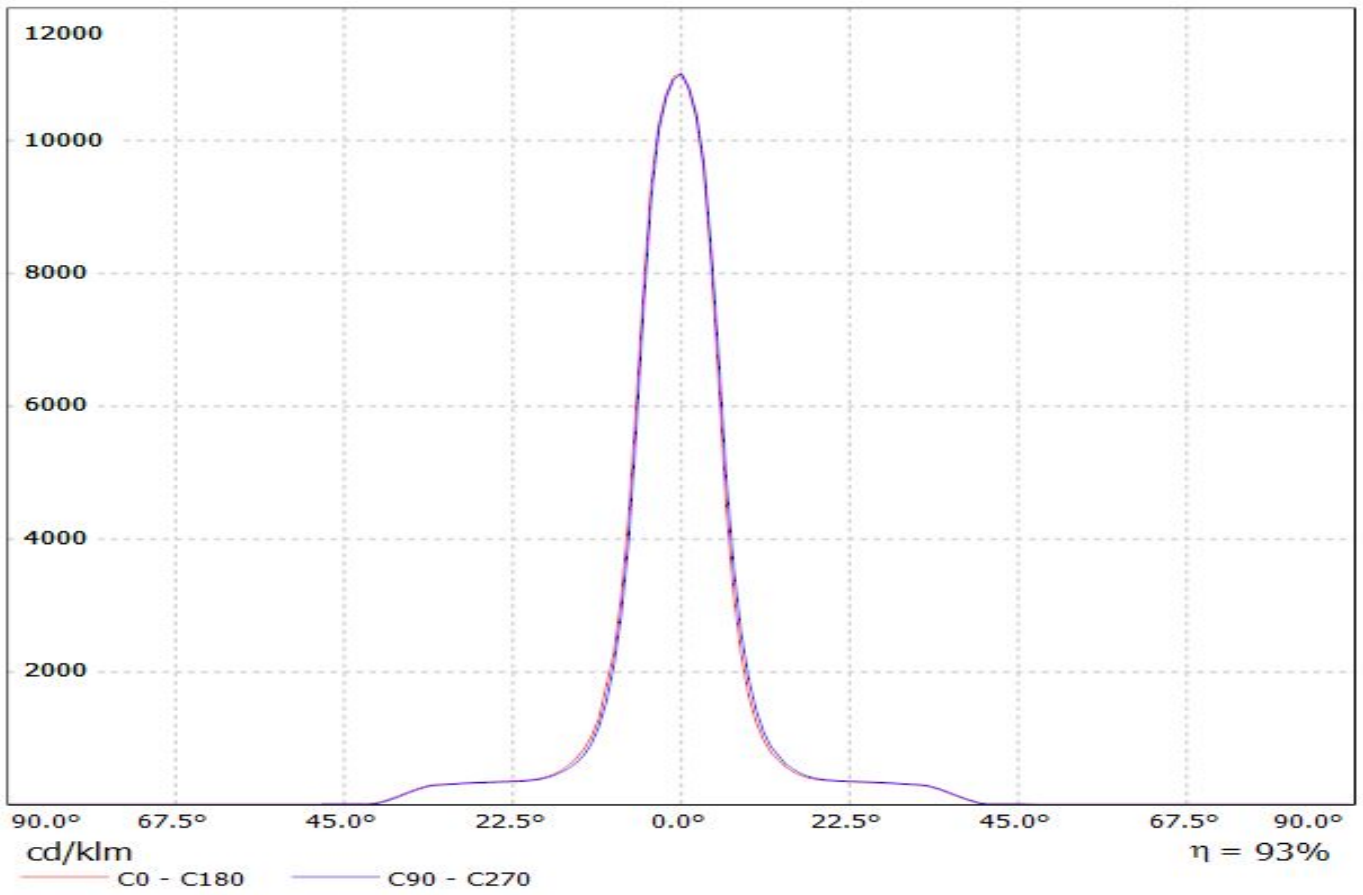

Luminaire: Ledil Oy FCN13705_ANGELA-S+_B+W_434_TypL1_BRIDGELUX_V10_Gen7_SIMULATED
Lamps: 1 x BRIDGELUX V10 Gen7

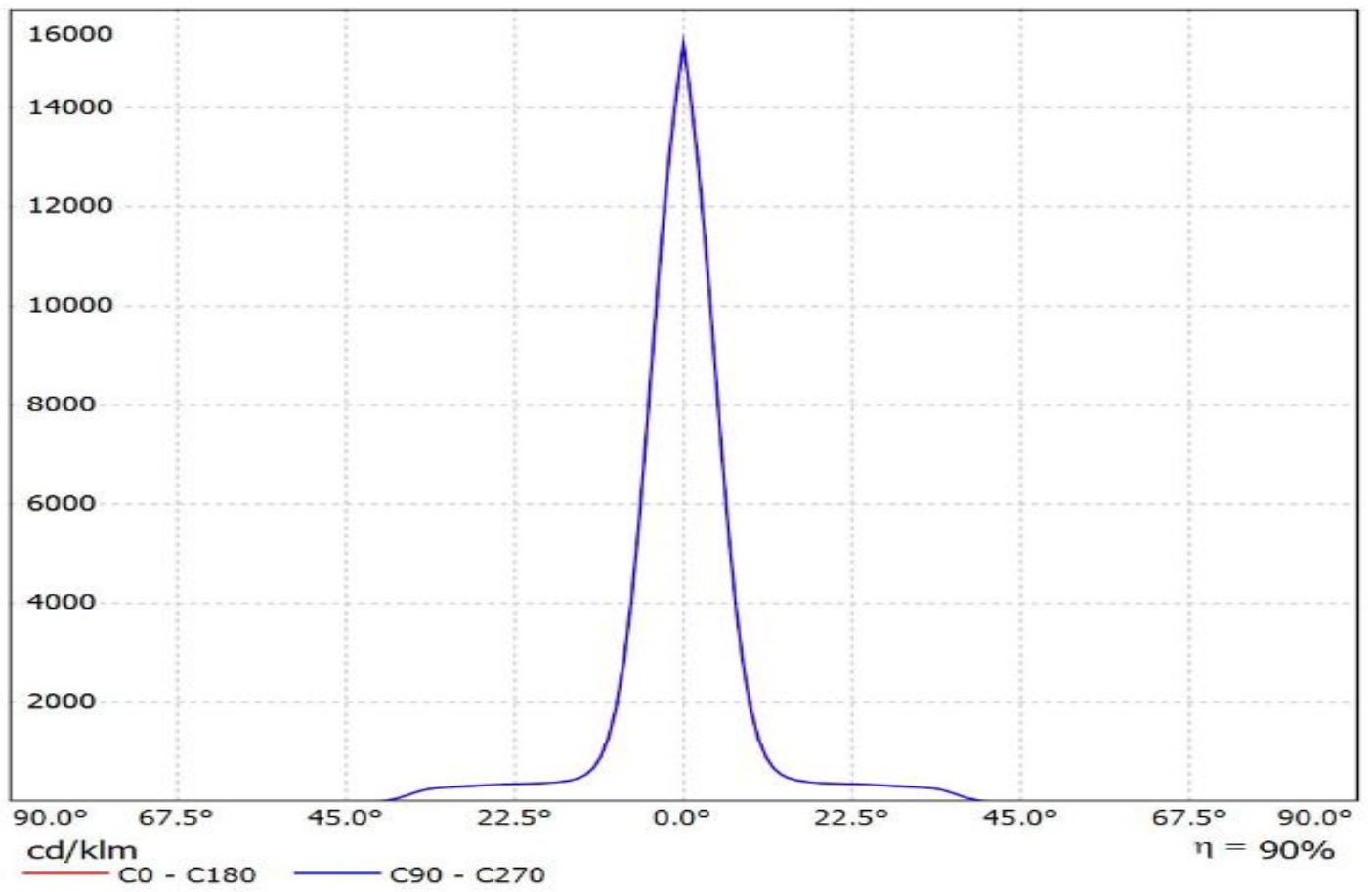

Ledil FCN13705_ANGELA-S_(CLU720)_(433_Typ_L1) / LDC (Linear)

Luminaire: Ledil FCN13705_ANGELA-S_(CLU720)_(433_Typ_L1)

Lamps: 1 x Citizen_CLU720_(CLU720-1206B8-273M2G1)_1225.89lm@250mA_P=8.3W_I=0.25A

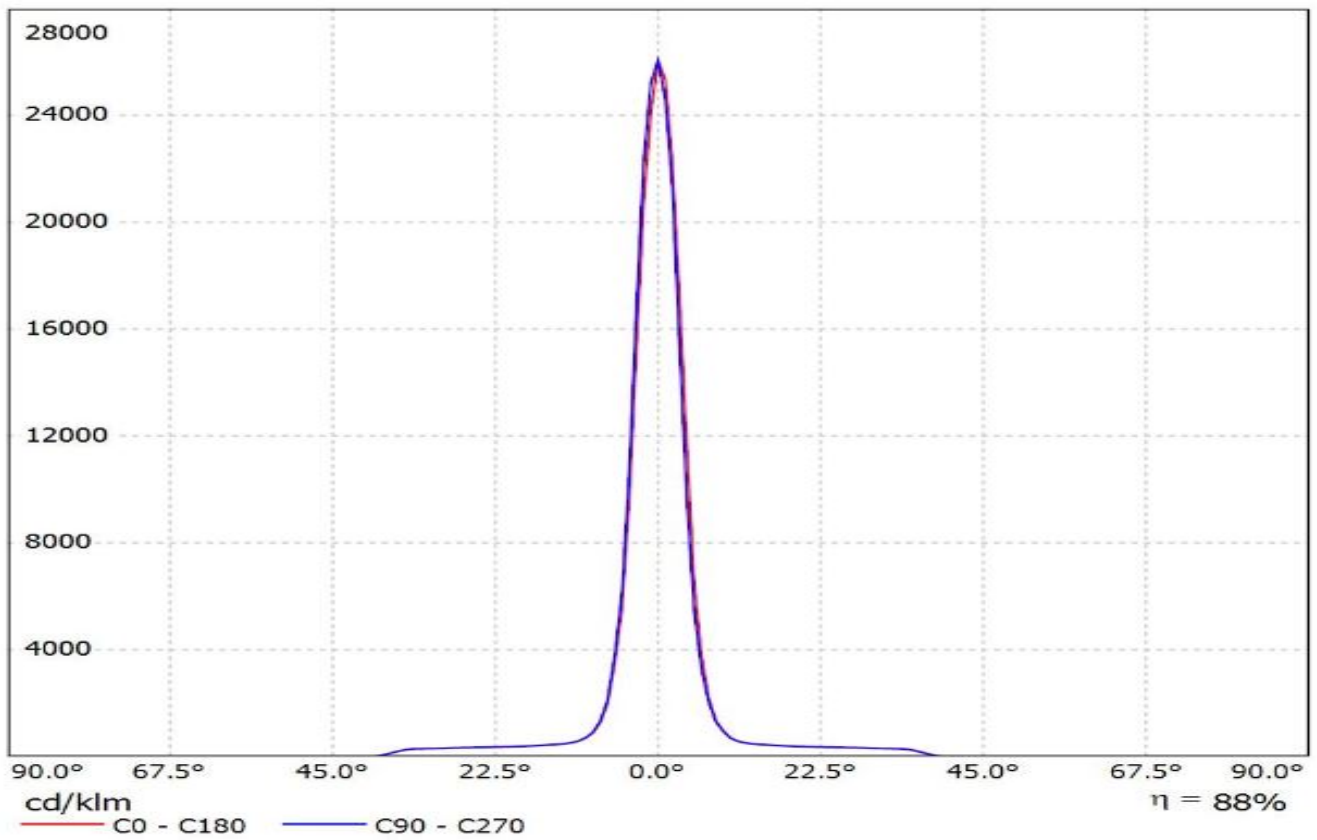

Luminaire: Ledil FCN13705_ANGELA-S_(CLU034)_ (433_Typ_L1)_ (C13658) Citizen_CLU034_(CLU034-1205B8-303M1A2)_1180.79lm@250mA_P=8.50075W_I=0.25A
Lamps: 1 x Citizen_CLU034_(433_Typ_L1)_ (C13658)_1173.16lm@250mA_P=8.475W_I=0.25A

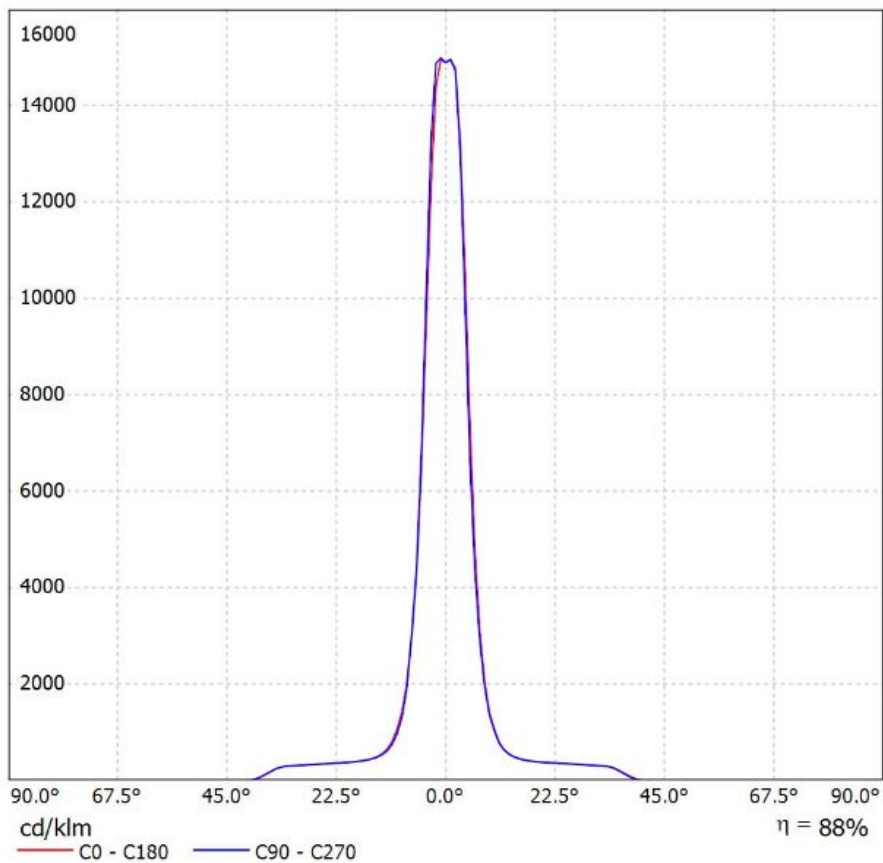

Luminaire: Ledil FCN13705_ANGELA-S_(CLU700)_434_Typ_L1 Citizen_CLU700_(CLU700-1002B8-273M2G1)_390.128lm@100mA_P=3W_I=0.10A
Lamps: 1 x Citizen_CLU700_(CLU700-1002B8-273M2G1)_388.036lm@100mA_P=3W_I=0.10A

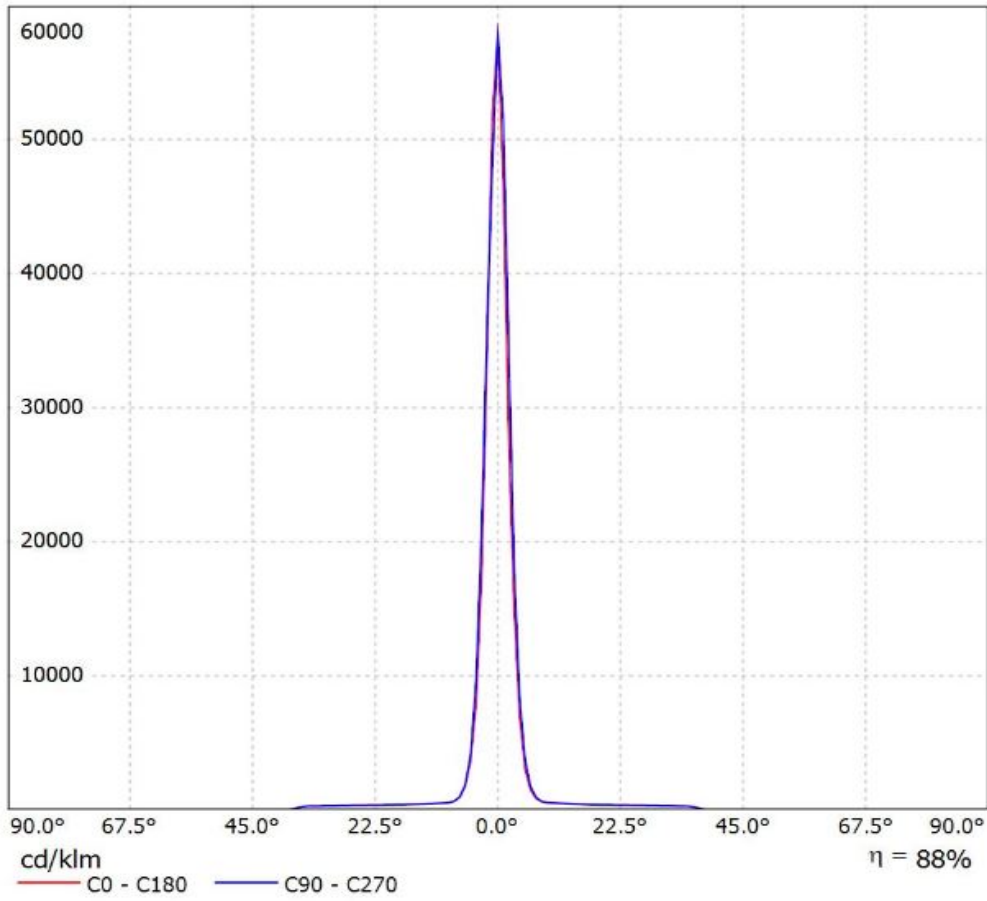

Luminaire: Ledil FCN13705_ANGELA-S_(CLU024) Citizen_CLU024_(434_Typ_L1)_(C13658_CLAMP-VERO13-18)_1077.47lm@250mA_P=8.57W_I=0.25A
Lamps: 1 x Citizen_CLU024_(434_Typ_L1)_(C13658_CLAMP-VERO13-18)_1077.47lm@250mA_P=8.57W_I=0.25A

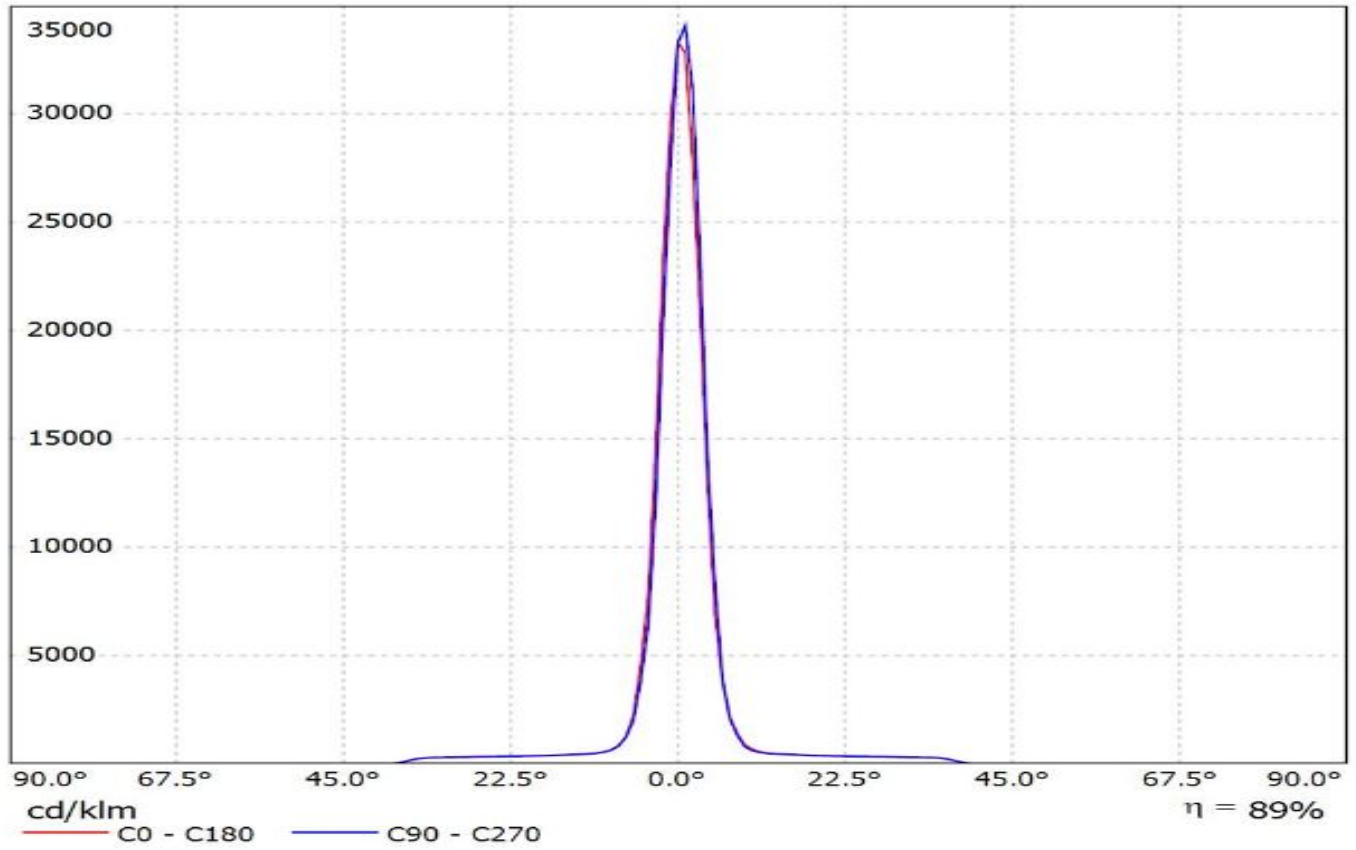

Luminaire: Ledil FCN13705_ANGELA-S_(CXA1850)

Lamps: 1 x CREE_CXA1850_(CXA1850-30F-T4-N0Y-00001)_831.914lm@250mA_CCT=3000K_P=8.27W_I=0.25A

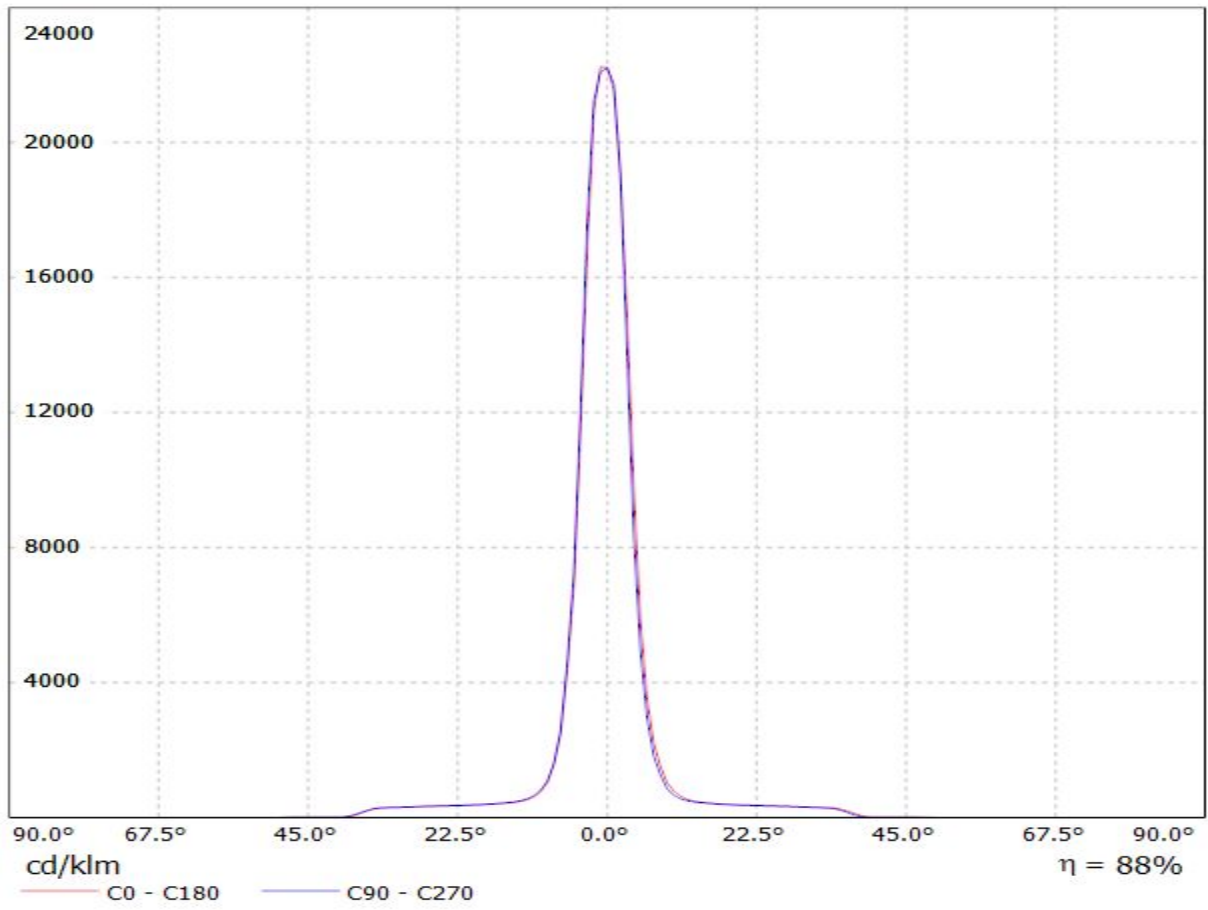

Luminaire: LEDiL Oy FCN13705_ANGELA-S_(CXA1520)_(441_Typ_L1)

Lamps: 1 x Cree_CXA1520_(CXA1520-30F-N4-00H-00001)_993.209lm@250mA_P=8.74575W_I=0.2499A

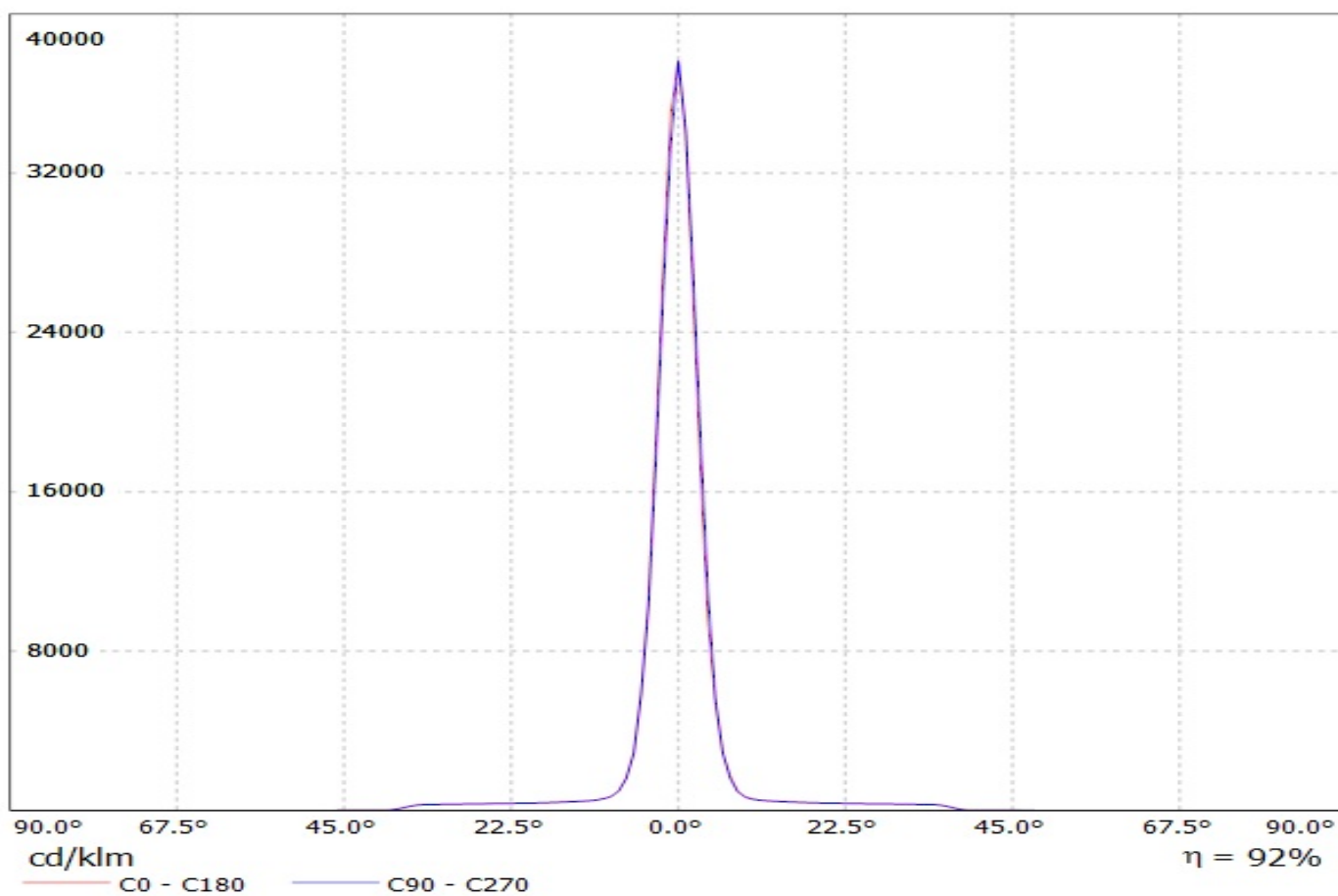

Luminaire: LEDiL Oy FCN13705_ANGELA-S_(LUXEON_CoB_1203)_ (438_Typ_L1)_ (C13658_CLAMP-VERO13-18)
Lamps: 1 x LUXEON_CoB_1203_(438_Typ_L1)_ (C13658_CLAMP-VERO13-18)_984.561lm@250mA_P=8.6828W_I=0.25A

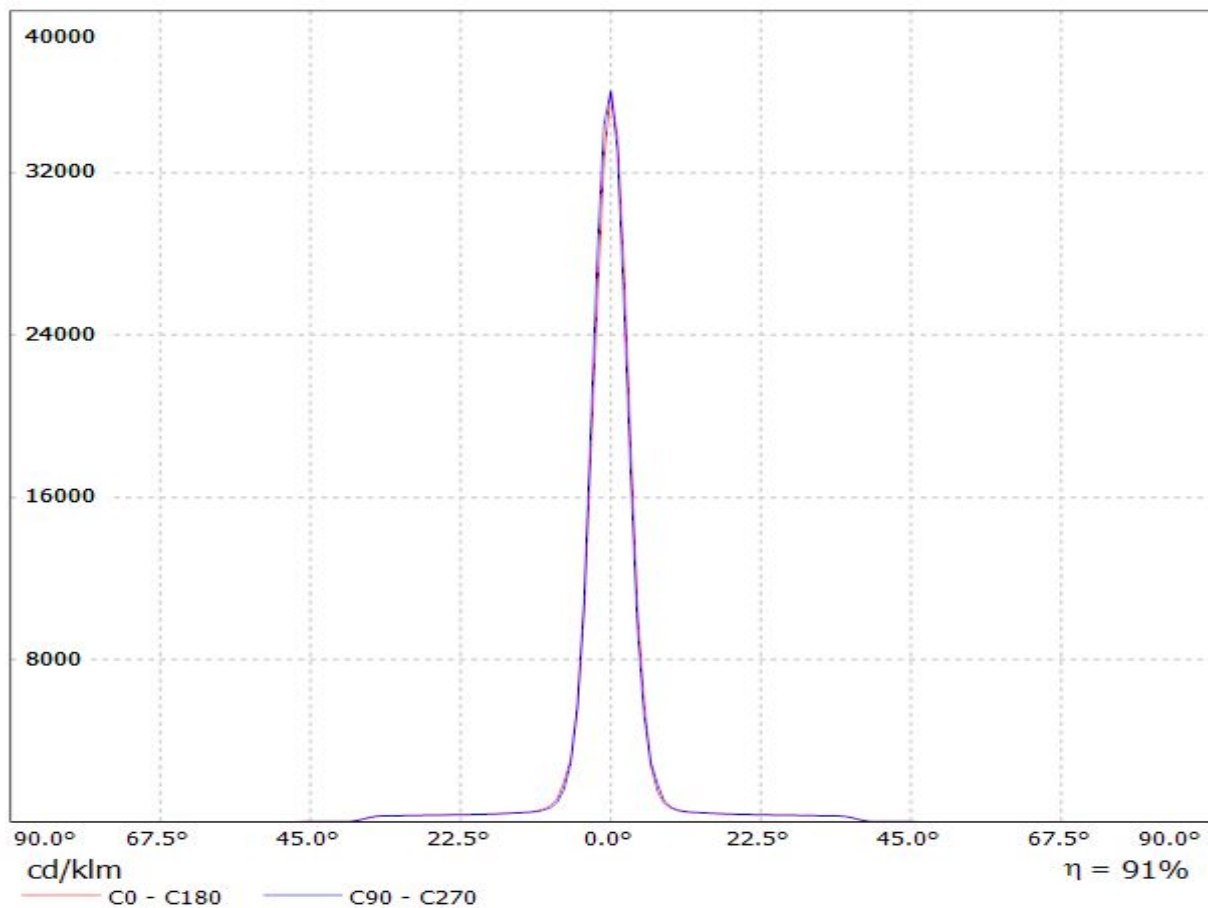

Luminaire: LEDiL Oy FCN13705_ANGELA-S_(NFCLL036B)

Lamps: 1 x Nichia NFCLL036B (sm403J1300R8000)_541.131lm@100mA_CCT=4000K_P=3.34324W_I=0.100A

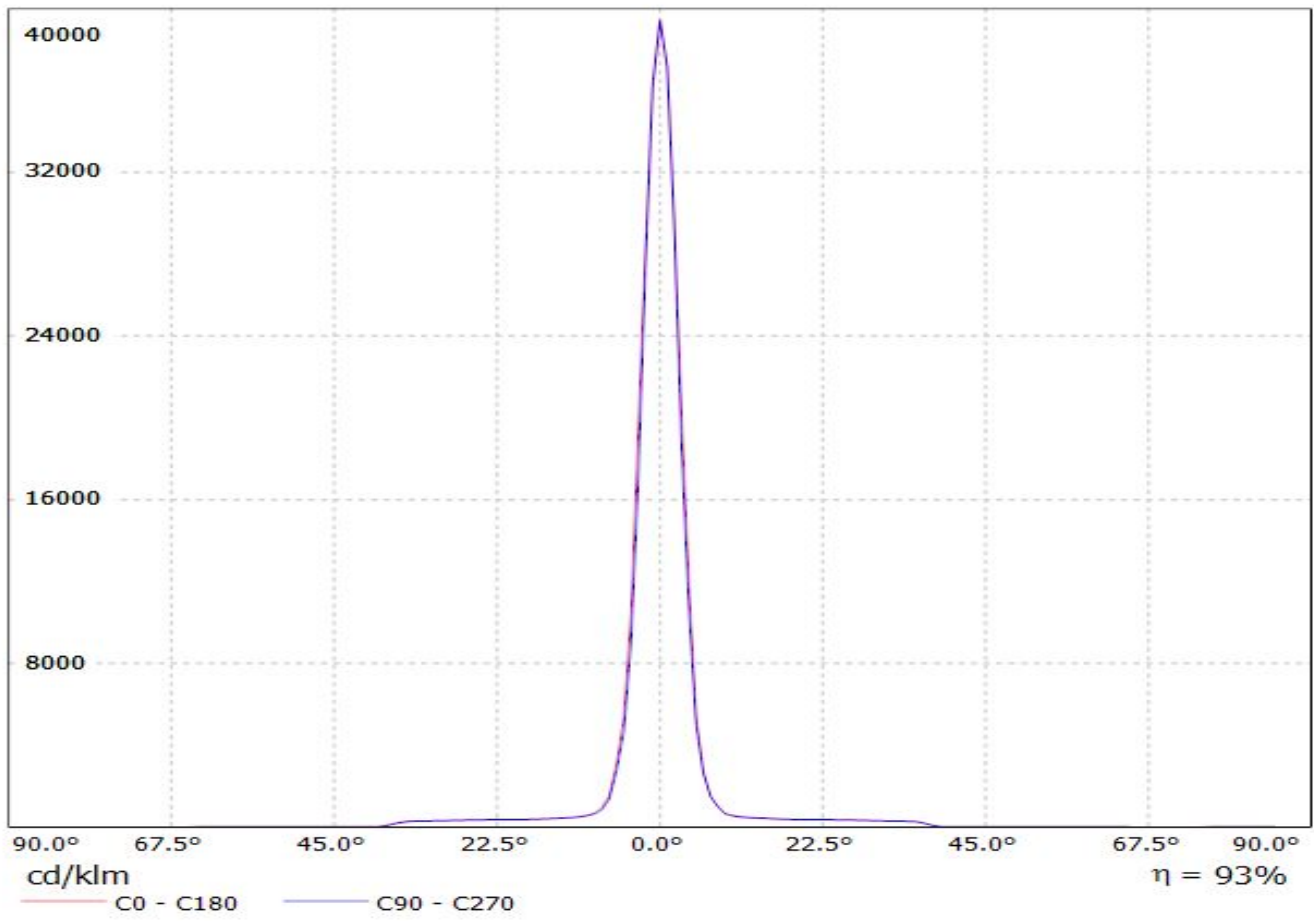

Luminaire: Ledil FCN13705_ANGELA-S_(NFDxJ130B)
Lamps: 1 x Nichia_NFDxJ130B_(463 Typ L2)_C13658_CLAMP-
VERO13_1504.8lm@250mA_P=8.27W_I=0.25A

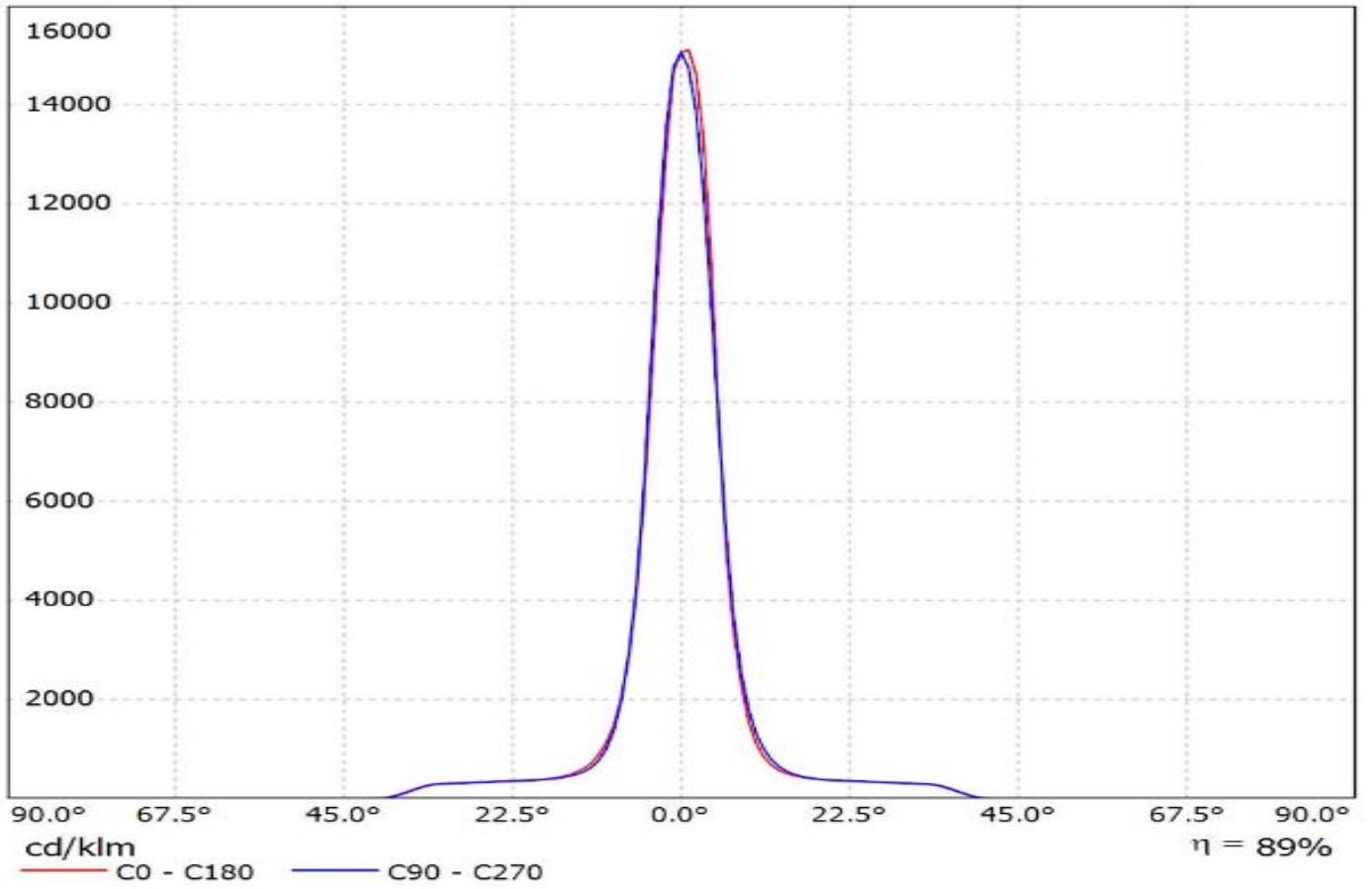

Luminaire: Ledil FCN13705_ANGELA-S_(NFCLL060B)

Lamps: 1 x Nichia_NFCLL060B_(438_TYP_L1)_C13658_1356.65lm@250mA_P=8.375W_I=0.25A

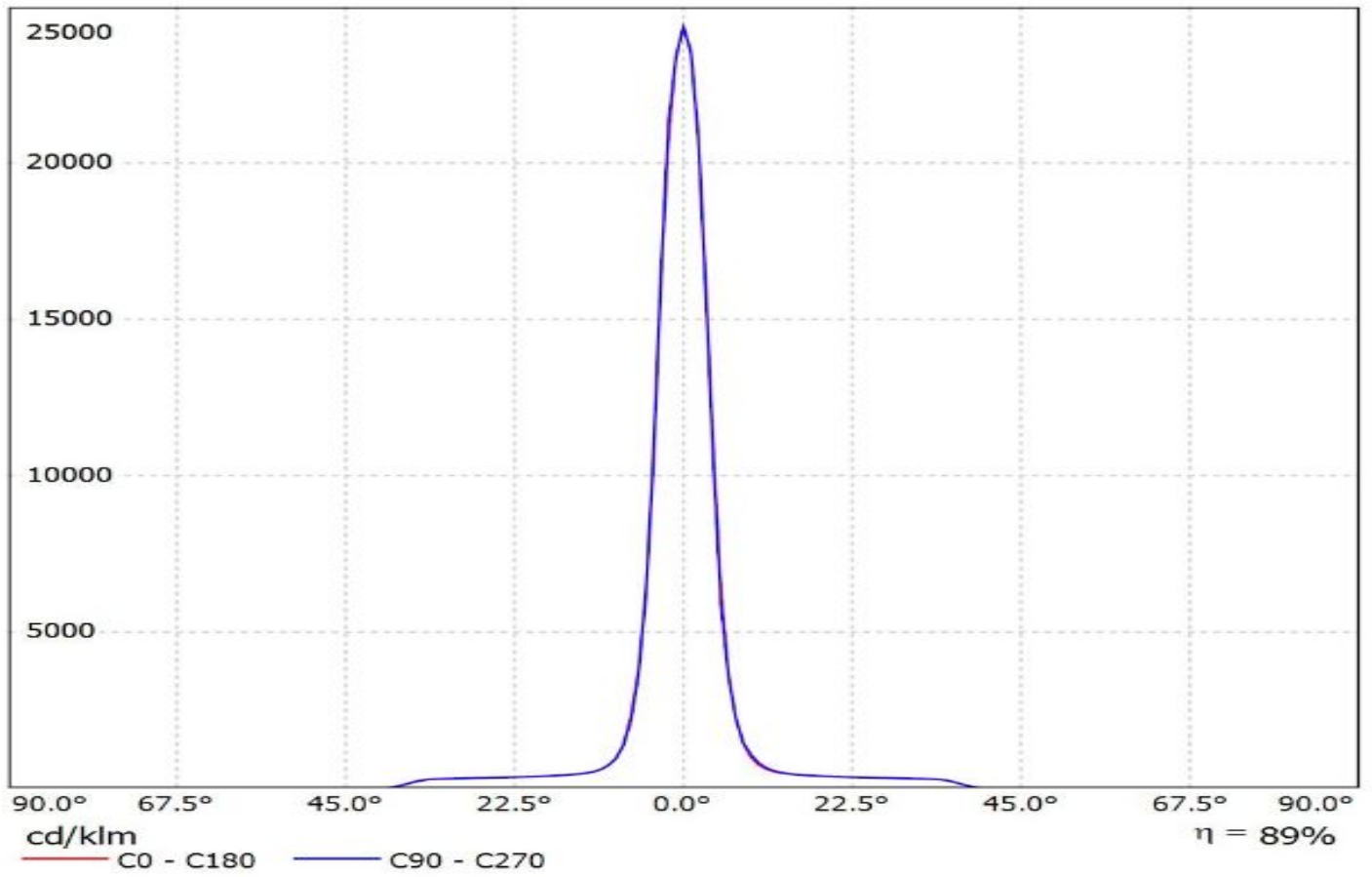

Luminaire: Ledil FCN13705_ANGELA-S_(Soleriq_P13)

Lamps: 1 x Osman_Soleriq_P13_1009.11lm@250mA_P=6.9385W_I=0.25A

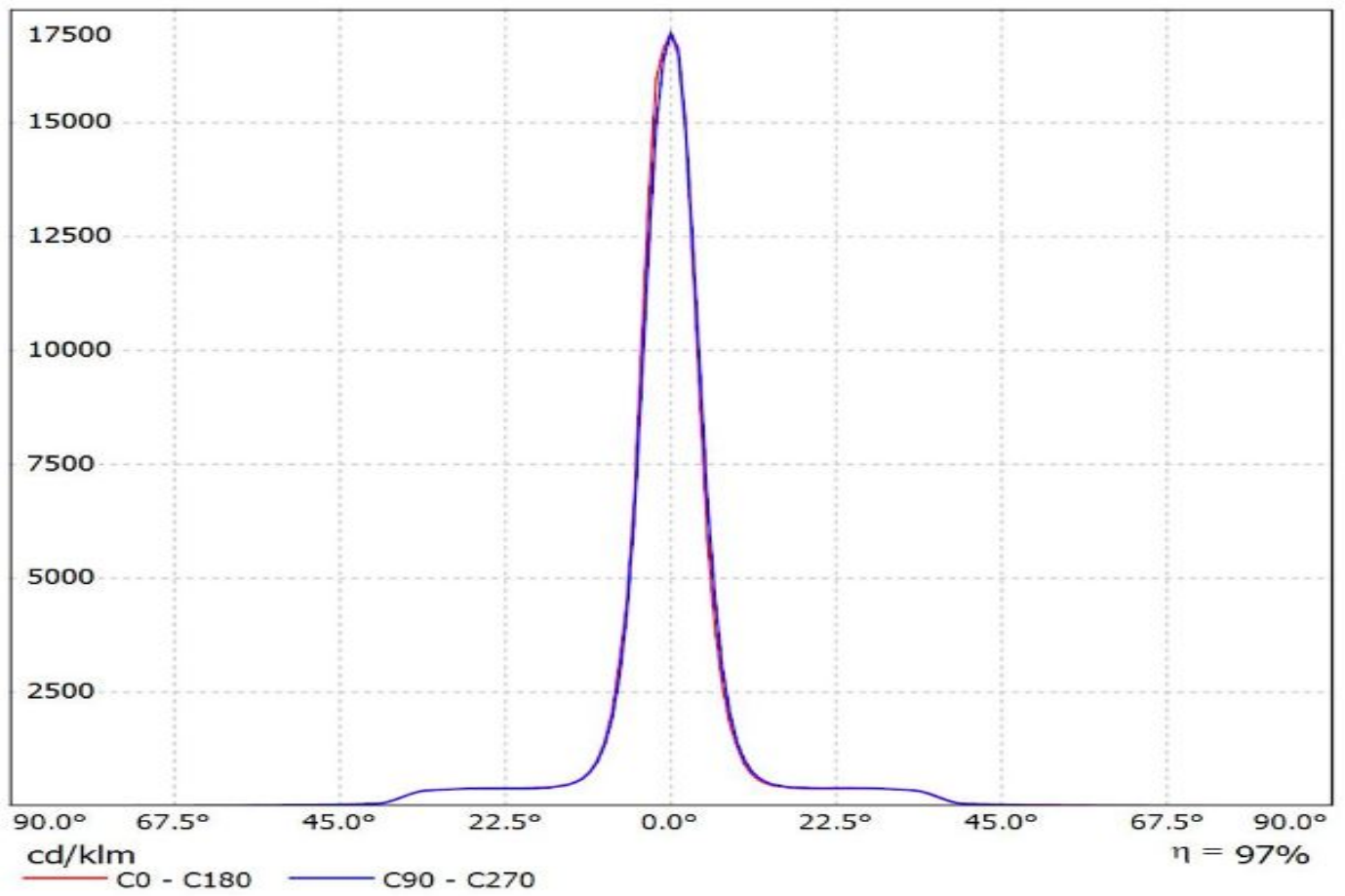

Ledil FCN13705_ANGELA-S_(Soleriq_S13) / LDC (Linear)

Luminaire: Ledil FCN13705_ANGELA-S_(Soleriq_S13)

Lamps: 1 x Osram_Soleriq_S13_(GW_KAGHB1.EM)_896.727lm@250mA_P=7.44679W_I=250mA

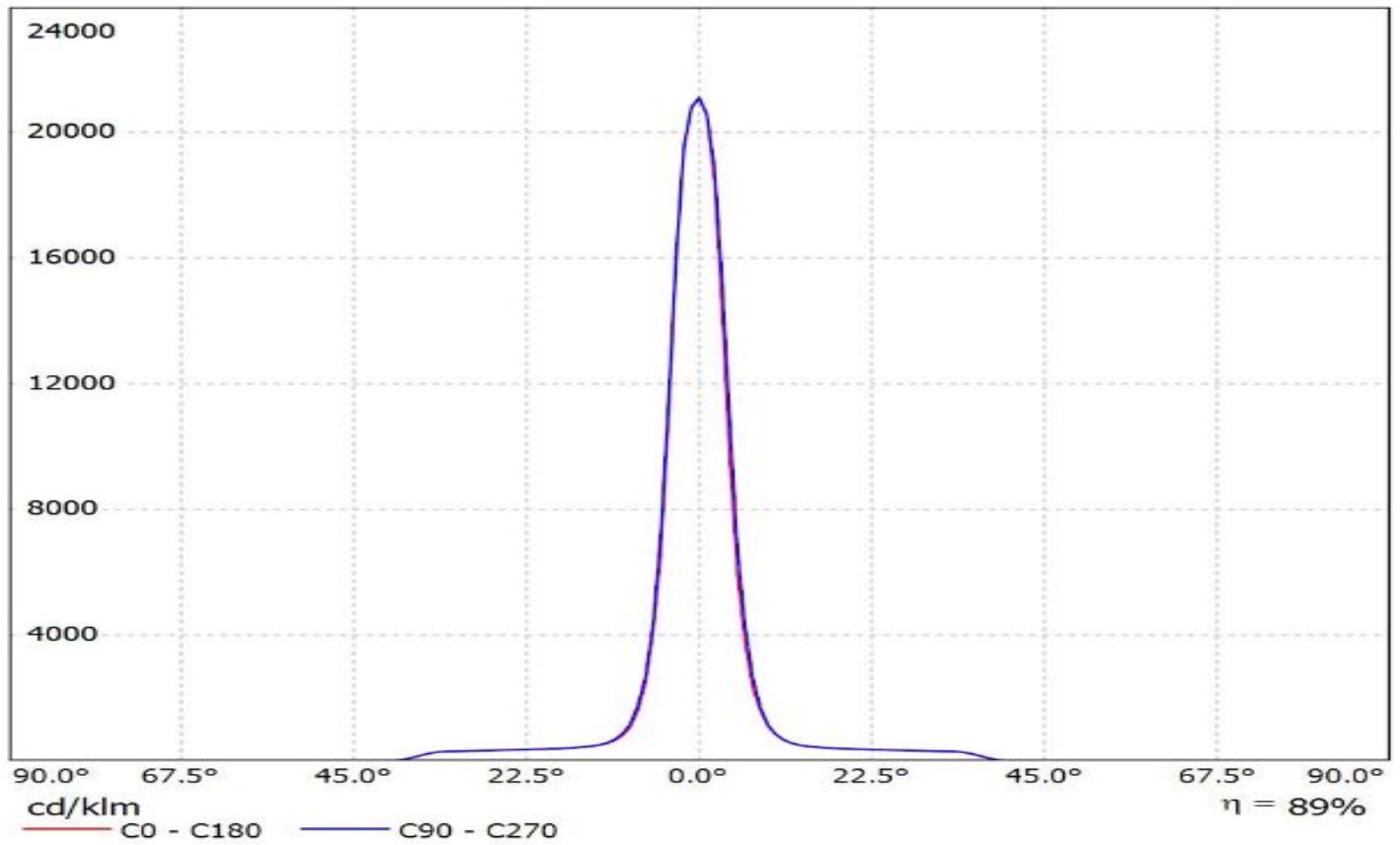

Luminaire: Ledil FCN13705_ANGELA-S (450_Typ_L2)_(C13658_CLAMP-VERO13-18)_(LC040B)
Lamps: 1 x Samsung LC040B CCT=3000K_(SPHWW1HDNE25010101)_(450_Typ_L2)_(C13658_CLAMP-VERO13-18)_1109.31lm@250mA_P=8.2W_I=0.25A

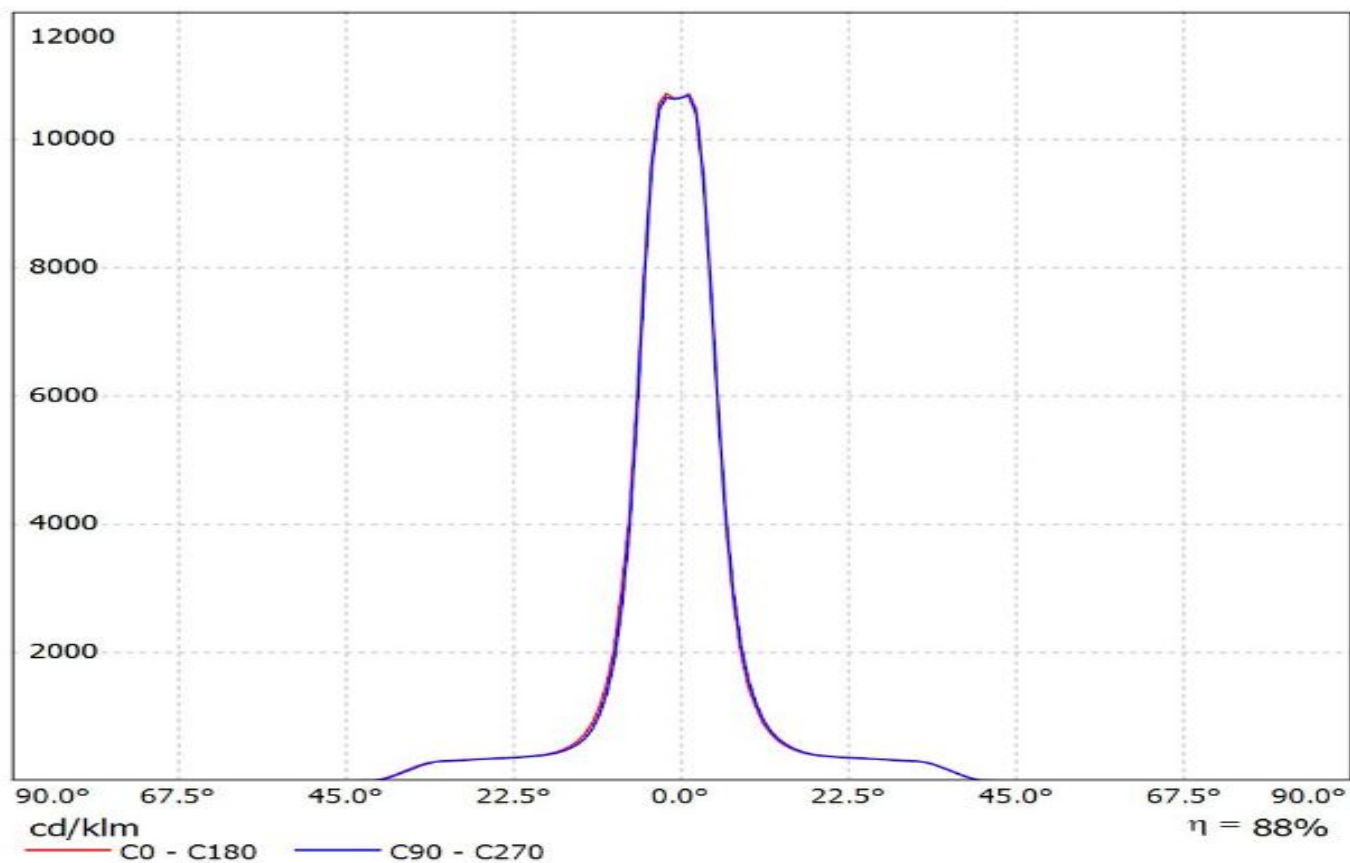

Luminaire: LEDiL Oy FCN13705_ANGELA-S_(SLE-G5_LES-11)
Lamps: 1 x Tridonic_SLE-G5_LES-11_1137.55lm@250mA_P=8.4177W_I=0.250A

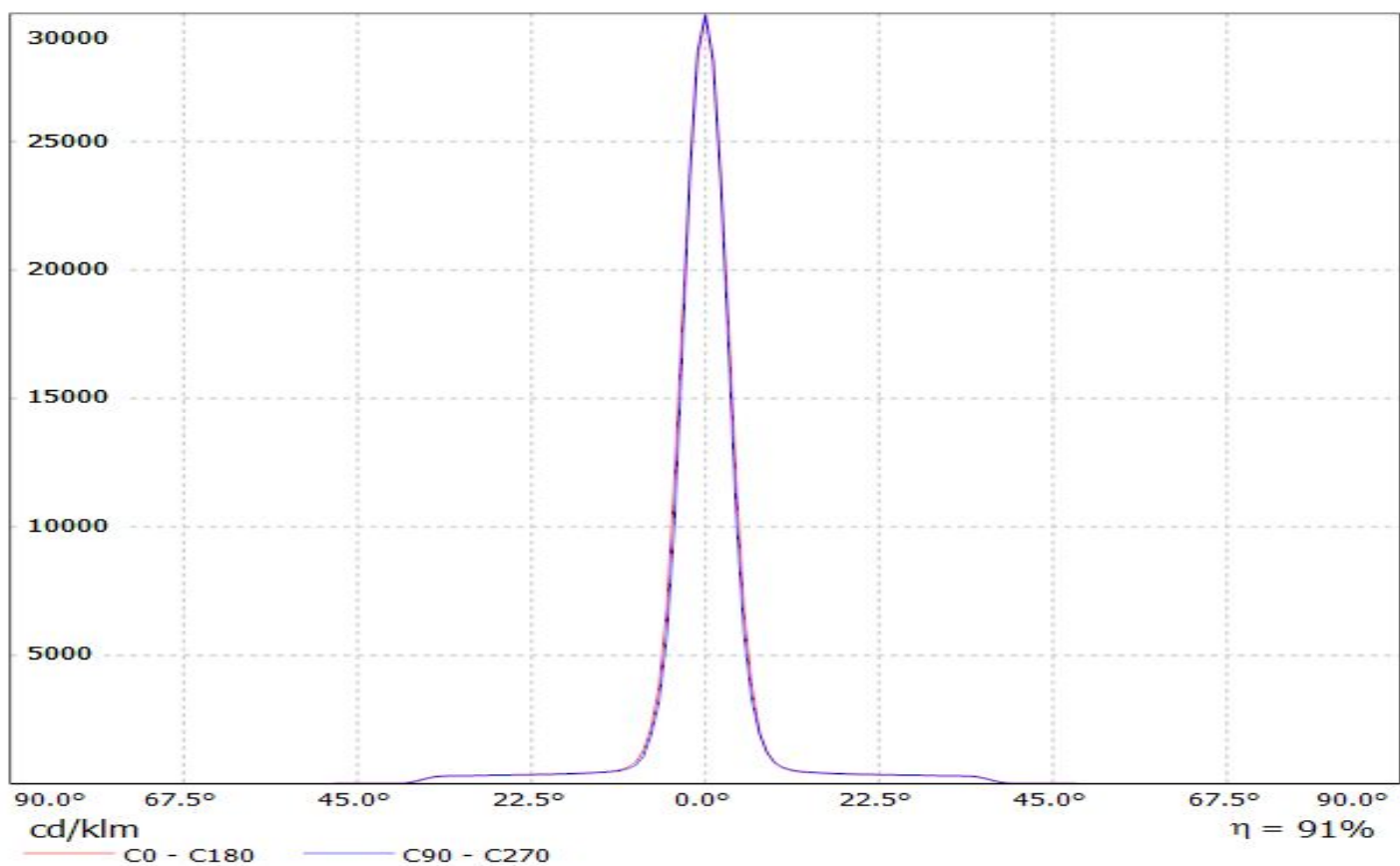

Luminaire: LEDiL Oy FCN13705_ANGELA-S_(VERO13)

Lamps: 1 x Bridgelux_VERO13_(BXRC-40E2000C)_1069.14lm@250mA_P=7.64944W_I=249.9mA

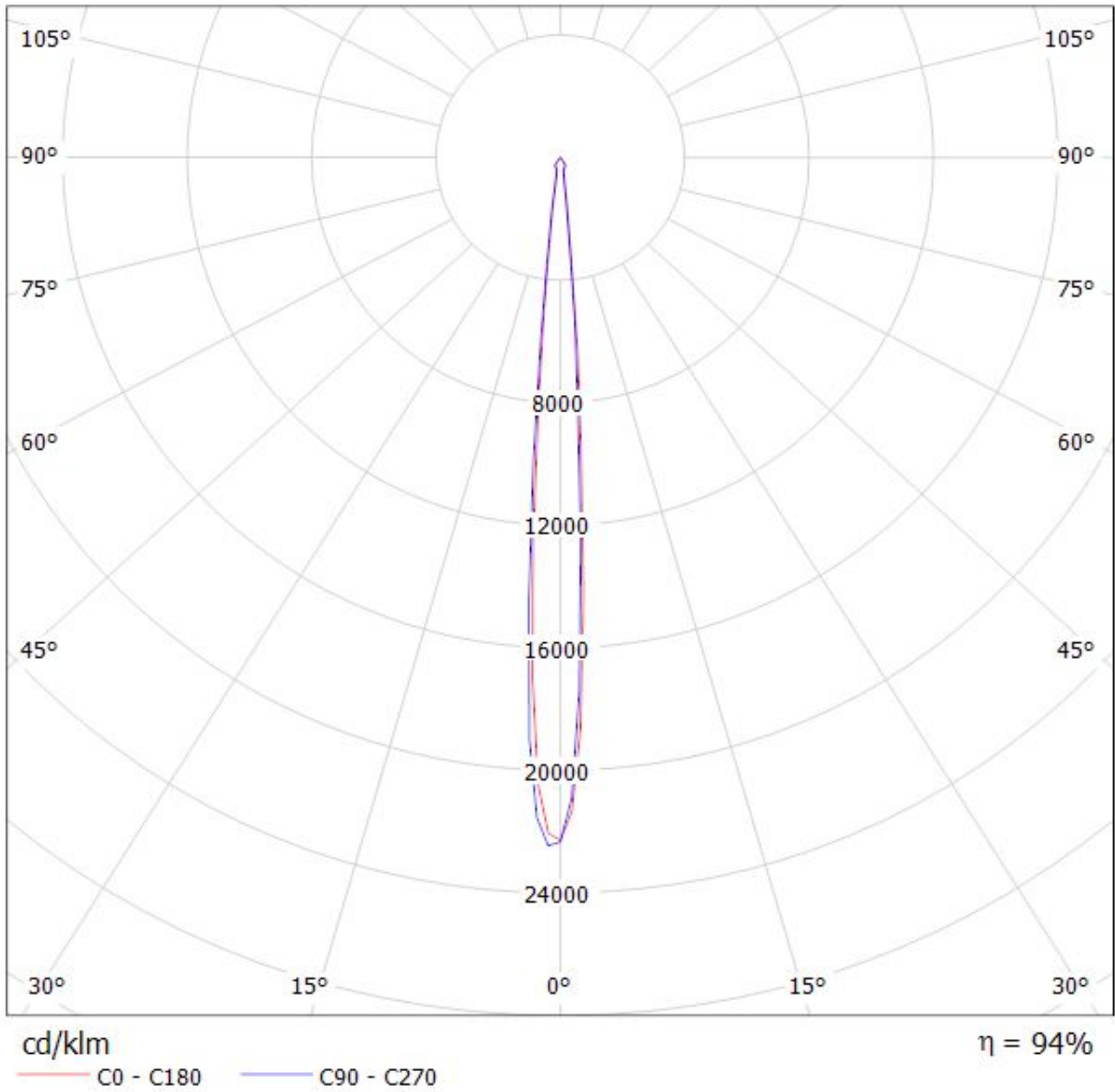

Luminaire: LEDiL Oy FCN13705_ANGELA-S_(VERO18) Eff.93.1%
Lamps: 1 x Bridgelux_VERO18_891.528lm@250mA_P=6.81802W_I=249.9mA

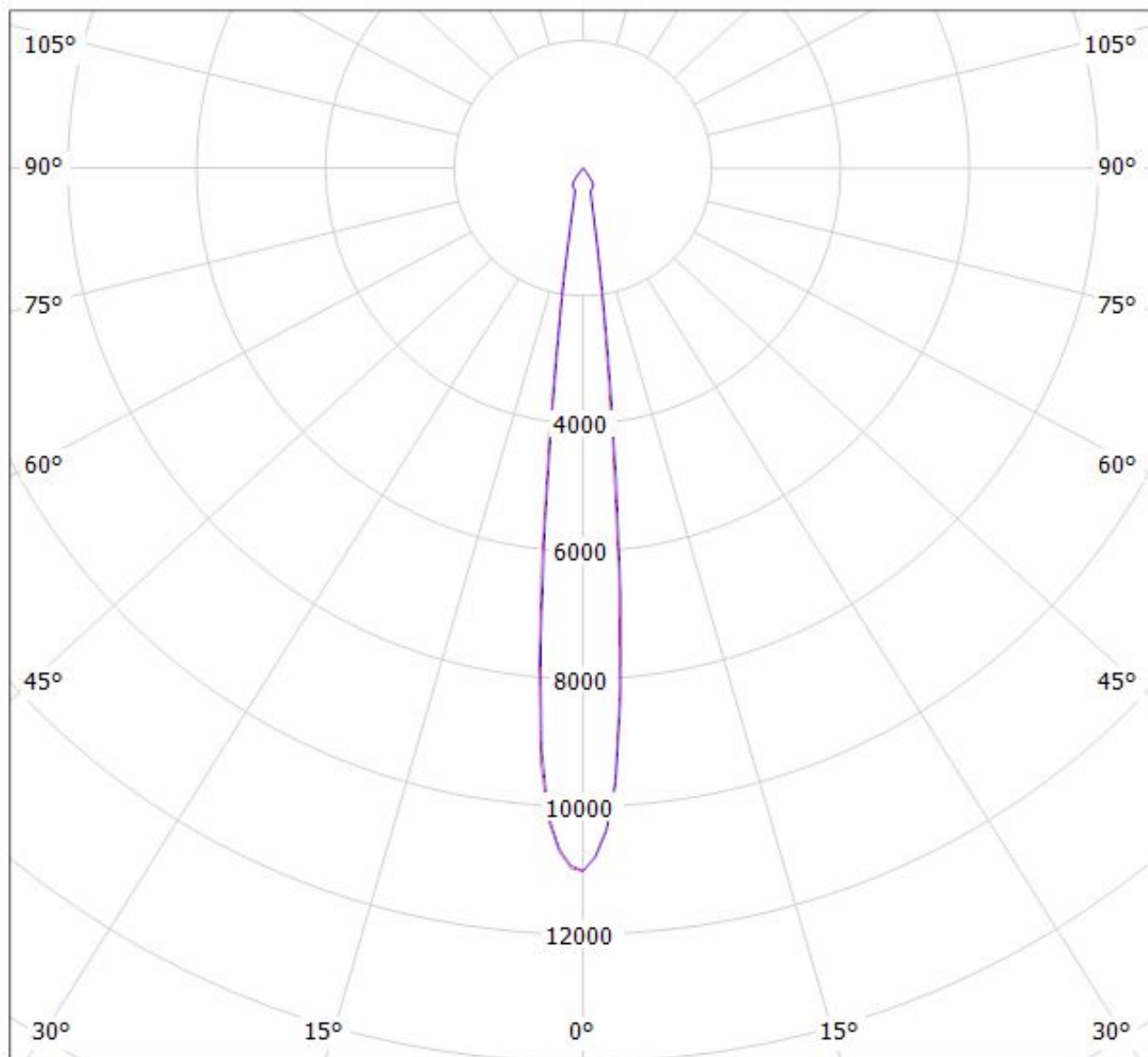

cd/klm

$\eta = 93\%$

— C0 - C180 — C90 - C270

Luminaire: Ledil Oy FCN13705_ANGELA-S+_B+W_434_TypL1_BRIDGELUX_V10_Gen7_SIMULATED
Lamps: 1 x BRIDGELUX V10 Gen7

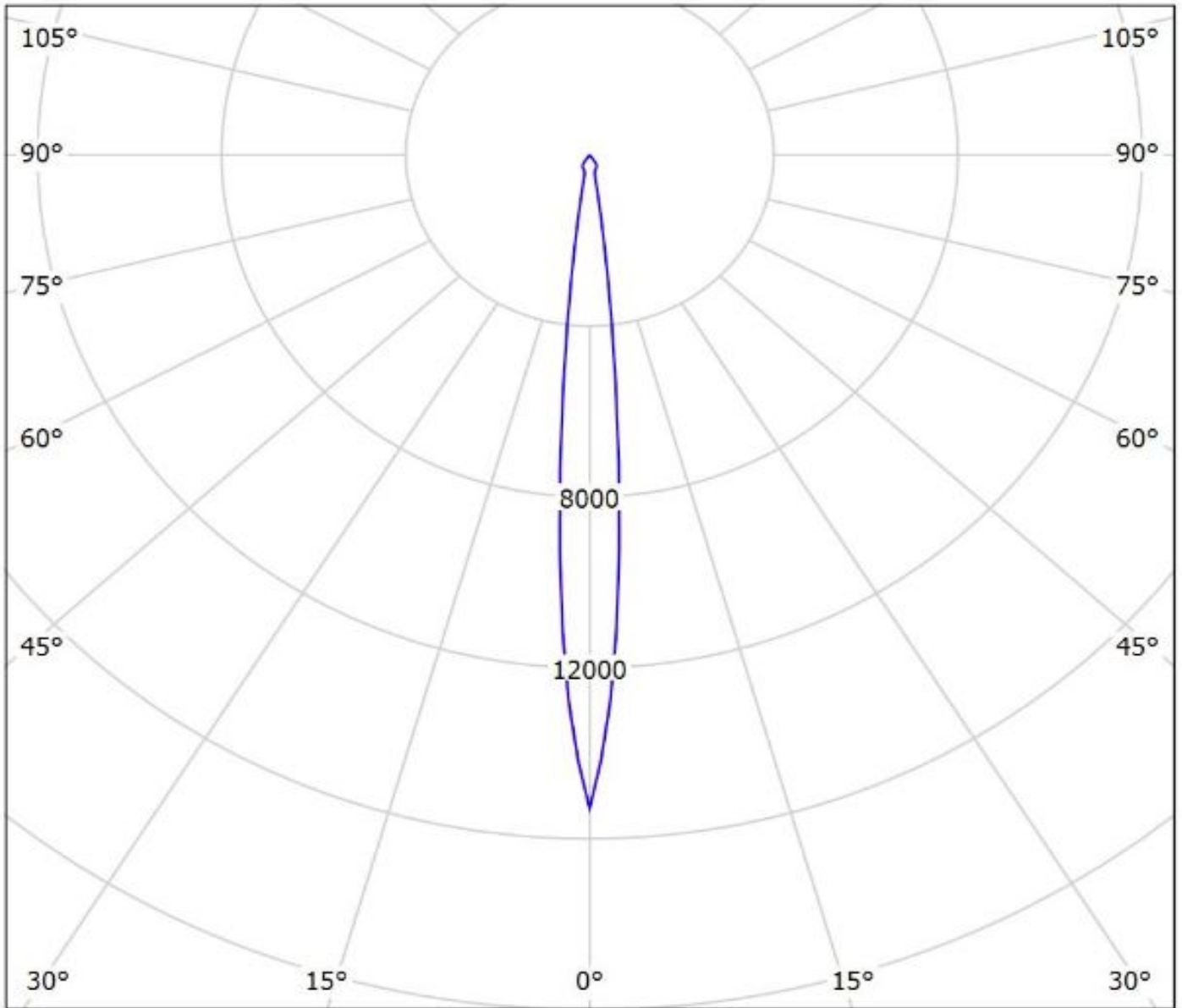

cd/klm

— C0 - C180 — C90 - C270

$\eta = 90\%$

Ledil FCN13705_ANGELA-S_(CLU720)_(433_Typ_L1) / LDC (Polar)

Luminaire: Ledil FCN13705_ANGELA-S_(CLU720)_(433_Typ_L1)

Lamps: 1 x Citizen_CLU720_(CLU720-1206B8-273M2G1)_1225.89lm@250mA_P=8.3W_I=0.25A

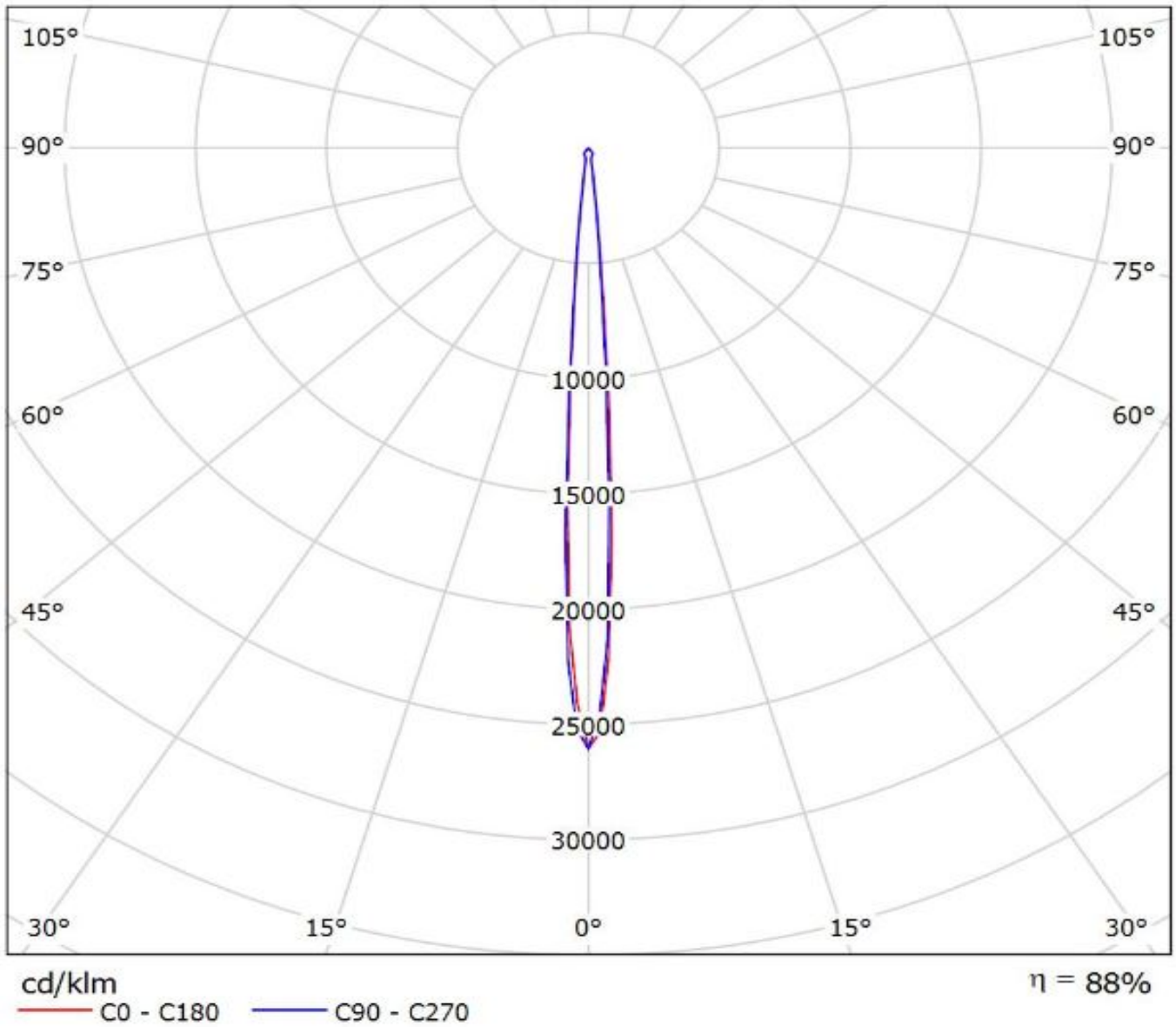

Luminaire: Ledil FCN13705_ANGELA-S_(CLU034)_ (433_Typ_L1)_ (C13658) Citizen_CLU034_(CLU034-1205B8-303M1A2)_1180.79lm@250mA_P=8.50075W_I=0.25A
Lamps: 1 x Citizen_CLU034_(433_Typ_L1)_ (C13658)_1173.16lm@250mA_P=8.475W_I=0.25A

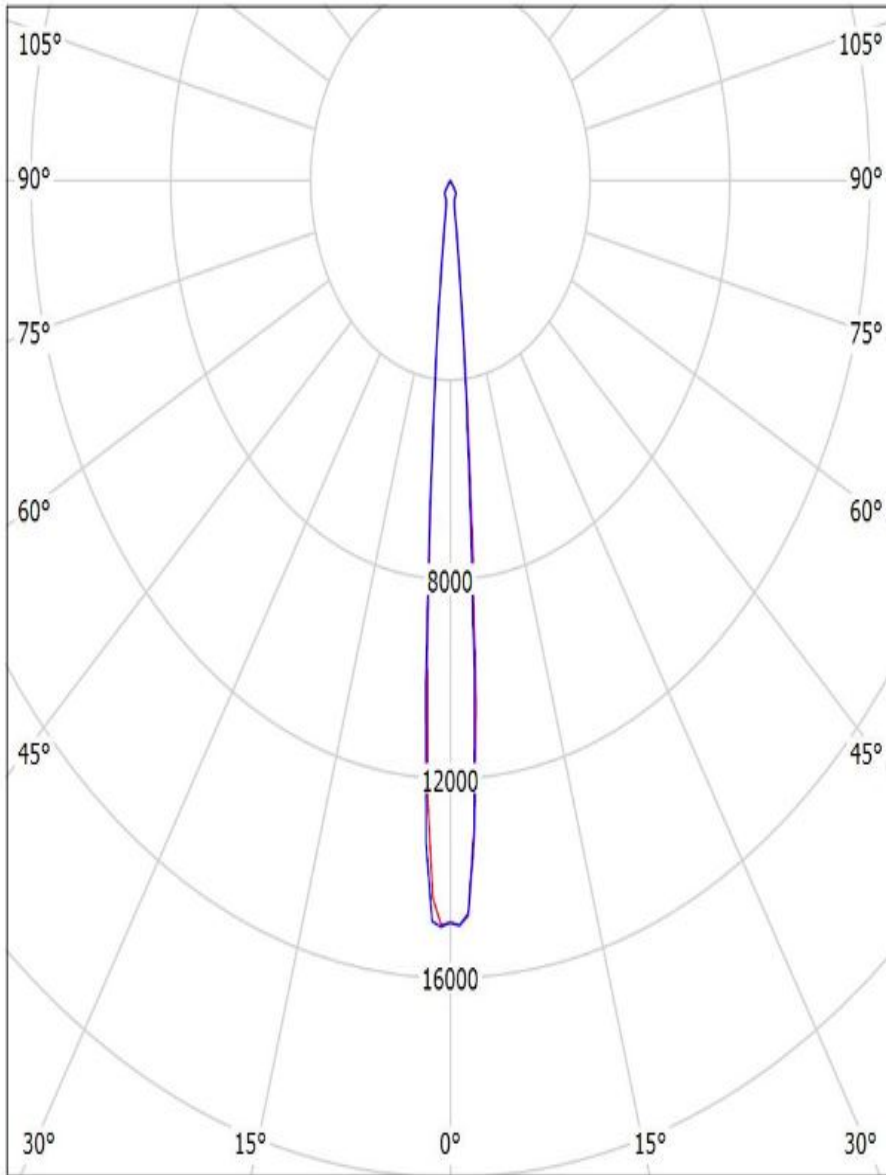

cd/klm

— C0 - C180 — C90 - C270

$\eta = 88\%$