



Chipsmall Limited consists of a professional team with an average of over 10 year of expertise in the distribution of electronic components. Based in Hongkong, we have already established firm and mutual-benefit business relationships with customers from,Europe,America and south Asia,supplying obsolete and hard-to-find components to meet their specific needs.

With the principle of "Quality Parts,Customers Priority,Honest Operation,and Considerate Service",our business mainly focus on the distribution of electronic components. Line cards we deal with include Microchip,ALPS,ROHM,Xilinx,Pulse,ON,Everlight and Freescale. Main products comprise IC,Modules,Potentiometer,IC Socket,Relay,Connector.Our parts cover such applications as commercial,industrial, and automotives areas.

We are looking forward to setting up business relationship with you and hope to provide you with the best service and solution. Let us make a better world for our industry!



Contact us

Tel: +86-755-8981 8866 Fax: +86-755-8427 6832

Email & Skype: info@chipsmall.com Web: www.chipsmall.com

Address: A1208, Overseas Decoration Building, #122 Zhenhua RD., Futian, Shenzhen, China



DETAILS

Product Number	FCN13707_ANGELA-W
Family	ANGELA
Type	RefPack
Color	metal
Diameter	119,5 mm
Height	79,31 mm
Style	round
Optic Material	
Holder Material	
Fastening	
Status	production ready
ROHS Compliant	Yes
Date Updated	3/11/2016



OPTICAL PROPERTIES

LED	Viewing Angle	Light Beam	Efficiency	cd/lm	Connector
VERO18	38 deg	Wide	84 %	1.500	LEDiL: LEDiL
VERO13	33 deg	Wide	86 %	1.700	LEDiL: LEDiL
V15 Gen6	35 deg	Wide	84 %	1.700	Bender Wirth: 456 Typ L2
V10 Gen7	sim: 34	Wide	sim: 89 %	sim: 2.300	Bender Wirth: 434 Typ L1
CLU720/721	34 deg	Wide	82 %	1.600	Bender Wirth: 433 Typ L1
CLL03x/CLU03x	36 deg	Wide	82 %	1.500	Bender Wirth: 433 Typ L1
CLU700/701	30 deg	Wide	82 %	1.800	Bender Wirth: 434 Typ L1
CLL02x/CLU02x (LES10)	33 deg	Wide	83 %	1.700	Bender Wirth: 434 Typ L1
CXA/B 1816 & CXA/B 1820 & CXA 1850	34 deg	Wide	82 %	1.600	Bender Wirth: 437 Typ L1
CXA/B 15xx	31 deg	Wide	83 %	1.800	Bender Wirth: 441 Typ L1
LUXEON CoB 1202/1203	31 deg	Wide	83 %	1.700	Bender Wirth: 438 Typ L1
CXM-14	sim: 36	Wide	sim: 82 %	sim: 1.500	Bender Wirth: 433 Typ L1
CXM-9	sim: 33	Wide	sim: 83 %	sim: 1.700	Bender Wirth: 434 Typ L1
COB L-Type (LES 9)	31 deg	Wide	84 %	1.800	Bender Wirth: 438 Typ L1
COB J-Type	36 deg	Wide	82 %	1.500	Bender Wirth: 463 Typ L2
COB L-Type (LES 11)	34 deg	Wide	82 %	1.600	Bender Wirth: 438 Typ L1
Soleriq P9	32 deg	Wide	86 %	1.700	Bender Wirth: 461 Typ L1
Soleriq P13	34 deg	Wide	86 %	1.600	Bender Wirth: 437 Typ L1
Soleriq S13	35 deg	Wide	82 %	1.600	Bender Wirth: 437 Typ L1
LC026B/LC040B	39 deg	Wide	82 %	1.400	Bender Wirth: 450 Typ L2
ZC12/18	sim: 36	Wide	sim: 82 %	sim: 1.500	Bender Wirth: 433 Typ L1
ZC4/6	sim: 33	Wide	sim: 83 %	sim: 1.700	Bender Wirth: 434 Typ L1
SLE G5 LES11	32 deg	Wide	83 %	1.700	Bender Wirth: 434 Typ L1

Relative intensity of FCN13707_ANGELA-W_(V15)

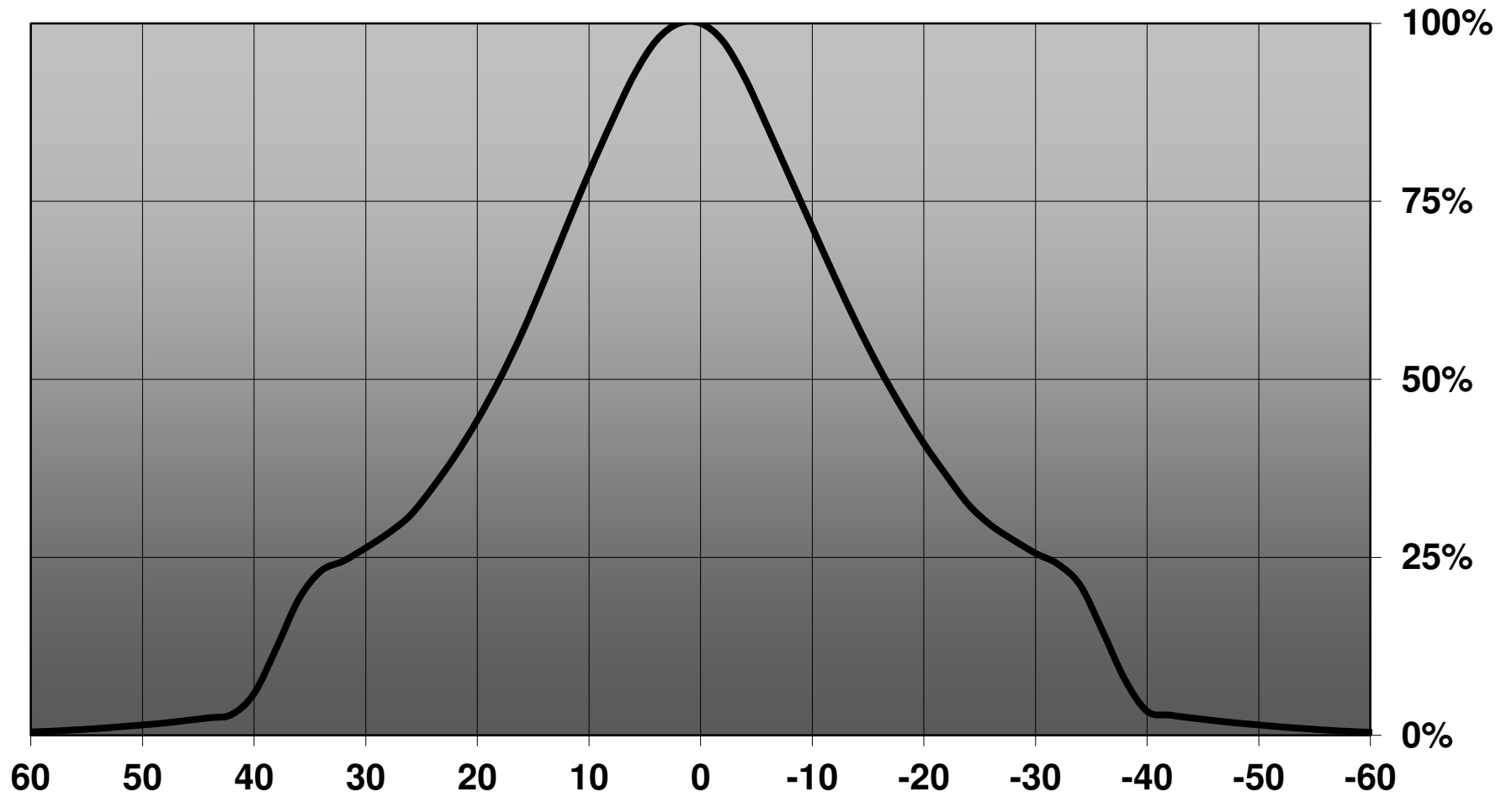

H G F E D C B A

4
3
2
1

4
3
2
1

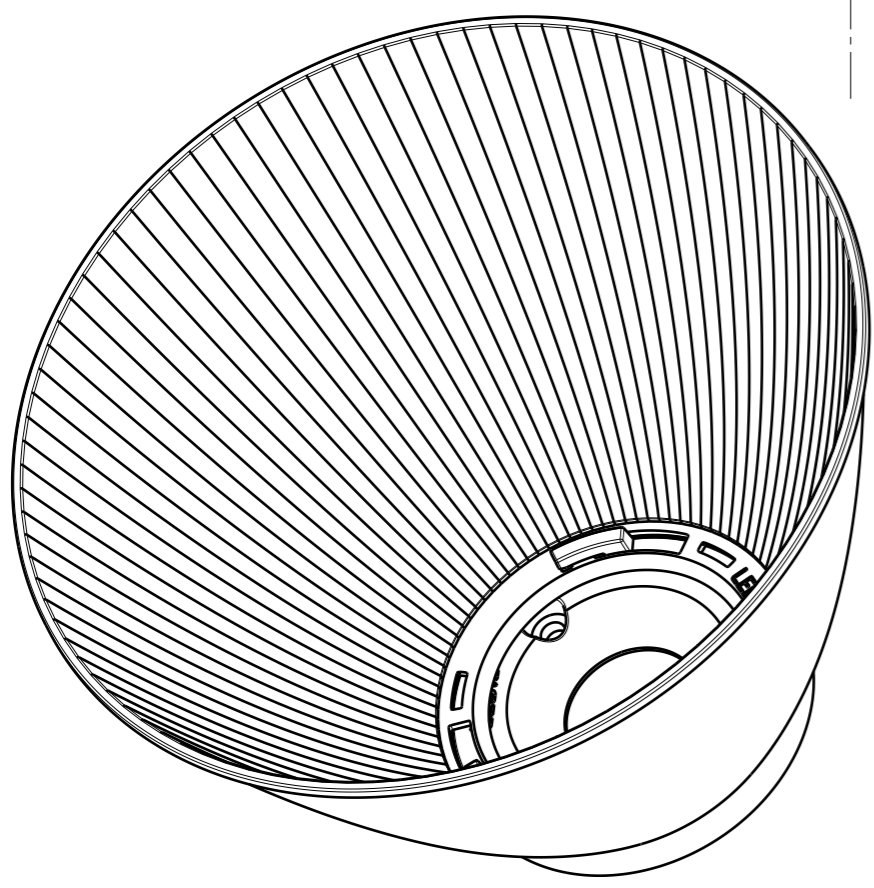
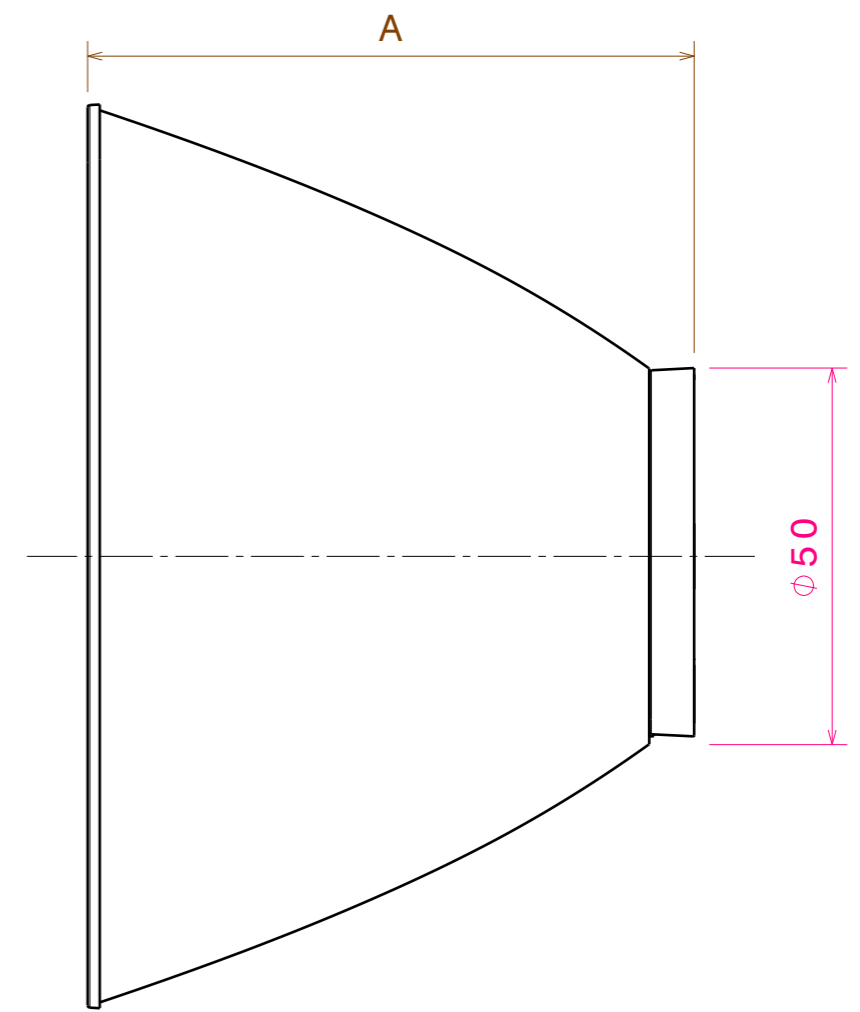
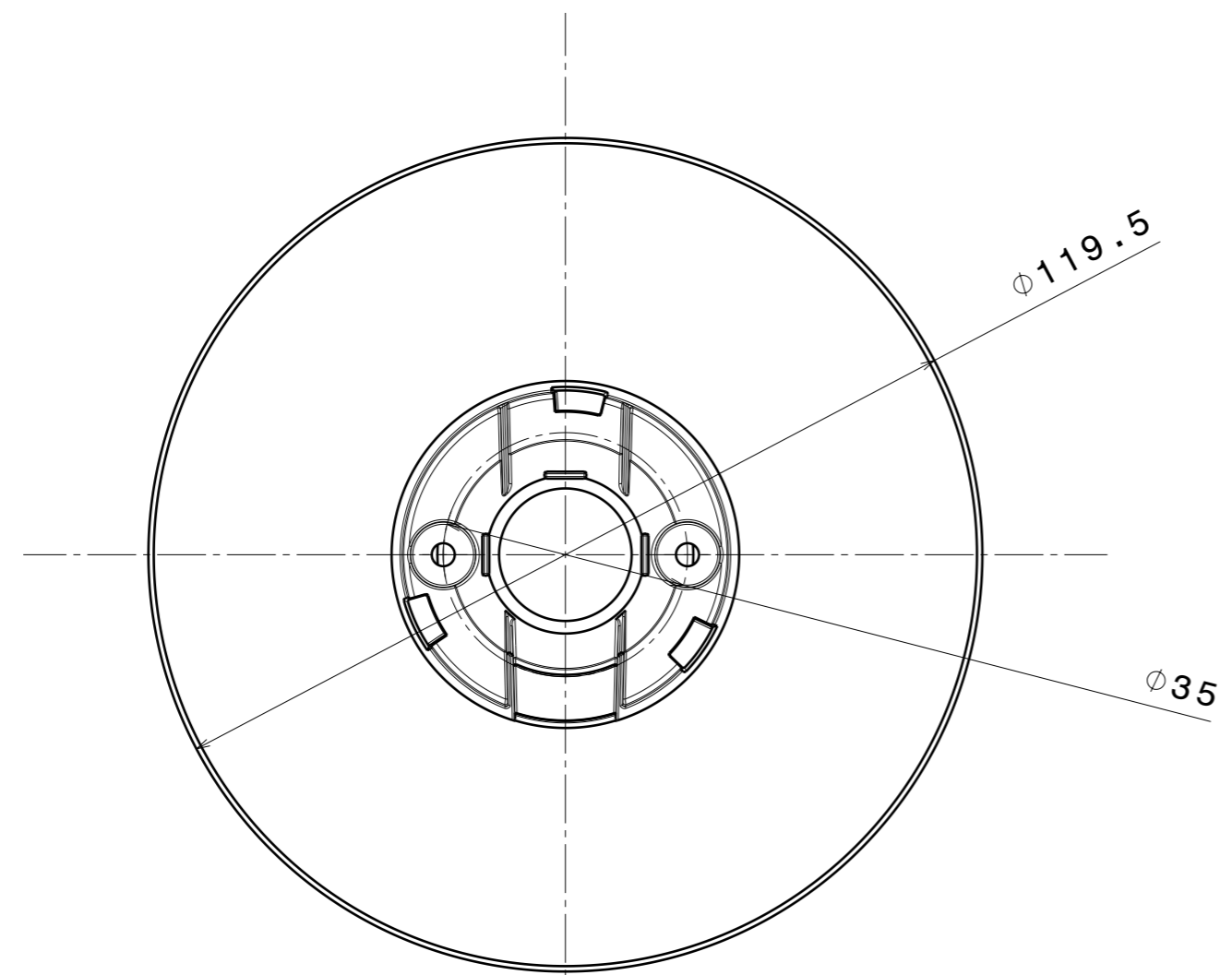

	DIMENSION A
WITH LEDIL LUXEON S SOCKETS	80.5 mm
WITH TYCO SOCKET	80.5 mm
WITH LEDIL BRIDGELUX VERO SOCKETS 13-18	79.5 mm

Tolerances if not otherwise shown
 According to DIN ISO 2768-1
 Linear measures:
 Up to 30mm class M, otherwise class C.
 According to DIN ISO 2768-2
 Form and position: class L

LEDiL Ledil Oy
 Salorankatu 10
 FIN 24240 SALO
 Finland

THIRD ANGLE PROJECTION:

DRAWING TITLE
DATA SHEET ANGELA

This drawing is the property of LEDiL Oy. It may not be reproduced, copied or communicated without a written agreement with LEDiL Oy."

SIZE	PART NUMBER
A3	-

SCALE	1:1	WEIGHT	-	SHEET	1/1
-------	-----	--------	---	-------	-----

H G B A

Luminaire: LEDiL Oy FCN13707_ANGELA-W_(Vero18) Eff.83.9%
Lamps: 1 x VERO18_(BXRC30E4000F)_882.261lm@250mA P=6.73161W I=249.8mA

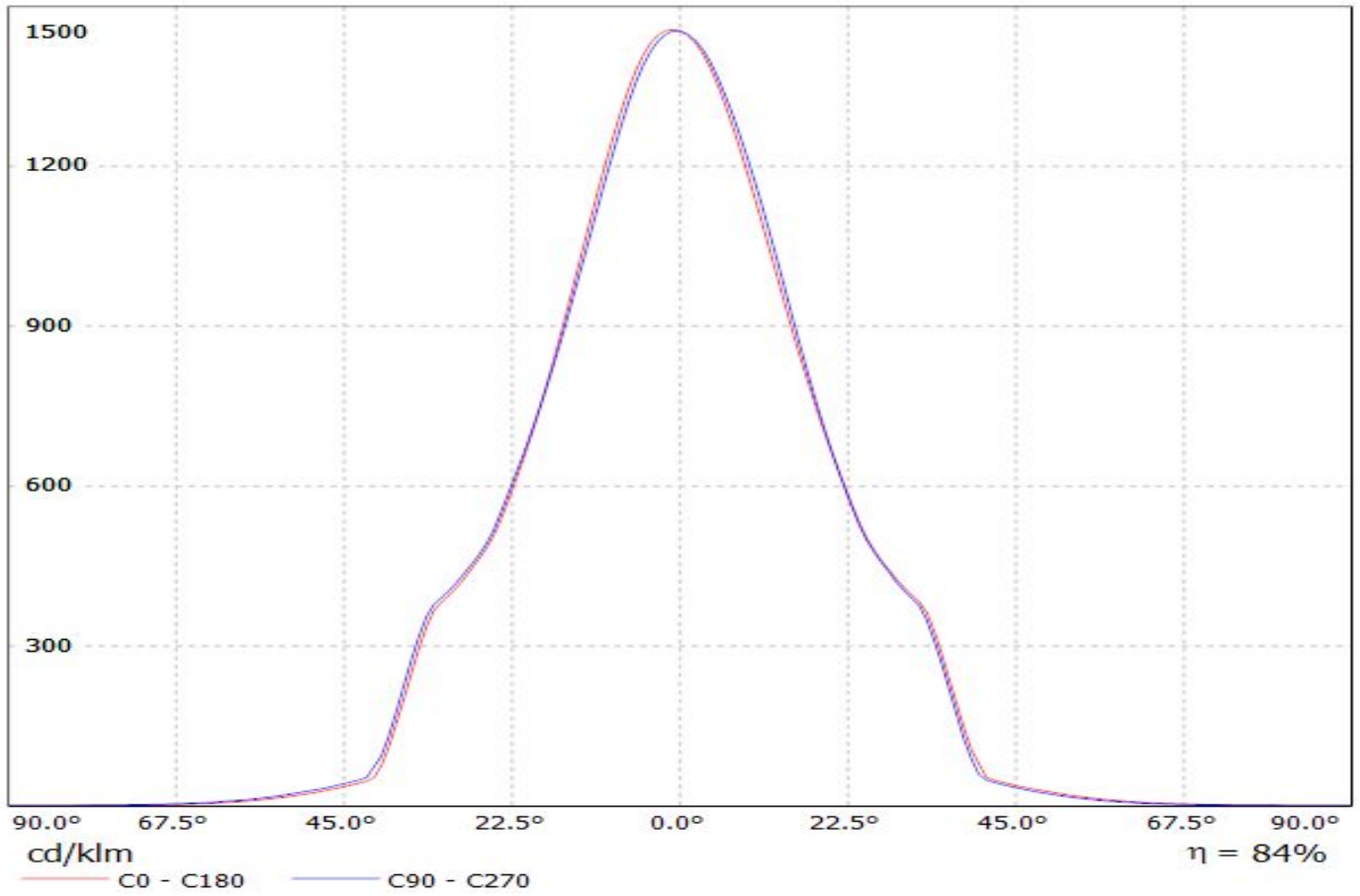

Luminaire: LEDiL Oy FCN13707_ANGELA-W_(VERO13) Eff.86.2%
Lamps: 1 x Bridgelux_VERO13_(BXRC-30E2000C)_1065.05lm@250mA_P=7.63813W_I=249.8mA

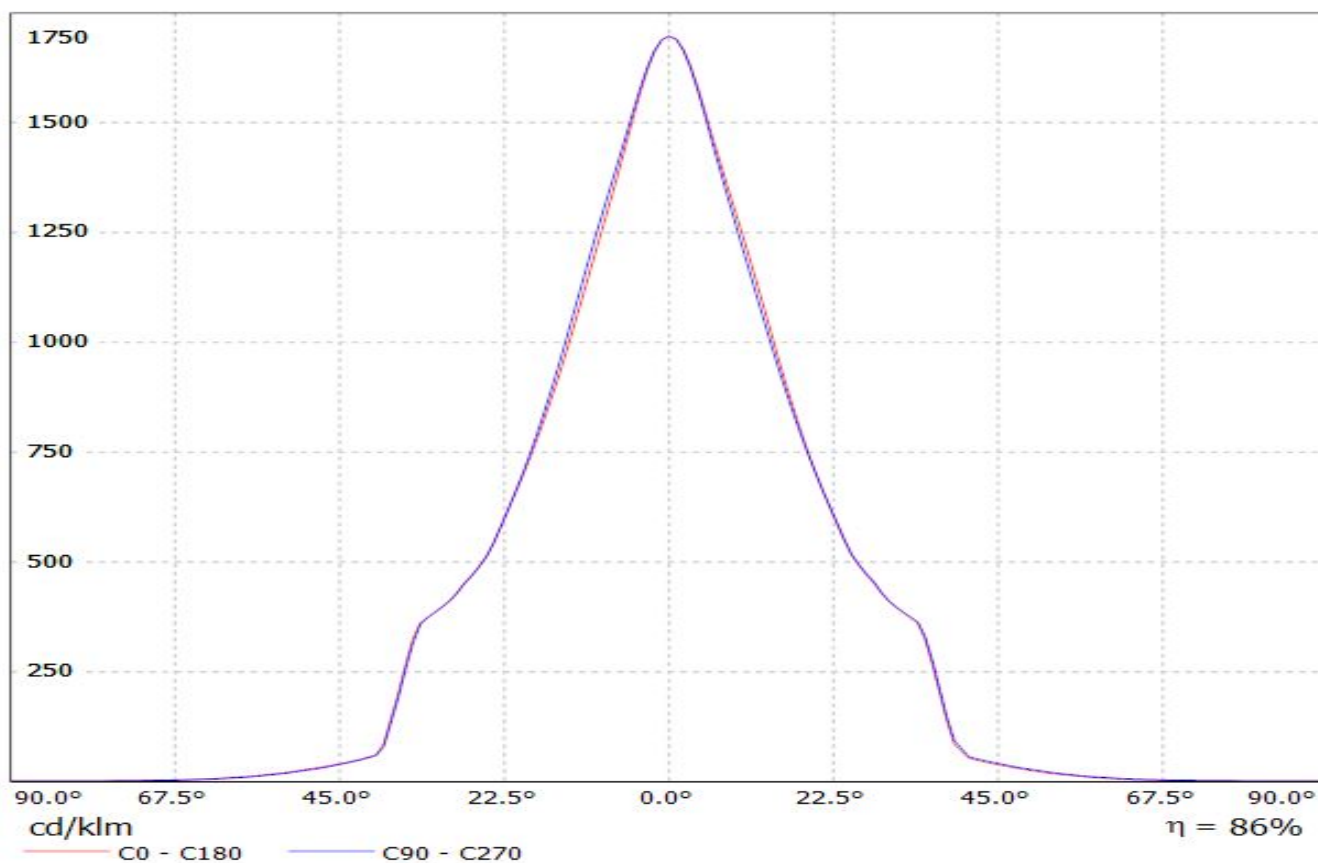

Luminaire: Ledil Oy FCN13707_ANGELA-W+_B+W_434_TypL1_BRIDGELUX_V10_Gen7_SIMULATED
Lamps: 1 x BRIDGELUX V10 Gen7

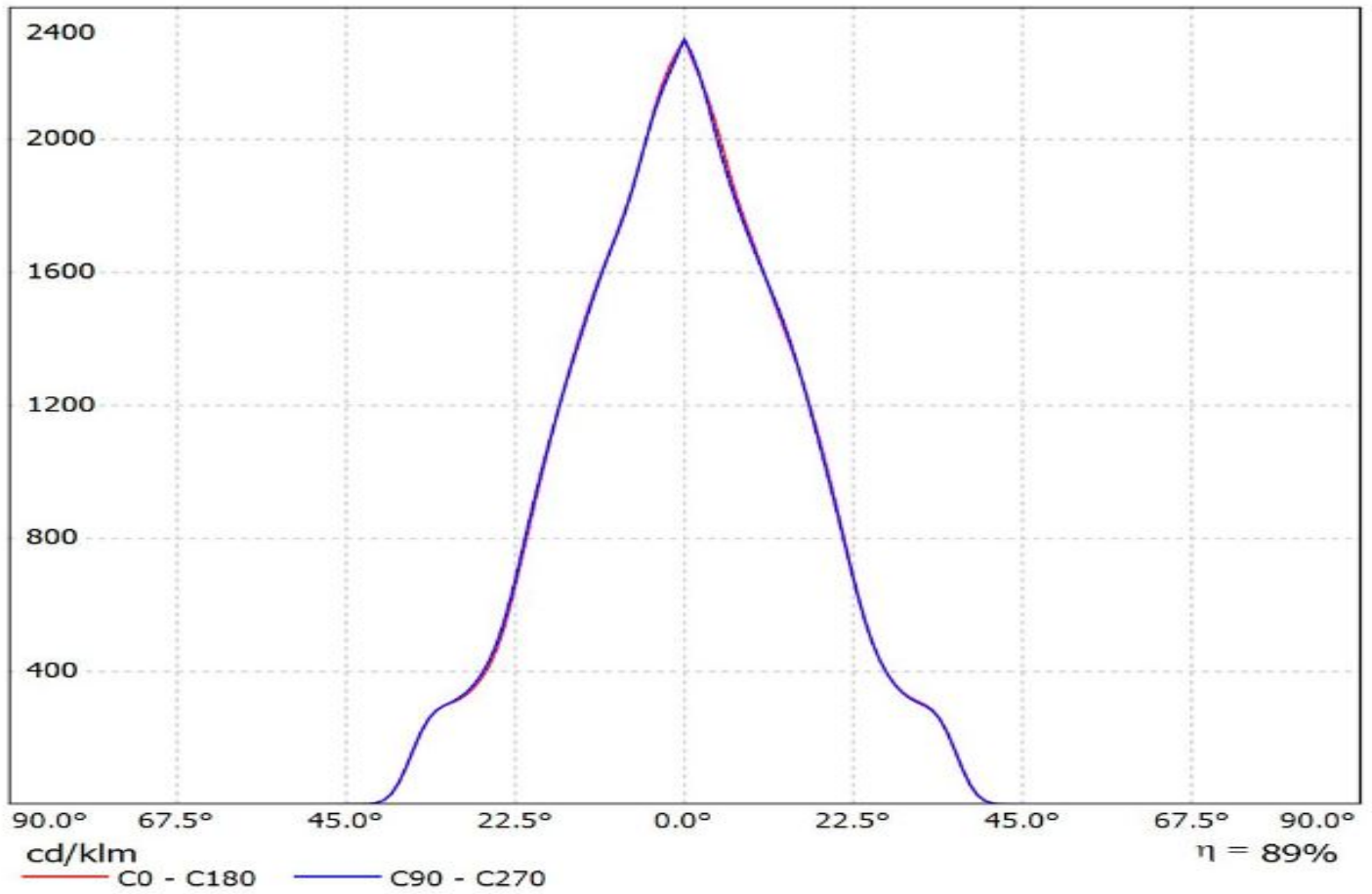

Ledil FCN13707_ANGELA-W_(CLU720)_(433_Typ_L1) / LDC (Linear)

Luminaire: Ledil FCN13707_ANGELA-W_(CLU720)_(433_Typ_L1)

Lamps: 1 x Citizen_CLU720_(CLU720-1206B8-273M2G1)_1225.89lm@250mA_P=8.3W_I=0.25A

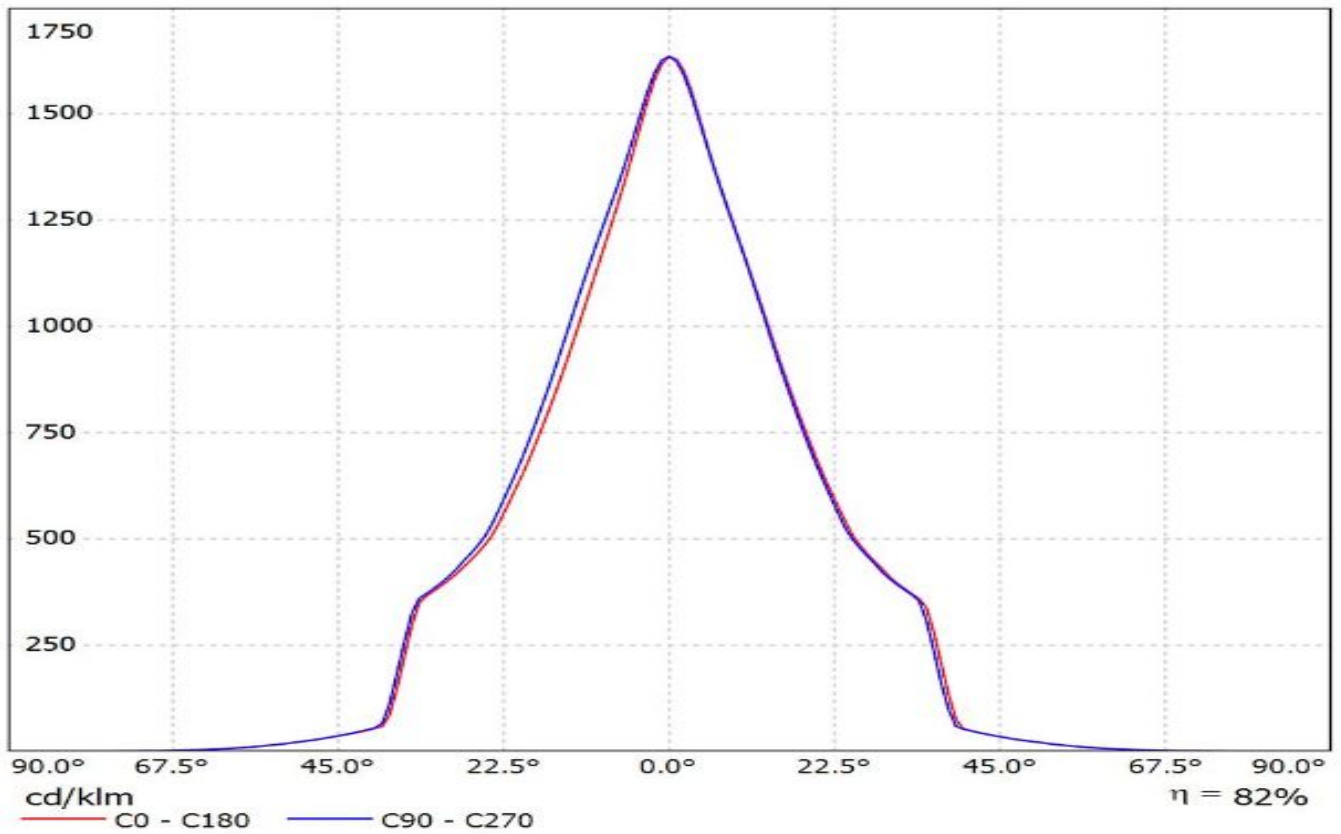

Luminaire: Ledil FCN13707_ANGELA-W_(CLU034)_ (433_Typ_L1)_ (C13658) Citizen_CLU034_(CLU034-1205B8-303M1A2)_1180.79lm@250mA_P=8.50075W_I=0.25A
Lamps: 1 x Citizen_CLU034_(433_Typ_L1)_ (C13658)_1173.16lm@250mA_P=8.475W_I=0.25A

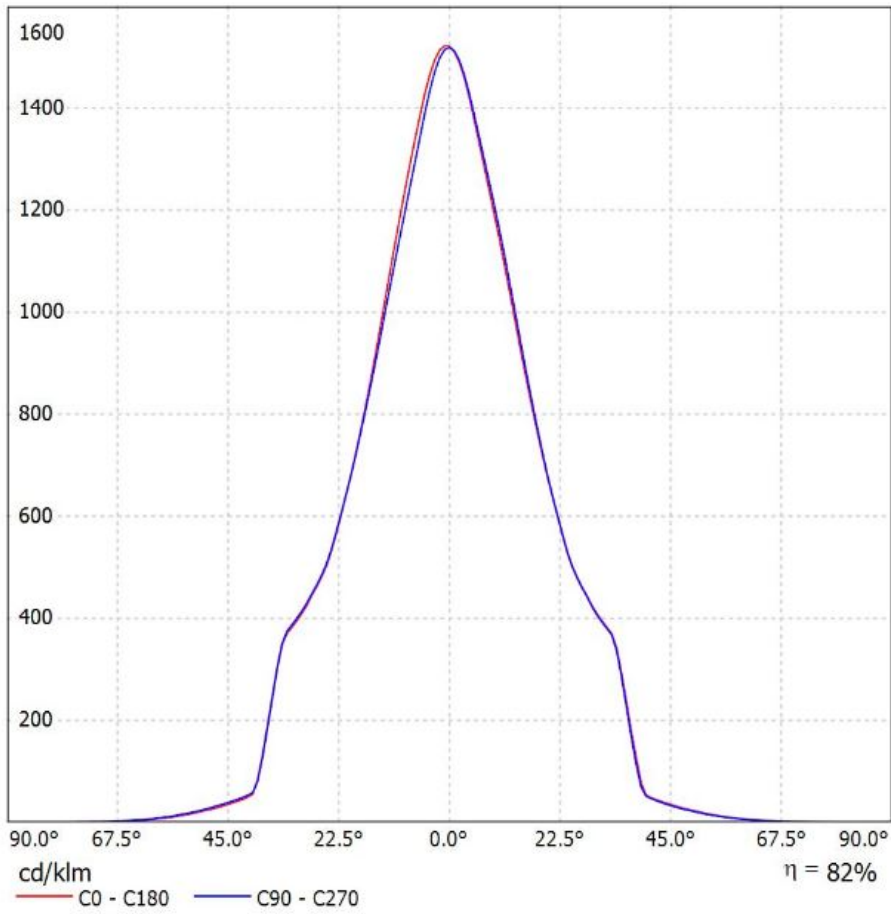

Luminaire: Ledil FCN13707_ANGELA-W_(CLU700)_ (434_Typ_L1) Citizen_CLU700_(CLU700-1002B8-273M2G1)_390.128lm@100mA_P=3W_I=0.10A
Lamps: 1 x Citizen_CLU700_(CLU700-1002B8-273M2G1)_388.036lm@100mA_P=3W_I=0.10A

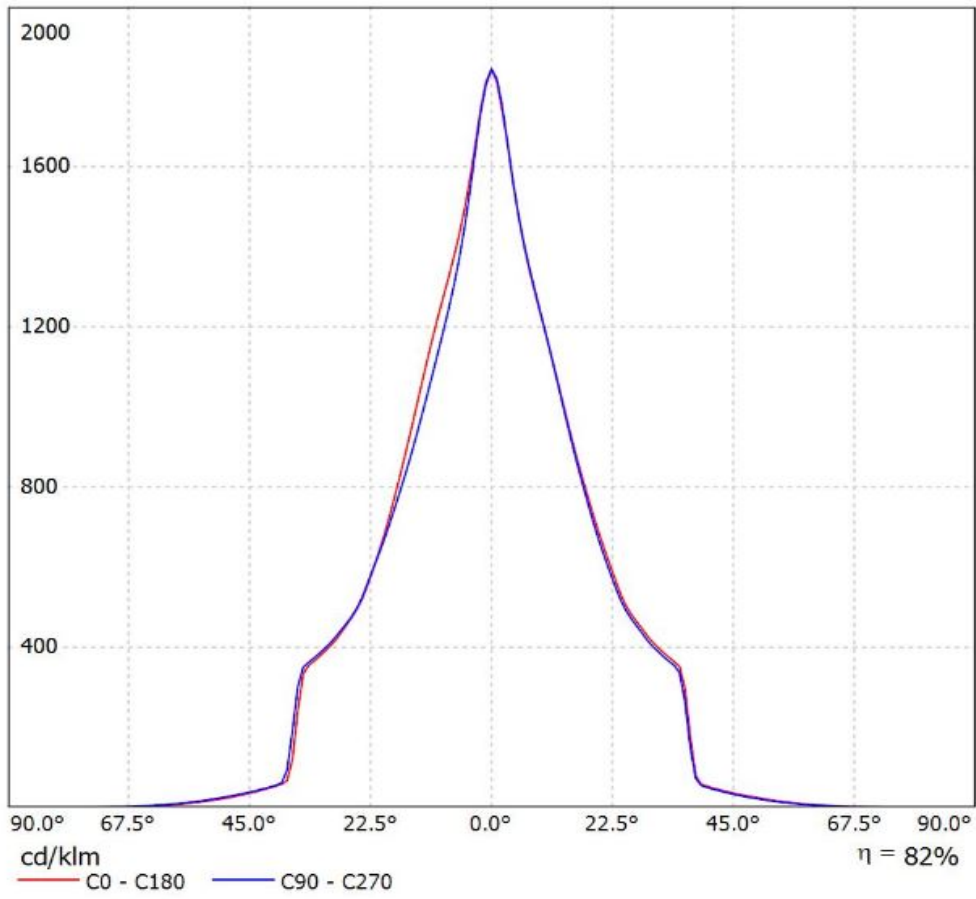

Luminaire: Ledil FCN13707_ANGELA-W_(CLU024)_ (433_Typ_L1) Citizen_CLU024_(433_Typ_L1)_
(C13658_CLAMP-VERO13-18)_1071.07lm@250mA_P=8.43W_I=0.25A
Lamps: 1 x Citizen_CLU024_(433_Typ_L1)_ (C13658_CLAMP-VERO13-18)
_1071.07lm@250mA_P=8.43W_I=0.25A

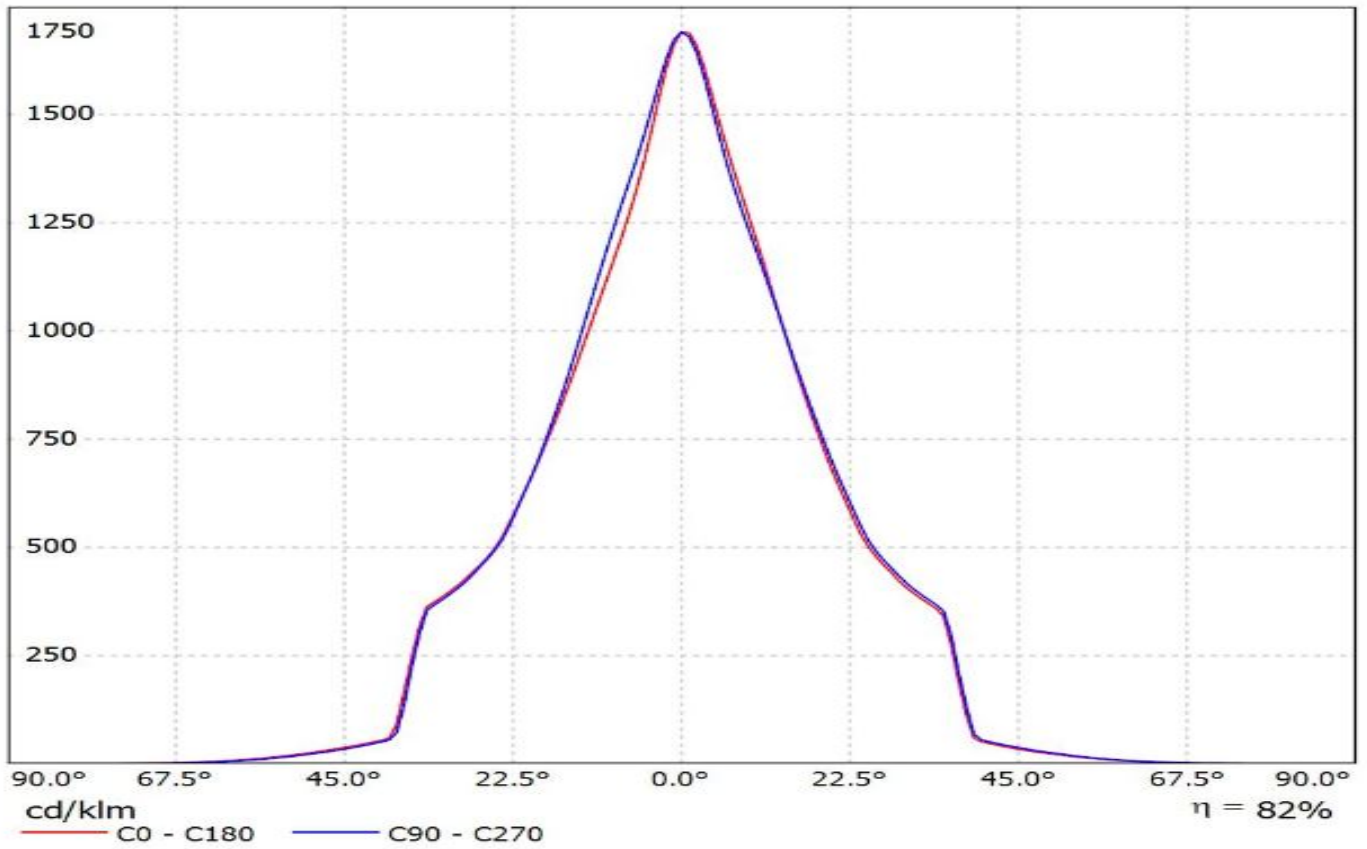

Luminaire: Ledil FCN13707_ANGELA-W_(CXA1850)

Lamps: 1 x CREE_CXA1850_(CXA1850-30F-T4-N0Y-00001)_831.914lm@250mA_CCT=3000K_P=8.27W_I=0.25A

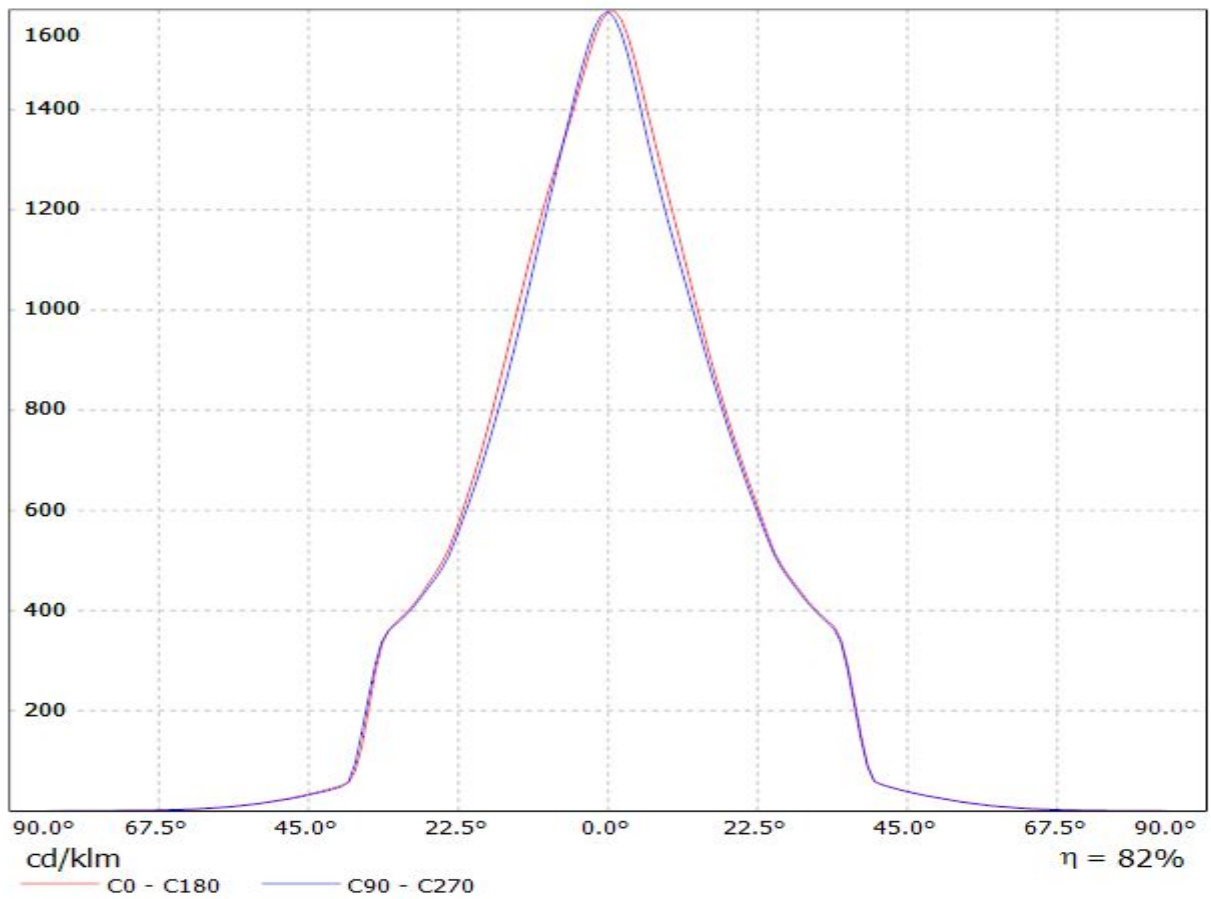

Luminaire: LEDiL Oy FCN13707_ANGELA-W_(CXA1520)_ (441_Typ_L1)

Lamps: 1 x Cree_CXA1520_(CXA1520-30F-N4-00H-00001)_993.209lm@250mA_P=8.74575W_I=0.2499A

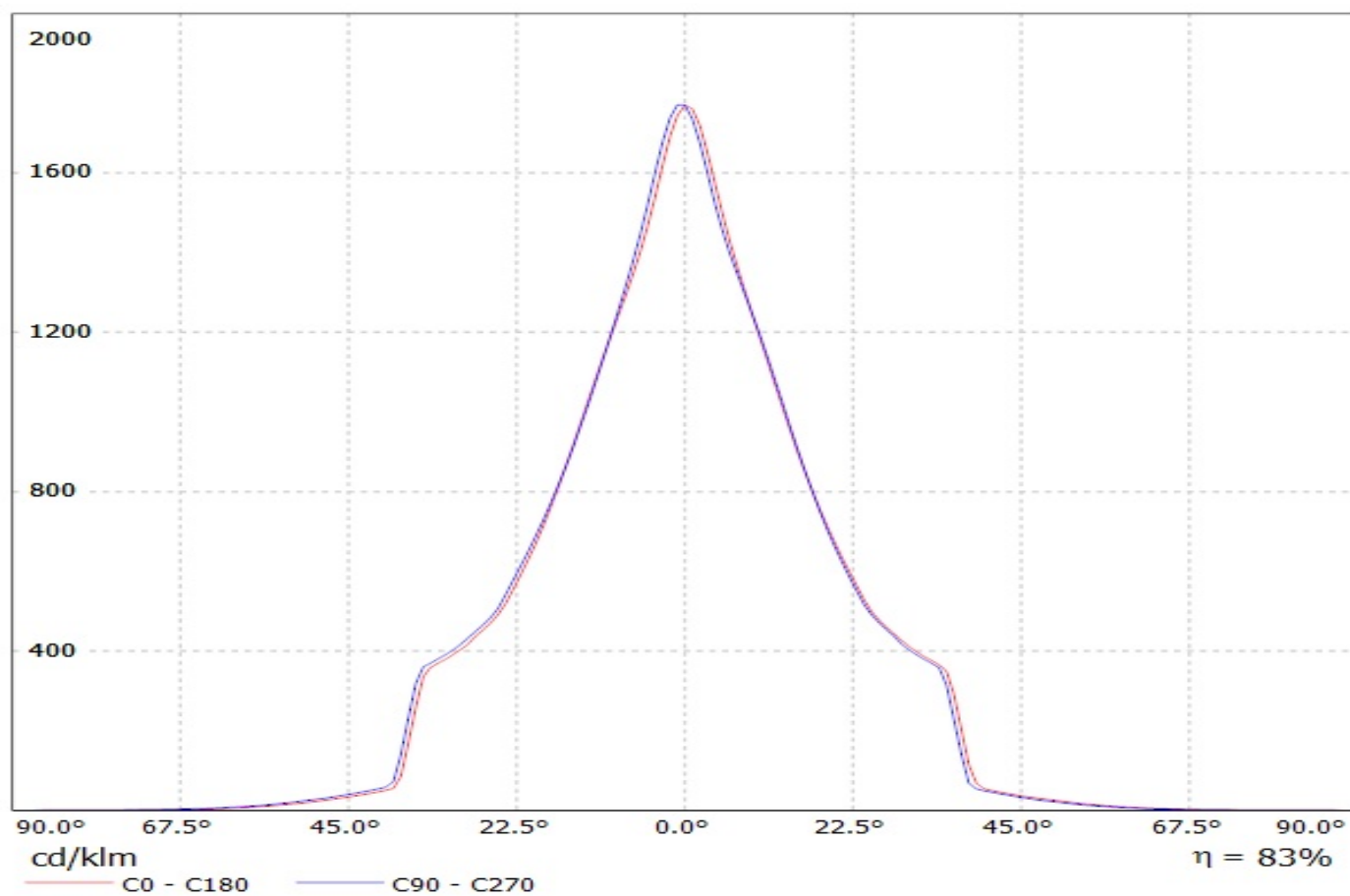

Luminaire: LEDiL Oy FCN13707_ANGELA-W_(LUXEON_CoB_1203)_ (438_Typ_L1)_ (C13658_CLAMP-VERO13-18)
Lamps: 1 x LUXEON_CoB_1203_(438_Typ_L1)_ (C13658_CLAMP-VERO13-18)_984.561lm@250mA_P=8.6828W_η=0.25A

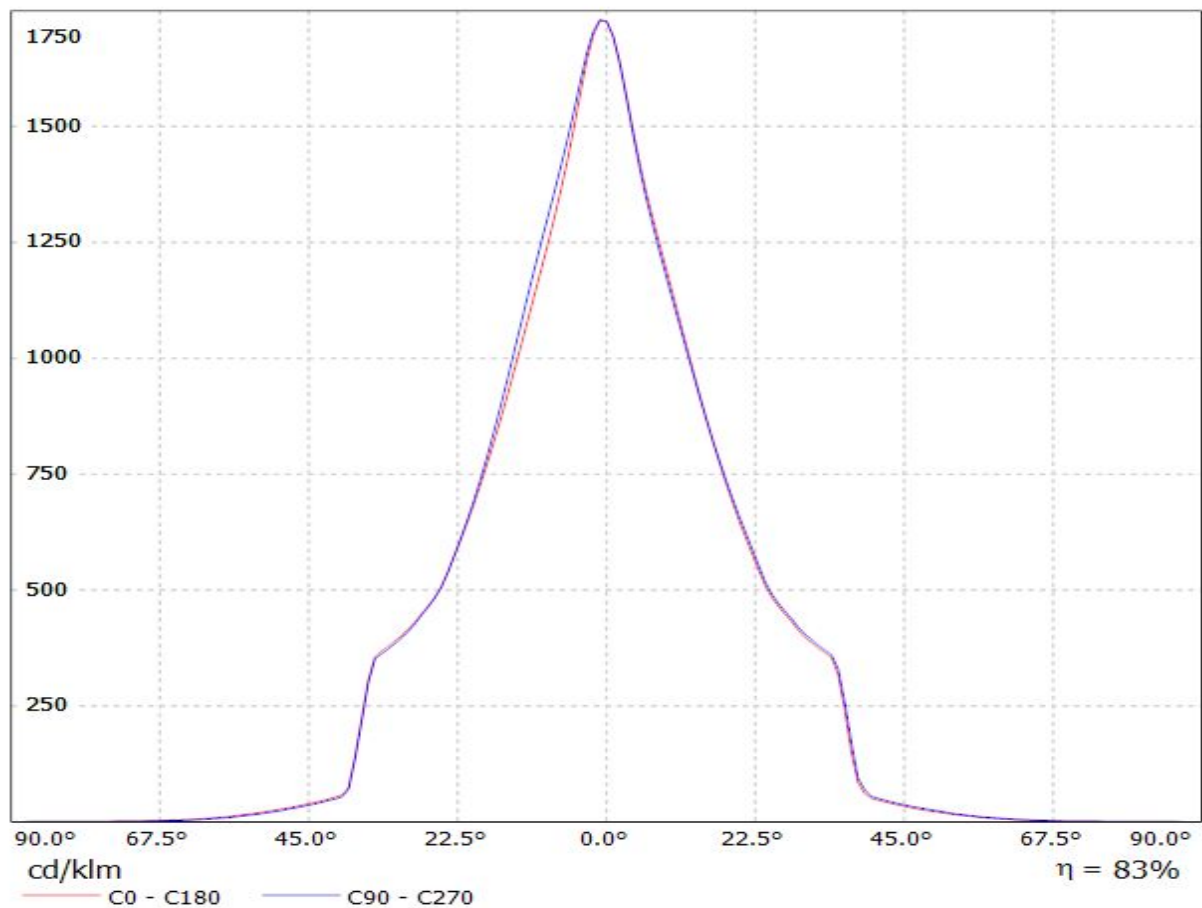

Luminaire: LEDiL Oy FCN13707_ANGELA-W_(NFCLL036B)

Lamps: 1 x Nichia NFCLL036B (sm403J1300R8000)_541.131lm@100mA_CCT=4000K_P=3.34324W_I=0.100A

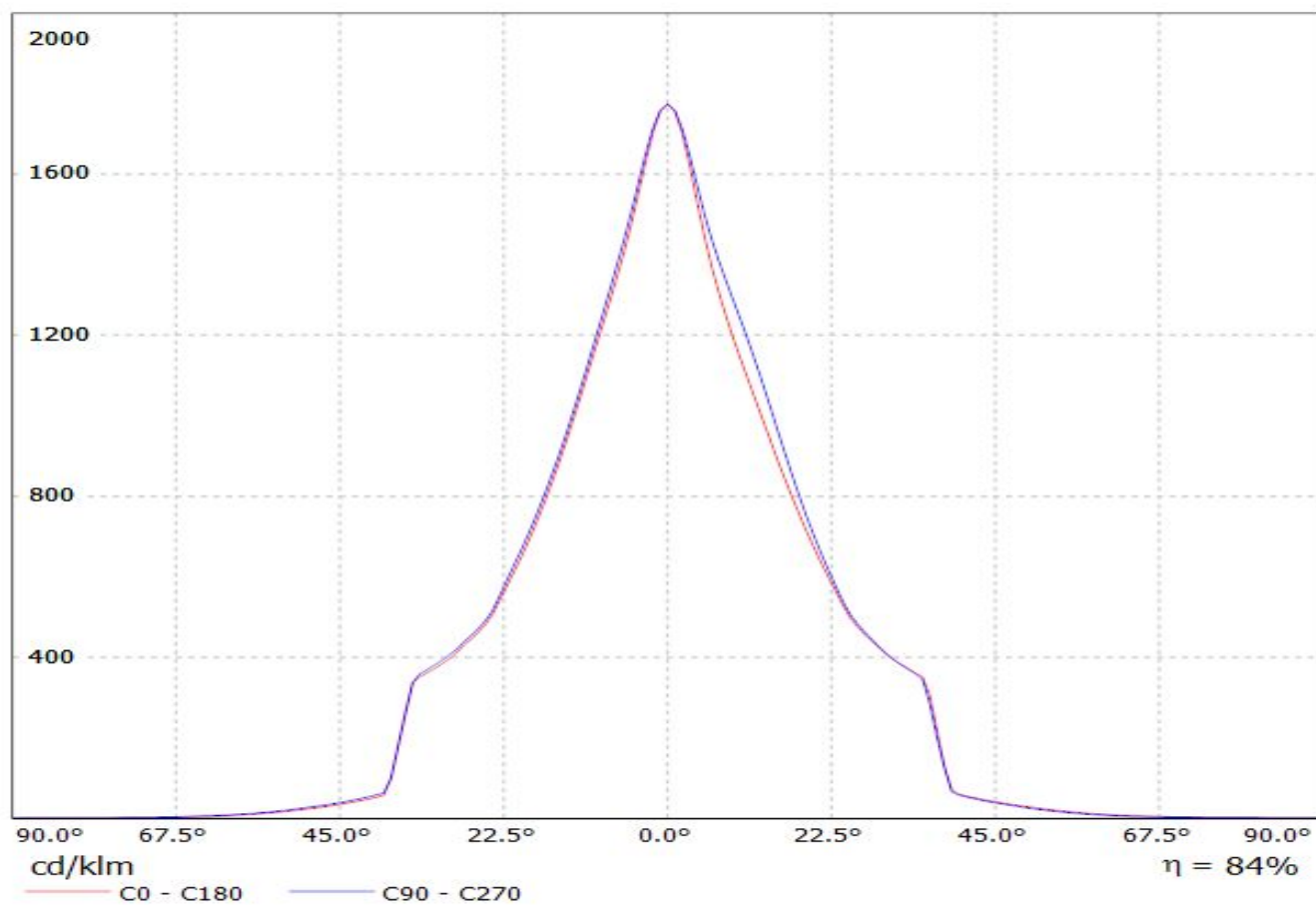

Luminaire: Ledil FCN13707_ANGELA-W_(NFDxJ130B)
Lamps: 1 x Nichia_NFDxJ130B_(463 Typ L2)_C13658_CLAMP-
VERO13_1504.8lm@250mA_P=8.27W_I=0.25A

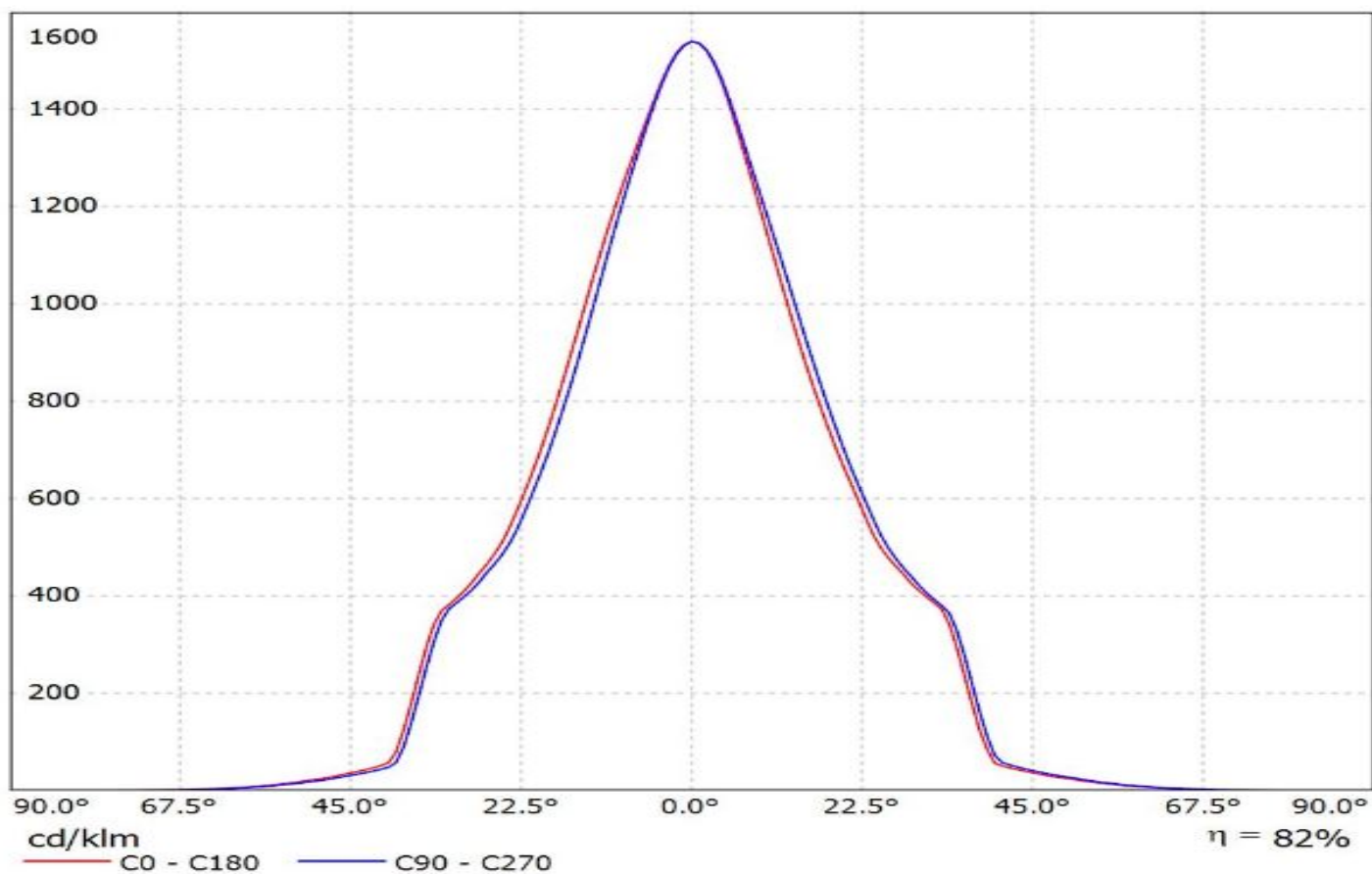

Luminaire: Ledil FCN13707_ANGELA-W_(NFCLL060B)

Lamps: 1 x Nichia_NFCLL060B_(438_TYP_L1)_C13658_1356.65lm@250mA_P=8.375W_I=0.25A

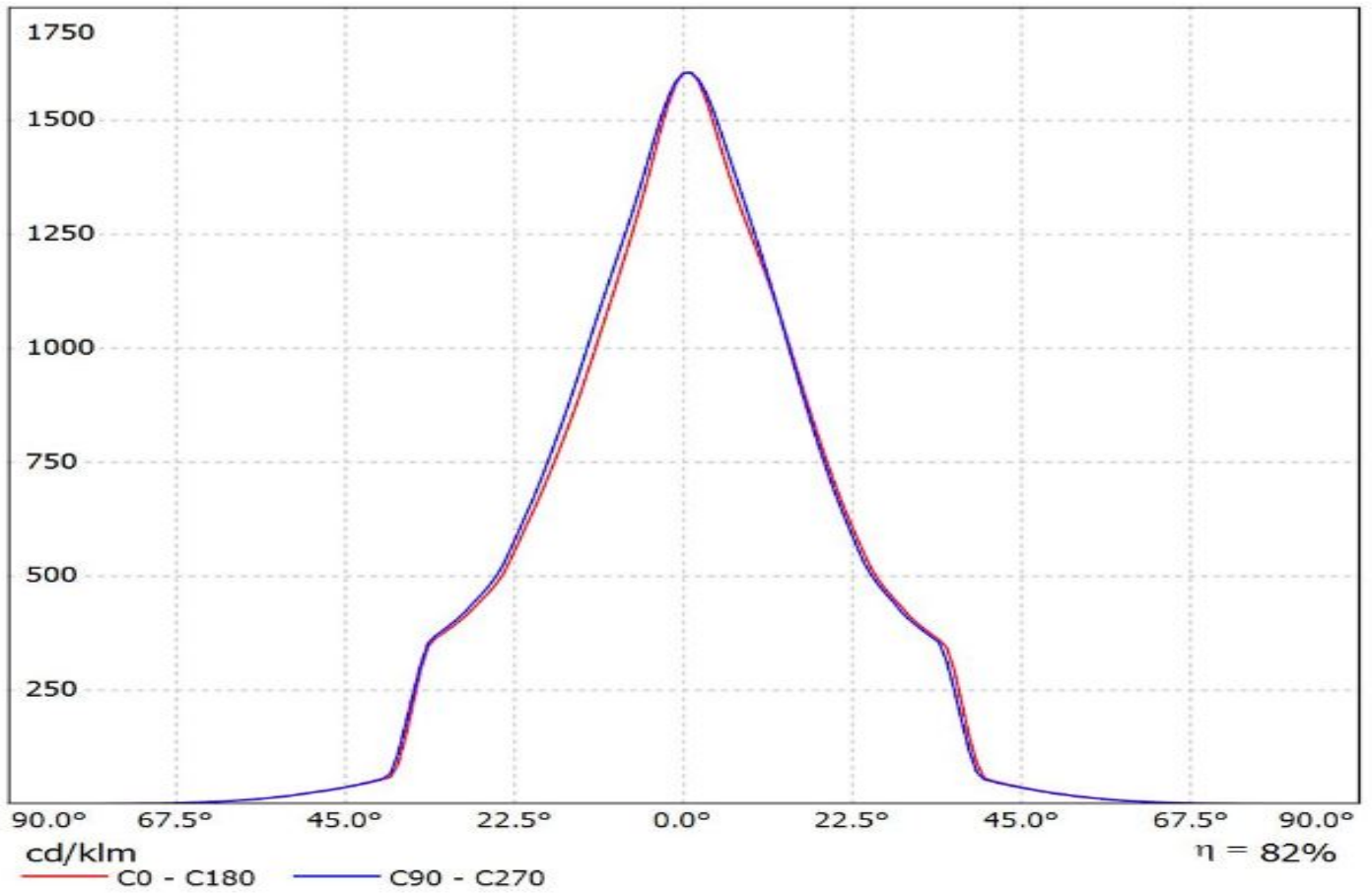

Luminaire: Ledil FCN13707_ANGELA-W_(Soleriq_P9)

Lamps: 1 x Osram_Soleriq_P9_(GW_MAFJB1.EM)_972.417lm@250mA_CCT=4299K_P=6.9W_I=0.25A

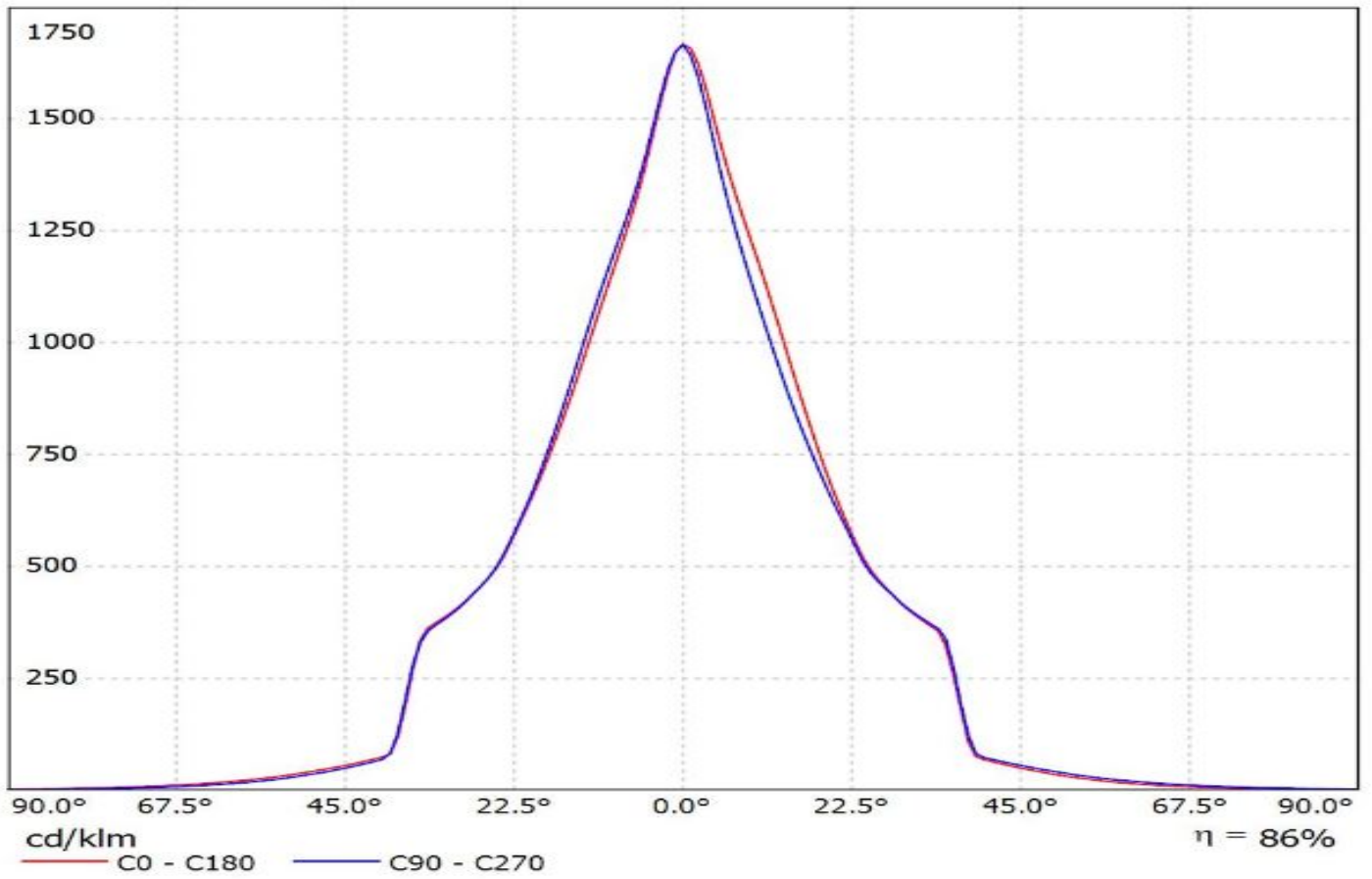

Luminaire: Ledil FCN13707_ANGELA-W_(Soleriq_P13)

Lamps: 1 x Osman_Soleriq_P13_1009.11lm@250mA_P=6.9385W_I=0.25A

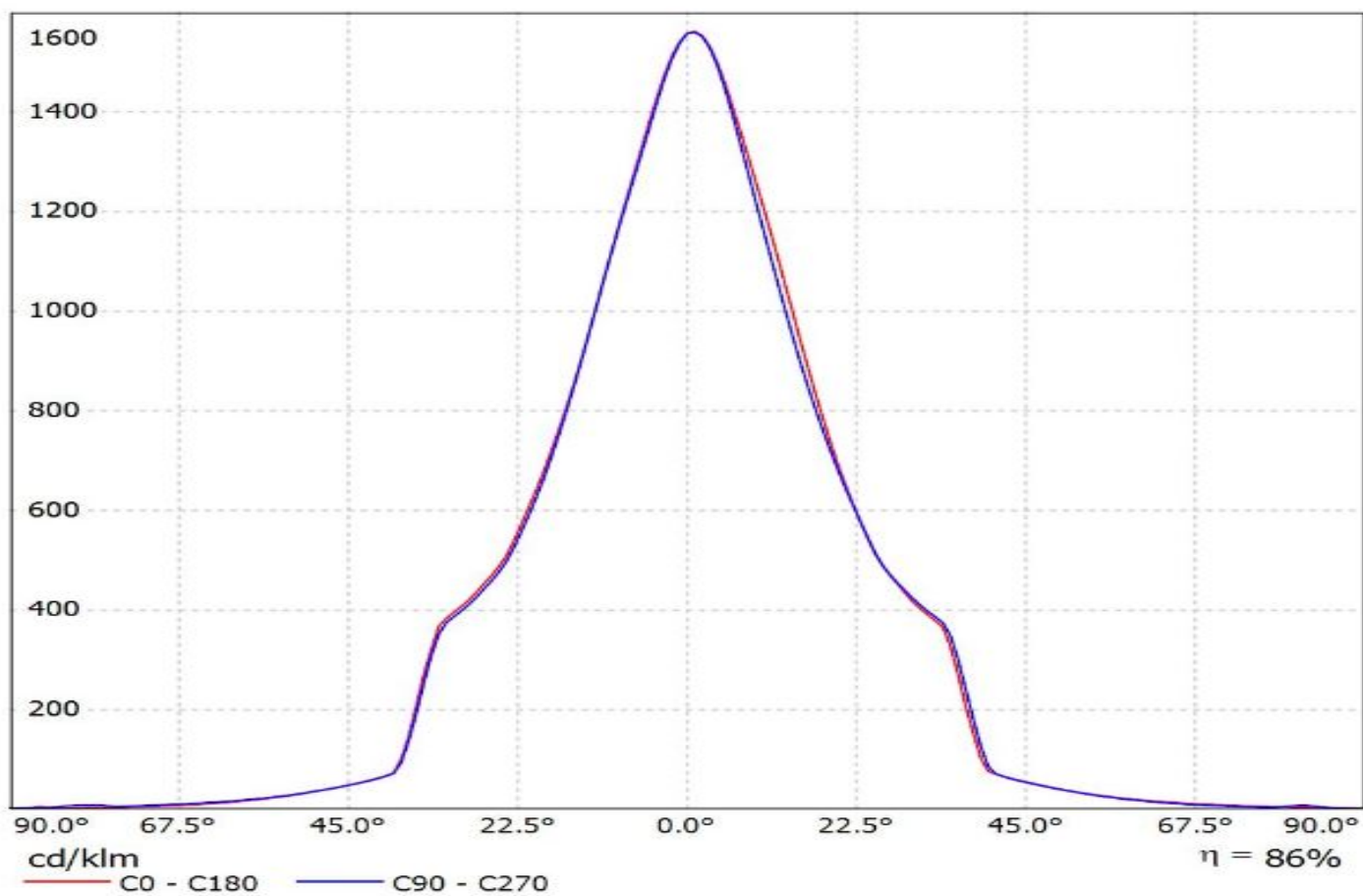

Ledil FCN13707_ANGELA-W_(Soleriq_S13) / LDC (Linear)

Luminaire: Ledil FCN13707_ANGELA-W_(Soleriq_S13)

Lamps: 1 x Osram_Soleriq_S13_(GW_KAGHB1.EM)_896.727lm@250mA_P=7.44679W_I=250mA

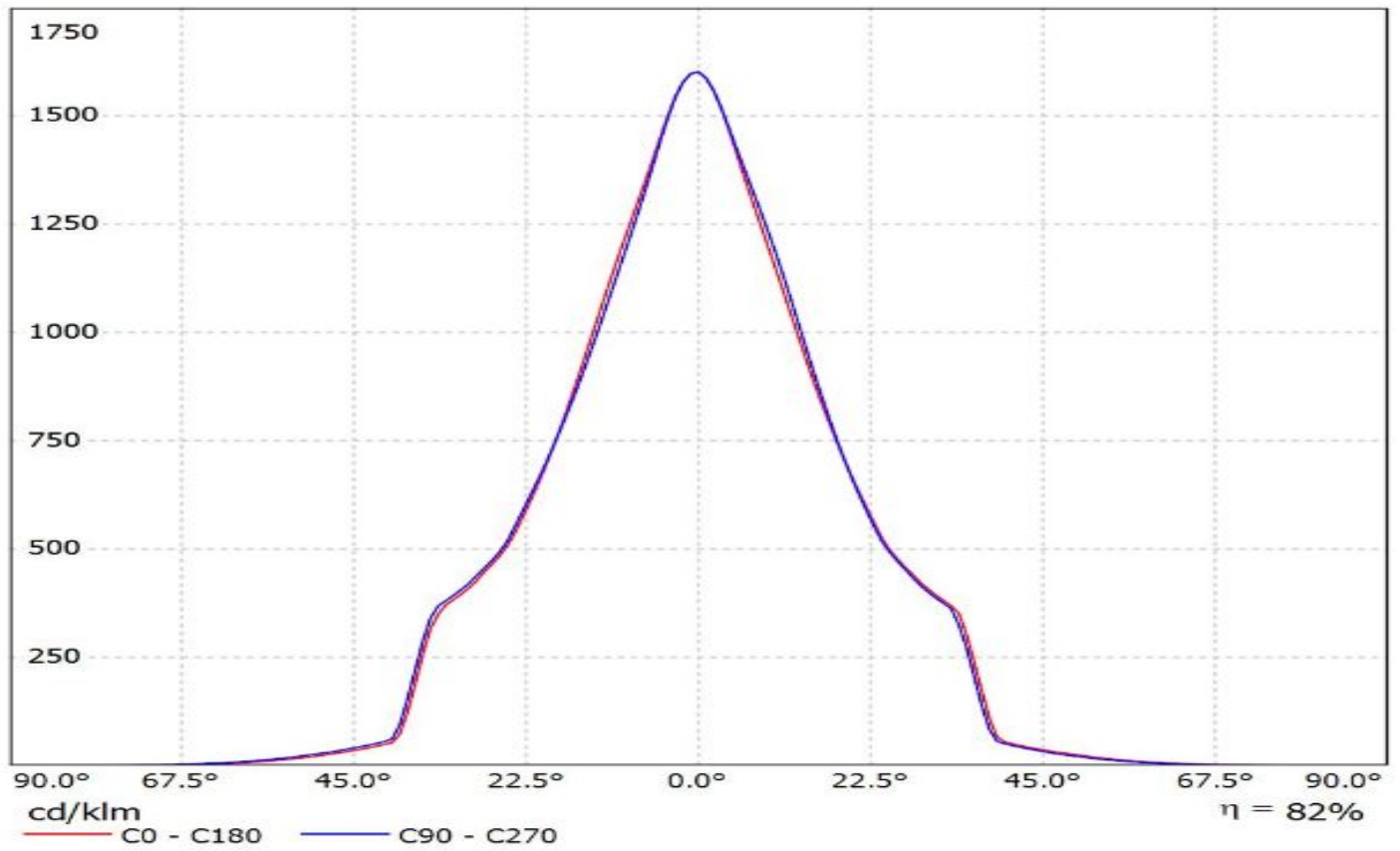

Luminaire: Ledil FCN13707_ANGELA-W_(450_Typ_L2)_(C13658_CLAMP-VERO13-18)_(LC040B)
Lamps: 1 x Samsung_LC040B_CCT=3000K_(SPHWW1HDNE25010101)_(450_Typ_L2)_(C13658_CLAMP-VERO13-18)_1109.31lm@250mA_P=8.2W_I=0.25A

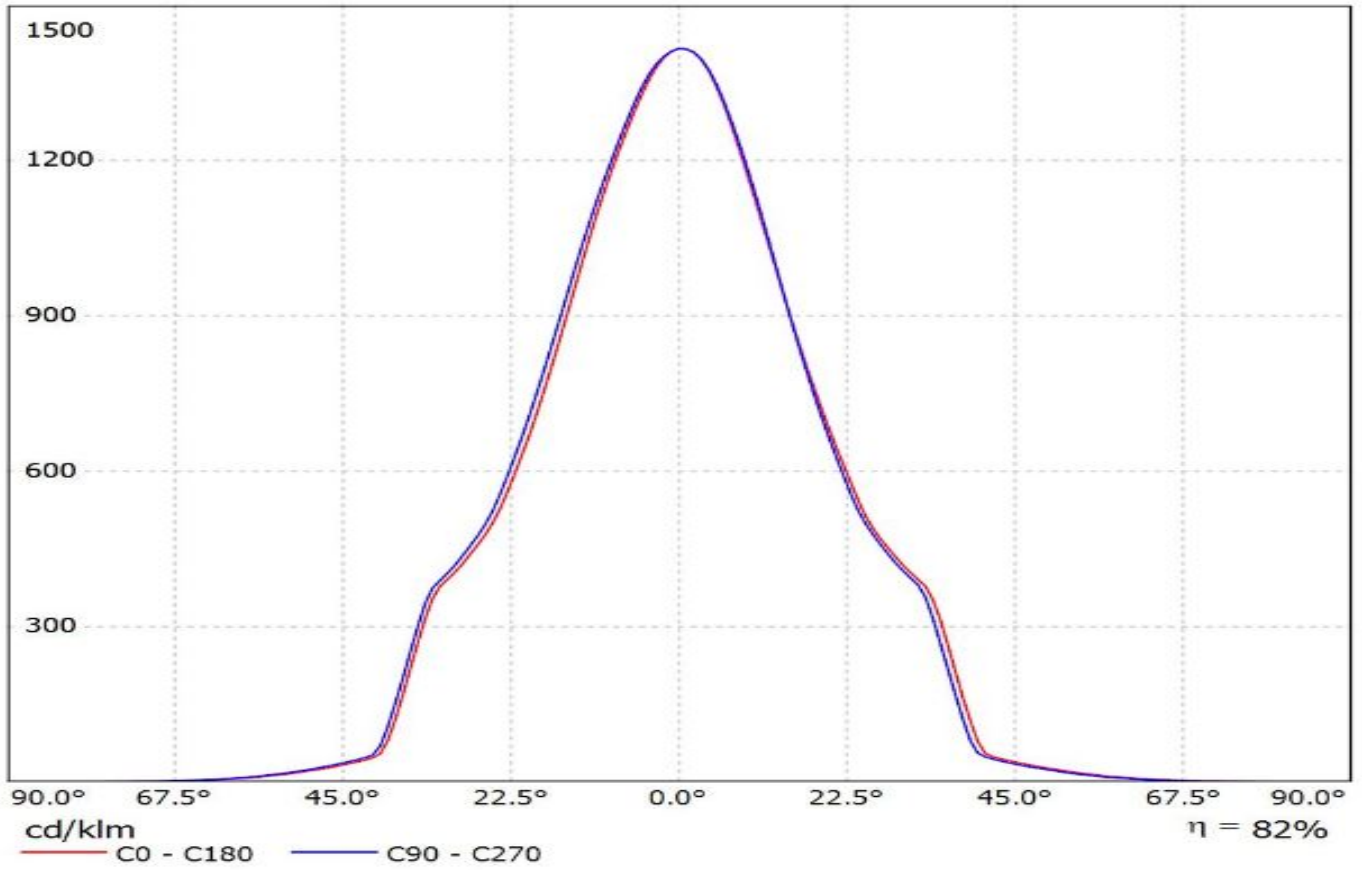

Luminaire: LEDiL Oy FCN13707_ANGELA-W_(SLE-G5_LES-11)
Lamps: 1 x Tridonic_SLE-G5_LES-11_1137.55lm@250mA_P=8.4177W_I=0.250A

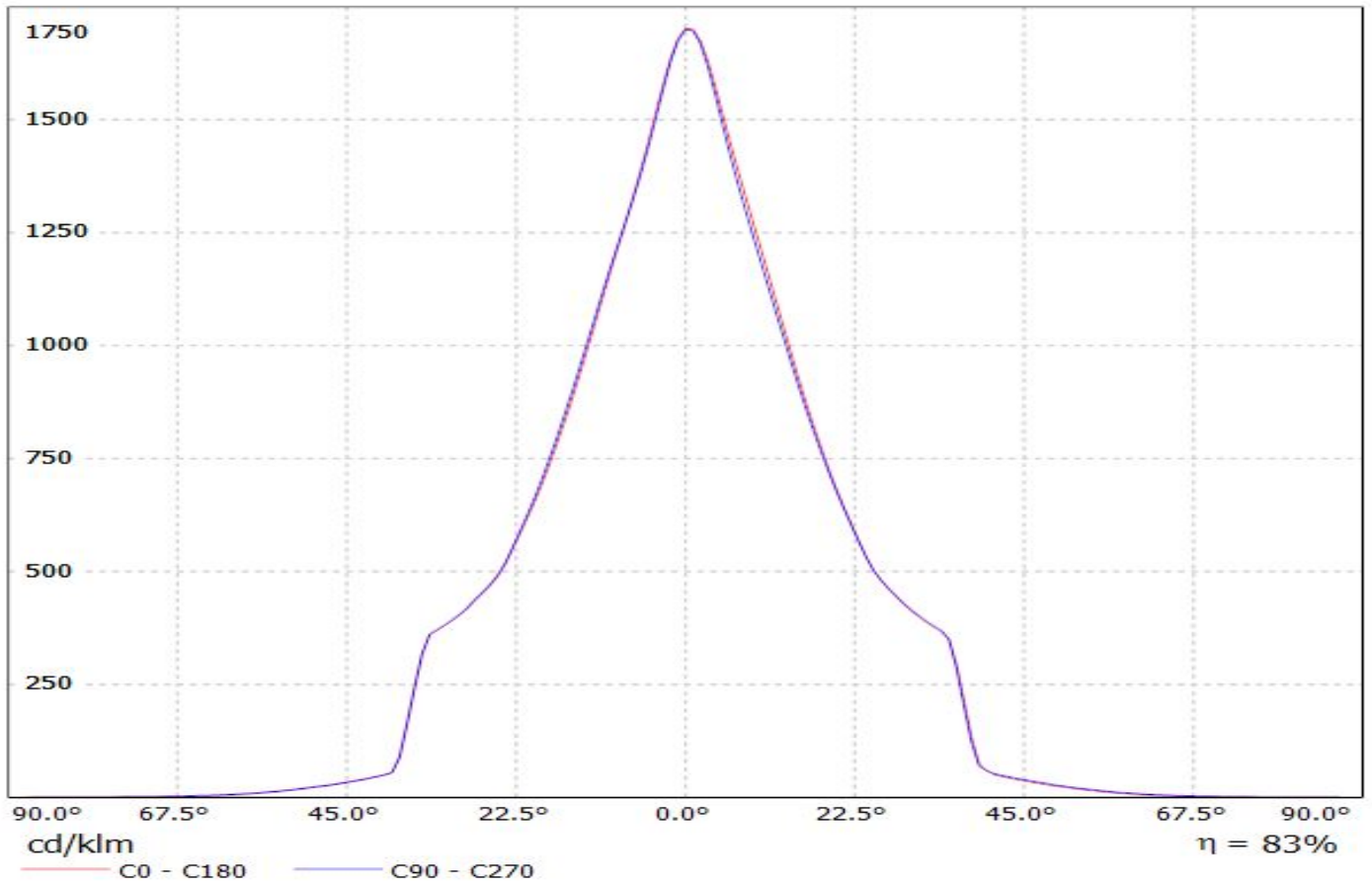

Luminaire: LEDiL Oy FCN13707_ANGELA-W_(Vero18) Eff.83.9%

Lamps: 1 x VERO18_(BXRC30E4000F)_882.261lm@250mA P=6.73161W I=249.8mA

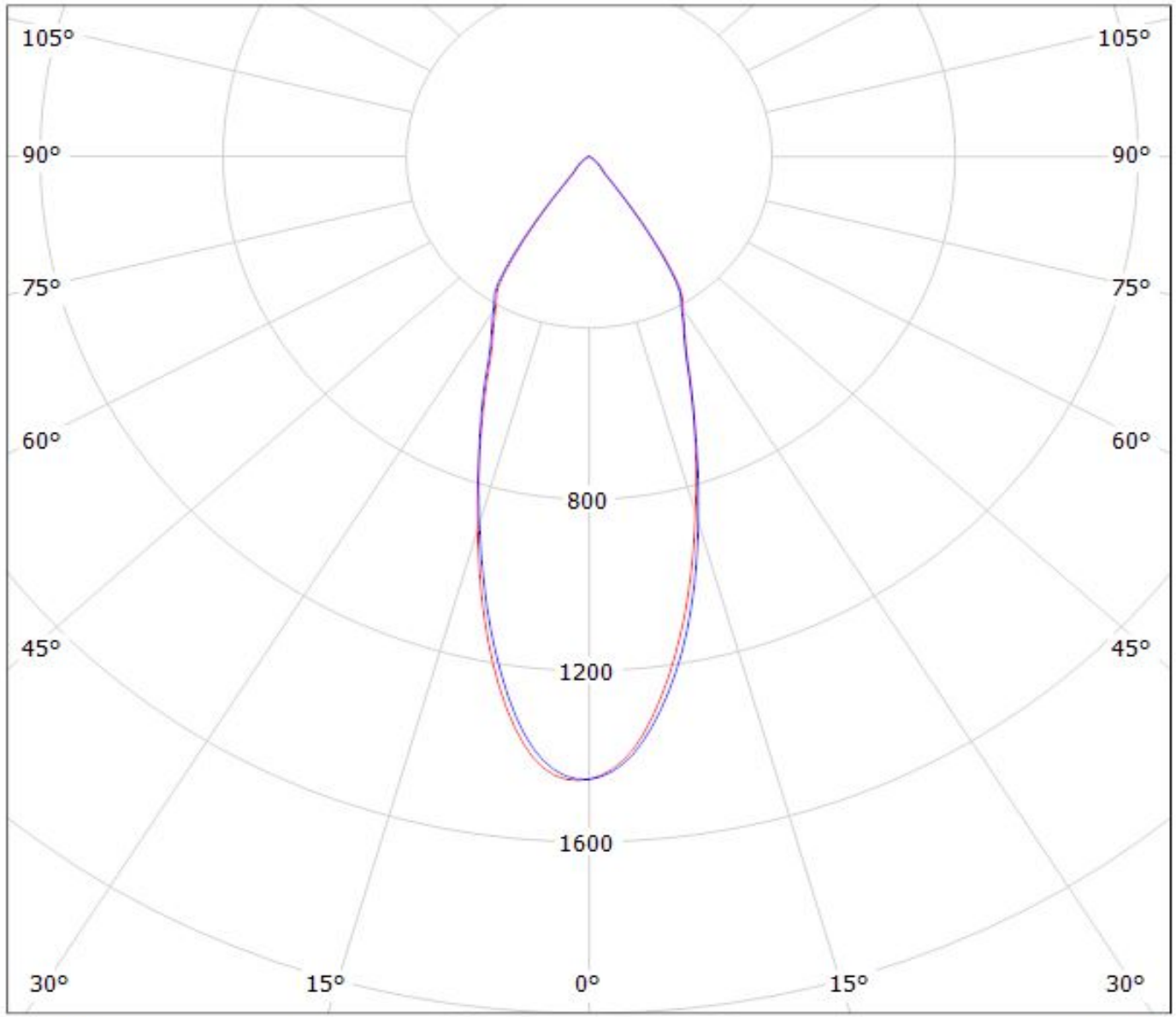

cd/klm

— C0 - C180 — C90 - C270

$\eta = 84\%$

Luminaire: LEDiL Oy FCN13707_ANGELA-W_(VERO13) Eff.86.2%
Lamps: 1 x Bridgelux_VERO13_(BXRC-30E2000C)_1065.05lm@250mA_P=7.63813W_I=249.8mA

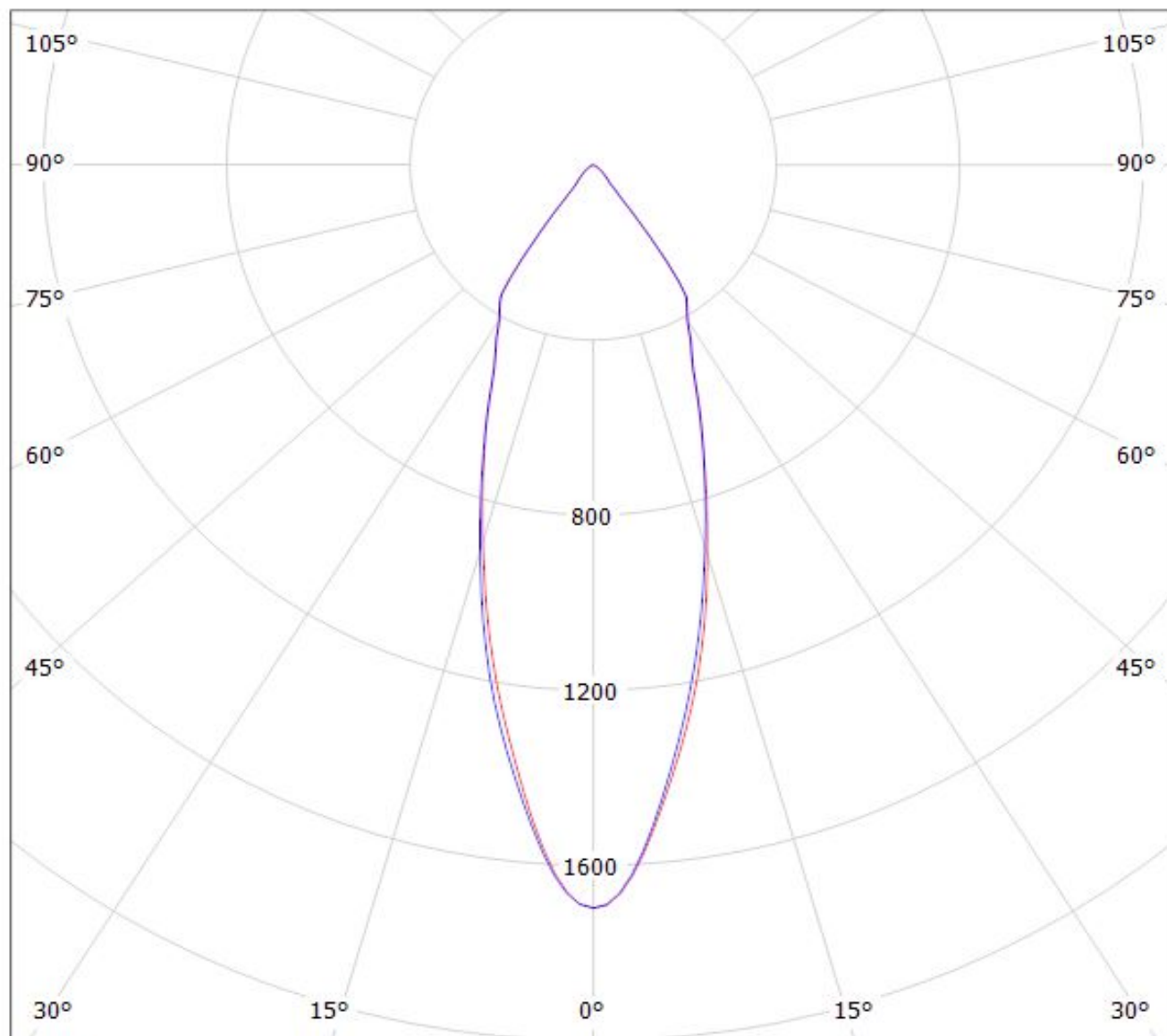

cd/klm

— C0 - C180

— C90 - C270

$\eta = 86\%$

Luminaire: Ledil Oy FCN13707_ANGELA-W+_B+W_434_TypL1_BRIDGELUX_V10_Gen7_SIMULATED
Lamps: 1 x BRIDGELUX V10 Gen7

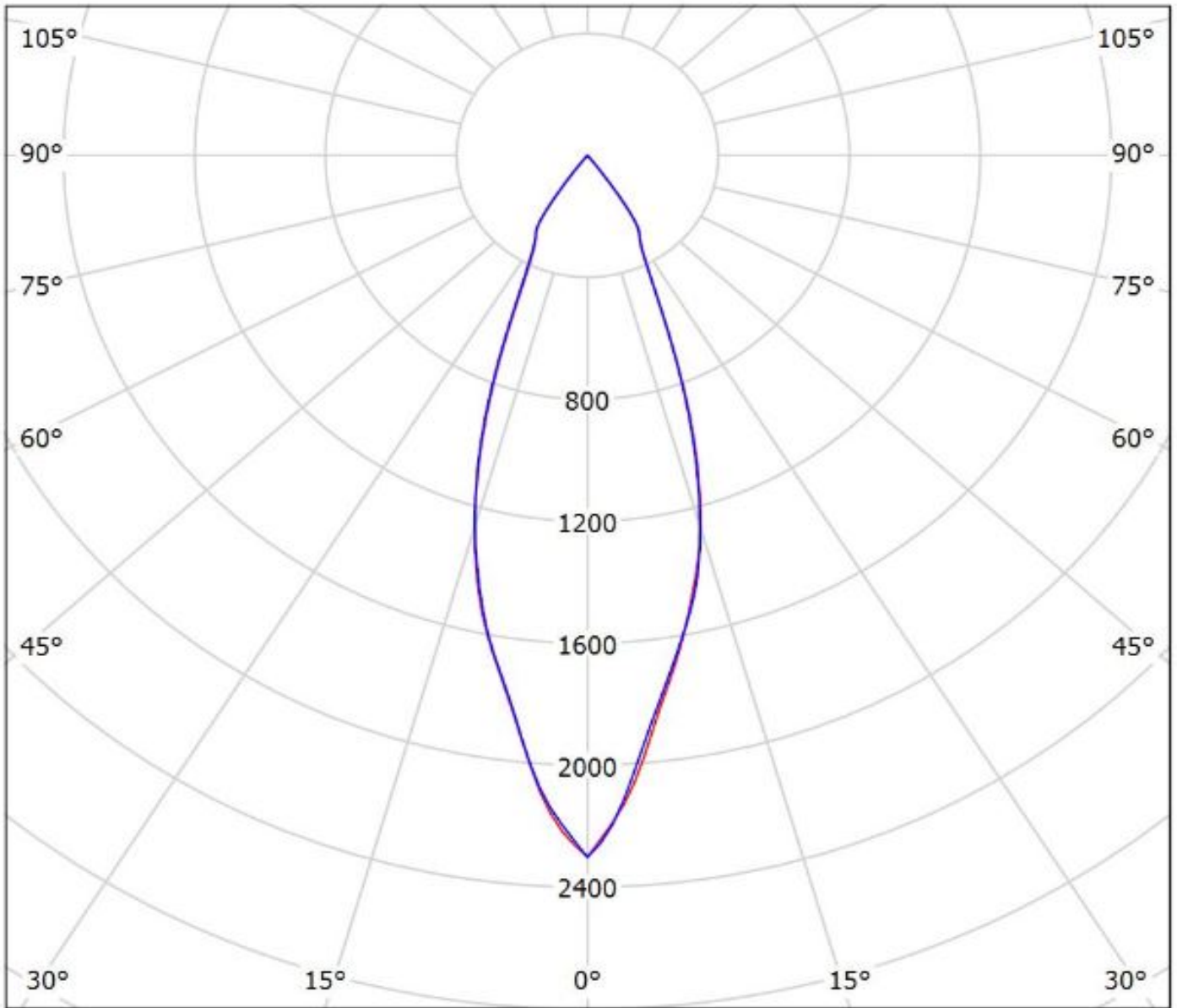

cd/klm
— C0 - C180 — C90 - C270

$\eta = 89\%$

Ledil FCN13707_ANGELA-W_(CLU720)_(433_Typ_L1) / LDC (Polar)

Luminaire: Ledil FCN13707_ANGELA-W_(CLU720)_(433_Typ_L1)

Lamps: 1 x Citizen_CLU720_(CLU720-1206B8-273M2G1)_1225.89lm@250mA_P=8.3W_I=0.25A

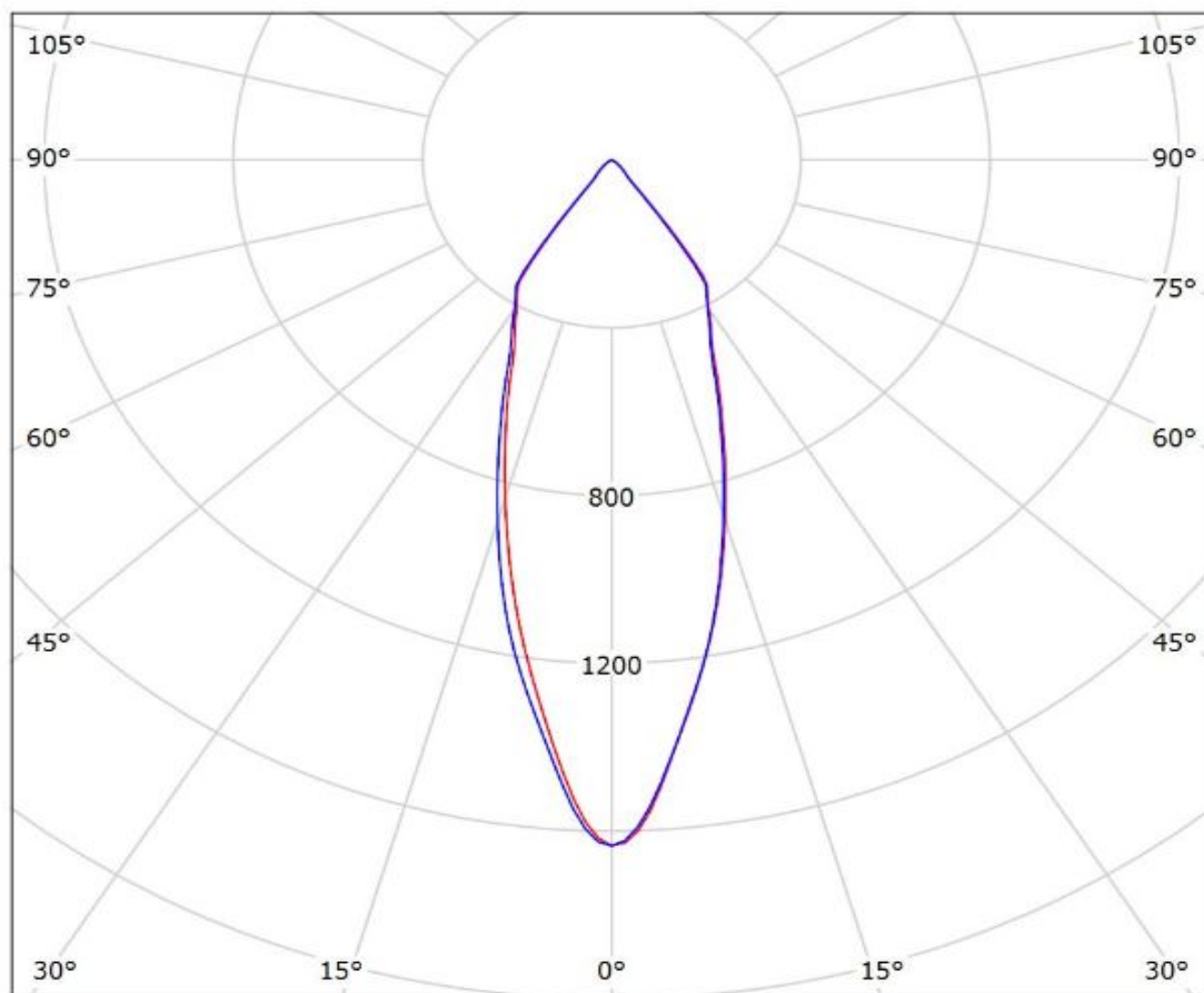

$\eta = 82\%$

— C0 - C180 — C90 - C270