



Chipsmall Limited consists of a professional team with an average of over 10 year of expertise in the distribution of electronic components. Based in Hongkong, we have already established firm and mutual-benefit business relationships with customers from,Europe,America and south Asia,supplying obsolete and hard-to-find components to meet their specific needs.

With the principle of “Quality Parts,Customers Priority,Honest Operation,and Considerate Service”,our business mainly focus on the distribution of electronic components. Line cards we deal with include Microchip,ALPS,ROHM,Xilinx,Pulse,ON,Everlight and Freescale. Main products comprise IC,Modules,Potentiometer,IC Socket,Relay,Connector.Our parts cover such applications as commercial,industrial, and automotives areas.

We are looking forward to setting up business relationship with you and hope to provide you with the best service and solution. Let us make a better world for our industry!



Contact us

Tel: +86-755-8981 8866 Fax: +86-755-8427 6832

Email & Skype: info@chipsmall.com Web: www.chipsmall.com

Address: A1208, Overseas Decoration Building, #122 Zhenhua RD., Futian, Shenzhen, China



DETAILS

Product Number	FCN13925_BARBARA-S-PF-VERO13/18
Family	Barbara
Type	RefPack
Color	metal
Diameter	70 mm
Height	41,7 mm
Style	round
Optic Material	
Holder Material	
Fastening	
Status	production ready
ROHS Compliant	Yes
Date Updated	6/03/2017



OPTICAL PROPERTIES

LED	Viewing Angle	Light Beam	Efficiency	cd/lm	Connector
VERO13	15 deg	Spot	91 %	6.800	-
VERO18	22 deg	Spot	91 %	3.600	-
V15 Gen6	18 deg	Spot	92 %	4.750	Bender Wirth: 456 Typ L2
V8 Gen6	13 deg	Spot	86 %	10.600	Bender Wirth: 460 Typ L1
Xenio Point 13mm	14 deg	Spot	91 %	6.640	LEDiL: LEDiL
Xenio Point 18mm	21 deg	Spot	86 %	3.230	LEDiL: LEDiL
V10 Gen7	sim: 12	Spot	sim: 91 %	sim: 9.440	Bender Wirth: 434 Typ L1
CLL03x/CLU03x	16 deg	Spot	88 %	5.100	Bender Wirth: 433 Typ L1
CLU720/721	14 deg	Spot	87 %	7.300	Bender Wirth: 433 Typ L1
CLL02x/CLU02x (LES10)	12 deg	Spot	89 %	9.200	Bender Wirth: 434 Typ L1
CXA/B 1816 & CXA/B 1820 & CXA 1850	14 deg	Spot	86 %	6.100	Bender Wirth: 437 Typ L1
CXA/B 15xx	15 deg	Spot	89 %	6.900	Bender Wirth: 441 Typ L1
LUXEON CoB 1202/1203	14 deg	Spot	88 %	7.300	Bender Wirth: 438 Typ L1
CXM-14	sim: 16	Spot	sim: 88 %	sim: 5.130	Bender Wirth: 433 Typ L1
CXM-9	sim: 12	Spot	sim: 89 %	sim: 9.200	Bender Wirth: 434 Typ L1
COB L-Type (LES 9)	13 deg	Spot	90 %	8.400	Bender Wirth: 438 Typ L1
COB L-Type (LES 11)	14 deg	Spot	86 %	6.100	Bender Wirth: 438 Typ L1
COB J-Type	17 deg	Spot	88 %	4.600	Bender Wirth: 463 Typ L2
Soleriq P9	12 deg	Spot	92 %	9.600	Bender Wirth: 461 Typ L1
Soleriq P13	16 deg	Spot	91 %	5.400	Bender Wirth: 437 Typ L1
Soleriq P6	12 deg	Spot	89 %	12.000	Bender Wirth: 446 Typ L1
Soleriq S13	14 deg	Spot	89 %	6.200	Bender Wirth: 437 Typ L1
Soleriq S15	sim: 20	Spot	sim: 88 %	sim: 4.013	Bender Wirth: 433 Typ L1
LC026B/LC040B	20 deg	Spot	88 %	3.700	Bender Wirth: 450 Typ L2
LC020C	sim: 10	Spot	sim: 89 %	sim: 12.300	Bender Wirth: 479 Typ L1



PRODUCT DATASHEET

Barbara series

last update 6/3/2017

OPTICAL PROPERTIES

LED	Viewing Angle	Light Beam	Efficiency	cd/lm	Connector
LC010C	sim: 9,1	Spot	sim: 89 %	sim: 16.300	Bender Wirth: 479 Typ L1
LC040C	sim: 13	Spot	sim: 85 %	sim: 7.300	Bender Wirth: 480 Typ L1
ZC12/18	sim: 16	Spot	sim: 88 %	sim: 5.100	Bender Wirth: 433 Typ L1
ZC4/6	sim: 12	Spot	sim: 89 %	sim: 9.200	Bender Wirth: 434 Typ L1
SLE G5 LES11	13 deg	Spot	91 %	8.500	Bender Wirth: 434 Typ L1

Relative intensity of FCN13925_BARBARA-S-PF-VERO13_18_(V15)

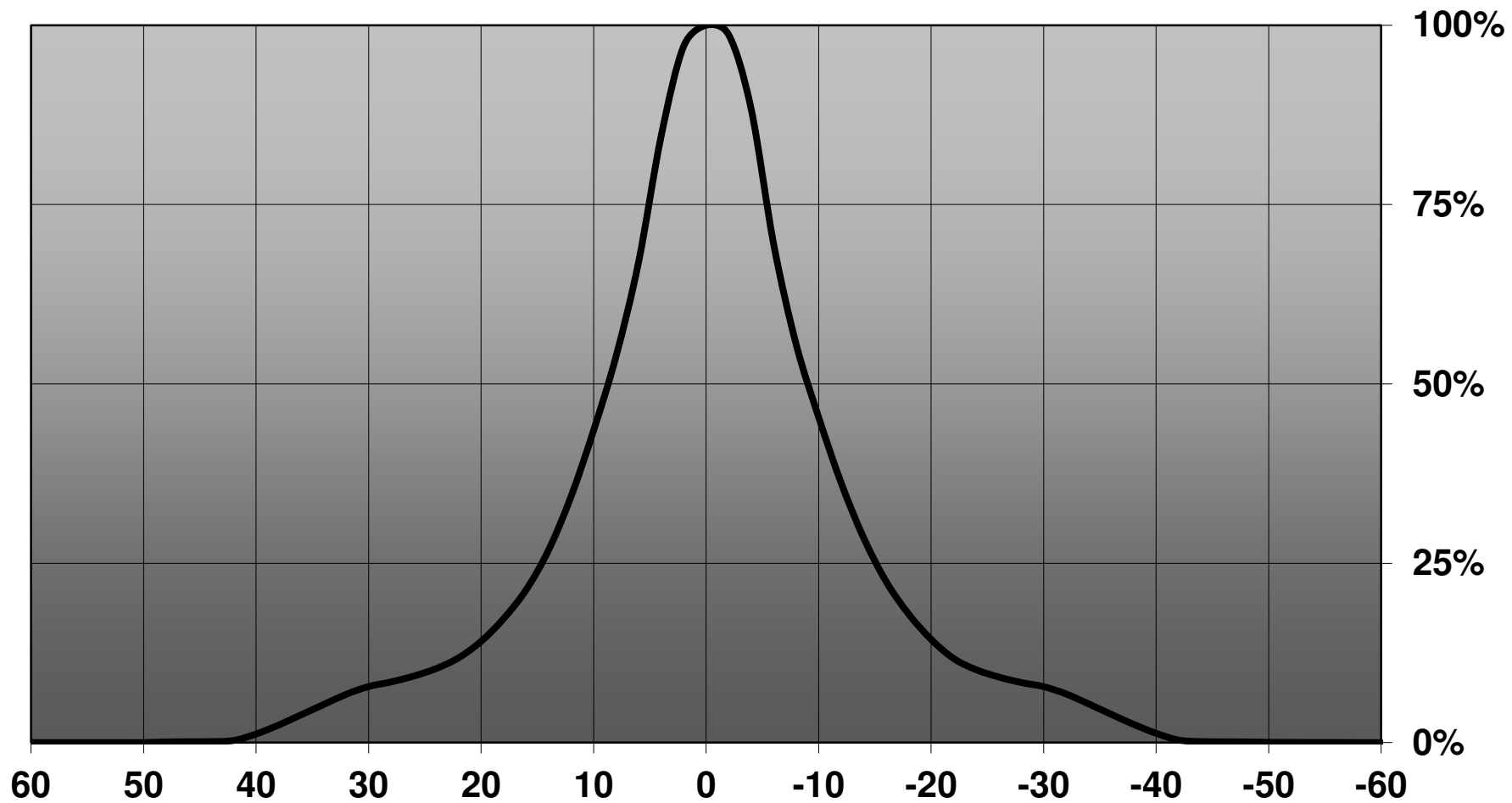

Relative intensity of FCN13925_BARBARA-S-PF-VERO13_18_(V8)

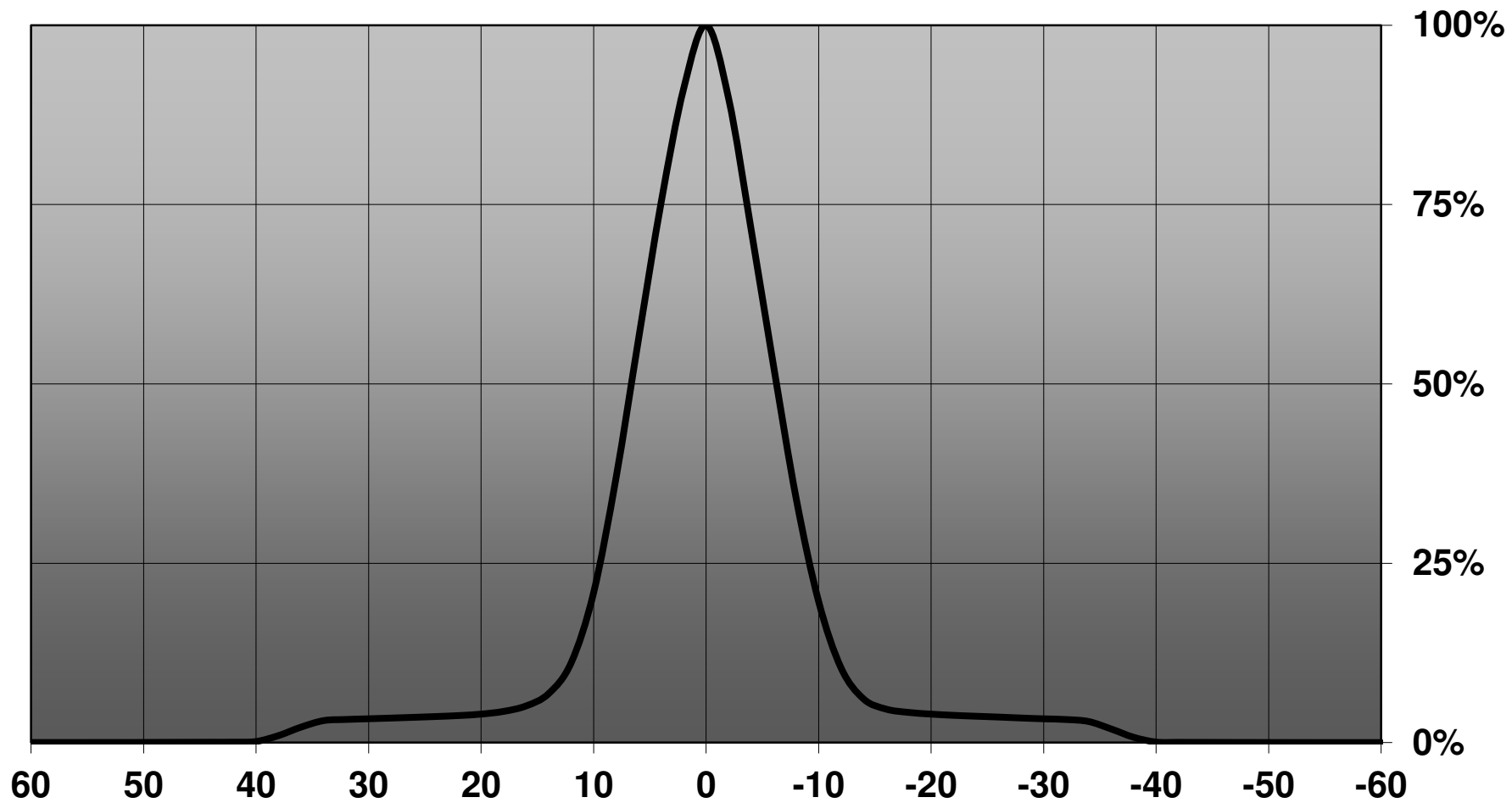

H G F E D C B A

4

3

2

1

4

3

2

1

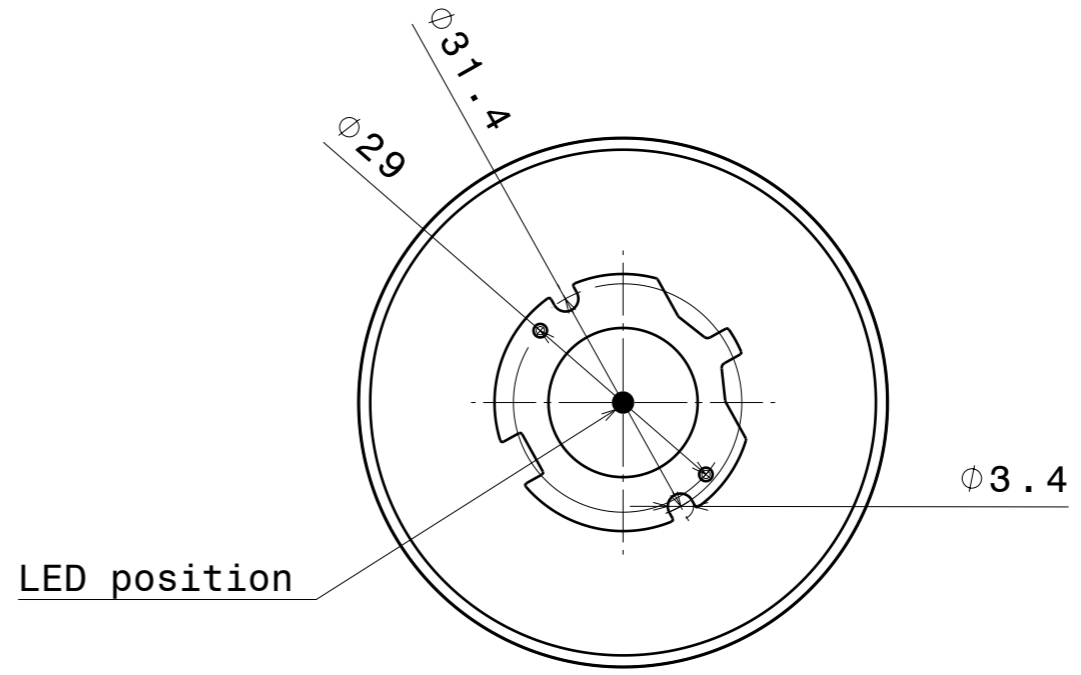
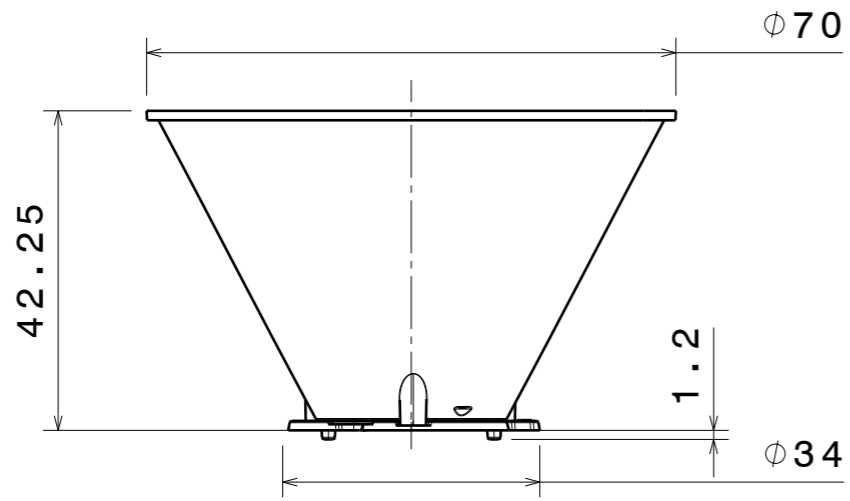

LED position

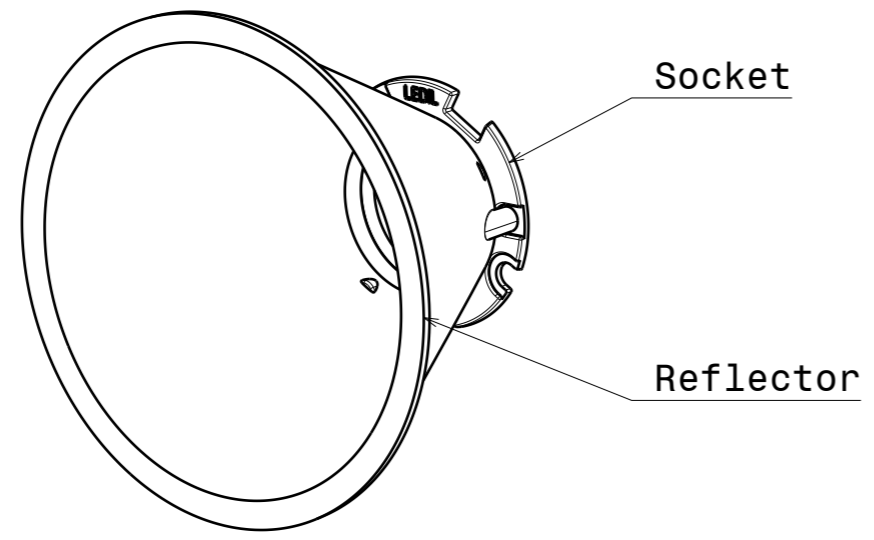

Socket

Reflector

INDEX	PART NO	MATERIAL	COLOUR
1	Socket	PC	White
2	Reflector	PC	Metal

Tolerances if not otherwise shown
 According to DIN ISO 2768-1
 Linear measures: class C
 According to DIN ISO 2768-2
 Form and position: class L

LEDiL LediL Oy
 Salorankatu 10
 FIN 24240 SALO
 Finland

THIRD ANGLE PROJECTION:

DRAWING TITLE **DATA SHEET BARBARA-PF SOCKET-VERO13-18**

This drawing is the property of LEDiL Oy. It may not be reproduced, copied or communicated without a written agreement with LEDiL Oy.

SIZE **A3** PART NUMBER -

SCALE 1:1 WEIGHT - SHEET 1/1

H G B A

Luminaire: LEDil Oy FCN13925_BARBARA-S-PF-VERO1318_(VERO13) Efficiency=91%
Lamps: 1 x Bridgelux VERO13 (BXRC-40E2000C) 1046lm @ 250mA CCT=4000K P=7.6W I=250mA

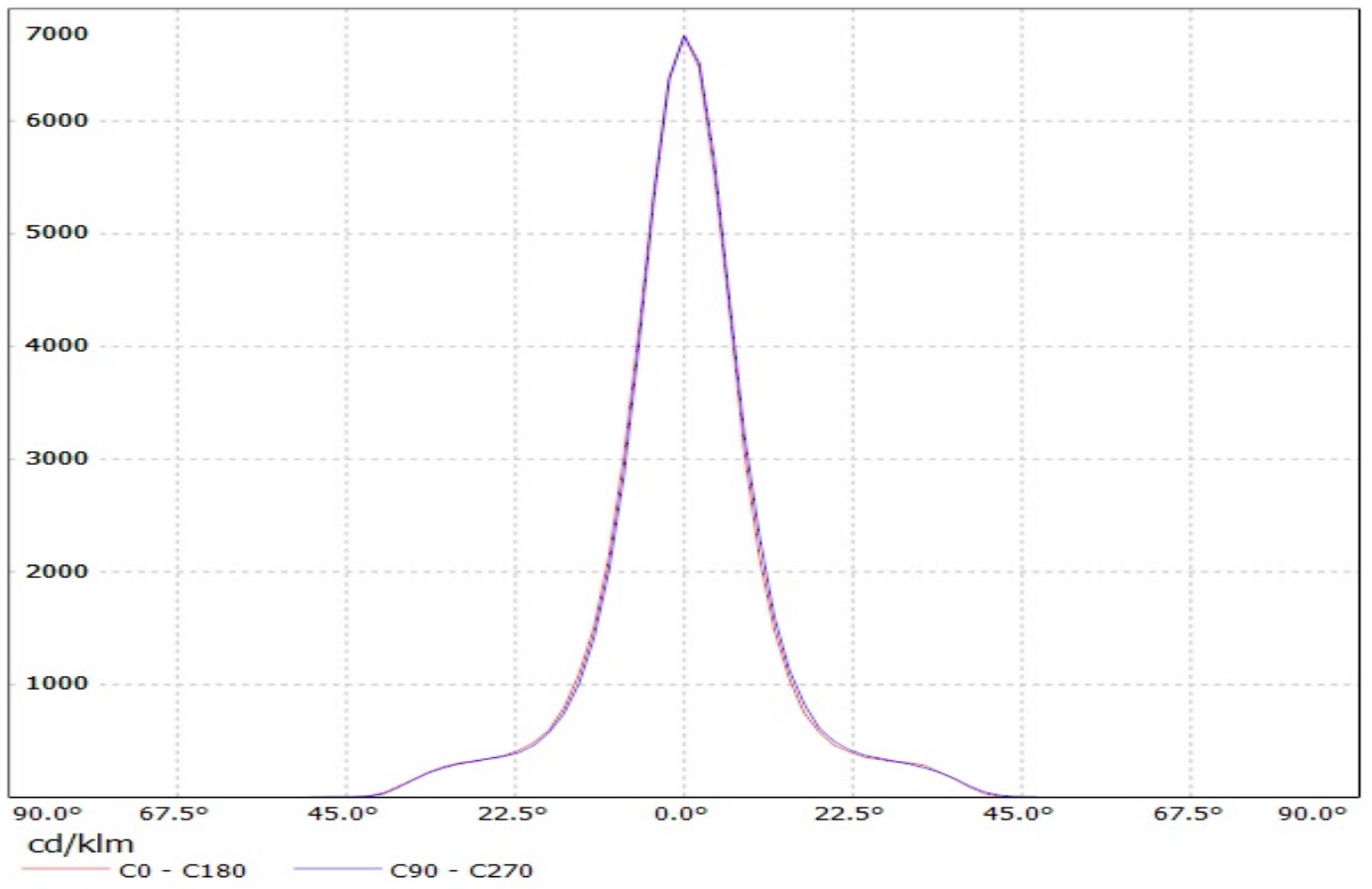

Luminaire: LEDil Oy FCN13925_BARBARA-S-PF-VERO1318_(VERO18) Efficiency=91%
Lamps: 1 x Bridgelux VERO18 (BXRC-30E4000F) 877lm @ 250mA CCT=3200K P=6.8W I=250mA

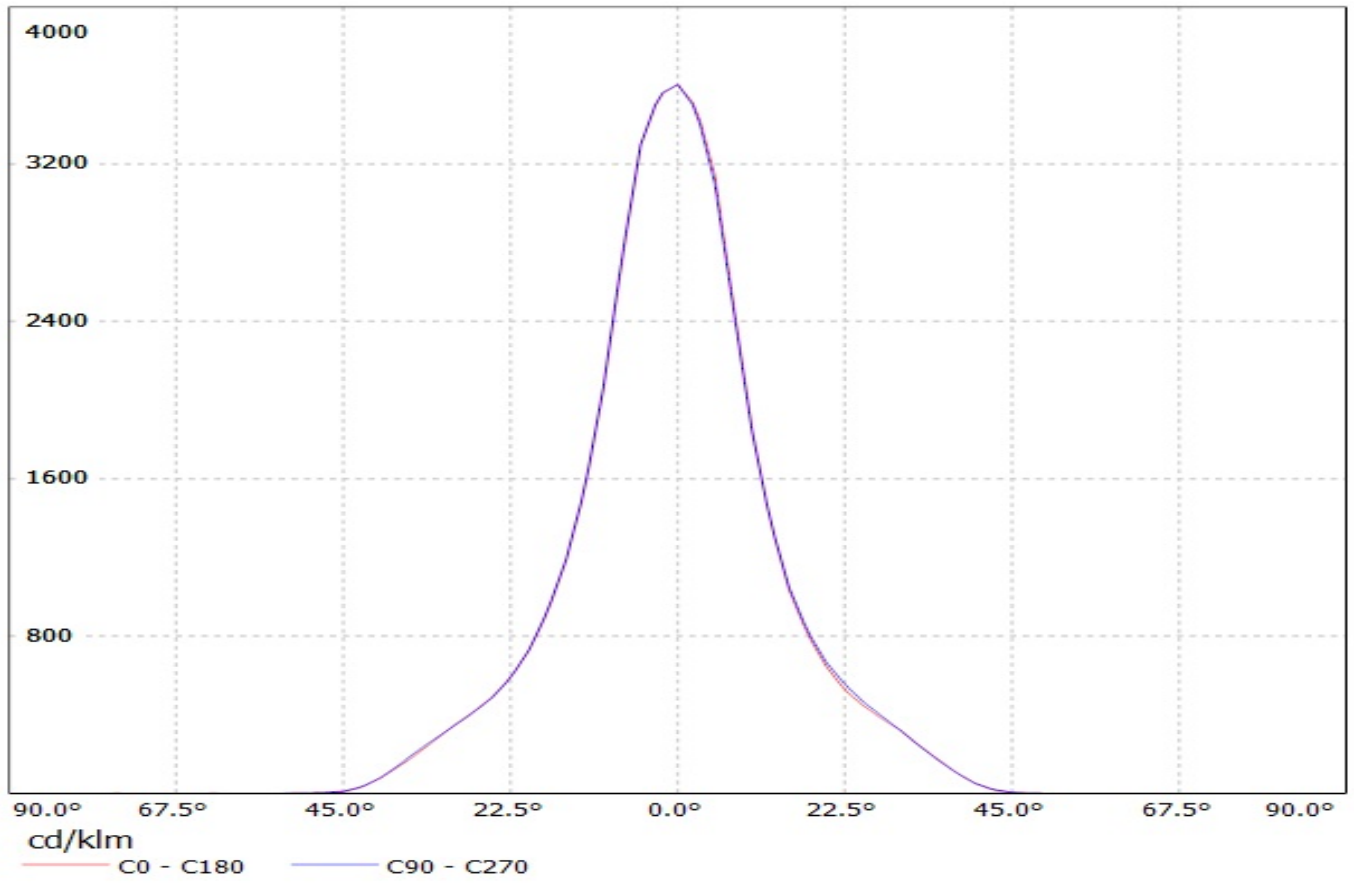

Luminaire: LEDiL Oy FCN13925_BARBARA-S-PF-VERO13/18_(XENIO_13MM)
Lamps: 1 x XENIO_13MM_2074.66lm@?mA_P=23W_I=?A

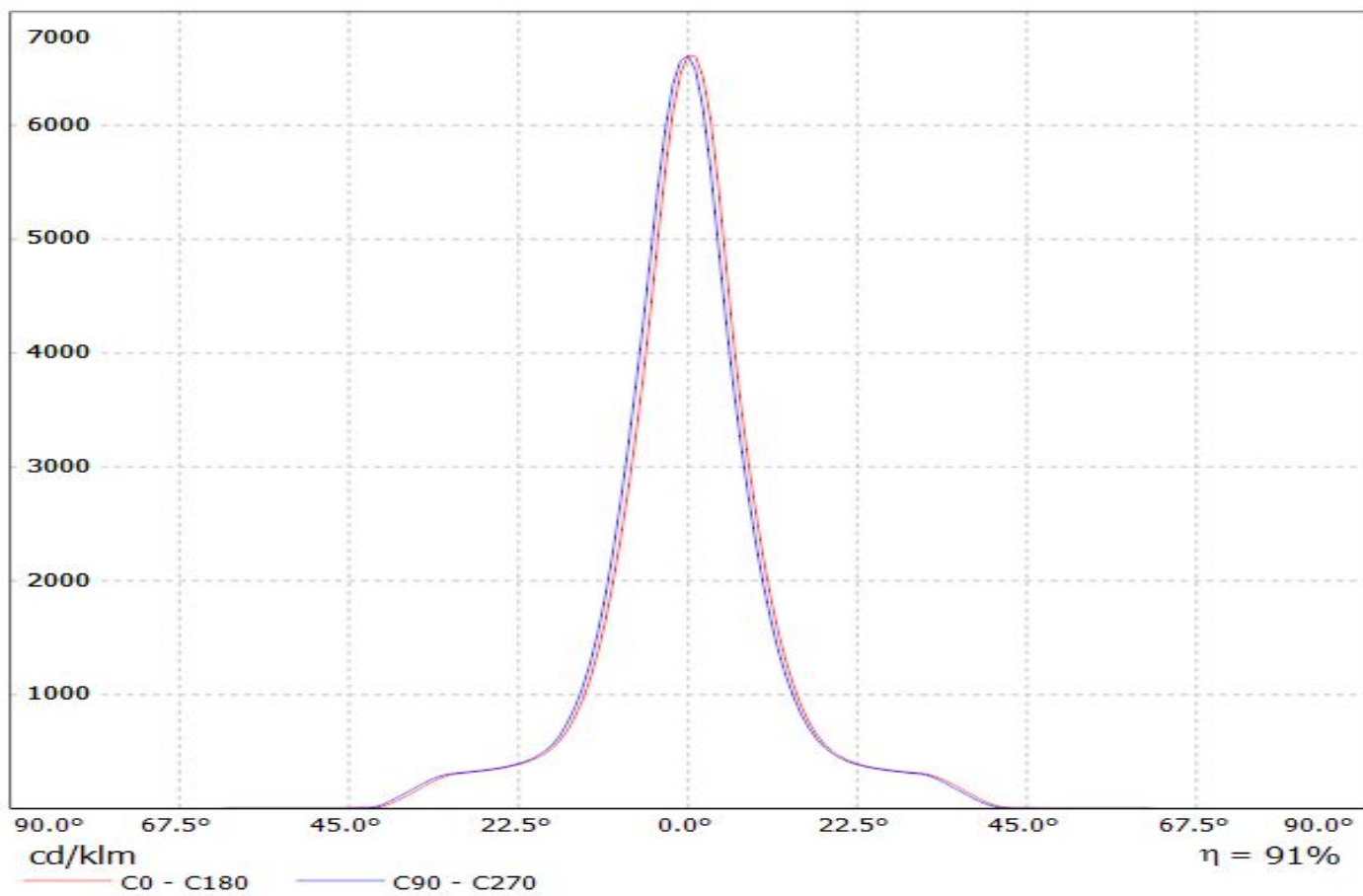

Luminaire: LEDiL Oy FCN13925_BARBARA-S-PF-VERO13/18_(Xenio_18mm)
Lamps: 1 x Xenio_18mm_3761.62lm@?mA_P=43W_I=?A

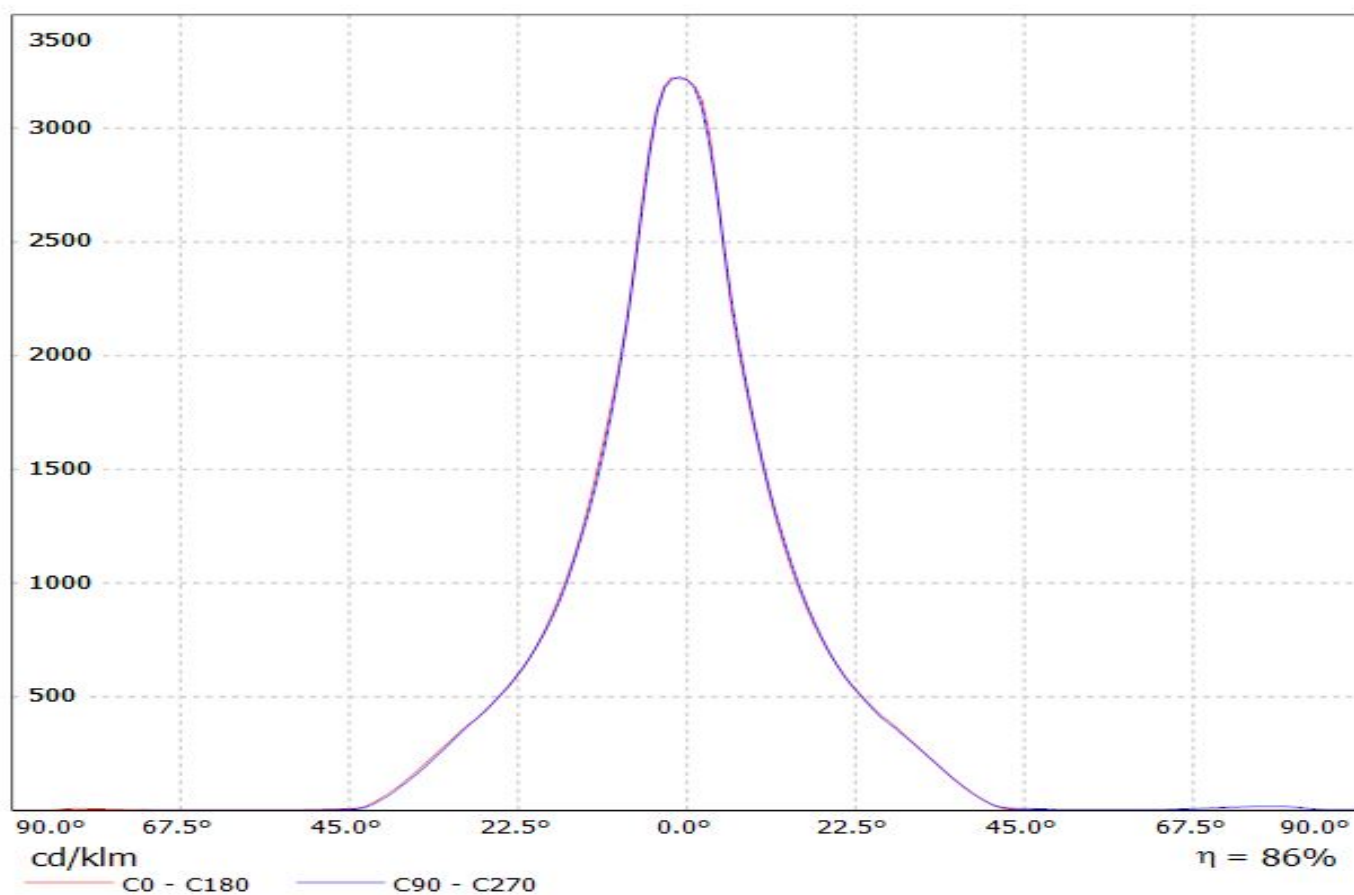

Luminaire: Ledil Oy FCN13925_BARBARA-S-PF-VERO13-18+_B+W_434_TypL1_BRIDGELUX_V10_Gen7
Lamps: 1 x BRIDGELUX V10 Gen7

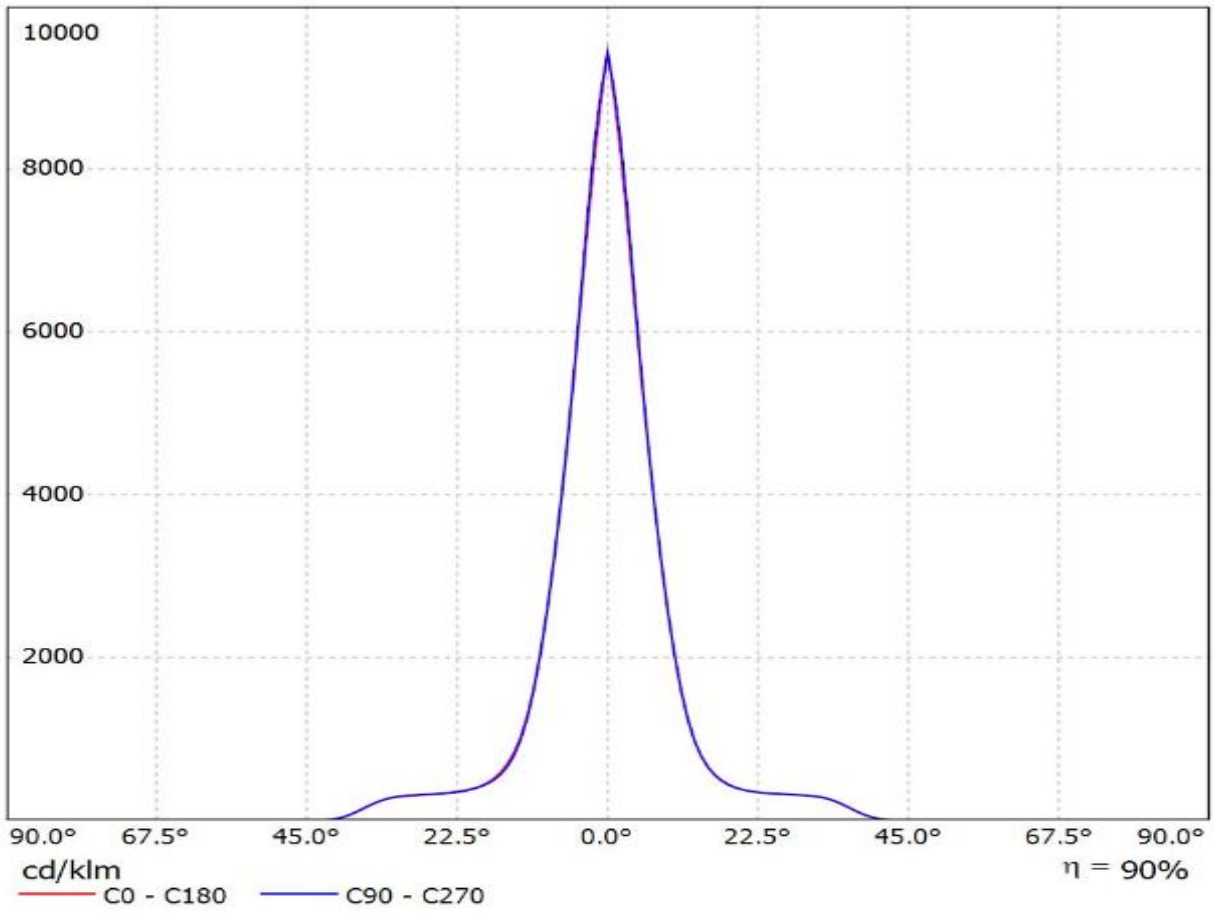

Luminaire: Ledil FCN13925_BARBARA-S-PF-VERO13-18_(CLU034)_(433_Typ_L1)
Lamps: 1 x Citizen_CLU034_(CLU034-1205B8-303M1A2)_1180.79lm@250mA_P=8.50075W_I=0.25A

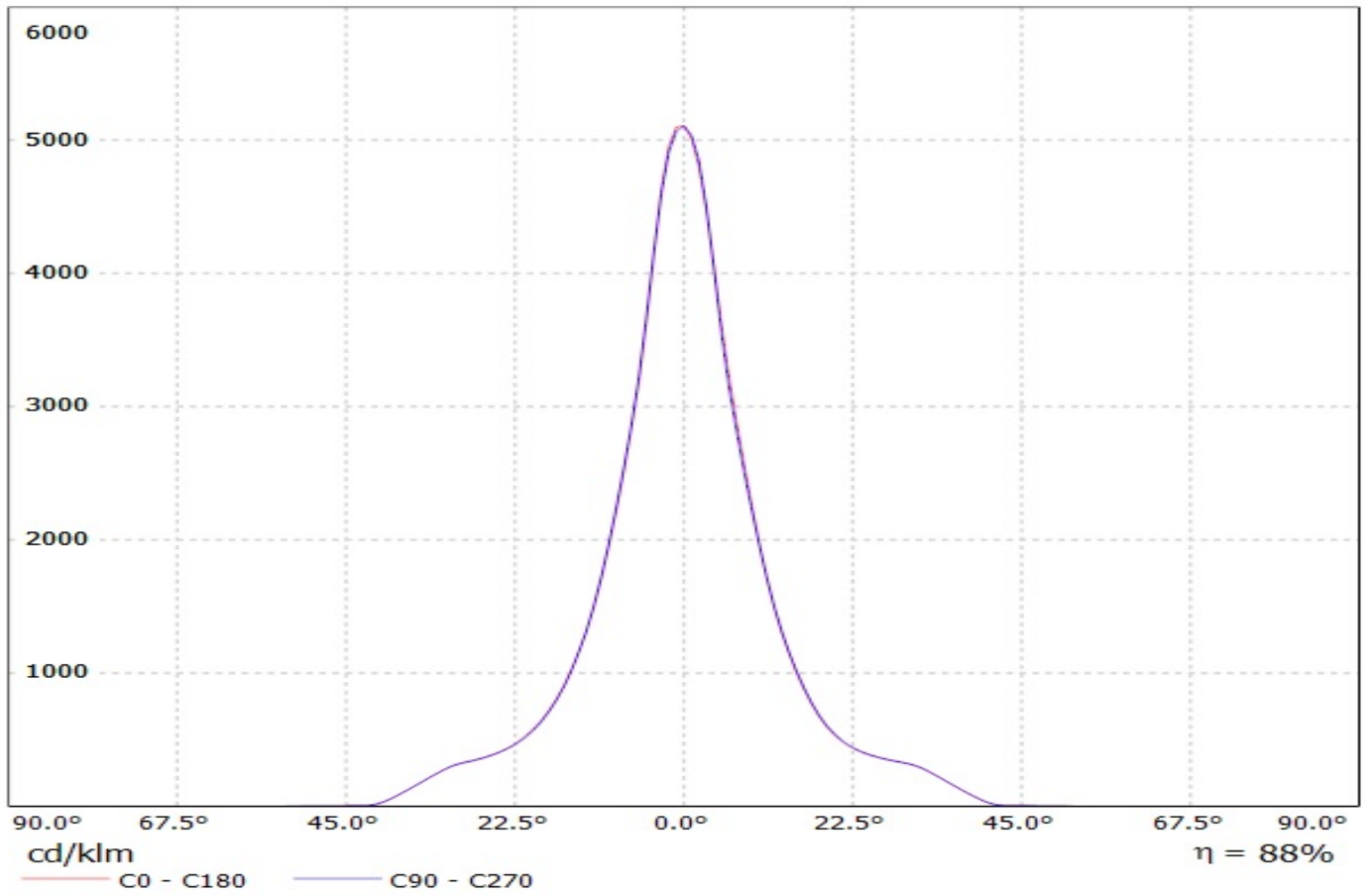

Ledil FCN13925_BARBARA-S-PF-VERO13/18_(CLU720) / LDC (Linear)

Luminaire: Ledil FCN13925_BARBARA-S-PF-VERO13/18_(CLU720)

Lamps: 1 x Citizen_CLU720_(433_Typ_L1)_(C13709)_1233.32lm@250mA_P=8.3W_I=0.25A

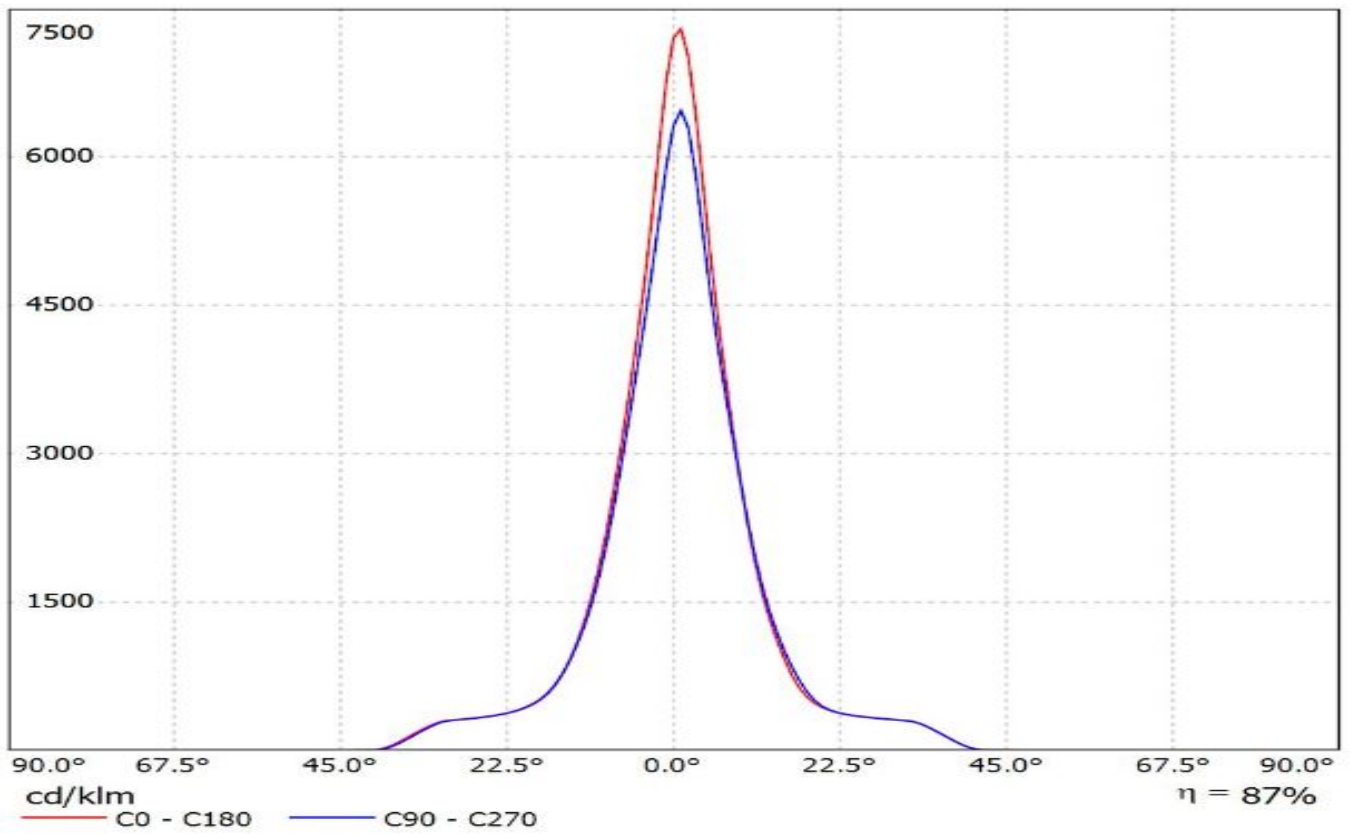

Luminaire: Ledil FCN13925_BARBARA-S-PF-VERO13/18_(CLU024) Citizen_CLU024_(434_Typ_L1)_
(C13709_PF-SOCKET-VERO13-18)_1065.5lm@250mA_P=8.55W_I=0.25A
Lamps: 1 x Citizen_CLU024_(434_Typ_L1)_ (C13709_PF-SOCKET-VERO13-18)
_1065.5lm@250mA_P=8.55W_I=0.25A

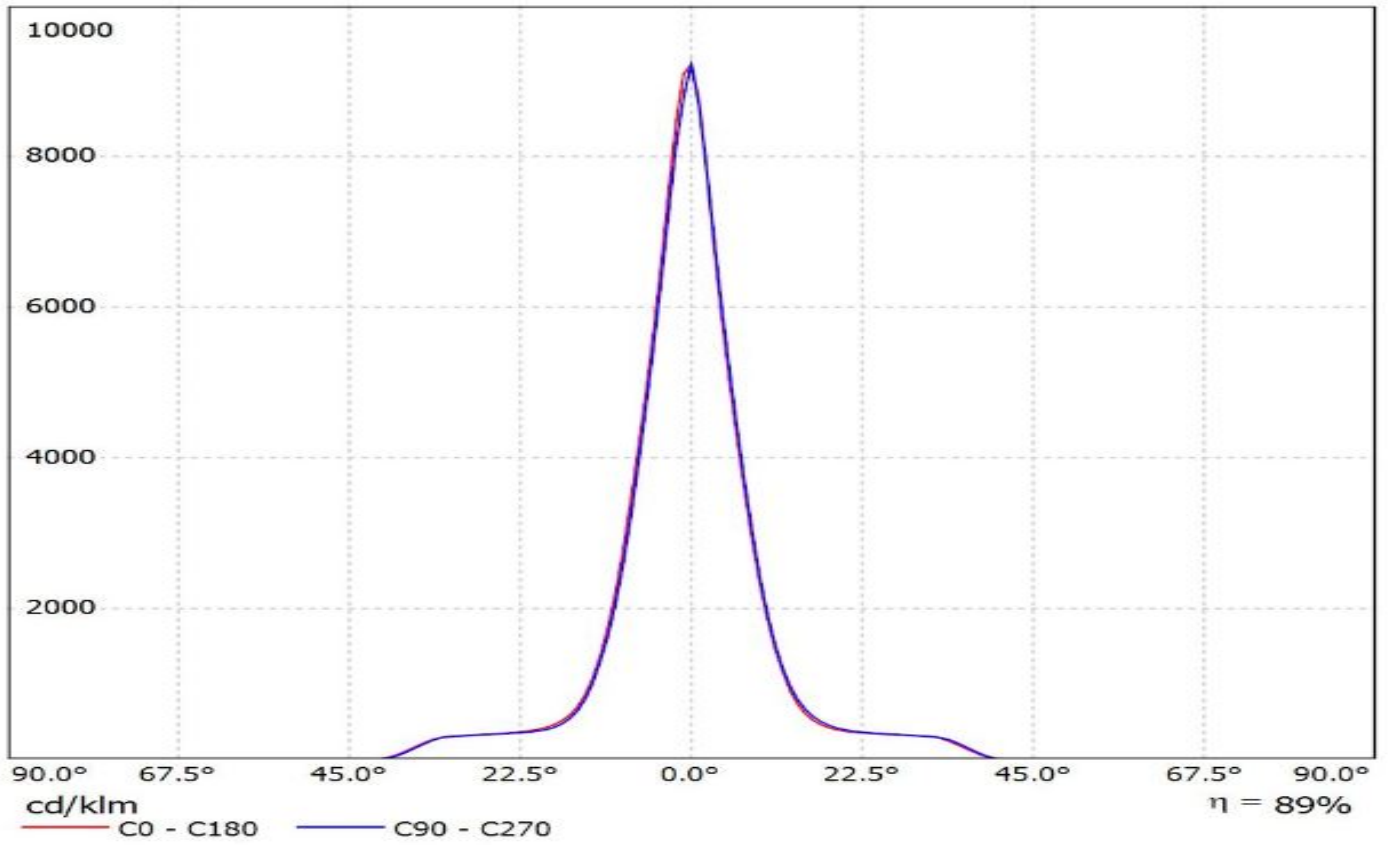

Ledil FCN13925_BARBARA-S-PF-VERO13-18_(CXA1850) / LDC (Linear)

Luminaire: Ledil FCN13925_BARBARA-S-PF-VERO13-18_(CXA1850)

Lamps: 1 x CREE_CXA1850_(CXA1850-30F-T4-N0Y-00001)

_847.836lm@250mA_CCT=3000K_P=8.27W_I=0.25A

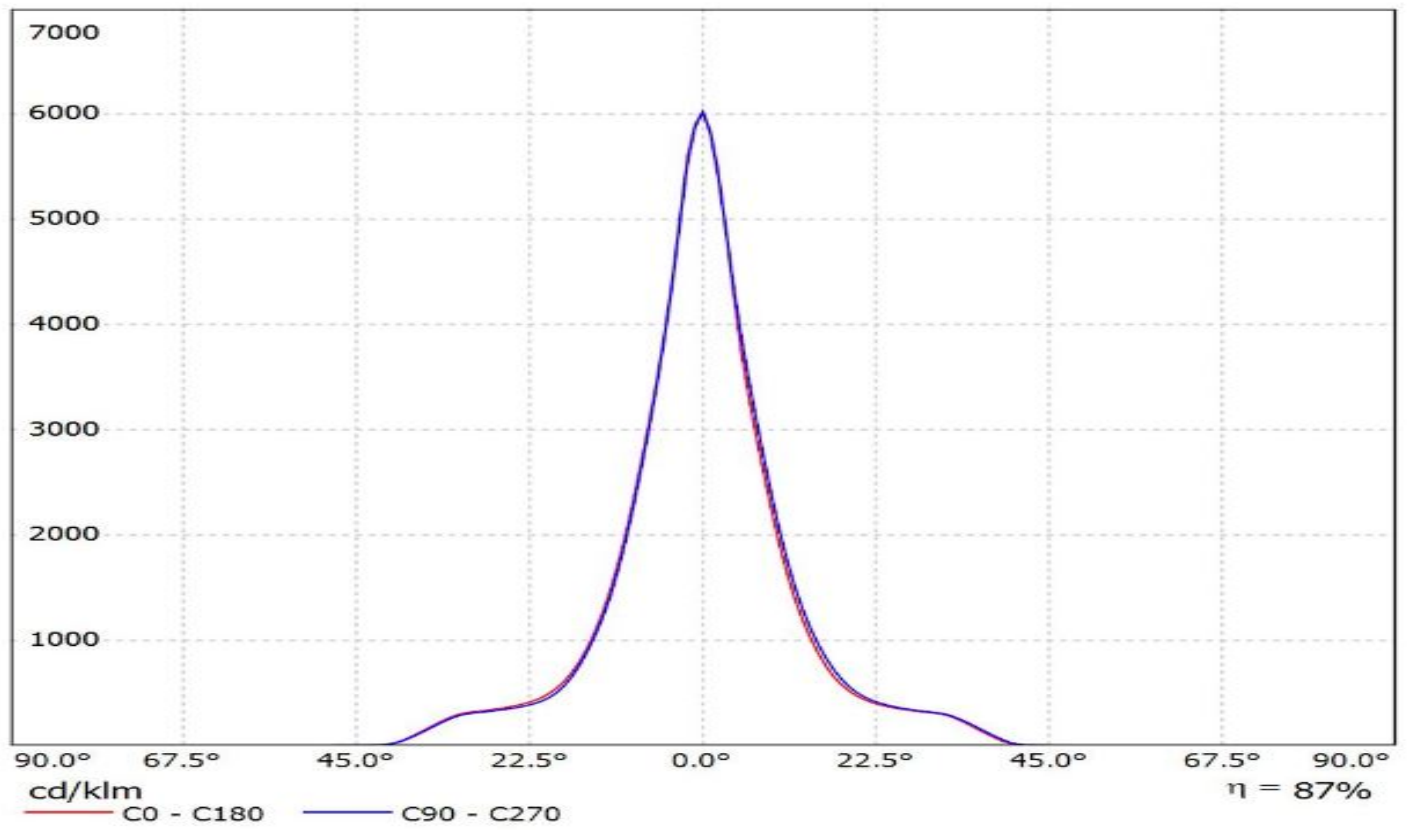

Luminaire: LEDiL Oy FCN13925_BARBARA-S-PF-VERO13/18_(CXA1520)_(441_Typ_L1) CXA1520_(CXA1520-30F-N4-N04-00001)_(441_Typ_L1)_(C13709_PF-SOCKET-VERO13-18)_995.617lm@250mA_P=8.72401W_I=0.2499A
Lamps: 1 x CXA1520_(CXA1520-30F-N4-N04-00001)_(441_Typ_L1)_(C13709_PF-SOCKET-VERO13-18)_995.617lm@250mA_P=8.72401W_I=0.2499A

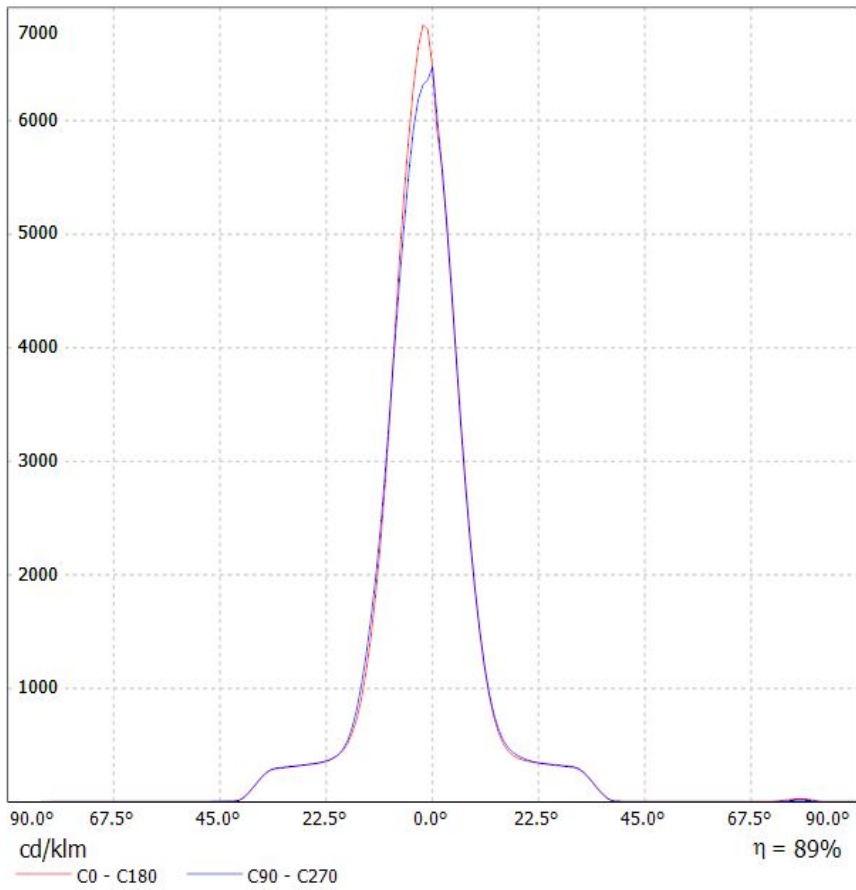

Luminaire: LEDiL Oy FCN13925_BARBARA-S-PF-VERO13/18_(Luxeon_CoB_1203)_ (438_Typ_L1)
Lamps: 1 x Luxeon_CoB_1203_(438_Typ_L1)_C13709_PF-SOCKET-VERO13-18_994.226lm@250mA_P=8.69429W_I=0.2498A

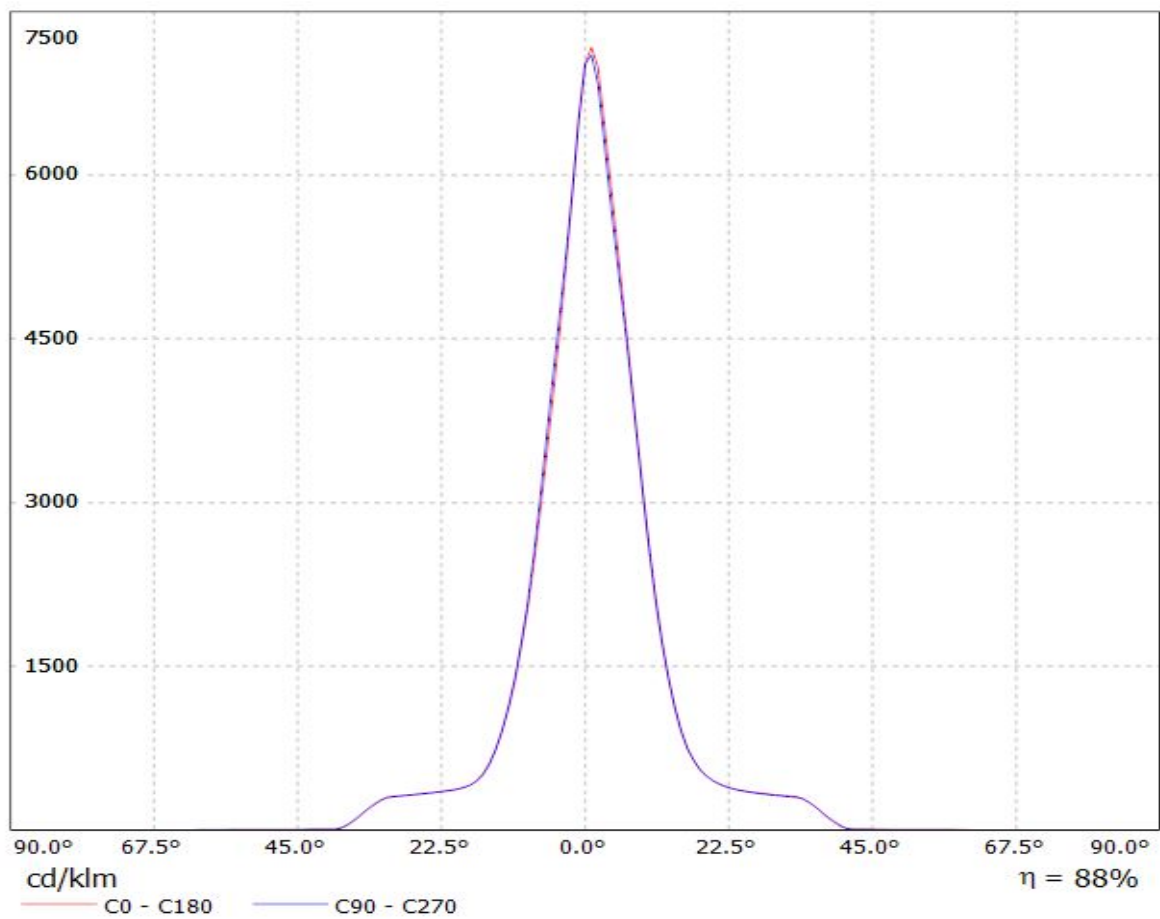

Luminaire: LEDiL Oy FCN13925_BARBARA-S-PF-VERO13/18_(NFCLL036B)

Lamps: 1 x Nichia NFCLL036B (sm403J1300R8000)_542.652lm@100mA_CCT=4000K_P=3.34084W_I=0.100A

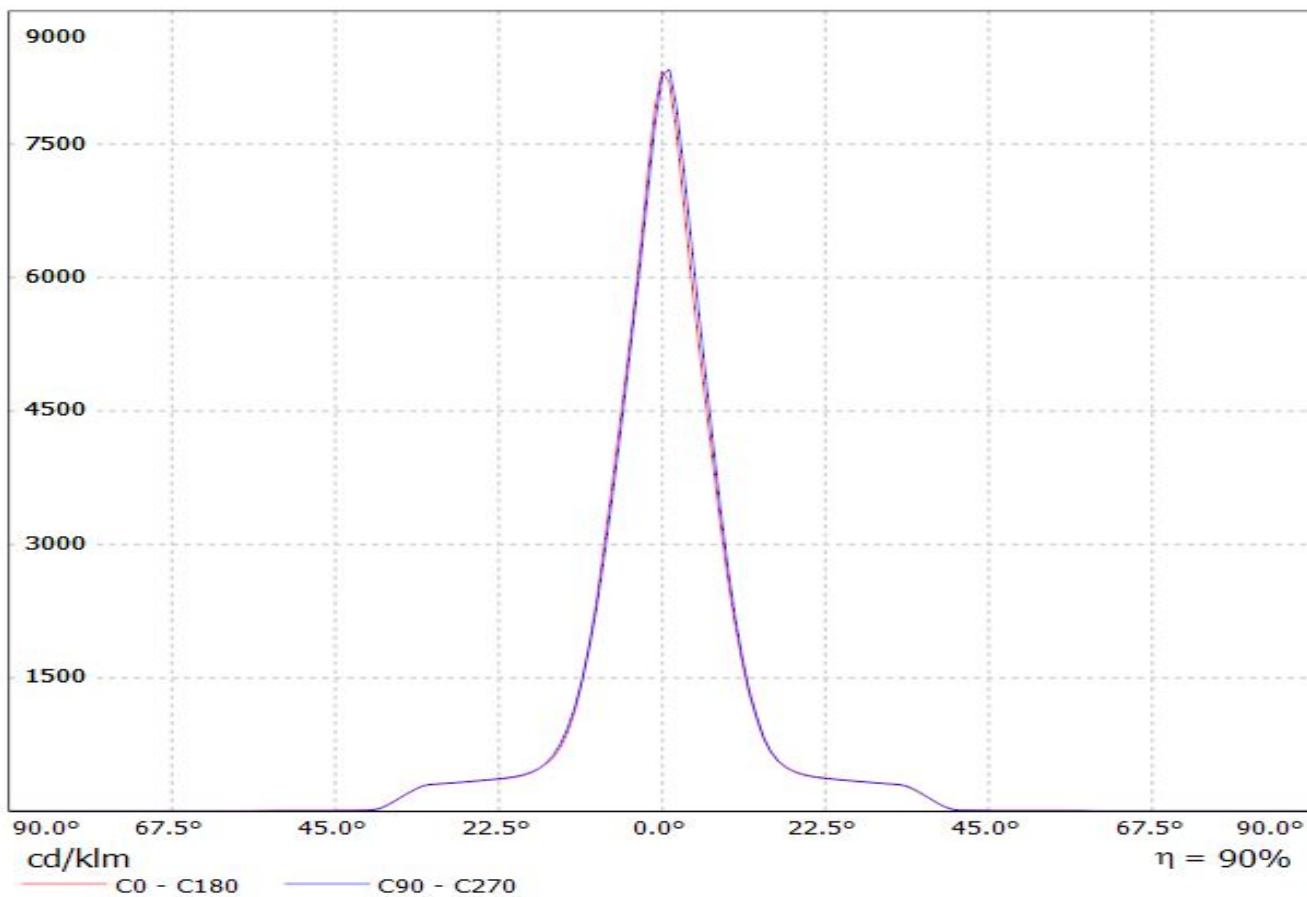

Luminaire: Ledil FCN13925_BARBARA-S-PF-VERO13/18_(NFCLL060B)

Lamps: 1 x Nichia_NFCLL060B_(438_TYP_L1)_1365.88lm@250mA_P=8.375W_I=0.25A

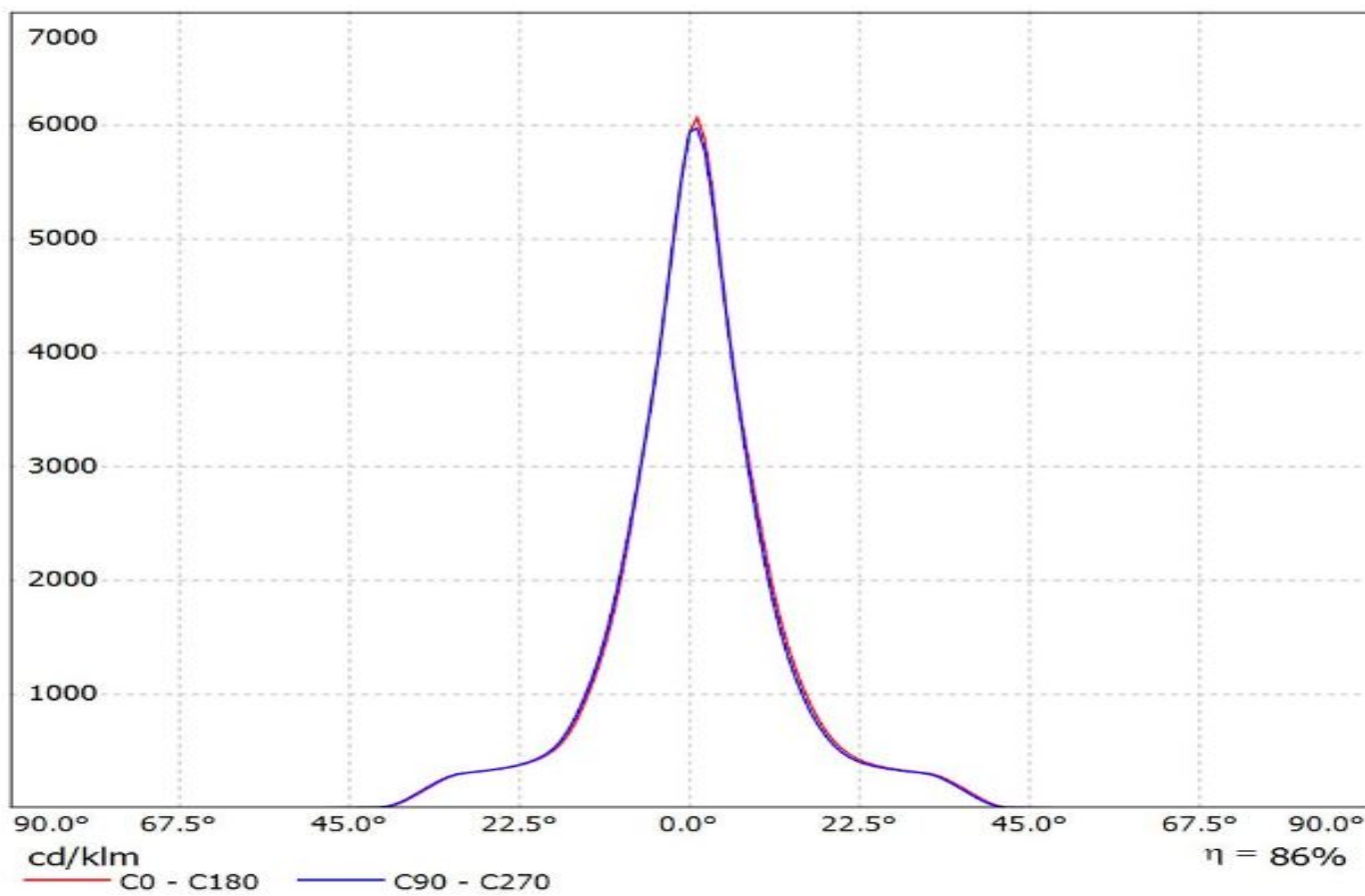

Ledil FCN13925_BARBARA-S-PF-VERO13/18_(NFDxJ130B) / LDC (Linear)

Luminaire: Ledil FCN13925_BARBARA-S-PF-VERO13/18_(NFDxJ130B)
Lamps: 1 x Nichia_NFDxJ130B_(463 Typ L2)_C13709_PF-SOCKET-VERO13-18_1532.05lm@250mA_P=8.27W_I=0.25A

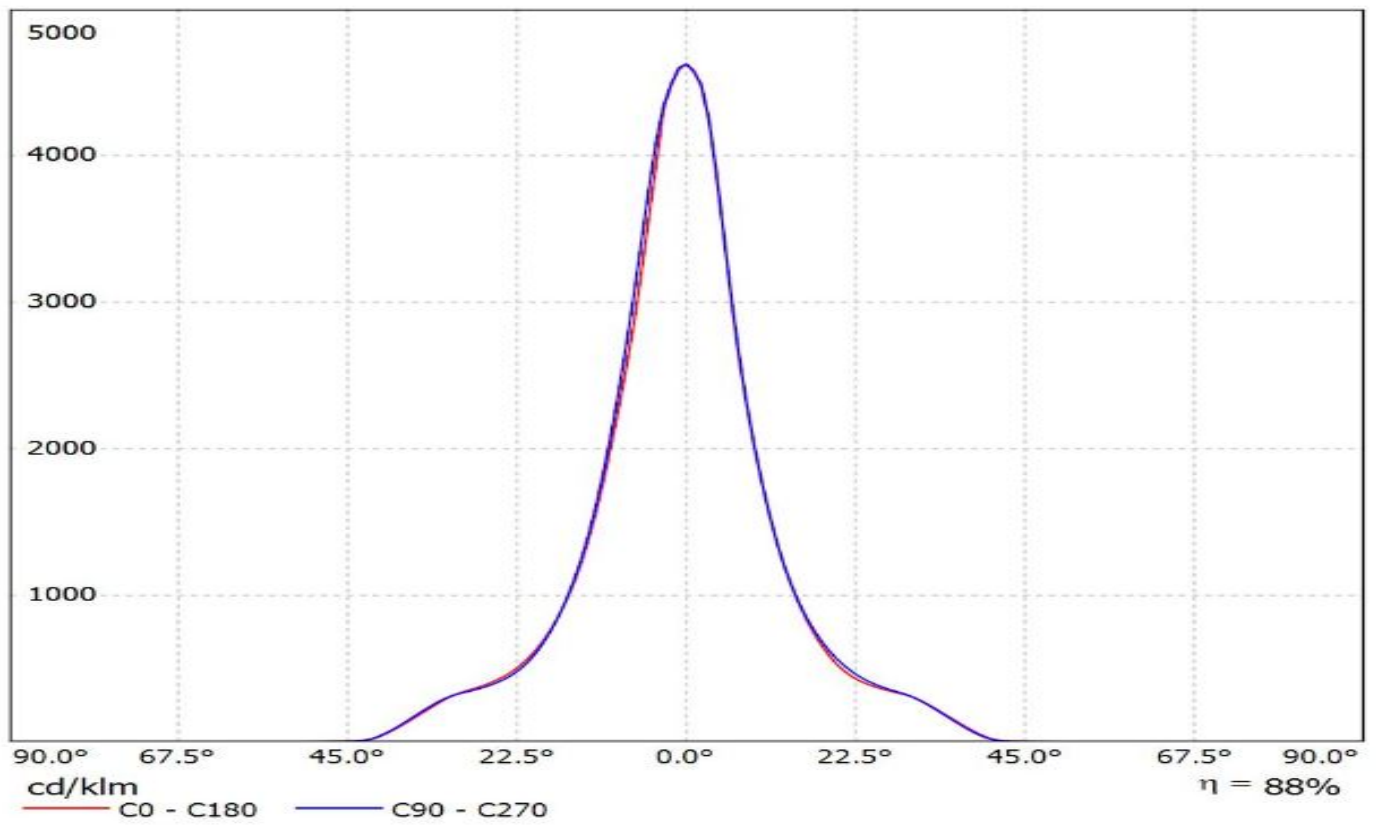

Luminaire: LEDiL Oy FCN13925_BARBARA-S-PF-VERO13/18_(Soleriq_P9)_Bender+Wirth_connector_461
Lamps: 1 x Osram_Soleriq_P9_(GQ_MAFJB1.EM)_875.631lm@250mA_P=6.94894W_I=0.2498A

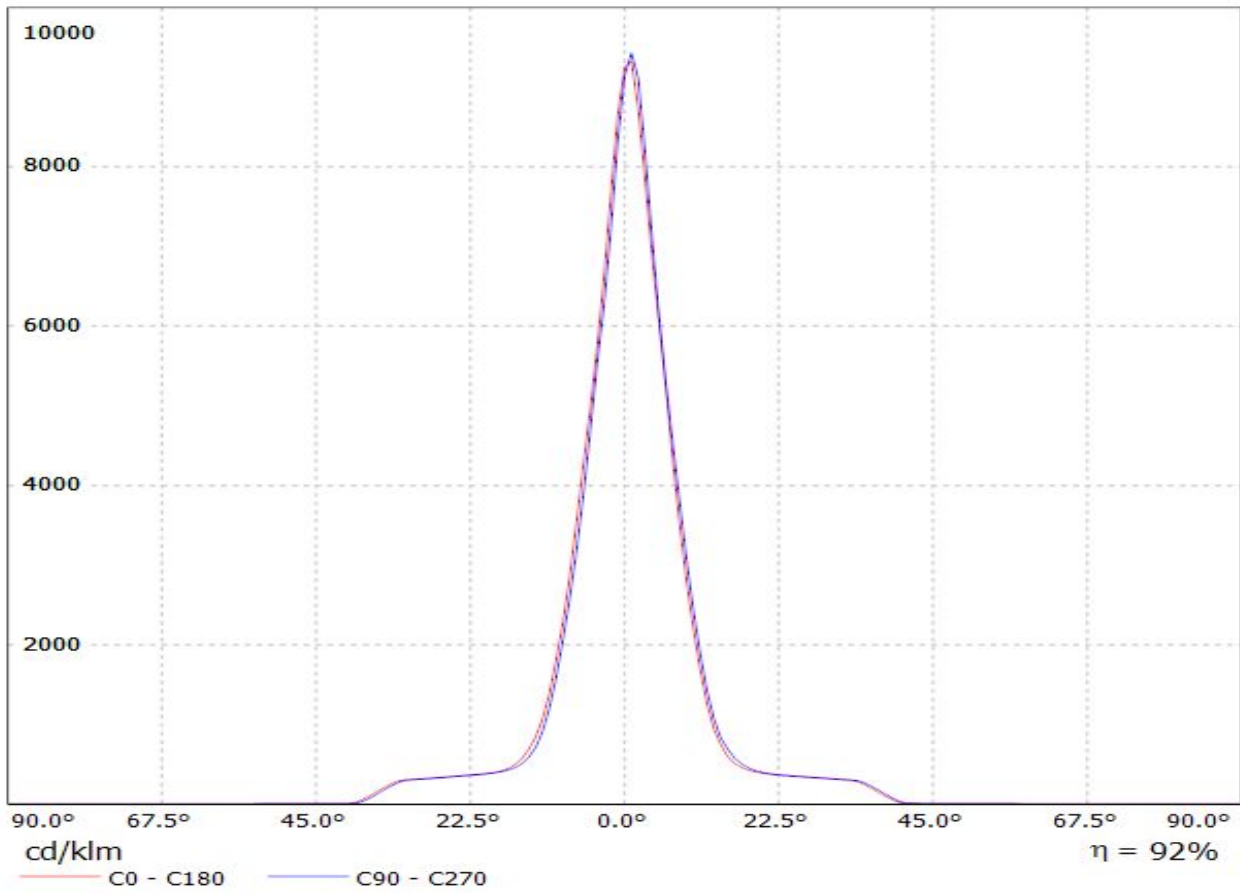

Luminaire: LEDiL Oy FCN13925_BARBARA-S-PF-VERO13/18_(Soleriq P13)
Lamps: 1 x Osram Soleriq P13 (GW MAGMB1.EM)_921.649lm@250mA_CCT=3500K_P=8.8097W_I=0.25A

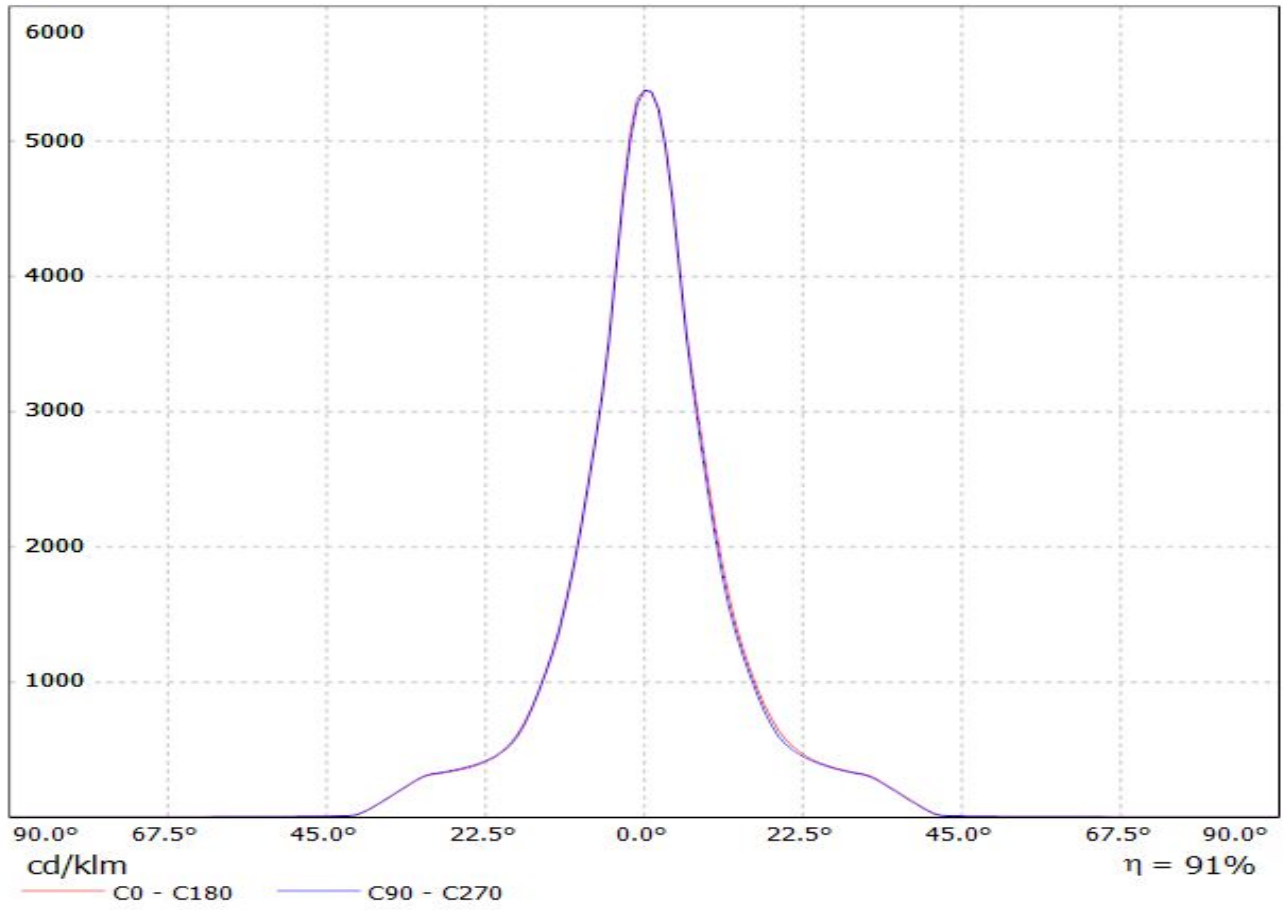

Ledil FCN13925_BARBARA-S-PF-VERO13/18_(P6) / LDC (Linear)

Luminaire: Ledil FCN13925_BARBARA-S-PF-VERO13/18_(P6)

Lamps: 1 x Osram_Soleriq_P6_(GW_MAEGB1.EM)_504.127lm@250mA_P=6.28598W_I=0.25A

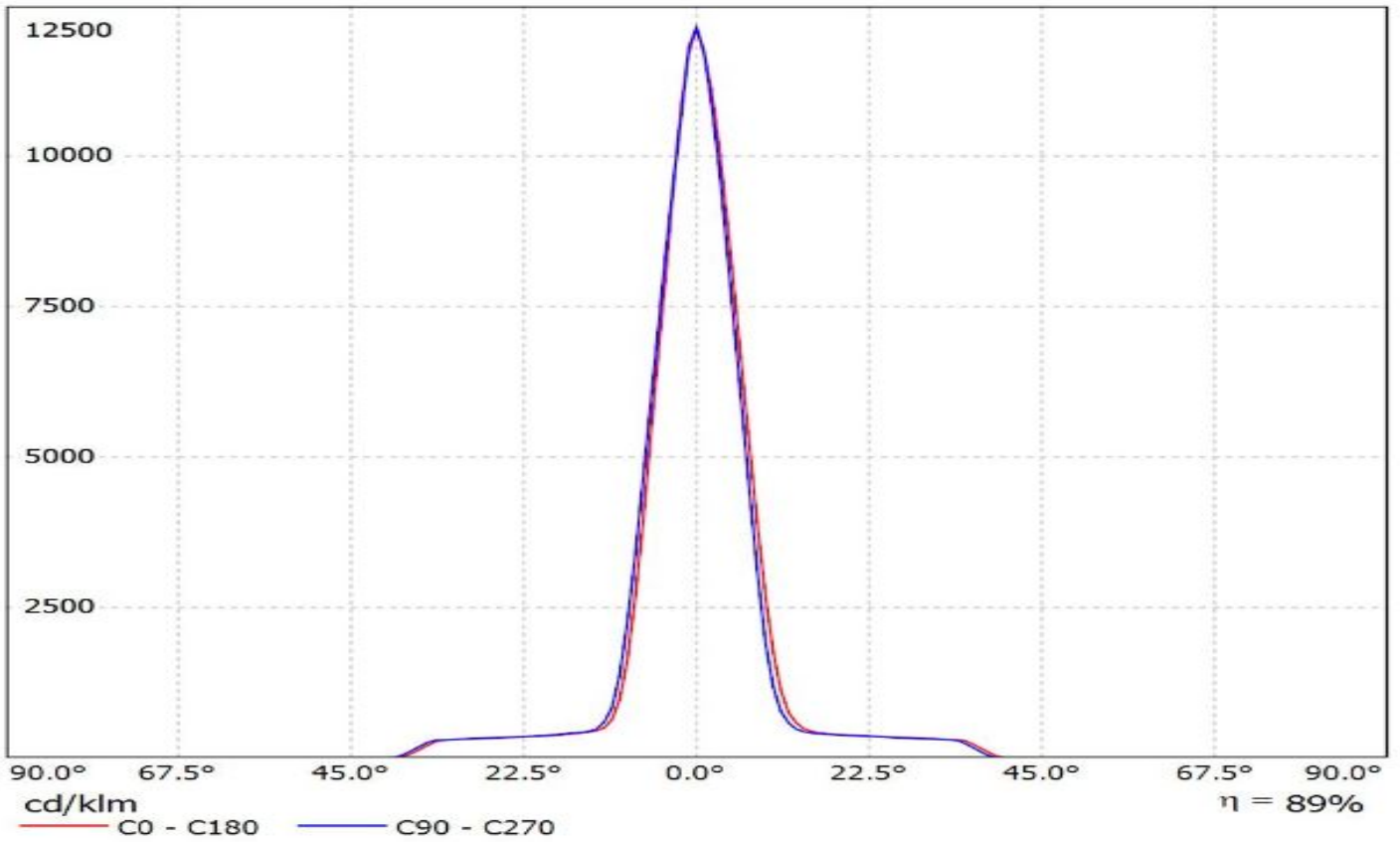

Luminaire: Ledil FCN13925_BARBARA-S-PF-VERO13/18_(Soleriq_S13)
Lamps: 1 x Osram_Soleriq_S13_(GW_KAGHB1.EM)_931.029lm@250mA_P=7.44679W_I=250mA

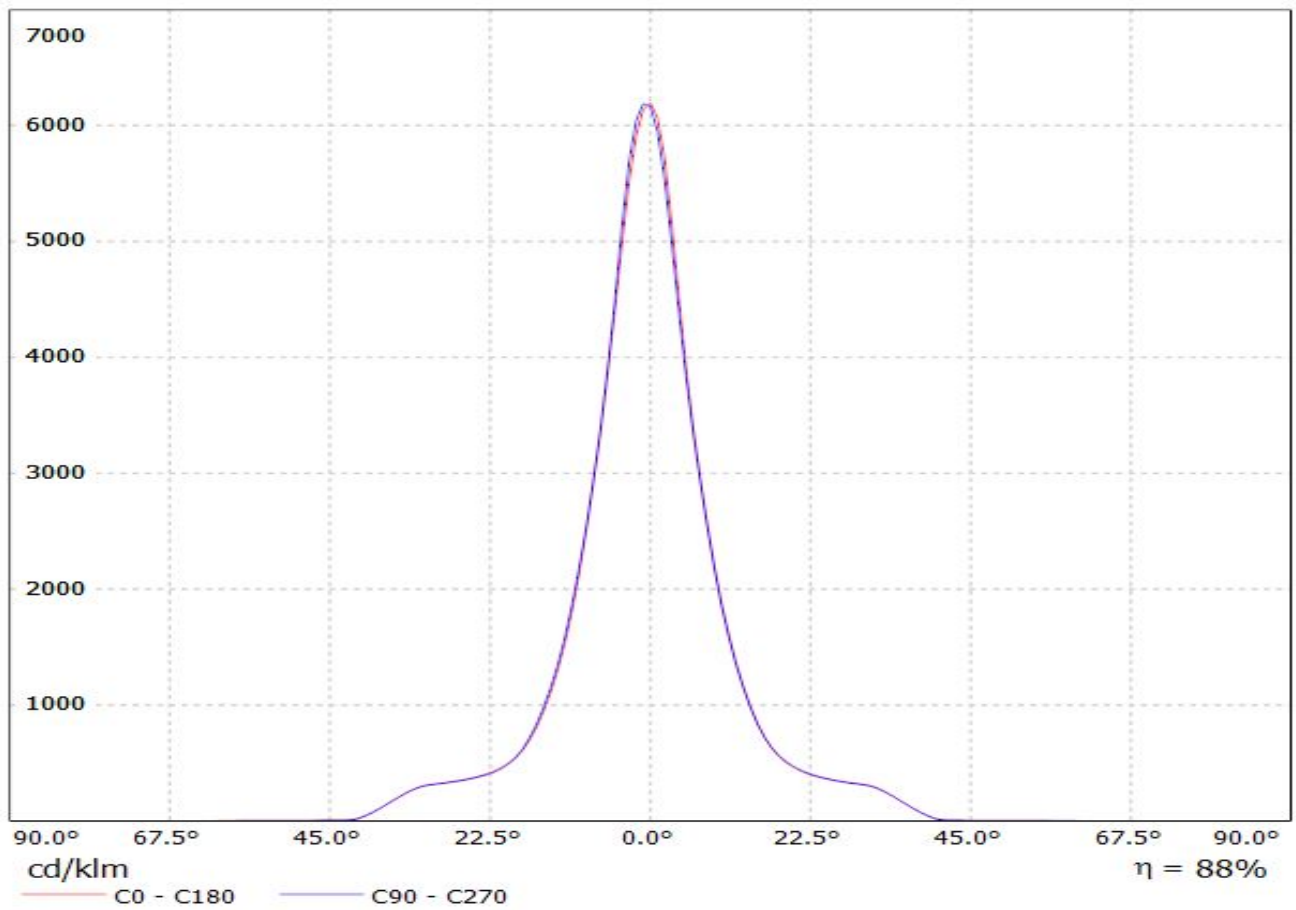

Luminaire: Ledil FCN13925_BARBARA-S-PF-VERO13/18_(LC040B)_(450_Typ_L2)_(C13709)
Lamps: 1 x Samsung_LC040B_(SPHWW1HDNE25010101)_CCT=3000k_(450_Typ_L2)_(C13709_PF-SOCKET-VERO13-18)_1115.79lm@250mA_P=8.075W_I=0.25A

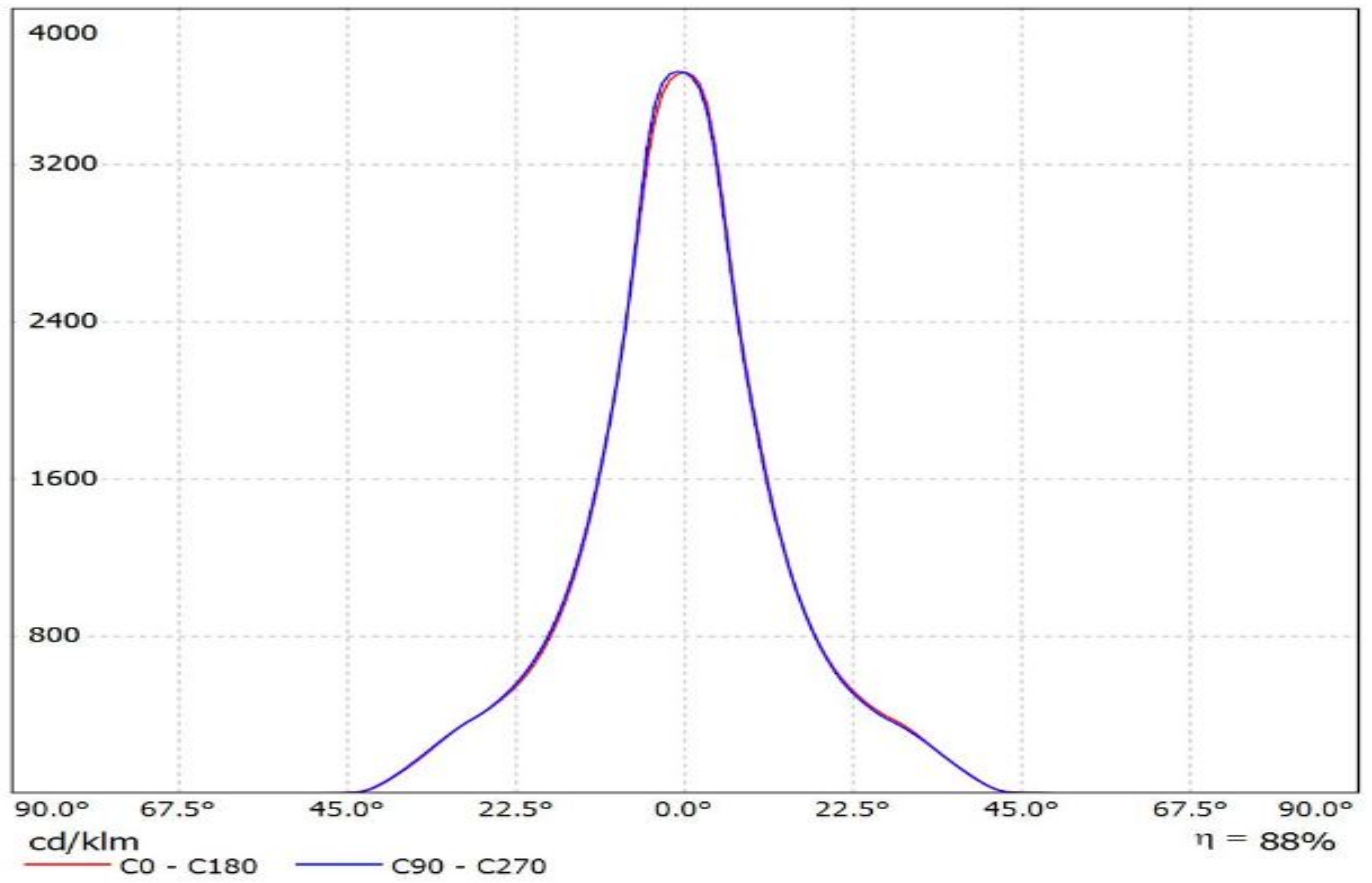

Luminaire: Ledil Oy FCN13925_BARBARA-S-PF-VERO13-18_(LC020C)_(B+W_479_Typ_L1)_SIMULATED
Lamps: 1 x Samsung LC020C + Bender & Wirth 479 Type L1

