



Chipsmall Limited consists of a professional team with an average of over 10 year of expertise in the distribution of electronic components. Based in Hongkong, we have already established firm and mutual-benefit business relationships with customers from,Europe,America and south Asia,supplying obsolete and hard-to-find components to meet their specific needs.

With the principle of “Quality Parts,Customers Priority,Honest Operation,and Considerate Service”,our business mainly focus on the distribution of electronic components. Line cards we deal with include Microchip,ALPS,ROHM,Xilinx,Pulse,ON,Everlight and Freescale. Main products comprise IC,Modules,Potentiometer,IC Socket,Relay,Connector.Our parts cover such applications as commercial,industrial, and automotives areas.

We are looking forward to setting up business relationship with you and hope to provide you with the best service and solution. Let us make a better world for our industry!



Contact us

Tel: +86-755-8981 8866 Fax: +86-755-8427 6832

Email & Skype: info@chipsmall.com Web: www.chipsmall.com

Address: A1208, Overseas Decoration Building, #122 Zhenhua RD., Futian, Shenzhen, China



JENNY-T4

IESNA Type IV light distribution for wider roads and large outdoor areas. Assembly with black frame.

TECHNICAL SPECIFICATIONS:

Dimensions	35 + 50 mm
Height	17 mm
Fastening	screw
Colour	clear
Box size	
Box weight	0 kg
Quantity in Box	1020 pcs
ROHS compliant	yes ⓘ



MATERIAL SPECIFICATIONS:

Component	Type	Material	Colour
JENNY-T4	Lens	Silicone	clear
JENNY-HLD-A-BLK	Accessory	PC	black

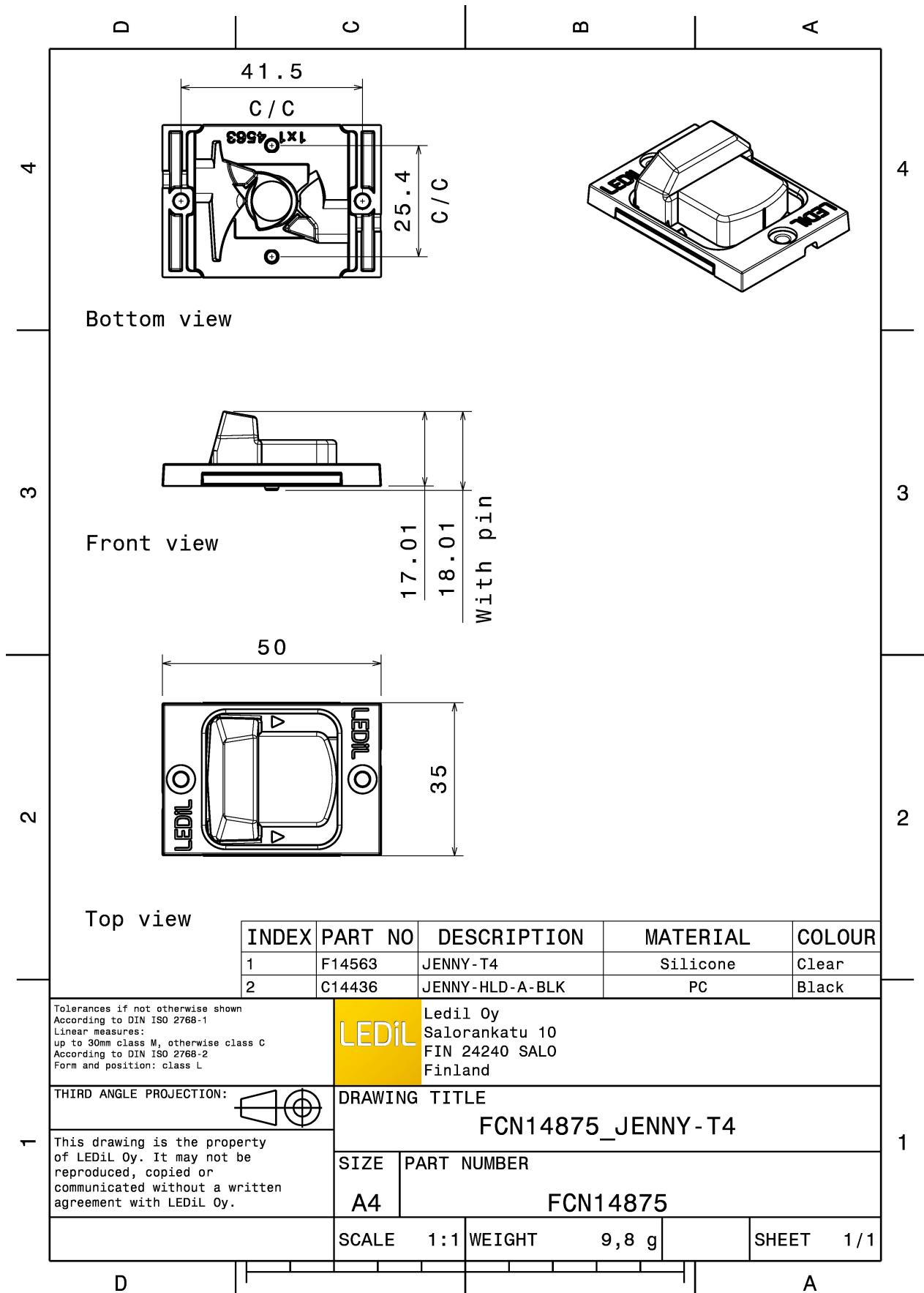

PHOTOMETRIC DATA (MEASURED):



LED V10 Gen6
 FWHM Asymmetric
 Efficiency 93 %
 Peak intensity 0.460 cd/lm
 Required components:

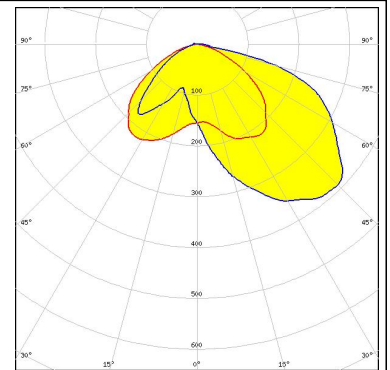

CITIZEN

LED CLL02x/CLU02x (LES10)
 FWHM Asymmetric
 Efficiency 93 %
 Peak intensity 0.460 cd/lm
 Required components:

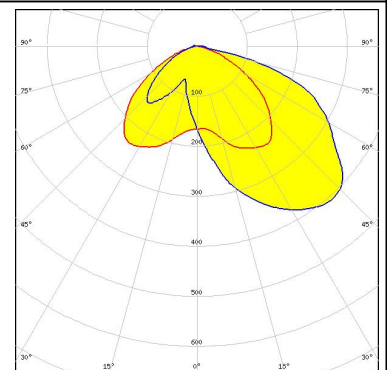

LED CXA/B 15xx
 FWHM Asymmetric
 Efficiency 94 %
 Peak intensity 0.480 cd/lm
 Required components:

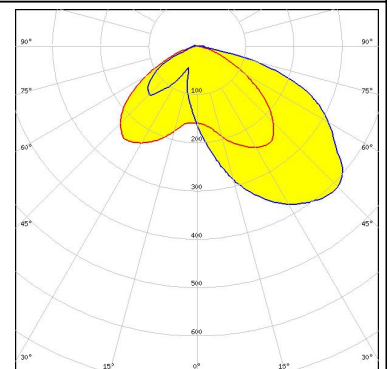

LED MK-R
 FWHM Asymmetric
 Efficiency 93 %
 Peak intensity 0.560 cd/lm
 Required components:

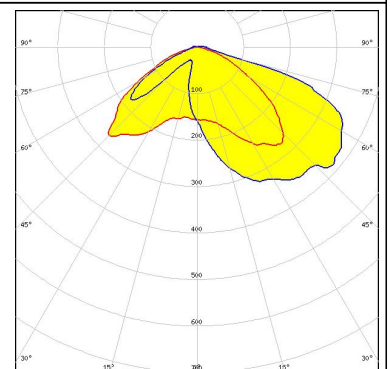

PHOTOMETRIC DATA (MEASURED):

CREE ⇄

LED MX-6
FWHM Asymmetric
Efficiency 92 %
Peak intensity 0.610 cd/lm
Required components:

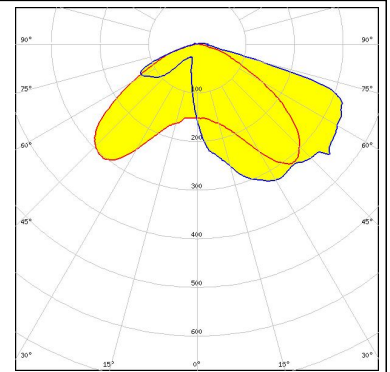

CREE ⇄

LED XHP70
FWHM Asymmetric
Efficiency 91 %
Peak intensity 0.500 cd/lm
Required components:

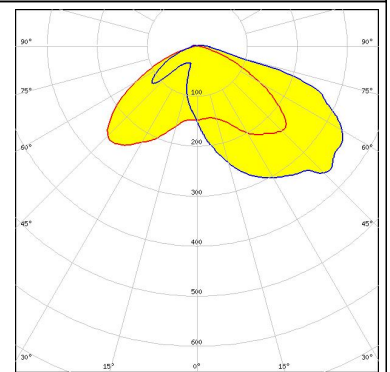

CREE ⇄

LED XM-L EZW
FWHM Asymmetric
Efficiency 93 %
Peak intensity 0.680 cd/lm
Required components:

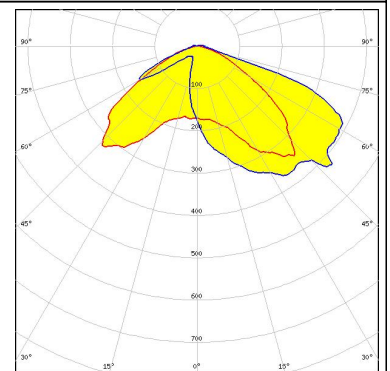

LUMILEDS

LED LUXEON M/MX
FWHM Asymmetric
Efficiency 94 %
Peak intensity 0.660 cd/lm
Required components:

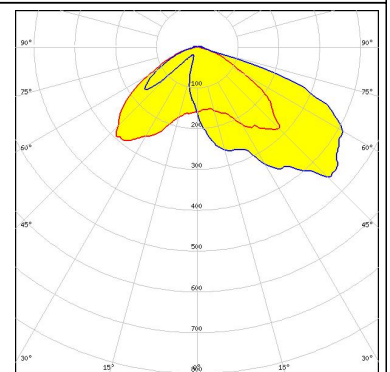

PHOTOMETRIC DATA (MEASURED):



LED CXM-9
FWHM Asymmetric
Efficiency 93 %
Peak intensity 0.460 cd/lm
Required components:

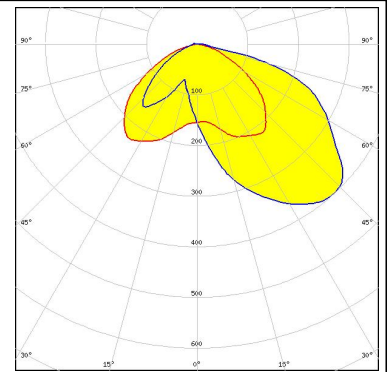

LED NV9W149AM
FWHM Asymmetric
Efficiency 88 %
Peak intensity 0.440 cd/lm
Required components:

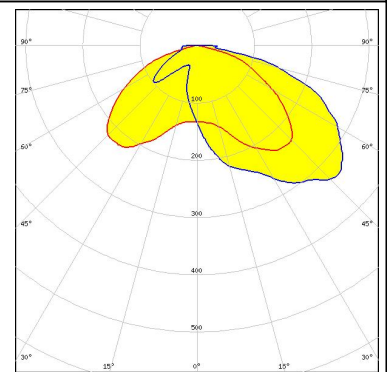



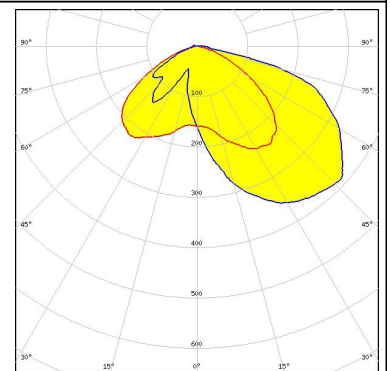



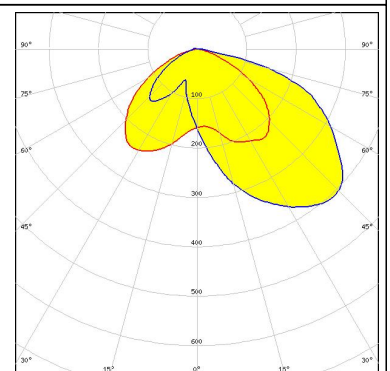

LED Soleriq P9
FWHM Asymmetric
Efficiency 94 %
Peak intensity 0.470 cd/lm
Required components:

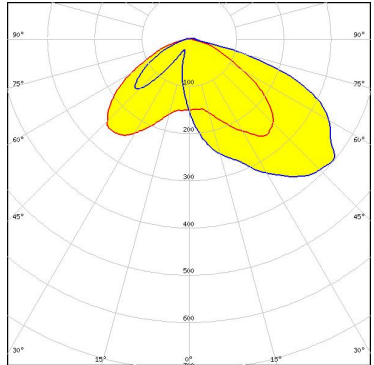

LED COB D Series LES 9.8 mm
FWHM Asymmetric
Efficiency 94 %
Peak intensity 0.470 cd/lm
Required components:

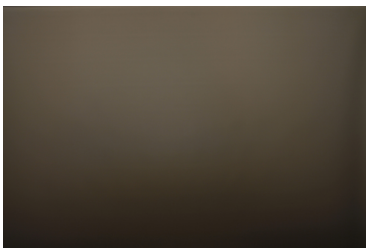
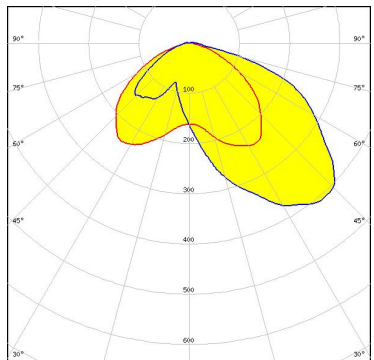

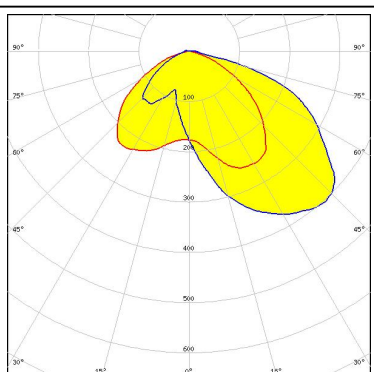
PHOTOMETRIC DATA (MEASURED):

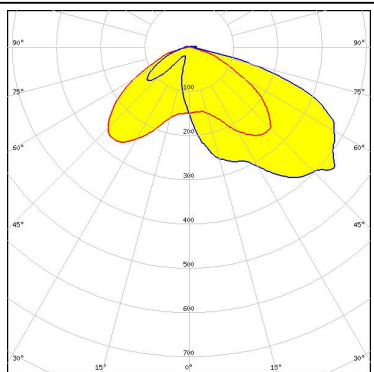
<p> SEOUL SEMICONDUCTOR</p> <p>LED MJT COB LES 6 FWHM Asymmetric Efficiency 92 % Peak intensity 0.540 cd/lm Required components:</p>		
<p> SEOUL SEMICONDUCTOR</p> <p>LED MJT COB LES 9.8 FWHM Asymmetric Efficiency 94 % Peak intensity 0.470 cd/lm Required components:</p>		
<p>TRIDONIC</p> <p>LED SLE G5 LES11 FWHM Asymmetric Efficiency 92 % Peak intensity 0.450 cd/lm Required components:</p>		
<p>TRIDONIC</p> <p>LED SLE G5 LES6 FWHM Asymmetric Efficiency 93 % Peak intensity 0.600 cd/lm Required components:</p>		

PHOTOMETRIC DATA (SIMULATED):

bridgelux

LED V10 Gen7
FWHM Asymmetric
Efficiency 93 %
Peak intensity 0.440 cd/lm
Required components:

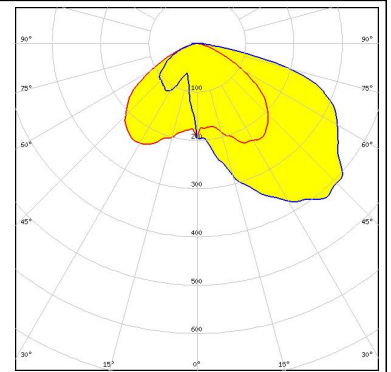

OSRAM
Opto Semiconductors

LED OSCONIQ P 7070
FWHM Asymmetric
Efficiency 92 %
Peak intensity 0.560 cd/lm
Required components:

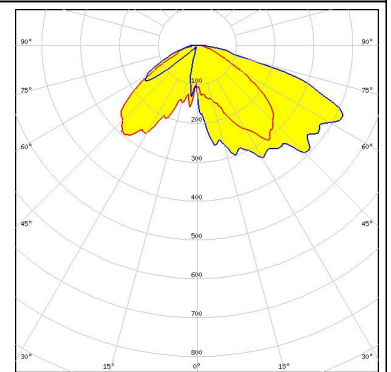

GENERAL INFORMATION:

NOTE: The typical beam angle will be changed by different color, chip size and chip position tolerance. The typical total beam angle is the full angle measured where the luminous intensity is half of the peak value.

Due to use of high power COB's with this product, special attention to proper thermal design is highly recommended. LEDiL has no liability for direct, indirect or consecutive damages arising from the LEDiL products being used outside of the recommended temperature range.

MATERIALS:

As part of our continuous research and improvement processes, and to ensure the best possible quality and availability of our products, LEDiL reserves the right to change material grades without notice.

PRODUCT DATA USER AGREEMENT AND DISCLAIMER:

The measured data in the provided downloadable LEDiL Product Datasheets and Mechanical 2D-Drawings is rounded and provided as reference for planning. LEDiL Oy's optical specifications have been verified by conducting performance testing of the products in accordance with the company's quality system. The reported data are averaged results of multiple measurements with typical variation. LEDiL Oy reserves the right to without prior notification make changes and improvements to its products.

LEDiL Oy assumes neither warranty, nor guarantee nor any other liability of any kind for the contents and correctness of the provided data. The provided data has been generated with highest diligence but the provided data may in reality not represent the complete possible variation range of all intrinsic parameters. Therefore, in certain cases a deviation from the provided data could occur.

LEDiL Oy reserves the right to undertake technical changes of its products without further notification which could lead to changes in the provided data. LEDiL Oy assumes no liability of any kind for the possible deviation from any provided data or any other damage resulting from the usage of the provided data.

The user agrees to this disclaimer and user agreement with the download or usage of the provided files.

LEDiL Oy

Joensuunkatu 13
FI-24240 SALO
Finland

LEDiL Inc.

228 West Page Street
Suite D
Sycamore IL 60178
USA

Local sales and technical support

www.ledil.com/where_to_buy

Shipping locations

Salo, Finland
Hong Kong, China

Distribution Partners

www.ledil.com/where_to_buy