



Chipsmall Limited consists of a professional team with an average of over 10 year of expertise in the distribution of electronic components. Based in Hongkong, we have already established firm and mutual-benefit business relationships with customers from,Europe,America and south Asia,supplying obsolete and hard-to-find components to meet their specific needs.

With the principle of “Quality Parts,Customers Priority,Honest Operation,and Considerate Service”,our business mainly focus on the distribution of electronic components. Line cards we deal with include Microchip,ALPS,ROHM,Xilinx,Pulse,ON,Everlight and Freescale. Main products comprise IC,Modules,Potentiometer,IC Socket,Relay,Connector.Our parts cover such applications as commercial,industrial, and automotives areas.

We are looking forward to setting up business relationship with you and hope to provide you with the best service and solution. Let us make a better world for our industry!



Contact us

Tel: +86-755-8981 8866 Fax: +86-755-8427 6832

Email & Skype: info@chipsmall.com Web: www.chipsmall.com

Address: A1208, Overseas Decoration Building, #122 Zhenhua RD., Futian, Shenzhen, China



Piezoelectronic Products

Ceramic Resonators

Lead

FCR Series

FEATURES

- The FCR series provide a high degree of stability between the quartz oscillator and the LC or RC oscillating circuits. Temperature characteristics: $1 \times 10^{-5}/^{\circ}\text{C}$ (-20 to $+85^{\circ}\text{C}$).
- Highly miniaturized and lightweight, enabling the design of smaller oscillating circuits.
- Stable oscillation can be obtained without the time-consuming adjustment typically required with LC and RC oscillating circuits.
- Ideal for mass production applications because of adjustments are not required and cost is low.

APPLICATIONS

VCRs, automotive electronics, copiers, telephones, facsimiles, calculators with printers, TV remote controls, and toys.

PRODUCT IDENTIFICATION

FCR 4 MC5 A — T
(1) (2) (3) (4) (5) (6)

(1) Series name

(2) Oscillating frequency [fo]

(3) Characteristics and shapes

Symbol	Oscillating frequency	Circuit capacitance	Type	Shapes/Dimensions
M2G	15 to 50MHz	No built-in	FCR-M2G	Fig.1
M5	3.58 to 10MHz	No built-in	FCR-M5	Fig.2
MC5	3.58 to 10MHz	Built-in	FCR-MC5	Fig.3

(4) Oscillating frequency tolerance

A: $\pm 0.3\%$

Non: $\pm 0.5\%$

(5) TDK internal code

The frequency correlation between the IC and measuring circuits, the allowance, and other identifying factors are used, and the number of digits in the control code is different depending on the contents.

However, this control code is omitted from the "standard products".

* Products with no frequency correlation, and an allowance of $\pm 0.5\%$.

(6) Lead shapes and packaging styles

	Straight lead	Taping
T		
Non	Straight lead	Bulk

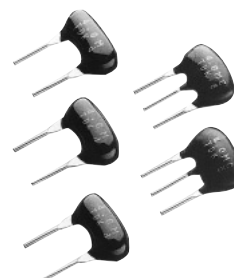

CHARACTERISTICS

Storage temperature range	-40 to $+85^{\circ}\text{C}$
Operating temperature range	-40 to $+85^{\circ}\text{C}$
Frequency tolerance	$\pm 0.5\%$
Temperature stability of frequency	$\pm 0.3\%$ [-40 to $+85^{\circ}\text{C}$]
Time stability	$\pm 0.3\%$ [over 10 years at 25°C]

- Oscillating frequency can be adjusted using a designated circuit.
- The stability of the oscillating frequency is different depending on the IC being used. Please contact TDK for the exact oscillating conditions.

RELIABILITY

Item	Specifications	Test conditions
Insulation resistance ($\text{M}\Omega$)min.	100	Between terminals, and between terminal and body
DC withstand voltage Edc(V)	50[1min]	Between terminals
Terminal tensile strength	No mechanical damage	Terminal's axial direction: 4.9N A direction 90° to the axial direction: 2.45N
Solder heat resistance	Oscillating frequency change: within $\pm 0.25\%$	$260 \pm 5^{\circ}\text{C}$, $10 \pm 0.5\text{s}$ $350 \pm 10^{\circ}\text{C}$, $3 \pm 0.5\text{s}$ $270 \pm 5^{\circ}\text{C}$, $3 \pm 0.5\text{s}$
Vibration	Resonant resistance change: within $\pm 10\Omega$	Frequency: 10 to 55Hz Amplitude: 1.52mm X, Y, Z directions, 2h
Acceleration		100Gal X, X', Y, Y', Z, Z' 6 directions \times 3 times
Solderability	More than 95% of the terminal shall be covered with solder.	$230 \pm 0.5^{\circ}\text{C}$, $3 \pm 0.5\text{s}$ melted solder

Piezoelectronic Products

Ceramic Resonators

Lead

FCR Series

STANDARD TEST CIRCUIT

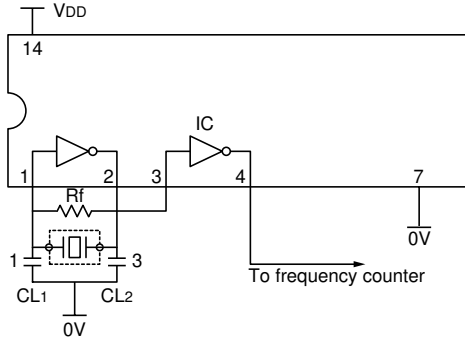

Type	Frequency range	IC name	V _{DD}	R _f	CL ₁	CL ₂
FCR-M5	3.58 to 7.99MHz	TC4069UBP	+5V	1MΩ	30pF	30pF
	8 to 10MHz	TC4069UBP	+5V	1MΩ	20pF	20pF
	15 to 16.9MHz	TC74HCU04	+5V	1MΩ	30pF	30pF
FCR-M2G	17 to 19.9MHz	TC74HCU04	+5V	1MΩ	22pF	22pF
	20 to 29.9MHz	TC74HCU04	+5V	1MΩ	15pF	15pF
	30 to 39.9MHz	TC74HCU04	+5V	1MΩ	10pF	10pF
	40 to 50MHz	TC74HCU04	+5V	1MΩ	5pF	5pF

SHAPES AND DIMENSIONS

EXTERNAL LOAD

CAPACITANCE TYPE

FCR-M2G(15 to 50MHz)

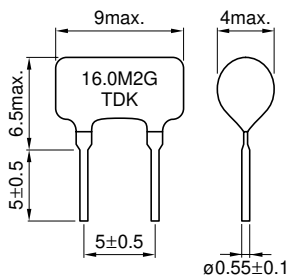

Fig. 1

FCR-M5(3.58 to 10MHz)

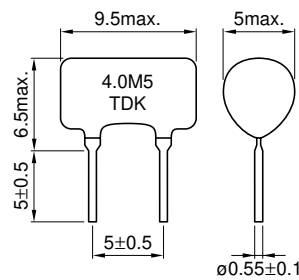

Fig. 2

BUILT-IN LOAD

CAPACITANCE TYPE

FCR-MC5(3.58 to 10MHz)

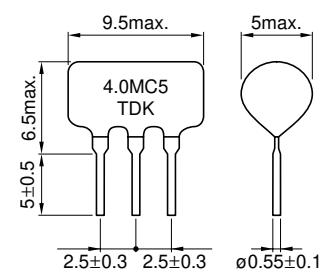
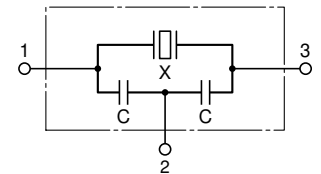

Fig. 3

CIRCUIT DIAGRAM



Dimensions in mm

ELECTRICAL CHARACTERISTICS

Part No.	Fig.	Oscillating frequency	Oscillating frequency tolerance	Load capacitance C ₁ , C ₂	Vibration mode
FCR-M2G Type					
FCR16.0M2G_*1_*2	1	16MHz	±0.3, ±0.5%	15pF	Thickness direction expand oscillation
FCR24.0M2G_		24MHz	±0.3, ±0.5%	10pF	
FCR32.0M2G_		32MHz	±0.3, ±0.5%	5pF	
FCR50.0M2G_		50MHz	±0.3, ±0.5%	5pF	
FCR-M5 Type					
FCR4.0M5_	2	4MHz	±0.3, ±0.5%	30pF	Shear oscillation in thickness direction
FCR4.19M5_		4.19MHz	±0.3, ±0.5%	30pF	
FCR6.0M5_		6MHz	±0.3, ±0.5%	30pF	
FCR8.0M5_		8MHz	±0.3, ±0.5%	20pF	
FCR10.0M5_		10MHz	±0.3, ±0.5%	20pF	
FCR-MC5 Type					
FCR4.0MC5_	3	4MHz	±0.3, ±0.5%	30pF (Built-in capacitance)	Shear oscillation in thickness direction
FCR4.19MC5_		4.19MHz	±0.3, ±0.5%	30pF (Built-in capacitance)	
FCR6.0MC5_		6MHz	±0.3, ±0.5%	30pF (Built-in capacitance)	
FCR8.0MC5_		8MHz	±0.3, ±0.5%	20pF (Built-in capacitance)	
FCR10.0MC5_		10MHz	±0.3, ±0.5%	20pF (Built-in capacitance)	

*1 : Please specify oscillating frequency tolerance

A: ±0.3%, Non: ±0.5%

*2 : Please specify lead shapes and packaging styles

T: Straight lead/Taping

Non: Straight lead/Bulk

Piezoelectronic Products

FCR Series

Ceramic Resonators

Lead

TAPING SPECIFICATIONS

FCR-M2G, -M5 (Fig. 1)

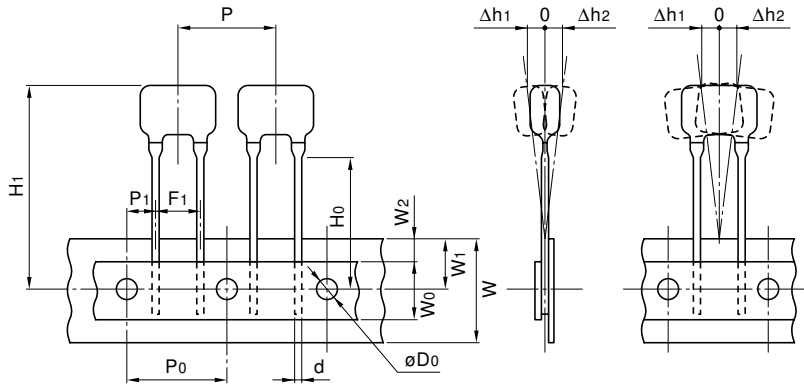

FCR-MC5 (Fig. 2)

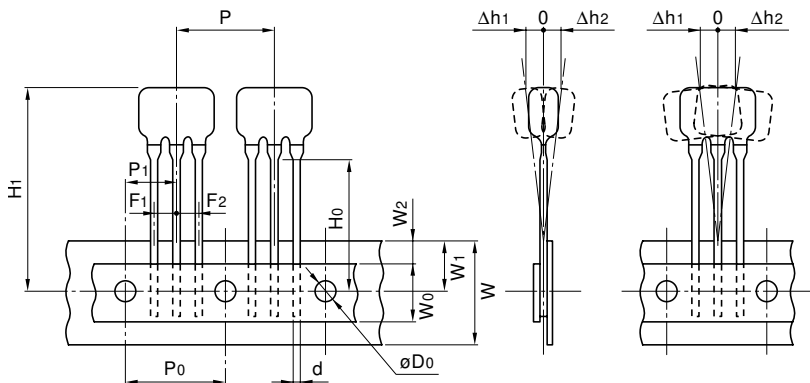

Dimensions in mm		
Type	FCR-M2G, -M5	FCR-MC5
Fig.	1	2
P	12.7±1	12.7±1
P ₀ * ¹	12.7±0.3	12.7±0.3
P ₁	3.85±1.3	3.85±1.3
F ₁ , F ₂ * ²	5±0.3	2.5±0.3
W	18+1,-0.5	18+1,-0.5
W ₀	11.5min.	11.5min.
W ₁	9±0.5	9±0.5
W ₂	5max.	5max.
H ₀ * ³	16±0.5/18+1.5,-0	16±0.5/18+1.5,-0
D ₀	ø4±0.2	ø4±0.2
Δh ₁ , Δh ₂ * ⁴	0±2°	0±2°
d	0.55±0.1	0.55±0.1
H ₁	30max.	30max.

*¹ The cumulative pitch tolerance is ±1mm at 20 pitches.

*² The measurement position is the top of the tape and between the leads.

*³ The measurement position is under the stopper.

16mm: PANAMOUNT

18mm: AVIMOUNT

*⁴ The measurement position is at a product of the top.