



Chipsmall Limited consists of a professional team with an average of over 10 year of expertise in the distribution of electronic components. Based in Hongkong, we have already established firm and mutual-benefit business relationships with customers from,Europe,America and south Asia,supplying obsolete and hard-to-find components to meet their specific needs.

With the principle of “Quality Parts,Customers Priority,Honest Operation,and Considerate Service”,our business mainly focus on the distribution of electronic components. Line cards we deal with include Microchip,ALPS,ROHM,Xilinx,Pulse,ON,Everlight and Freescale. Main products comprise IC,Modules,Potentiometer,IC Socket,Relay,Connector.Our parts cover such applications as commercial,industrial, and automotives areas.

We are looking forward to setting up business relationship with you and hope to provide you with the best service and solution. Let us make a better world for our industry!



Contact us

Tel: +86-755-8981 8866 Fax: +86-755-8427 6832

Email & Skype: info@chipsmall.com Web: www.chipsmall.com

Address: A1208, Overseas Decoration Building, #122 Zhenhua RD., Futian, Shenzhen, China



PrimePACK™2 Modul mit Trench/Feldstopp IGBT4, größerer Emitter Controlled 4 Diode
PrimePACK™2 module with Trench/Fieldstop IGBT4, enlarged Emitter Controlled 4 diode

Vorläufige Daten / Preliminary Data

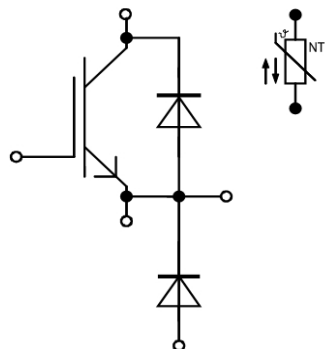

$V_{CES} = 1200V$
 $I_{C\ nom} = 900A / I_{CRM} = 1800A$

Typische Anwendungen

- Chopper-Anwendungen

Typical Applications

- Chopper Applications

Elektrische Eigenschaften

- Erweiterte Sperrschichttemperatur $T_{vj\ op}$
- Große DC-Festigkeit
- Hohe Kurzschlussrobustheit, selbstlimitierender Kurzschlussstrom
- V_{CESat} mit positivem Temperaturkoeffizienten
- Niedriges V_{CESat}

Electrical Features

- Extended Operation Temperature $T_{vj\ op}$
- High DC Stability
- High Short Circuit Capability, Self Limiting Short Circuit Current
- V_{CESat} with positive Temperature Coefficient
- Low V_{CESat}

Mechanische Eigenschaften

- 4 kV AC 1min Isolationsfestigkeit
- Gehäuse mit CTI > 400
- Große Luft- und Kriechstrecken
- Hohe Last- und thermische Wechselfestigkeit
- Hohe Leistungsdichte
- Substrat für kleinen thermischen Widerstand

Mechanical Features

- 4 kV AC 1min Insulation
- Package with CTI > 400
- High Creepage and Clearance Distances
- High Power and Thermal Cycling Capability
- High Power Density
- Substrate for Low Thermal Resistance

Module Label Code

Barcode Code 128



DMX - Code



Content of the Code

	Digit
Module Serial Number	1 - 5
Module Material Number	6 - 11
Production Order Number	12 - 19
Datecode (Production Year)	20 - 21
Datecode (Production Week)	22 - 23

prepared by: AC	date of publication: 2013-11-05	
approved by: MS	revision: 2.2	UL approved (E83335)



**Vorläufige Daten
Preliminary Data**

IGBT-Chopper / IGBT-Chopper

Höchstzulässige Werte / Maximum Rated Values

Kollektor-Emitter-Sperrspannung Collector-emitter voltage	$T_{vj} = 25^{\circ}\text{C}$	V_{CES}	1200	V
Kollektor-Dauergleichstrom Continuous DC collector current	$T_C = 100^{\circ}\text{C}, T_{vj\max} = 175^{\circ}\text{C}$	$I_{C\text{nom}}$	900	A
Periodischer Kollektor-Spitzenstrom Repetitive peak collector current	$t_P = 1\text{ ms}$	I_{CRM}	1800	A
Gesamt-Verlustleistung Total power dissipation	$T_C = 25^{\circ}\text{C}, T_{vj\max} = 175^{\circ}\text{C}$	P_{tot}	5,10	kW
Gate-Emitter-Spitzenspannung Gate-emitter peak voltage		V_{GES}	+/-20	V

Charakteristische Werte / Characteristic Values

			min.	typ.	max.	
Kollektor-Emitter-Sättigungsspannung Collector-emitter saturation voltage	$I_C = 900\text{ A}, V_{GE} = 15\text{ V}$ $I_C = 900\text{ A}, V_{GE} = 15\text{ V}$ $I_C = 900\text{ A}, V_{GE} = 15\text{ V}$	$T_{vj} = 25^{\circ}\text{C}$ $T_{vj} = 125^{\circ}\text{C}$ $T_{vj} = 150^{\circ}\text{C}$	$V_{CE\text{sat}}$	1,70 2,00 2,10	2,05	V V V
Gate-Schwellenspannung Gate threshold voltage	$I_C = 33,0\text{ mA}, V_{CE} = V_{GE}, T_{vj} = 25^{\circ}\text{C}$		V_{GEth}	5,0	5,8	6,5 V
Gateladung Gate charge	$V_{GE} = -15\text{ V} \dots +15\text{ V}$		Q_G	6,40		μC
Interner Gatewiderstand Internal gate resistor	$T_{vj} = 25^{\circ}\text{C}$		R_{Gint}	1,2		Ω
Eingangskapazität Input capacitance	$f = 1\text{ MHz}, T_{vj} = 25^{\circ}\text{C}, V_{CE} = 25\text{ V}, V_{GE} = 0\text{ V}$		C_{ies}	54,0		nF
Rückwirkungskapazität Reverse transfer capacitance	$f = 1\text{ MHz}, T_{vj} = 25^{\circ}\text{C}, V_{CE} = 25\text{ V}, V_{GE} = 0\text{ V}$		C_{res}	2,80		nF
Kollektor-Emitter-Reststrom Collector-emitter cut-off current	$V_{CE} = 1200\text{ V}, V_{GE} = 0\text{ V}, T_{vj} = 25^{\circ}\text{C}$		I_{CES}		5,0	mA
Gate-Emitter-Reststrom Gate-emitter leakage current	$V_{CE} = 0\text{ V}, V_{GE} = 20\text{ V}, T_{vj} = 25^{\circ}\text{C}$		I_{GES}		400	nA
Einschaltverzögerungszeit, induktive Last Turn-on delay time, inductive load	$I_C = 900\text{ A}, V_{CE} = 600\text{ V}$ $V_{GE} = \pm 15\text{ V}$ $R_{Gon} = 1,6\ \Omega$	$T_{vj} = 25^{\circ}\text{C}$ $T_{vj} = 125^{\circ}\text{C}$ $T_{vj} = 150^{\circ}\text{C}$	t_{don}	0,20 0,22 0,22		μs μs μs
Anstiegszeit, induktive Last Rise time, inductive load	$I_C = 900\text{ A}, V_{CE} = 600\text{ V}$ $V_{GE} = \pm 15\text{ V}$ $R_{Gon} = 1,6\ \Omega$	$T_{vj} = 25^{\circ}\text{C}$ $T_{vj} = 125^{\circ}\text{C}$ $T_{vj} = 150^{\circ}\text{C}$	t_r	0,14 0,15 0,15		μs μs μs
Abschaltverzögerungszeit, induktive Last Turn-off delay time, inductive load	$I_C = 900\text{ A}, V_{CE} = 600\text{ V}$ $V_{GE} = \pm 15\text{ V}$ $R_{Goff} = 1,6\ \Omega$	$T_{vj} = 25^{\circ}\text{C}$ $T_{vj} = 125^{\circ}\text{C}$ $T_{vj} = 150^{\circ}\text{C}$	t_{doff}	0,70 0,80 0,85		μs μs μs
Fallzeit, induktive Last Fall time, inductive load	$I_C = 900\text{ A}, V_{CE} = 600\text{ V}$ $V_{GE} = \pm 15\text{ V}$ $R_{Goff} = 1,6\ \Omega$	$T_{vj} = 25^{\circ}\text{C}$ $T_{vj} = 125^{\circ}\text{C}$ $T_{vj} = 150^{\circ}\text{C}$	t_f	0,20 0,40 0,45		μs μs μs
Einschaltverlustenergie pro Puls Turn-on energy loss per pulse	$I_C = 900\text{ A}, V_{CE} = 600\text{ V}, L_S = 45\text{ nH}$ $V_{GE} = \pm 15\text{ V}, di/dt = 4800\text{ A}/\mu\text{s} (T_{vj} = 150^{\circ}\text{C})$ $R_{Gon} = 1,6\ \Omega$	$T_{vj} = 25^{\circ}\text{C}$ $T_{vj} = 125^{\circ}\text{C}$ $T_{vj} = 150^{\circ}\text{C}$	E_{on}	50,0 70,0 80,0		mJ mJ mJ
Abschaltverlustenergie pro Puls Turn-off energy loss per pulse	$I_C = 900\text{ A}, V_{CE} = 600\text{ V}, L_S = 45\text{ nH}$ $V_{GE} = \pm 15\text{ V}, du/dt = 2700\text{ V}/\mu\text{s} (T_{vj} = 150^{\circ}\text{C})$ $R_{Goff} = 1,6\ \Omega$	$T_{vj} = 25^{\circ}\text{C}$ $T_{vj} = 125^{\circ}\text{C}$ $T_{vj} = 150^{\circ}\text{C}$	E_{off}	150 200 205		mJ mJ mJ
Kurzschlußverhalten SC data	$V_{GE} \leq 15\text{ V}, V_{CC} = 800\text{ V}$ $V_{CEmax} = V_{CES} - L_{SCE} \cdot di/dt$ $t_P \leq 10\ \mu\text{s}, T_{vj} = 150^{\circ}\text{C}$		I_{SC}	3600		A
Wärmewiderstand, Chip bis Gehäuse Thermal resistance, junction to case	pro IGBT / per IGBT		R_{thJC}		29,5	K/kW
Wärmewiderstand, Gehäuse bis Kühlkörper Thermal resistance, case to heatsink	pro IGBT / per IGBT $\lambda_{\text{Paste}} = 1\text{ W}/(\text{m}\cdot\text{K})$ / $\lambda_{\text{grease}} = 1\text{ W}/(\text{m}\cdot\text{K})$		R_{thCH}	16,0		K/kW
Temperatur im Schaltbetrieb Temperature under switching conditions			$T_{vj\text{op}}$	-40	150	$^{\circ}\text{C}$

prepared by: AC	date of publication: 2013-11-05
approved by: MS	revision: 2.2



**Vorläufige Daten
Preliminary Data**

**Diode-Chopper / Diode-Chopper
Höchstzulässige Werte / Maximum Rated Values**

Periodische Spitzensperrspannung Repetitive peak reverse voltage	$T_{vj} = 25^{\circ}\text{C}$	V_{RRM}	1200	V
Dauergleichstrom Continuous DC forward current		I_F	900	A
Periodischer Spitzenstrom Repetitive peak forward current	$t_p = 1 \text{ ms}$	I_{FRM}	1800	A
Grenzlastintegral I^2t - value	$V_R = 0 \text{ V}, t_p = 10 \text{ ms}, T_{vj} = 125^{\circ}\text{C}$ $V_R = 0 \text{ V}, t_p = 10 \text{ ms}, T_{vj} = 150^{\circ}\text{C}$	I^2t	150	kA^2s
			145	kA^2s

Charakteristische Werte / Characteristic Values

			min.	typ.	max.	
Durchlassspannung Forward voltage	$I_F = 900 \text{ A}, V_{GE} = 0 \text{ V}$	$T_{vj} = 25^{\circ}\text{C}$	V_F	1,65	2,15	V
	$I_F = 900 \text{ A}, V_{GE} = 0 \text{ V}$	$T_{vj} = 125^{\circ}\text{C}$		1,55		V
	$I_F = 900 \text{ A}, V_{GE} = 0 \text{ V}$	$T_{vj} = 150^{\circ}\text{C}$		1,50		V
Rückstromspitze Peak reverse recovery current	$I_F = 900 \text{ A}, -di_F/dt = 4800 \text{ A}/\mu\text{s} (T_{vj}=150^{\circ}\text{C})$ $V_R = 600 \text{ V}$	$T_{vj} = 25^{\circ}\text{C}$	I_{RM}	560		A
		$T_{vj} = 125^{\circ}\text{C}$		770		A
		$T_{vj} = 150^{\circ}\text{C}$		820		A
Sperrverzögerungsladung Recovered charge	$I_F = 900 \text{ A}, -di_F/dt = 4800 \text{ A}/\mu\text{s} (T_{vj}=150^{\circ}\text{C})$ $V_R = 600 \text{ V}$	$T_{vj} = 25^{\circ}\text{C}$	Q_r	110		μC
		$T_{vj} = 125^{\circ}\text{C}$		200		μC
		$T_{vj} = 150^{\circ}\text{C}$		225		μC
Abschaltenergie pro Puls Reverse recovery energy	$I_F = 900 \text{ A}, -di_F/dt = 4800 \text{ A}/\mu\text{s} (T_{vj}=150^{\circ}\text{C})$ $V_R = 600 \text{ V}$	$T_{vj} = 25^{\circ}\text{C}$	E_{rec}	50,0		mJ
		$T_{vj} = 125^{\circ}\text{C}$		90,0		mJ
		$T_{vj} = 150^{\circ}\text{C}$		105		mJ
Wärmewiderstand, Chip bis Gehäuse Thermal resistance, junction to case	pro Diode / per diode	R_{thJC}			37,0	K/kW
Wärmewiderstand, Gehäuse bis Kühlkörper Thermal resistance, case to heatsink	pro Diode / per diode $\lambda_{Paste} = 1 \text{ W}/(\text{m}\cdot\text{K}) / \lambda_{grease} = 1 \text{ W}/(\text{m}\cdot\text{K})$	R_{thCH}		20,0		K/kW
Temperatur im Schaltbetrieb Temperature under switching conditions		$T_{vj op}$	-40		150	$^{\circ}\text{C}$

**Diode, Revers / Diode, Reverse
Höchstzulässige Werte / Maximum Rated Values**

Periodische Spitzensperrspannung Repetitive peak reverse voltage	$T_{vj} = 25^{\circ}\text{C}$	V_{RRM}	1200	V
Dauergleichstrom Continuous DC forward current		I_F	120	A
Periodischer Spitzenstrom Repetitive peak forward current	$t_p = 1 \text{ ms}$	I_{FRM}	240	A
Grenzlastintegral I^2t - value	$V_R = 0 \text{ V}, t_p = 10 \text{ ms}, T_{vj} = 125^{\circ}\text{C}$	I^2t	0,17	kA^2s

Charakteristische Werte / Characteristic Values

			min.	typ.	max.	
Durchlassspannung Forward voltage	$I_F = 120 \text{ A}, V_{GE} = 0 \text{ V}$ $I_F = 120 \text{ A}, V_{GE} = 0 \text{ V}$	$T_{vj} = 25^{\circ}\text{C}$	V_F	1,65	2,15	V
		$T_{vj} = 125^{\circ}\text{C}$		1,65		V
Wärmewiderstand, Chip bis Gehäuse Thermal resistance, junction to case	pro Diode / per diode	R_{thJC}			340	K/kW
Wärmewiderstand, Gehäuse bis Kühlkörper Thermal resistance, case to heatsink	pro Diode / per diode $\lambda_{Paste} = 1 \text{ W}/(\text{m}\cdot\text{K}) / \lambda_{grease} = 1 \text{ W}/(\text{m}\cdot\text{K})$	R_{thCH}		170		K/kW
Temperatur im Schaltbetrieb Temperature under switching conditions		$T_{vj op}$	-40		150	$^{\circ}\text{C}$

prepared by: AC	date of publication: 2013-11-05
approved by: MS	revision: 2.2

**Vorläufige Daten
Preliminary Data**

NTC-Widerstand / NTC-Thermistor

Charakteristische Werte / Characteristic Values

			min.	typ.	max.	
Nennwiderstand Rated resistance	$T_C = 25^\circ\text{C}$	R_{25}		5,00		k Ω
Abweichung von R100 Deviation of R100	$T_C = 100^\circ\text{C}, R_{100} = 493 \Omega$	$\Delta R/R$	-5		5	%
Verlustleistung Power dissipation	$T_C = 25^\circ\text{C}$	P_{25}			20,0	mW
B-Wert B-value	$R_2 = R_{25} \exp [B_{25/50}(1/T_2 - 1/(298,15 \text{ K}))]$	$B_{25/50}$		3375		K
B-Wert B-value	$R_2 = R_{25} \exp [B_{25/80}(1/T_2 - 1/(298,15 \text{ K}))]$	$B_{25/80}$		3411		K
B-Wert B-value	$R_2 = R_{25} \exp [B_{25/100}(1/T_2 - 1/(298,15 \text{ K}))]$	$B_{25/100}$		3433		K

Angaben gemäß gültiger Application Note.
Specification according to the valid application note.

Modul / Module

Isolations-Prüfspannung Isolation test voltage	RMS, f = 50 Hz, t = 1 min.	V_{ISOL}		4,0		kV
Material Modulgrundplatte Material of module baseplate				Cu		
Innere Isolation Internal insulation	Basisisolation (Schutzklasse 1, EN61140) basic insulation (class 1, IEC 61140)			Al_2O_3		
Kriechstrecke Creepage distance	Kontakt - Kühlkörper / terminal to heatsink Kontakt - Kontakt / terminal to terminal			33,0 33,0		mm
Luftstrecke Clearance	Kontakt - Kühlkörper / terminal to heatsink Kontakt - Kontakt / terminal to terminal			19,0 19,0		mm
Vergleichszahl der Kriechwegbildung Comperative tracking index		CTI		> 400		
			min.	typ.	max.	
Modulstreuintuktivität Stray inductance module		L_{sCE}		18		nH
Modulleitungswiderstand, Anschlüsse - Chip Module lead resistance, terminals - chip	$T_C = 25^\circ\text{C}$, pro Schalter / per switch	$R_{\text{CC}+\text{EE}'}$		0,30		m Ω
Lagertemperatur Storage temperature		T_{stg}	-40		150	$^\circ\text{C}$
Anzugsdrehmoment f. Modulmontage Mounting torque for modul mounting	Schraube M5 - Montage gem. gültiger Applikationsschrift Screw M5 - Mounting according to valid application note	M	3,00	-	6,00	Nm
Anzugsdrehmoment f. elektr. Anschlüsse Terminal connection torque	Schraube M4 - Montage gem. gültiger Applikationsschrift Screw M4 - Mounting according to valid application note	M	1,8	-	2,1	Nm
	Schraube M8 - Montage gem. gültiger Applikationsschrift Screw M8 - Mounting according to valid application note		8,0	-	10	Nm
Gewicht Weight		G		825		g

prepared by: AC	date of publication: 2013-11-05
approved by: MS	revision: 2.2



Vorläufige Daten
Preliminary Data

Ausgangskennlinie IGBT-Chopper (typisch)
output characteristic IGBT-Chopper (typical)

$I_C = f(V_{CE})$
 $V_{GE} = 15\text{ V}$

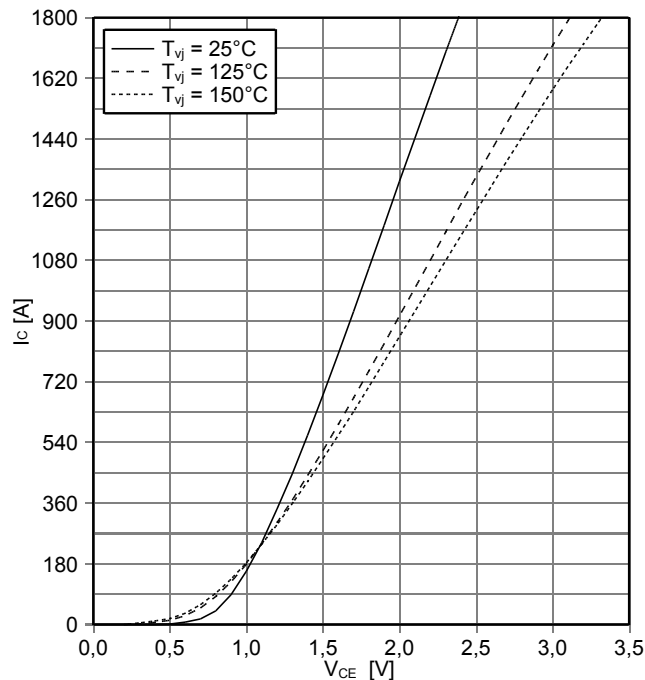

Ausgangskennlinienfeld IGBT-Chopper (typisch)
output characteristic IGBT-Chopper (typical)

$I_C = f(V_{CE})$
 $T_{vj} = 150^\circ\text{C}$

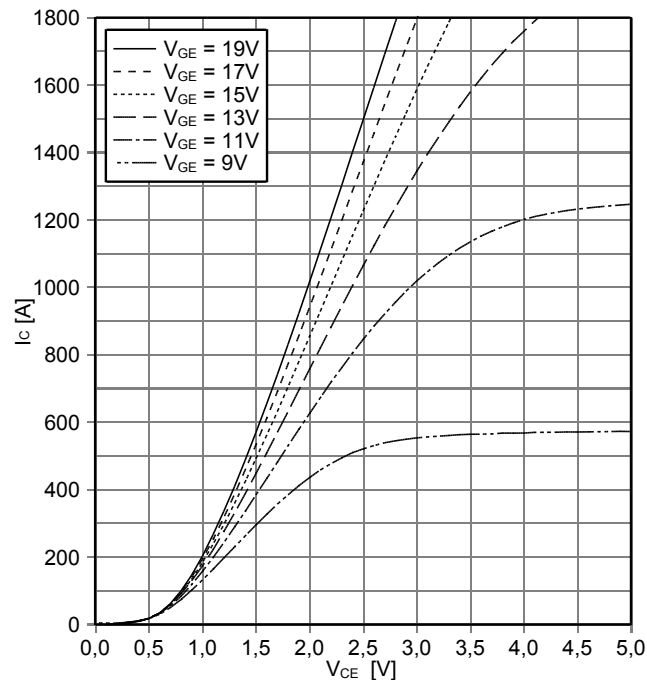

Übertragungscharakteristik IGBT-Chopper (typisch)
transfer characteristic IGBT-Chopper (typical)

$I_C = f(V_{GE})$
 $V_{CE} = 20\text{ V}$

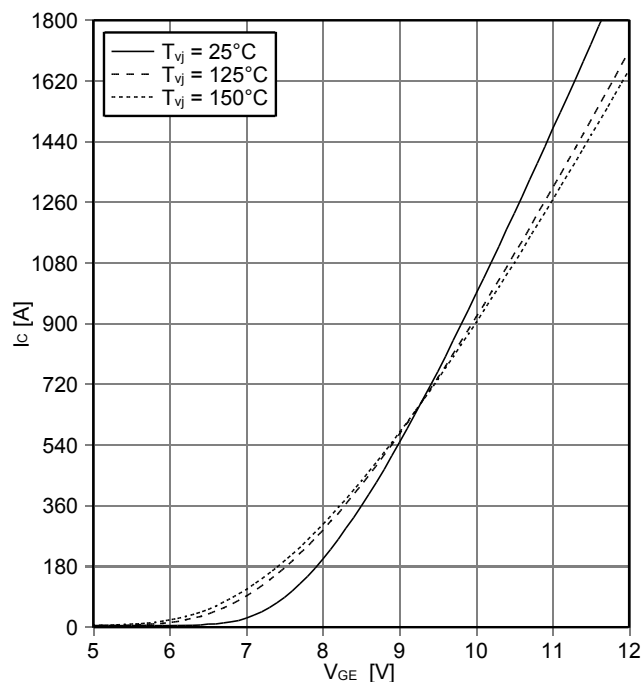

Schaltverluste IGBT-Chopper (typisch)
switching losses IGBT-Chopper (typical)

$E_{on} = f(I_C)$, $E_{off} = f(I_C)$
 $V_{GE} = \pm 15\text{ V}$, $R_{Gon} = 1.6\ \Omega$, $R_{Goff} = 1.6\ \Omega$, $V_{CE} = 600\text{ V}$

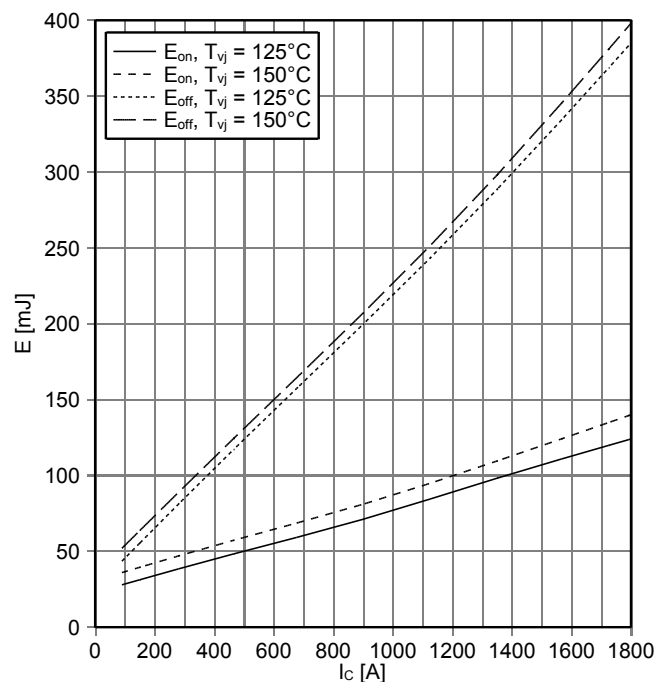

prepared by: AC	date of publication: 2013-11-05
approved by: MS	revision: 2.2

Vorläufige Daten
Preliminary Data

Schaltverluste IGBT-Chopper (typisch)
switching losses IGBT-Chopper (typical)

$E_{on} = f(R_G)$, $E_{off} = f(R_G)$
 $V_{GE} = \pm 15\text{ V}$, $I_C = 900\text{ A}$, $V_{CE} = 600\text{ V}$

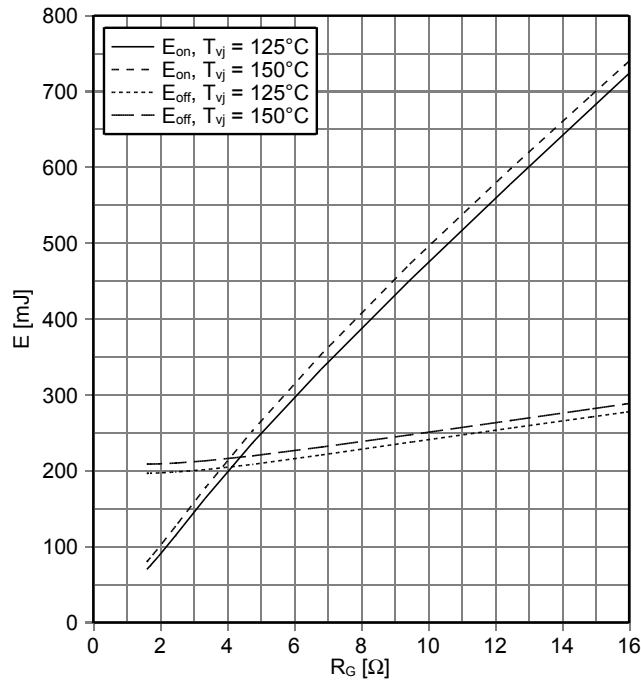

Transienter Wärmewiderstand IGBT-Chopper
transient thermal impedance IGBT-Chopper

$Z_{thJC} = f(t)$

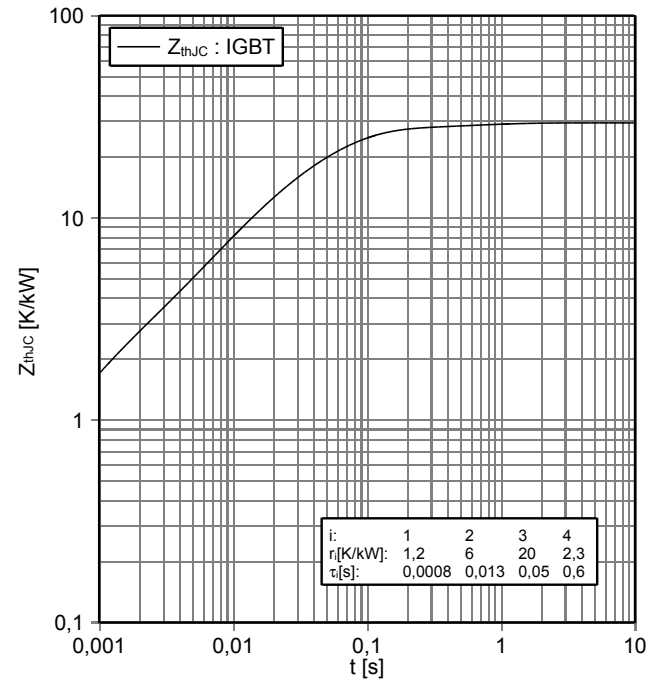

Sicherer Rückwärts-Arbeitsbereich IGBT-Chopper (RBSOA)
reverse bias safe operating area IGBT-Chopper (RBSOA)

$I_C = f(V_{CE})$
 $V_{GE} = \pm 15\text{ V}$, $R_{Goff} = 1.6\ \Omega$, $T_{vj} = 150^\circ\text{C}$

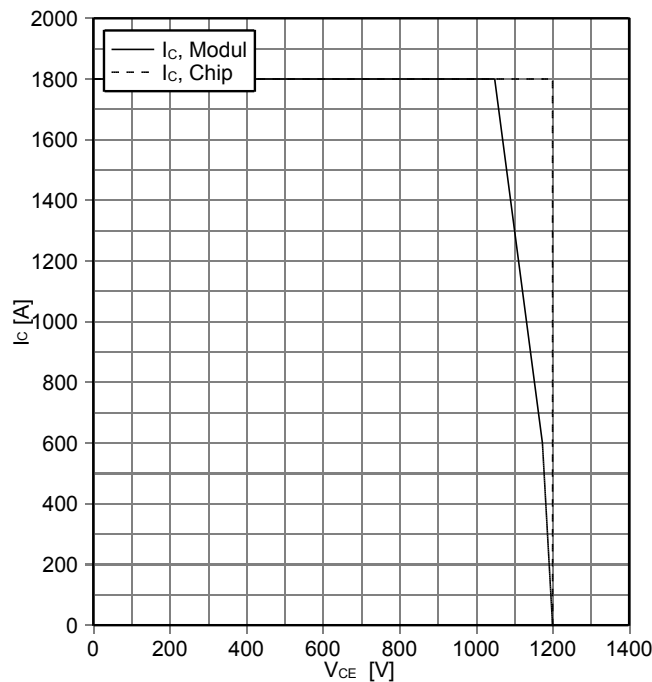

Durchlasskennlinie der Diode-Chopper (typisch)
forward characteristic of Diode-Chopper (typical)

$I_F = f(V_F)$

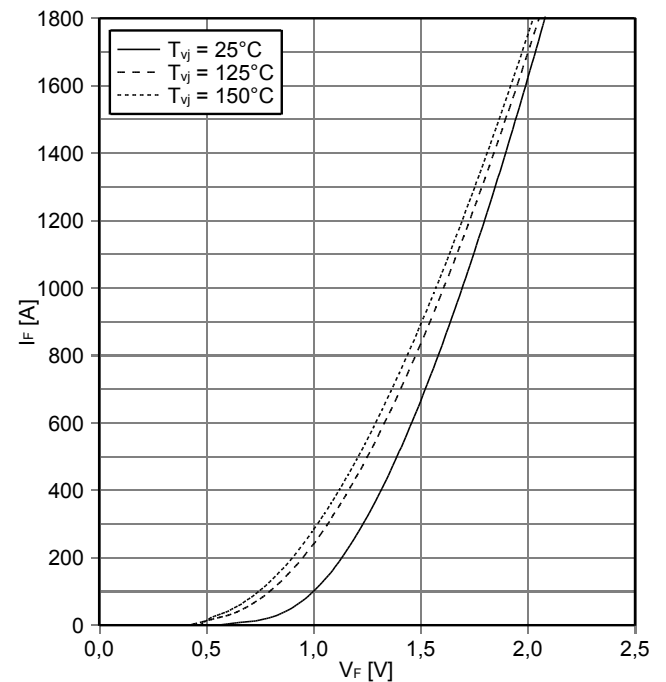

prepared by: AC	date of publication: 2013-11-05
approved by: MS	revision: 2.2

Vorläufige Daten
Preliminary Data

Schaltverluste Diode-Chopper (typisch)
switching losses Diode-Chopper (typical)

$E_{rec} = f(I_F)$
 $R_{Gon} = 1.6 \Omega, V_{CE} = 600 V$

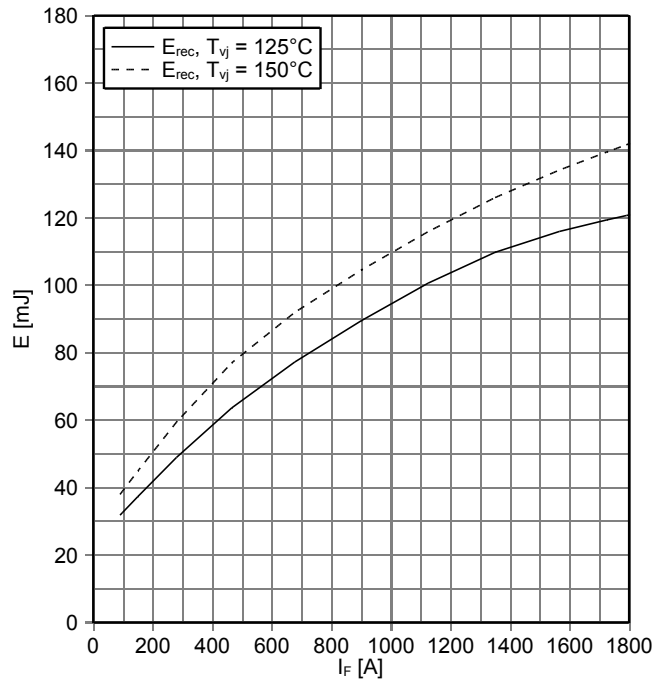

Schaltverluste Diode-Chopper (typisch)
switching losses Diode-Chopper (typical)

$E_{rec} = f(R_G)$
 $I_F = 900 A, V_{CE} = 600 V$

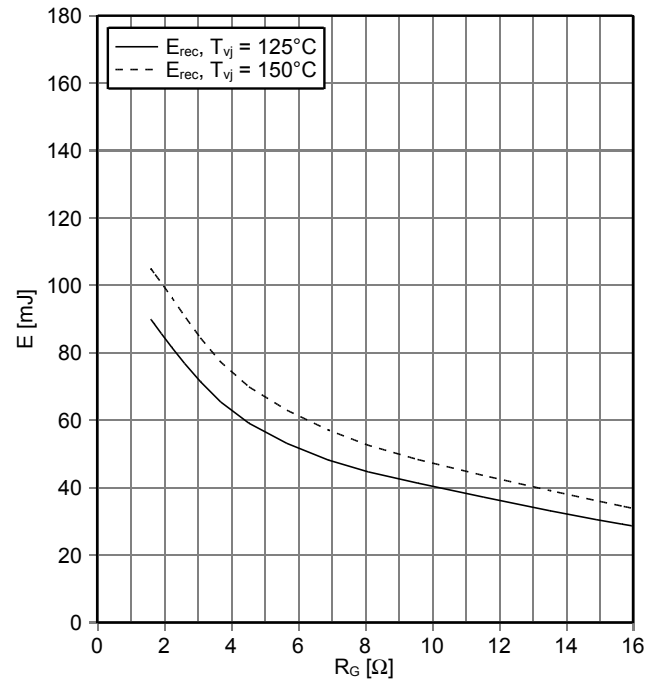

Transienter Wärmewiderstand Diode-Chopper
transient thermal impedance Diode-Chopper

$Z_{thJC} = f(t)$

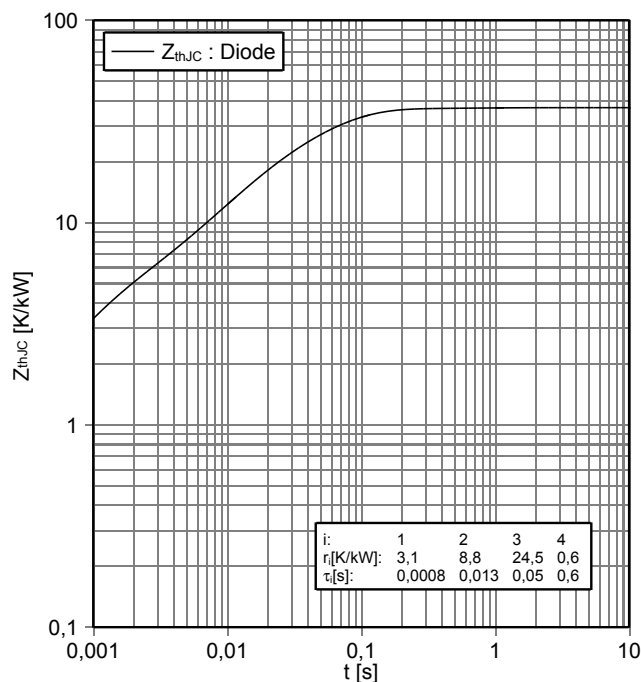

NTC-Widerstand-Temperaturkennlinie (typisch)
NTC-Thermistor-temperature characteristic (typical)

$R = f(T)$

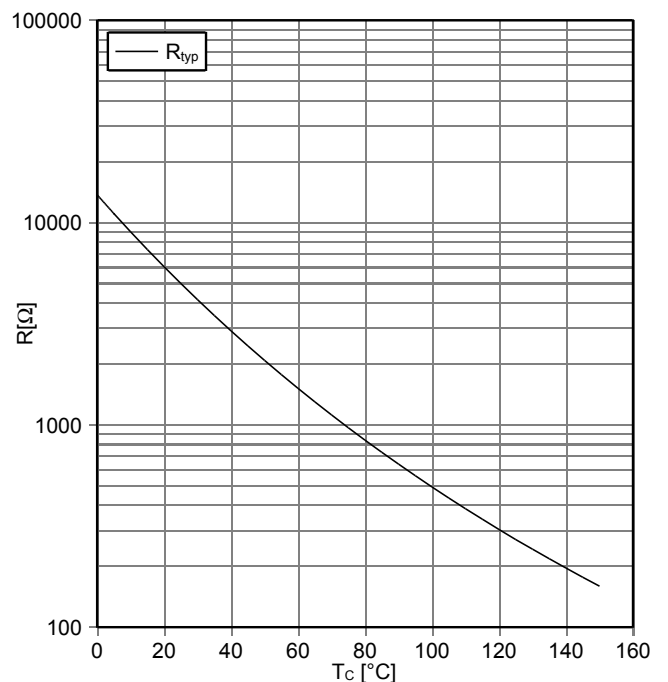

prepared by: AC	date of publication: 2013-11-05
approved by: MS	revision: 2.2



**Vorläufige Daten
Preliminary Data**

Nutzungsbedingungen

Die in diesem Produktdatenblatt enthaltenen Daten sind ausschließlich für technisch geschultes Fachpersonal bestimmt. Die Beurteilung der Eignung dieses Produktes für Ihre Anwendung sowie die Beurteilung der Vollständigkeit der bereitgestellten Produktdaten für diese Anwendung obliegt Ihnen bzw. Ihren technischen Abteilungen.

In diesem Produktdatenblatt werden diejenigen Merkmale beschrieben, für die wir eine liefervertragliche Gewährleistung übernehmen. Eine solche Gewährleistung richtet sich ausschließlich nach Maßgabe der im jeweiligen Liefervertrag enthaltenen Bestimmungen. Garantien jeglicher Art werden für das Produkt und dessen Eigenschaften keinesfalls übernommen. Die Angaben in den gültigen Anwendungs- und Montagehinweisen des Moduls sind zu beachten.

Sollten Sie von uns Produktinformationen benötigen, die über den Inhalt dieses Produktdatenblatts hinausgehen und insbesondere eine spezifische Verwendung und den Einsatz dieses Produktes betreffen, setzen Sie sich bitte mit dem für Sie zuständigen Vertriebsbüro in Verbindung (siehe www.infineon.com, Vertrieb&Kontakt). Für Interessenten halten wir Application Notes bereit.

Aufgrund der technischen Anforderungen könnte unser Produkt gesundheitsgefährdende Substanzen enthalten. Bei Rückfragen zu den in diesem Produkt jeweils enthaltenen Substanzen setzen Sie sich bitte ebenfalls mit dem für Sie zuständigen Vertriebsbüro in Verbindung.

Sollten Sie beabsichtigen, das Produkt in Anwendungen der Luftfahrt, in gesundheits- oder lebensgefährdenden oder lebenserhaltenden Anwendungsbereichen einzusetzen, bitten wir um Mitteilung. Wir weisen darauf hin, dass wir für diese Fälle

- die gemeinsame Durchführung eines Risiko- und Qualitätsassessments;
- den Abschluss von speziellen Qualitätssicherungsvereinbarungen;
- die gemeinsame Einführung von Maßnahmen zu einer laufenden Produktbeobachtung dringend empfehlen und gegebenenfalls die Belieferung von der Umsetzung solcher Maßnahmen abhängig machen.

Soweit erforderlich, bitten wir Sie, entsprechende Hinweise an Ihre Kunden zu geben.

Inhaltliche Änderungen dieses Produktdatenblatts bleiben vorbehalten.

Terms & Conditions of usage

The data contained in this product data sheet is exclusively intended for technically trained staff. You and your technical departments will have to evaluate the suitability of the product for the intended application and the completeness of the product data with respect to such application.

This product data sheet is describing the characteristics of this product for which a warranty is granted. Any such warranty is granted exclusively pursuant the terms and conditions of the supply agreement. There will be no guarantee of any kind for the product and its characteristics. The information in the valid application- and assembly notes of the module must be considered.

Should you require product information in excess of the data given in this product data sheet or which concerns the specific application of our product, please contact the sales office, which is responsible for you (see www.infineon.com). For those that are specifically interested we may provide application notes.

Due to technical requirements our product may contain dangerous substances. For information on the types in question please contact the sales office, which is responsible for you.

Should you intend to use the Product in aviation applications, in health or live endangering or life support applications, please notify. Please note, that for any such applications we urgently recommend

- to perform joint Risk and Quality Assessments;
- the conclusion of Quality Agreements;
- to establish joint measures of an ongoing product survey, and that we may make delivery depended on the realization of any such measures.

If and to the extent necessary, please forward equivalent notices to your customers.

Changes of this product data sheet are reserved.

prepared by: AC	date of publication: 2013-11-05
approved by: MS	revision: 2.2