



Chipsmall Limited consists of a professional team with an average of over 10 year of expertise in the distribution of electronic components. Based in Hongkong, we have already established firm and mutual-benefit business relationships with customers from,Europe,America and south Asia,supplying obsolete and hard-to-find components to meet their specific needs.

With the principle of “Quality Parts,Customers Priority,Honest Operation,and Considerate Service”,our business mainly focus on the distribution of electronic components. Line cards we deal with include Microchip,ALPS,ROHM,Xilinx,Pulse,ON,Everlight and Freescale. Main products comprise IC,Modules,Potentiometer,IC Socket,Relay,Connector.Our parts cover such applications as commercial,industrial, and automotives areas.

We are looking forward to setting up business relationship with you and hope to provide you with the best service and solution. Let us make a better world for our industry!



Contact us

Tel: +86-755-8981 8866 Fax: +86-755-8427 6832

Email & Skype: info@chipsmall.com Web: www.chipsmall.com

Address: A1208, Overseas Decoration Building, #122 Zhenhua RD., Futian, Shenzhen, China





Is Now Part of



ON Semiconductor®

To learn more about ON Semiconductor, please visit our website at
www.onsemi.com

ON Semiconductor and the ON Semiconductor logo are trademarks of Semiconductor Components Industries, LLC dba ON Semiconductor or its subsidiaries in the United States and/or other countries. ON Semiconductor owns the rights to a number of patents, trademarks, copyrights, trade secrets, and other intellectual property. A listing of ON Semiconductor's product/patent coverage may be accessed at www.onsemi.com/site/pdf/Patent-Marking.pdf. ON Semiconductor reserves the right to make changes without further notice to any products herein. ON Semiconductor makes no warranty, representation or guarantee regarding the suitability of its products for any particular purpose, nor does ON Semiconductor assume any liability arising out of the application or use of any product or circuit, and specifically disclaims any and all liability, including without limitation special, consequential or incidental damages. Buyer is responsible for its products and applications using ON Semiconductor products, including compliance with all laws, regulations and safety requirements or standards, regardless of any support or applications information provided by ON Semiconductor. "Typical" parameters which may be provided in ON Semiconductor data sheets and/or specifications can and do vary in different applications and actual performance may vary over time. All operating parameters, including "Typicals" must be validated for each customer application by customer's technical experts. ON Semiconductor does not convey any license under its patent rights nor the rights of others. ON Semiconductor products are not designed, intended, or authorized for use as a critical component in life support systems or any FDA Class 3 medical devices or medical devices with a same or similar classification in a foreign jurisdiction or any devices intended for implantation in the human body. Should Buyer purchase or use ON Semiconductor products for any such unintended or unauthorized application, Buyer shall indemnify and hold ON Semiconductor and its officers, employees, subsidiaries, affiliates, and distributors harmless against all claims, costs, damages, and expenses, and reasonable attorney fees arising out of, directly or indirectly, any claim of personal injury or death associated with such unintended or unauthorized use, even if such claim alleges that ON Semiconductor was negligent regarding the design or manufacture of the part. ON Semiconductor is an Equal Opportunity/Affirmative Action Employer. This literature is subject to all applicable copyright laws and is not for resale in any manner.



FDMC5614P

P-Channel PowerTrench[®] MOSFET

-60V, -13.5A, 100mΩ

Features

- Max $r_{DS(on)}$ = 100mΩ at $V_{GS} = -10V$, $I_D = -5.7A$
- Max $r_{DS(on)}$ = 135mΩ at $V_{GS} = -4.5V$, $I_D = -4.4A$
- Low gate charge
- Fast switching speed
- High performance trench technology for extremely low $r_{DS(on)}$
- High power and current handling capability
- RoHS Compliant



General Description

This P-Channel MOSFET is a rugged gate version of Fairchild Semiconductor's advanced PowerTrench[®] process. It has been optimized for power management applications requiring a wide range of gate drive voltage ratings (4.5V-20V).

Application

- Power management
- Load switch
- Battery protection

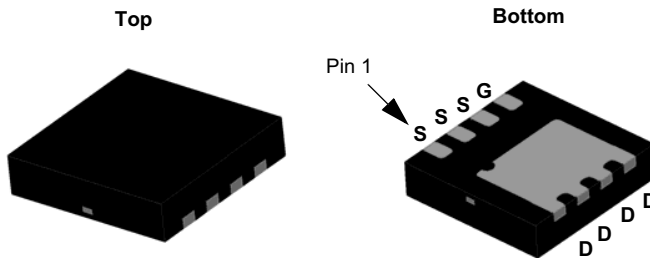

MLP 3.3x3.3

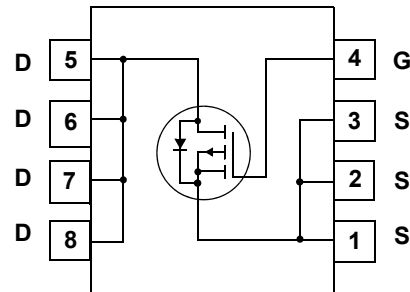

MOSFET Maximum Ratings $T_A = 25^\circ\text{C}$ unless otherwise noted

Symbol	Parameter	Rated	Units
V_{DS}	Drain to Source Voltage	-60	V
V_{GS}	Gate to Source Voltage	± 20	V
I_D	Drain Current -Continuous (Package limited) $T_C = 25^\circ\text{C}$	-13.5	A
	-Continuous (Silicon limited) $T_C = 25^\circ\text{C}$	-14	
	-Continuous $T_A = 25^\circ\text{C}$ (Note 1a)	-5.7	
	-Pulsed	-23	
P_D	Power Dissipation $T_C = 25^\circ\text{C}$	42	W
	Power Dissipation $T_A = 25^\circ\text{C}$ (Note 1a)	2.1	
T_J, T_{STG}	Operating and Storage Junction Temperature Range	-55 to +150	$^\circ\text{C}$

Thermal Characteristics

$R_{\theta JC}$	Thermal Resistance, Junction to Case	3.0	$^\circ\text{C/W}$
$R_{\theta JA}$	Thermal Resistance, Junction to Ambient (Note 1a)	60	

Package Marking and Ordering Information

Device Marking	Device	Package	Reel Size	Tape Width	Quantity
5614P	FDMC5614P	Power 33	7"	8mm	3000 units

Electrical Characteristics $T_J = 25^\circ\text{C}$ unless otherwise noted

Symbol	Parameter	Test Conditions	Min	Typ	Max	Units
--------	-----------	-----------------	-----	-----	-----	-------

Off Characteristics

BV_{DSS}	Drain to Source Breakdown Voltage	$I_D = -250\mu\text{A}, V_{GS} = 0\text{V}$	-60			V
$\frac{\Delta BV_{DSS}}{\Delta T_J}$	Breakdown Voltage Temperature Coefficient	$I_D = -250\mu\text{A}$, referenced to 25°C		-54		mV/ $^\circ\text{C}$
I_{DSS}	Zero Gate Voltage Drain Current	$V_{DS} = -48\text{V}, V_{GS} = 0\text{V}$			-1	μA
I_{GSS}	Gate to Source Leakage Current	$V_{GS} = \pm 20\text{V}, V_{DS} = 0\text{V}$			± 100	nA

On Characteristics

$V_{GS(th)}$	Gate to Source Threshold Voltage	$V_{GS} = V_{DS}, I_D = -250\mu\text{A}$	-1	-1.95	-3	V
$\frac{\Delta V_{GS(th)}}{\Delta T_J}$	Gate to Source Threshold Voltage Temperature Coefficient	$I_D = -250\mu\text{A}$, referenced to 25°C		4.7		mV/ $^\circ\text{C}$
$r_{DS(on)}$	Static Drain to Source On Resistance	$V_{GS} = -10\text{V}, I_D = -5.7\text{A}$		84	100	m Ω
		$V_{GS} = -4.5\text{V}, I_D = -4.4\text{A}$		108	135	
		$V_{GS} = -10\text{V}, I_D = -5.7\text{A}, T_J = 125^\circ\text{C}$		140	168	
g_{FS}	Forward Transconductance	$V_{DS} = -15\text{V}, I_D = -5.7\text{A}$		11		S

Dynamic Characteristics

C_{iss}	Input Capacitance	$V_{DS} = -30\text{V}, V_{GS} = 0\text{V}, f = 1\text{MHz}$		795	1055	pF
C_{oss}	Output Capacitance			140	185	pF
C_{rss}	Reverse Transfer Capacitance			60	90	pF

Switching Characteristics

$t_{d(on)}$	Turn-On Delay Time	$V_{DD} = -30\text{V}, I_D = -1\text{A}, V_{GS} = -10\text{V}, R_{GEN} = 6\Omega$		10	21	ns
t_r	Rise Time			11	23	ns
$t_{d(off)}$	Turn-Off Delay Time			32	65	ns
t_f	Fall Time			11	22	ns
$Q_{g(TOT)}$	Total Gate Charge at 10V		$V_{GS} = -10\text{V}$		15	20
Q_{gs}	Gate to Source Gate Charge	$V_{DD} = -30\text{V}, I_D = -5.7\text{A}$		1.6	2.1	nC
Q_{gd}	Gate to Drain "Miller" Charge			2.7	3.5	nC

Drain-Source Diode Characteristics

V_{SD}	Source to Drain Diode Forward Voltage	$V_{GS} = 0\text{V}, I_S = -3.2\text{A}$		-0.8	-1.2	V
t_{rr}	Reverse Recovery Time	$I_F = -3.2\text{A}, di/dt = 100\text{A}/\mu\text{s}$			36	ns
Q_{rr}	Reverse Recovery Charge				29	nC

Notes:

1: $R_{\theta JA}$ is determined with the device mounted on a 1 in² oz copper pad on a 1.5 x 1.5 in. board of FR-4 material. $R_{\theta JC}$ is guaranteed by design while $R_{\theta JA}$ is determined by the user's board design.

(a) $R_{\theta JA} = 60^\circ\text{C}/\text{W}$ when mounted on a 1 in² pad of 2 oz copper, 1.5"x1.5"x0.062" thick PCB.

(b) $R_{\theta JA} = 135^\circ\text{C}/\text{W}$ when mounted on a minimum pad of 2 oz copper.

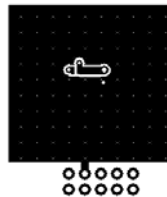

a. $60^\circ\text{C}/\text{W}$ when mounted on a 1 in² pad of 2 oz copper



b. $135^\circ\text{C}/\text{W}$ when mounted on a minimum pad of 2 oz copper

2: Pulse Test: Pulse Width < 300 μs , Duty cycle < 2.0%.

Typical Characteristics $T_J = 25^\circ\text{C}$ unless otherwise noted

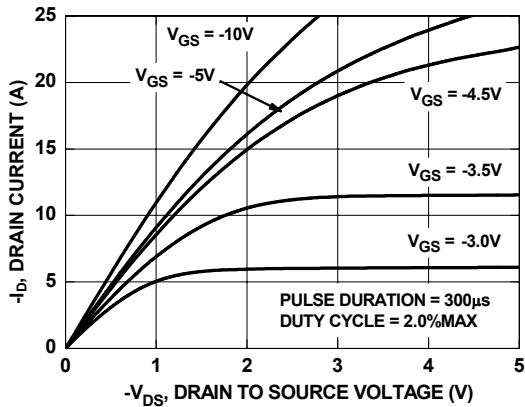

Figure 1. On-Region Characteristics

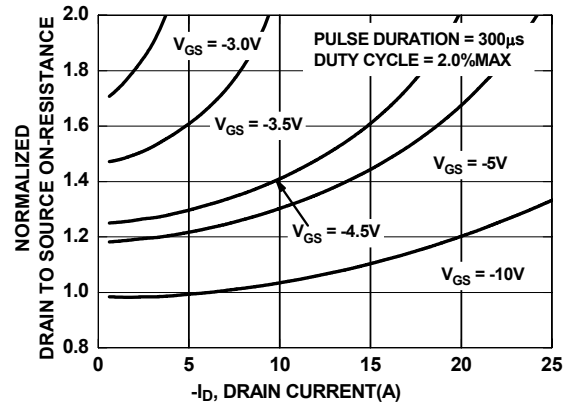

Figure 2. Normalized On-Resistance vs Drain Current and Gate Voltage

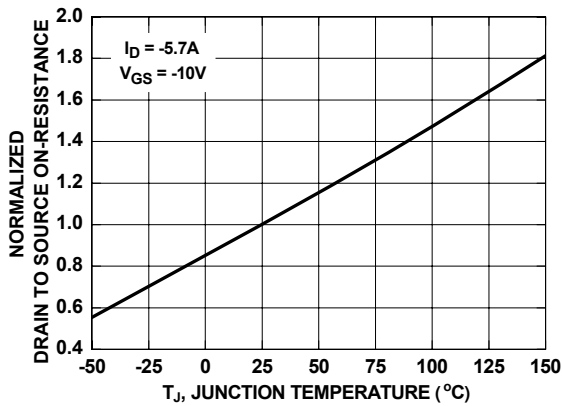

Figure 3. Normalized On-Resistance vs Junction Temperature

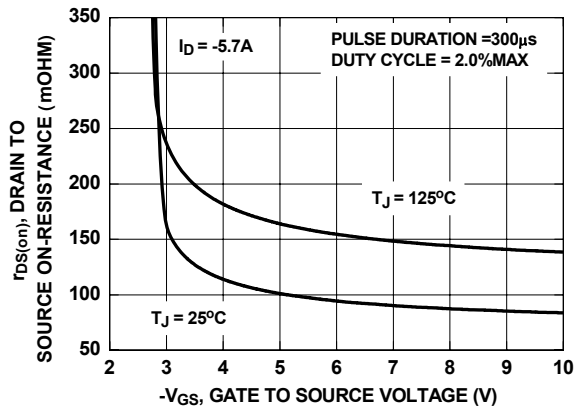

Figure 4. On-Resistance vs Gate to Source Voltage

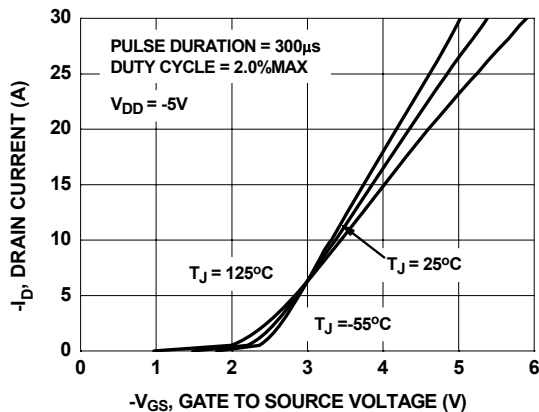

Figure 5. Transfer Characteristics

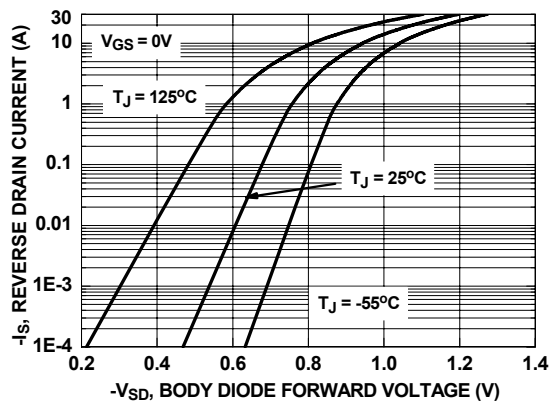

Figure 6. Source to Drain Diode Forward Voltage vs Source Current

Typical Characteristics $T_J = 25^\circ\text{C}$ unless otherwise noted

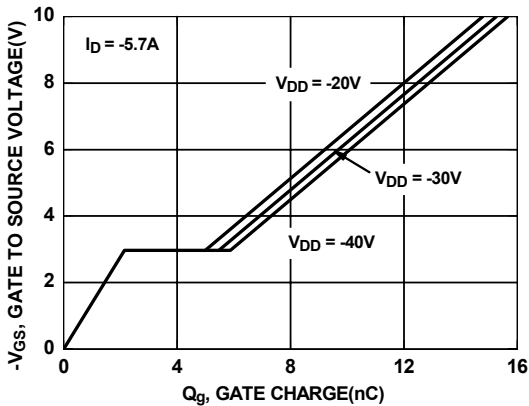

Figure 7. Gate Charge Characteristics

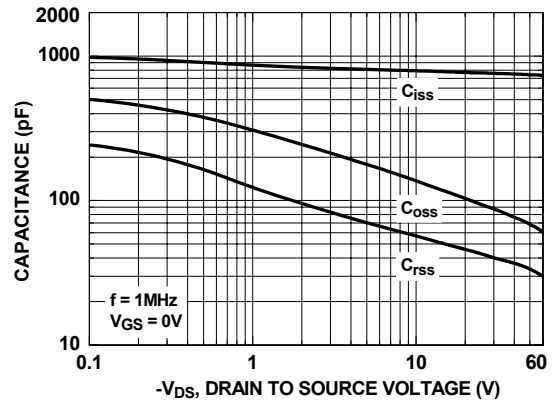

Figure 8. Capacitance vs Drain to Source Voltage

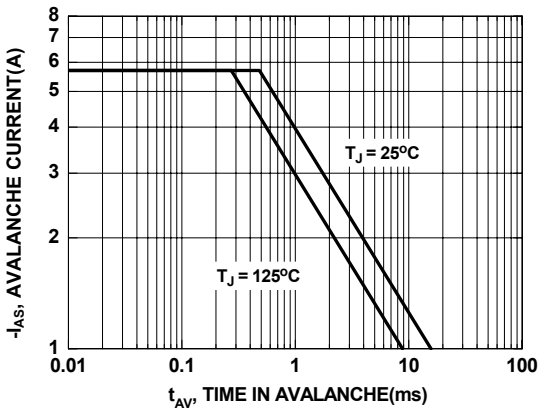

Figure 9. Unclamped Inductive Switching Capability

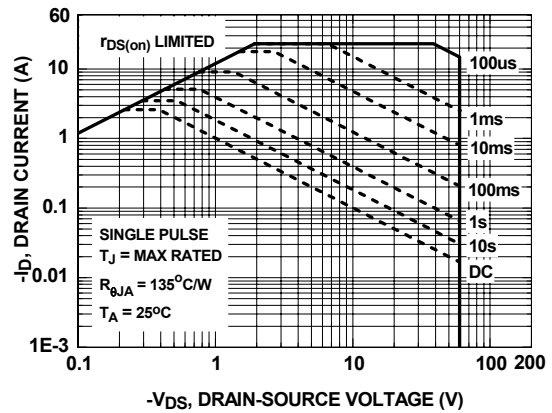

Figure 10. Forward Bias Safe Operating Area

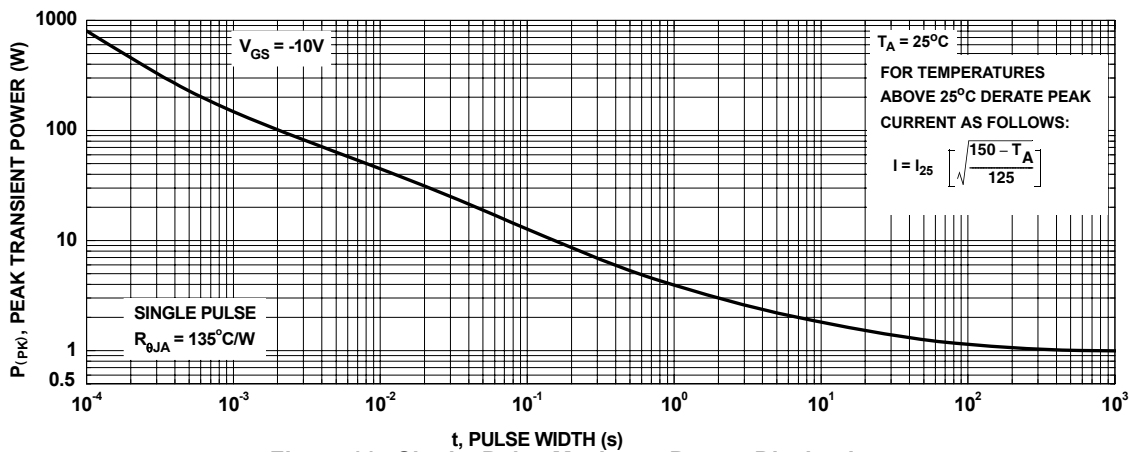

Figure 11. Single Pulse Maximum Power Dissipation

Typical Characteristics $T_J = 25^\circ\text{C}$ unless otherwise noted

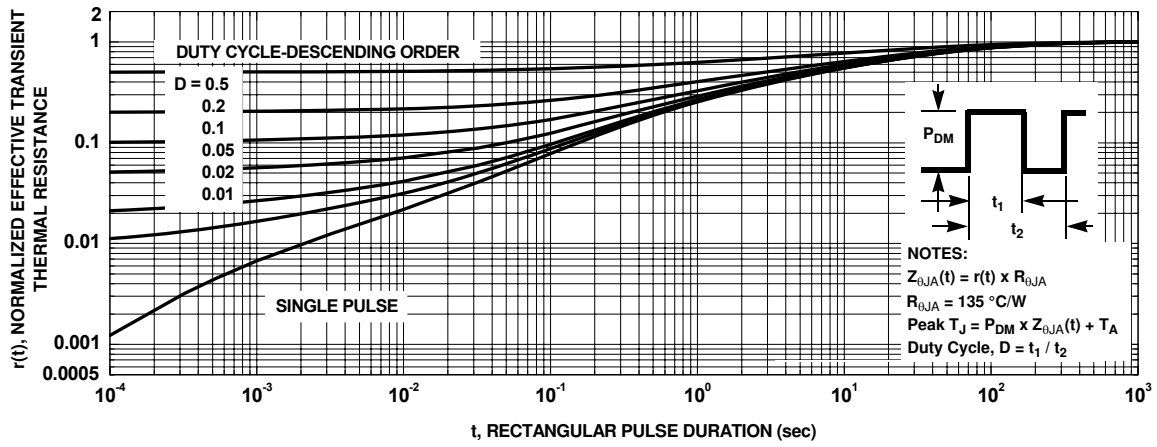
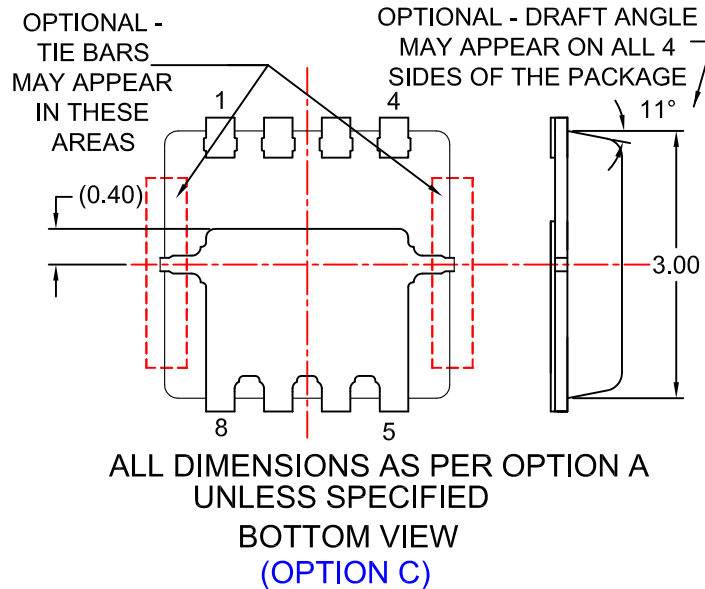
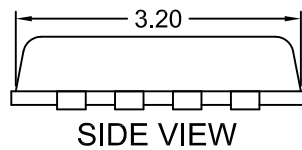
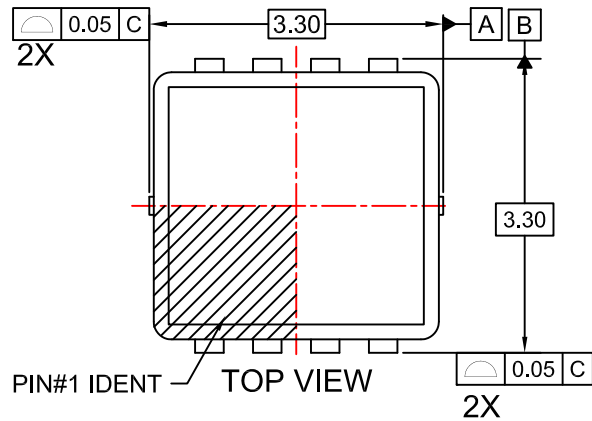

Figure 12. Transient Thermal Response Curve



NOTES:

- A. PACKAGE DOES NOT FULLY CONFORM TO JEDEC REGISTRATION MO-240.
- B. DIMENSIONS ARE IN MILLIMETERS.
- C. DIMENSIONS AND TOLERANCES PER ASME Y14.5M, 2009.
- D. LAND PATTERN RECOMMENDATION IS EXISTING INDUSTRY LAND PATTERN
- E. DIMENSIONS DO NOT INCLUDE BURRS OR MOLD FLASH. BURRS OR MOLD FLASH SHALL NOT EXCEED 0.10MM.
- F. DRAWING FILENAME: MKT-MLP08Wrev3.
- G. OPTION A - SAWN MLP, OPTIONS B & C - PUNCH MLP.



ON Semiconductor and  are trademarks of Semiconductor Components Industries, LLC dba ON Semiconductor or its subsidiaries in the United States and/or other countries. ON Semiconductor owns the rights to a number of patents, trademarks, copyrights, trade secrets, and other intellectual property. A listing of ON Semiconductor's product/patent coverage may be accessed at www.onsemi.com/site/pdf/Patent-Marking.pdf. ON Semiconductor reserves the right to make changes without further notice to any products herein. ON Semiconductor makes no warranty, representation or guarantee regarding the suitability of its products for any particular purpose, nor does ON Semiconductor assume any liability arising out of the application or use of any product or circuit, and specifically disclaims any and all liability, including without limitation special, consequential or incidental damages. Buyer is responsible for its products and applications using ON Semiconductor products, including compliance with all laws, regulations and safety requirements or standards, regardless of any support or applications information provided by ON Semiconductor. "Typical" parameters which may be provided in ON Semiconductor data sheets and/or specifications can and do vary in different applications and actual performance may vary over time. All operating parameters, including "Typicals" must be validated for each customer application by customer's technical experts. ON Semiconductor does not convey any license under its patent rights nor the rights of others. ON Semiconductor products are not designed, intended, or authorized for use as a critical component in life support systems or any FDA Class 3 medical devices or medical devices with a same or similar classification in a foreign jurisdiction or any devices intended for implantation in the human body. Should Buyer purchase or use ON Semiconductor products for any such unintended or unauthorized application, Buyer shall indemnify and hold ON Semiconductor and its officers, employees, subsidiaries, affiliates, and distributors harmless against all claims, costs, damages, and expenses, and reasonable attorney fees arising out of, directly or indirectly, any claim of personal injury or death associated with such unintended or unauthorized use, even if such claim alleges that ON Semiconductor was negligent regarding the design or manufacture of the part. ON Semiconductor is an Equal Opportunity/Affirmative Action Employer. This literature is subject to all applicable copyright laws and is not for resale in any manner.

PUBLICATION ORDERING INFORMATION

LITERATURE FULFILLMENT:

Literature Distribution Center for ON Semiconductor
19521 E. 32nd Pkwy, Aurora, Colorado 80011 USA
Phone: 303-675-2175 or 800-344-3860 Toll Free USA/Canada
Fax: 303-675-2176 or 800-344-3867 Toll Free USA/Canada
Email: orderlit@onsemi.com

N. American Technical Support: 800-282-9855 Toll Free
USA/Canada
Europe, Middle East and Africa Technical Support:
Phone: 421 33 790 2910
Japan Customer Focus Center
Phone: 81-3-5817-1050

ON Semiconductor Website: www.onsemi.com
Order Literature: <http://www.onsemi.com/orderlit>
For additional information, please contact your local
Sales Representative