



Chipsmall Limited consists of a professional team with an average of over 10 year of expertise in the distribution of electronic components. Based in Hongkong, we have already established firm and mutual-benefit business relationships with customers from,Europe,America and south Asia,supplying obsolete and hard-to-find components to meet their specific needs.

With the principle of “Quality Parts,Customers Priority,Honest Operation,and Considerate Service”,our business mainly focus on the distribution of electronic components. Line cards we deal with include Microchip,ALPS,ROHM,Xilinx,Pulse,ON,Everlight and Freescale. Main products comprise IC,Modules,Potentiometer,IC Socket,Relay,Connector.Our parts cover such applications as commercial,industrial, and automotives areas.

We are looking forward to setting up business relationship with you and hope to provide you with the best service and solution. Let us make a better world for our industry!



Contact us

Tel: +86-755-8981 8866 Fax: +86-755-8427 6832

Email & Skype: info@chipsmall.com Web: www.chipsmall.com

Address: A1208, Overseas Decoration Building, #122 Zhenhua RD., Futian, Shenzhen, China





Is Now Part of



ON Semiconductor®

To learn more about ON Semiconductor, please visit our website at

www.onsemi.com

ON Semiconductor and the ON Semiconductor logo are trademarks of Semiconductor Components Industries, LLC dba ON Semiconductor or its subsidiaries in the United States and/or other countries. ON Semiconductor owns the rights to a number of patents, trademarks, copyrights, trade secrets, and other intellectual property. A listing of ON Semiconductor's product/patent coverage may be accessed at www.onsemi.com/site/pdf/Patent-Marking.pdf. ON Semiconductor reserves the right to make changes without further notice to any products herein. ON Semiconductor makes no warranty, representation or guarantee regarding the suitability of its products for any particular purpose, nor does ON Semiconductor assume any liability arising out of the application or use of any product or circuit, and specifically disclaims any and all liability, including without limitation special, consequential or incidental damages. Buyer is responsible for its products and applications using ON Semiconductor products, including compliance with all laws, regulations and safety requirements or standards, regardless of any support or applications information provided by ON Semiconductor. "Typical" parameters which may be provided in ON Semiconductor data sheets and/or specifications can and do vary in different applications and actual performance may vary over time. All operating parameters, including "Typicals" must be validated for each customer application by customer's technical experts. ON Semiconductor does not convey any license under its patent rights nor the rights of others. ON Semiconductor products are not designed, intended, or authorized for use as a critical component in life support systems or any FDA Class 3 medical devices or medical devices with a same or similar classification in a foreign jurisdiction or any devices intended for implantation in the human body. Should Buyer purchase or use ON Semiconductor products for any such unintended or unauthorized application, Buyer shall indemnify and hold ON Semiconductor and its officers, employees, subsidiaries, affiliates, and distributors harmless against all claims, costs, damages, and expenses, and reasonable attorney fees arising out of, directly or indirectly, any claim of personal injury or death associated with such unintended or unauthorized use, even if such claim alleges that ON Semiconductor was negligent regarding the design or manufacture of the part. ON Semiconductor is an Equal Opportunity/Affirmative Action Employer. This literature is subject to all applicable copyright laws and is not for resale in any manner.



FDS6612A

Single N-Channel, Logic-Level, PowerTrench® MOSFET

General Description

This N-Channel Logic Level MOSFET is produced using Fairchild Semiconductor's advanced PowerTrench process that has been especially tailored to minimize the on-state resistance and yet maintain superior switching performance.

These devices are well suited for low voltage and battery powered applications where low in-line power loss and fast switching are required.



Features

- 8.4 A, 30 V. $R_{DS(ON)} = 22\text{ m}\Omega @ V_{GS} = 10\text{ V}$
 $R_{DS(ON)} = 30\text{ m}\Omega @ V_{GS} = 4.5\text{ V}$
- Fast switching speed
- Low gate charge
- High performance trench technology for extremely low $R_{DS(ON)}$
- High power and current handling capability

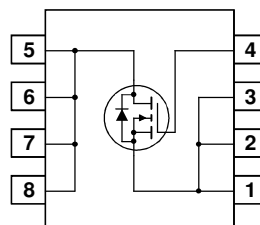
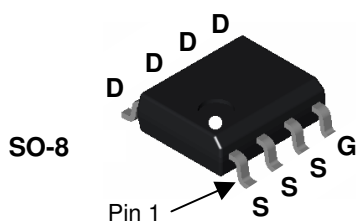

Absolute Maximum Ratings T_A=25°C unless otherwise noted

Symbol	Parameter	Ratings	Units
V _{DSS}	Drain-Source Voltage	30	V
V _{GSS}	Gate-Source Voltage	±20	V
I _D	Drain Current – Continuous (Note 1a)	8.4	A
	– Pulsed	40	
P _D	Power Dissipation for Single Operation (Note 1a)	2.5	W
	(Note 1b)	1.0	
E _{AS}	Single Pulse Avalanche Energy (Note 3)	24	mJ
T _J , T _{STG}	Operating and Storage Junction Temperature Range	-55 to +150	°C

Thermal Characteristics

R _{θJA}	Thermal Resistance, Junction-to-Ambient (Note 1a)	50	°C/W
R _{θJA}	Thermal Resistance, Junction-to-Ambient (Note 1b)	125	
R _{θJC}	Thermal Resistance, Junction-to-Case (Note 1)	25	

Package Marking and Ordering Information

Device Marking	Device	Reel Size	Tape width	Quantity
FDS6612A	FDS6612A	13"	12mm	2500 units

Electrical Characteristics

$T_A = 25^\circ\text{C}$ unless otherwise noted

Symbol	Parameter	Test Conditions	Min	Typ	Max	Units
--------	-----------	-----------------	-----	-----	-----	-------

Off Characteristics

BV_{DSS}	Drain-Source Breakdown Voltage	$V_{GS} = 0\text{ V}, I_D = 250\ \mu\text{A}$	30			V
$\frac{\Delta BV_{DSS}}{\Delta T_J}$	Breakdown Voltage Temperature Coefficient	$I_D = 250\ \mu\text{A}$, Referenced to 25°C		26		mV/ $^\circ\text{C}$
I_{DSS}	Zero Gate Voltage Drain Current	$V_{DS} = 24\text{ V}, V_{GS} = 0\text{ V}$			1	μA
		$V_{DS} = 24\text{ V}, V_{GS} = 0\text{ V}, T_J = 55^\circ\text{C}$			10	μA
I_{GSS}	Gate-Body Leakage	$V_{GS} = \pm 20\text{ V}, V_{DS} = 0\text{ V}$			± 100	nA

On Characteristics (Note 2)

$V_{GS(th)}$	Gate Threshold Voltage	$V_{DS} = V_{GS}, I_D = 250\ \mu\text{A}$	1	1.9	3	V
$\frac{\Delta V_{GS(th)}}{\Delta T_J}$	Gate Threshold Voltage Temperature Coefficient	$I_D = 250\ \mu\text{A}$, Referenced to 25°C		-4.4		mV/ $^\circ\text{C}$
$R_{DS(on)}$	Static Drain-Source On-Resistance	$V_{GS} = 10\text{ V}, I_D = 8.4\text{ A}$		19	22	m Ω
		$V_{GS} = 4.5\text{ V}, I_D = 7.2\text{ A}$		24	30	
		$V_{GS} = 10\text{ V}, I_D = 8.4\text{ A}, T_J = 125^\circ\text{C}$		25	37	
$I_{D(on)}$	On-State Drain Current	$V_{GS} = 10\text{ V}, V_{DS} = 5\text{ V}$	20			A
g_{FS}	Forward Transconductance	$V_{DS} = 15\text{ V}, I_D = 8.4\text{ A}$		30		S

Dynamic Characteristics

C_{iss}	Input Capacitance	$V_{DS} = 15\text{ V}, V_{GS} = 0\text{ V}, f = 1.0\text{ MHz}$		560		pF
C_{oss}	Output Capacitance			140		pF
C_{rss}	Reverse Transfer Capacitance			55		pF
R_G	Gate Resistance	$V_{GS} = 15\text{ mV}, f = 1.0\text{ MHz}$		2.5		Ω

Switching Characteristics (Note 2)

$t_{d(on)}$	Turn-On Delay Time	$V_{DD} = 15\text{ V}, I_D = 1\text{ A}, V_{GS} = 10\text{ V}, R_{GEN} = 6\ \Omega$		7	14	ns
t_r	Turn-On Rise Time			5	10	ns
$t_{d(off)}$	Turn-Off Delay Time			22	35	ns
t_f	Turn-Off Fall Time			3	6	ns
Q_g	Total Gate Charge	$V_{DS} = 15\text{ V}, I_D = 8.4\text{ A}, V_{GS} = 5\text{ V}$		5.4	7.6	nC
Q_{gs}	Gate-Source Charge			1.7		nC
Q_{gd}	Gate-Drain Charge			1.9		nC

Drain-Source Diode Characteristics and Maximum Ratings

I_S	Maximum Continuous Drain-Source Diode Forward Current			2.1		A
V_{SD}	Drain-Source Diode Forward Voltage	$V_{GS} = 0\text{ V}, I_S = 2.1\text{ A}$ (Note 2)		0.77	1.2	V
t_{rr}	Diode Reverse Recovery Time	$I_F = 8.4\text{ A}, d_I/d_t = 100\text{ A}/\mu\text{s}$		19		nS
Q_{rr}	Diode Reverse Recovery Charge			9		nC

Notes:

- $R_{\theta JA}$ is the sum of the junction-to-case and case-to-ambient thermal resistance where the case thermal reference is defined as the solder mounting surface of the drain pins. $R_{\theta JC}$ is guaranteed by design while $R_{\theta CA}$ is determined by the user's board design.

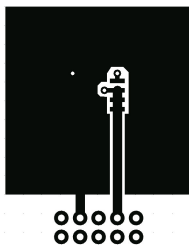

a) $50^\circ\text{C}/\text{W}$ when mounted on a 1 in^2 pad of 2 oz copper



b) $125^\circ\text{C}/\text{W}$ when mounted on a minimum pad.

Scale 1 : 1 on letter size paper

- Test: Pulse Width < $300\ \mu\text{s}$, Duty Cycle < 2.0%
- Starting $T_J = 25^\circ\text{C}$, $L = 1\text{ mH}$, $I_{AS} = 7\text{ A}$, $V_{DD} = 27\text{ V}$, $V_{GS} = 10\text{ V}$

Typical Characteristics

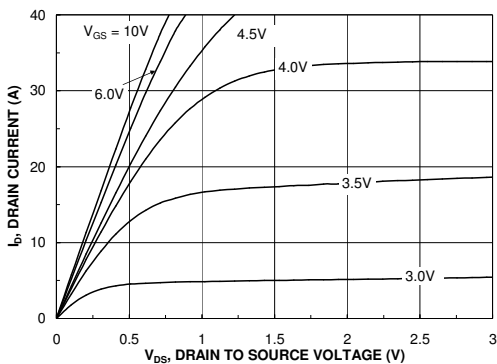

Figure 1. On-Region Characteristics.

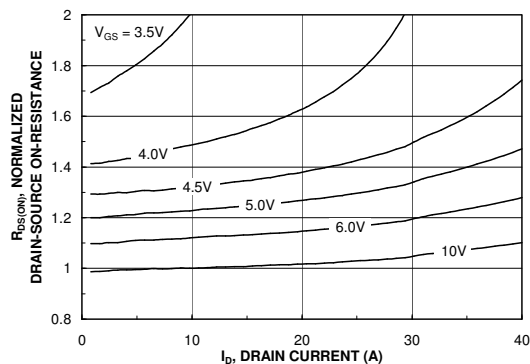

Figure 2. On-Resistance Variation with Drain Current and Gate Voltage.

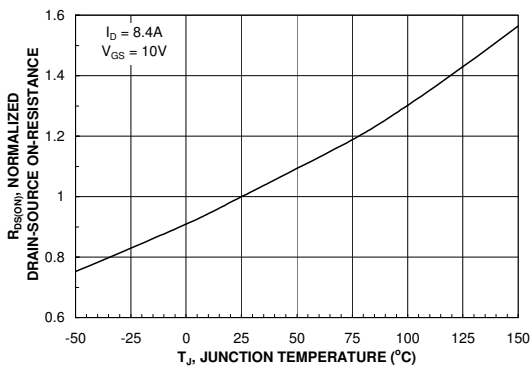

Figure 3. On-Resistance Variation with Temperature.

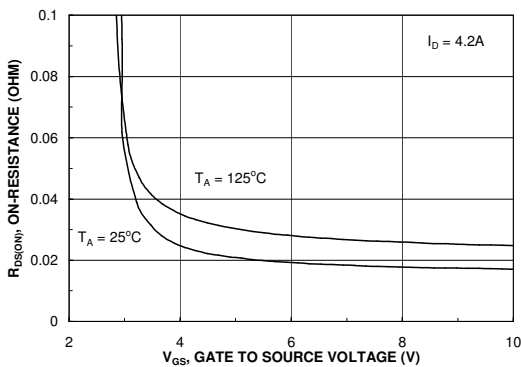

Figure 4. On-Resistance Variation with Gate-to-Source Voltage.

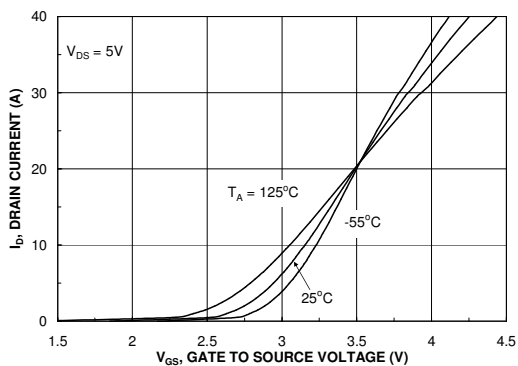

Figure 5. Transfer Characteristics.

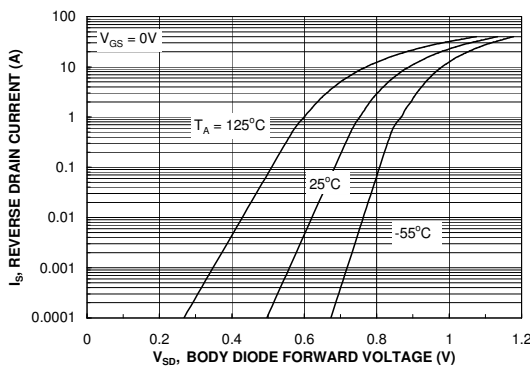

Figure 6. Body Diode Forward Voltage Variation with Source Current and Temperature.

Typical Characteristics

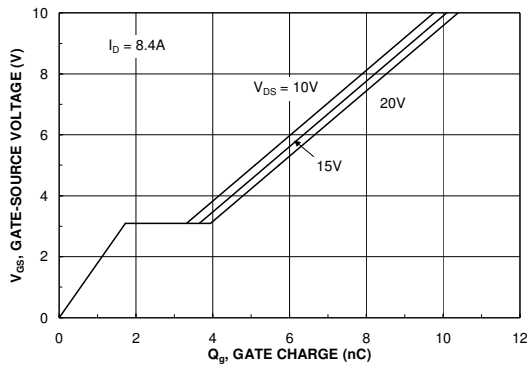

Figure 7. Gate Charge Characteristics.

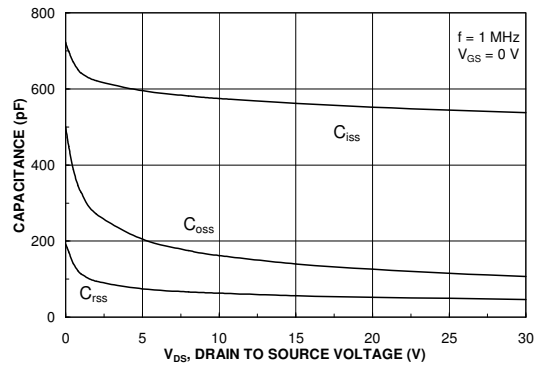

Figure 8. Capacitance Characteristics.

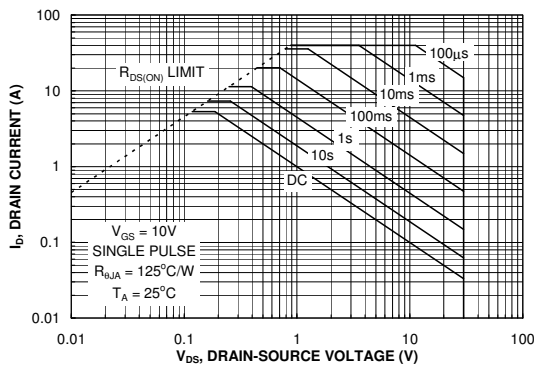

Figure 9. Maximum Safe Operating Area.

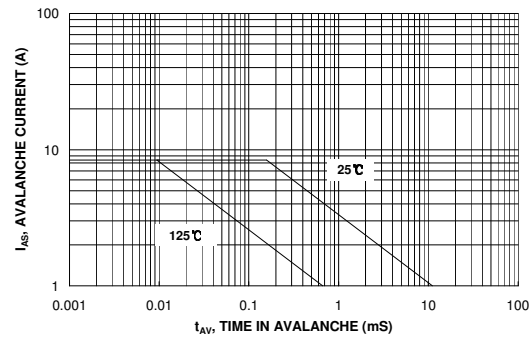

Figure 10. Unclamped Inductive Switching Capability

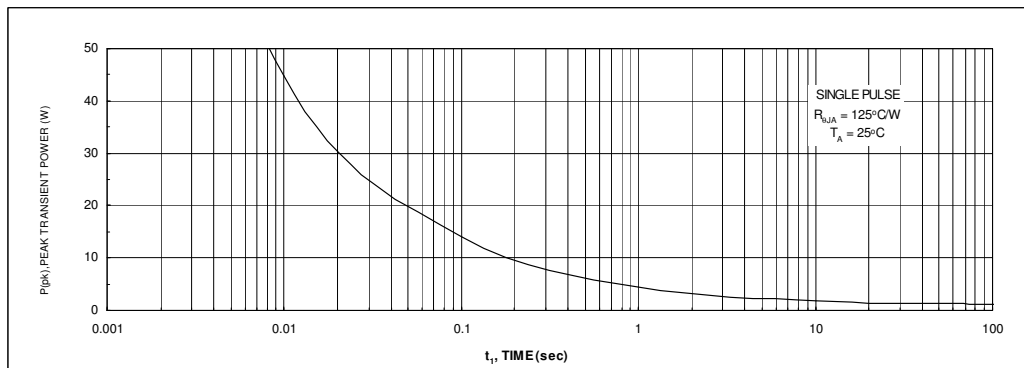

Figure 11. Single Pulse Maximum Power Dissipation.

Typical Characteristics

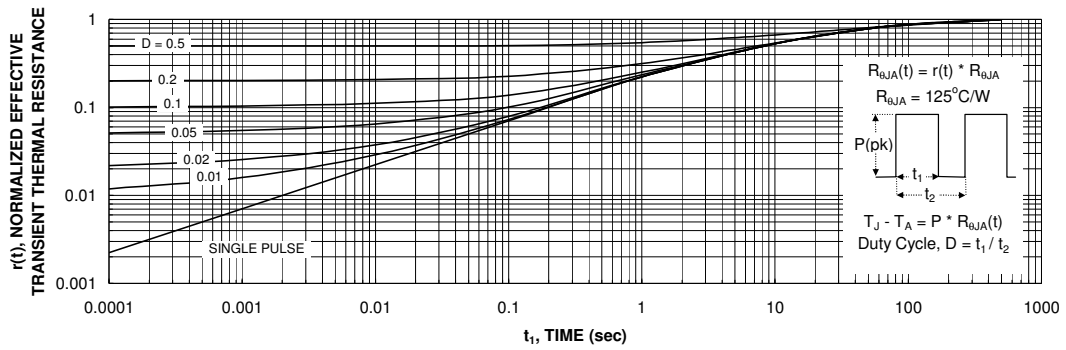

Figure 12. Transient Thermal Response Curve.

Thermal characterization performed using the conditions described in Note 1c.
 Transient thermal response will change depending on the circuit board design.

PSPICE Electrical Model N-Channel

.SUBCKT FDS6612A 2 1 3
 *NOM TEMP=25 DEG C
 *REV A - JULY 2003

CA 12 8 1E-9
 CB 15 14 4.0E-10
 CIN 6 8 5.1E-10

DBODY 7 5 DBODYMOD
 DBREAK 5 11 DBREAKMOD
 DPLCAP 10 5 DPLCAPMOD

EBREAK 11 7 17 18 34.2
 EDS 14 8 5 8 1
 EGS 13 8 6 8 1
 ESG 6 10 6 8 1
 EVTHRES 6 21 19 8 1
 EVTEMP 20 6 18 22 1

IT 8 17 1

LGATE 1 9 3.84E-9
 LDRAIN 2 5 1.00E-9
 LSOURCE 3 7 4E-9

RLGATE 1 9 38.4
 RLDRAIN 2 5 10
 RLSOURCE 3 7 40

MMED 16 6 8 8 MMEDMOD
 MSTRO 16 6 8 8 MSTROMOD
 MWEAK 16 21 8 8 MWEAKMOD

RBREAK 17 18 RBREAKMOD 1
 RDRAIN 50 16 RDRAINMOD 8E-3
 RGATE 9 20 4.2

RSLC1 5 51 RSLCMOD 1E-6
 RSLC2 5 50 1E3
 RSOURCE 8 7 RSOURCEMOD 7.5E-3
 RVTHRES 22 8 RVTHRESMOD 1
 RVTEMP 18 19 RVTEMPMOD 1

S1A 6 12 13 8 S1AMOD
 S1B 13 12 13 8 S1BMOD
 S2A 6 15 14 13 S2AMOD
 S2B 13 15 14 13 S2BMOD

VBAT 22 19 DC 1

ESLC 51 50 VALUE=((V(5,51)/ABS(V(5,51))))*(PWR(V(5,51)/(1E-6*105),3))

.MODEL DBODYMOD D (IS=7E-15 RS=6.1E-3 N=0.84 TRS1=1.7E-3 TRS2=1.0E-6
 + CJO=3.2E-10 TT=10E-9 M=0.5 IKF=0.3 XTI=3.0)
 .MODEL DBREAKMOD D (RS=1E-1 TRS1=1.12E-3 TRS2=1.25E-6)
 .MODEL DPLCAPMOD D (CJO=14E-11 IS=1E-30 N=10 M=0.34)
 .MODEL MWEAKMOD NMOS (VTO=1.82 KP=0.05 IS=1E-30 N=10 TOX=1 L=1U W=1U RG=42 RS=.1)
 .MODEL MMEDMOD NMOS (VTO=2.1 KP=6 IS=1E-30 N=10 TOX=1 L=1U W=1U RG=4.2)
 .MODEL MSTROMOD NMOS (VTO=2.55 KP=50 IS=1E-30 N=10 TOX=1 L=1U W=1U)
 .MODEL RBREAKMOD RES (TC1=0.83E-3 TC2=1E-7)
 .MODEL RDRAINMOD RES (TC1=6E-3 TC2=5E-6)
 .MODEL RSLCMOD RES (TC1=2.5E-3 TC2=4.5E-6)
 .MODEL RSOURCEMOD RES (TC1=1.0E-3 TC2=1E-6)
 .MODEL RVTHRESMOD RES (TC1=-2.013E-3 TC2=-7E-6)
 .MODEL RVTEMPMOD RES (TC1=-1.5E-3 TC2=1E-6)
 .MODEL S1AMOD VSWITCH (RON=1E-5 ROFF=0.1 VON=-4 VOFF=-3)
 .MODEL S1BMOD VSWITCH (RON=1E-5 ROFF=0.1 VON=-3 VOFF=-4)
 .MODEL S2AMOD VSWITCH (RON=1E-5 ROFF=0.1 VON=-1.3 VOFF=-0.5)
 .MODEL S2BMOD VSWITCH (RON=1E-5 ROFF=0.1 VON=-0.5 VOFF=-1.3)

.ENDS

Note: For further discussion of the PSPICE model, consult **A New PSPICE Sub-Circuit for the Power MOSFET Featuring Global Temperature Options**; IEEE Power Electronics Specialist Conference Records, 1991, written by William J. Hepp and C. Frank Wheatley.

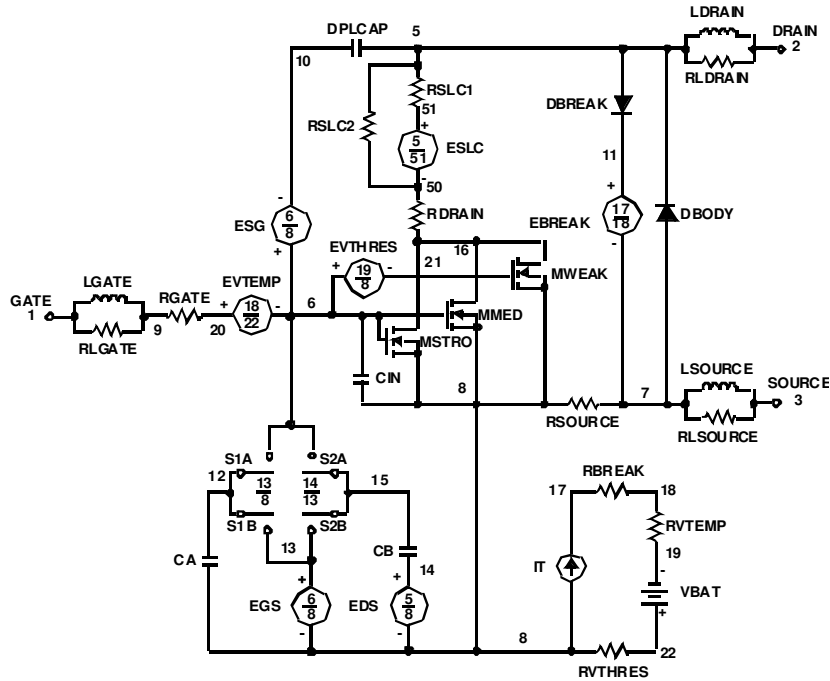

SPICE Thermal Model

```
.SUBCKT FDS6612A_THERM TH TL
*THERMAL MODEL SUBCIRCUIT
*REV A - JULY 2003
*MIN PAD RJA
```

CTHERM1	TH	8	0.005
CTHERM2	8	7	0.05
CTHERM3	7	6	0.10
CTHERM4	6	5	0.35
CTHERM5	5	4	0.45
CTHERM6	4	3	0.50
CTHERM7	3	2	0.55
CTHERM8	2	TL	3.00
RTHERM1	TH	8	5.000
RTHERM2	8	7	6.250
RTHERM3	7	6	7.500
RTHERM4	6	5	8.750
RTHERM5	5	4	10.625
RTHERM6	4	3	11.875
RTHERM7	3	2	31.250
RTHERM8	2	TL	43.750

```
.ENDS
```

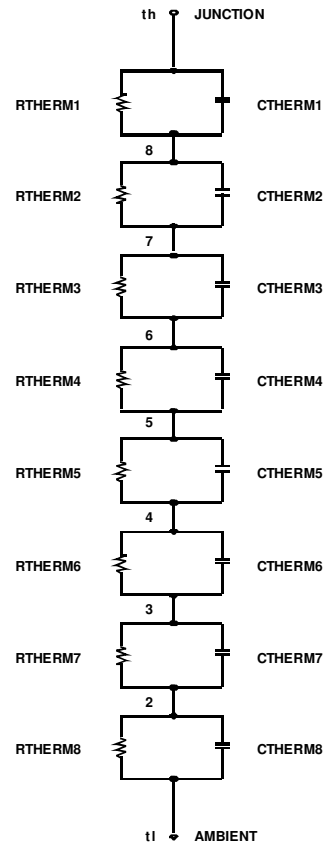



TRADEMARKS

The following are registered and unregistered trademarks Fairchild Semiconductor owns or is authorized to use and is not intended to be an exhaustive list of all such trademarks.

ACEx®	<i>i-Lo</i> ™	Power-SPM™	TinyBoost™
Across the board. Around the world™	ImpliedDisconnect™	PowerTrench®	TinyBuck™
ActiveArray™	IntelliMAX™	Programmable Active Droop™	TinyLogic®
Bottomless™	ISOPLANAR™	QFET®	TINYOPTO™
Build it Now™	MICROCOUPLER™	QS™	TinyPower™
CoolFET™	MicroPak™	QT Optoelectronics™	TinyWire™
CROSSVOLT™	MICROWIRE™	Quiet Series™	TruTranslation™
CTL™	Motion-SPM™	RapidConfigure™	µSerDes™
Current Transfer Logic™	MSX™	RapidConnect™	UHC®
DOME™	MSXPro™	ScalarPump™	UniFET™
E ² CMOS™	OCX™	SMART START™	VCX™
EcoSPARK®	OCXPro™	SPM®	Wire™
EnSigna™	OPTOLOGIC®	STEALTH™	
FACT Quiet Series™	OPTOPLANAR®	SuperFET™	
FACT®	PACMAN™	SuperSOT™-3	
FAST®	PDP-SPM™	SuperSOT™-6	
FAST _r ™	POP™	SuperSOT™-8	
FPS™	Power220®	SyncFET™	
FRFET®	Power247®	TCM™	
GlobalOptoisolator™	PowerEdge™	The Power Franchise®	
GTO™	PowerSaver™	 ™	
HiSeC™			

DISCLAIMER

FAIRCHILD SEMICONDUCTOR RESERVES THE RIGHT TO MAKE CHANGES WITHOUT FURTHER NOTICE TO ANY PRODUCTS HEREIN TO IMPROVE RELIABILITY, FUNCTION OR DESIGN. FAIRCHILD DOES NOT ASSUME ANY LIABILITY ARISING OUT OF THE APPLICATION OR USE OF ANY PRODUCT OR CIRCUIT DESCRIBED HEREIN; NEITHER DOES IT CONVEY ANY LICENSE UNDER ITS PATENT RIGHTS, NOR THE RIGHTS OF OTHERS. THESE SPECIFICATIONS DO NOT EXPAND THE TERMS OF FAIRCHILD'S WORLDWIDE TERMS AND CONDITIONS, SPECIFICALLY THE WARRANTY THEREIN, WHICH COVERS THESE PRODUCTS.

LIFE SUPPORT POLICY

FAIRCHILD'S PRODUCTS ARE NOT AUTHORIZED FOR USE AS CRITICAL COMPONENTS IN LIFE SUPPORT DEVICES OR SYSTEMS WITHOUT THE EXPRESS WRITTEN APPROVAL OF FAIRCHILD SEMICONDUCTOR CORPORATION.

As used herein:

- Life support devices or systems are devices or systems which, (a) are intended for surgical implant into the body or (b) support or sustain life, and (c) whose failure to perform when properly used in accordance with instructions for use provided in the labeling, can be reasonably expected to result in a significant injury of the user.
- A critical component in any component of a life support device, or system whose failure to perform can be reasonably expected to cause the failure of the life support device or system, or to affect its safety or effectiveness.

PRODUCT STATUS DEFINITIONS

Definition of Terms

Datasheet Identification	Product Status	Definition
Advance Information	Formative or In Design	This datasheet contains the design specifications for product development. Specifications may change in any manner without notice.
Preliminary	First Production	This datasheet contains preliminary data; supplementary data will be published at a later date. Fairchild Semiconductor reserves the right to make changes at any time without notice to improve design.
No Identification Needed	Full Production	This datasheet contains final specifications. Fairchild Semiconductor reserves the right to make changes at any time without notice to improve design.
Obsolete	Not In Production	This datasheet contains specifications on a product that has been discontinued by Fairchild Semiconductor. The datasheet is printed for reference information only.

ON Semiconductor and  are trademarks of Semiconductor Components Industries, LLC dba ON Semiconductor or its subsidiaries in the United States and/or other countries. ON Semiconductor owns the rights to a number of patents, trademarks, copyrights, trade secrets, and other intellectual property. A listing of ON Semiconductor's product/patent coverage may be accessed at www.onsemi.com/site/pdf/Patent-Marking.pdf. ON Semiconductor reserves the right to make changes without further notice to any products herein. ON Semiconductor makes no warranty, representation or guarantee regarding the suitability of its products for any particular purpose, nor does ON Semiconductor assume any liability arising out of the application or use of any product or circuit, and specifically disclaims any and all liability, including without limitation special, consequential or incidental damages. Buyer is responsible for its products and applications using ON Semiconductor products, including compliance with all laws, regulations and safety requirements or standards, regardless of any support or applications information provided by ON Semiconductor. "Typical" parameters which may be provided in ON Semiconductor data sheets and/or specifications can and do vary in different applications and actual performance may vary over time. All operating parameters, including "Typicals" must be validated for each customer application by customer's technical experts. ON Semiconductor does not convey any license under its patent rights nor the rights of others. ON Semiconductor products are not designed, intended, or authorized for use as a critical component in life support systems or any FDA Class 3 medical devices or medical devices with a same or similar classification in a foreign jurisdiction or any devices intended for implantation in the human body. Should Buyer purchase or use ON Semiconductor products for any such unintended or unauthorized application, Buyer shall indemnify and hold ON Semiconductor and its officers, employees, subsidiaries, affiliates, and distributors harmless against all claims, costs, damages, and expenses, and reasonable attorney fees arising out of, directly or indirectly, any claim of personal injury or death associated with such unintended or unauthorized use, even if such claim alleges that ON Semiconductor was negligent regarding the design or manufacture of the part. ON Semiconductor is an Equal Opportunity/Affirmative Action Employer. This literature is subject to all applicable copyright laws and is not for resale in any manner.

PUBLICATION ORDERING INFORMATION

LITERATURE FULFILLMENT:

Literature Distribution Center for ON Semiconductor
19521 E. 32nd Pkwy, Aurora, Colorado 80011 USA
Phone: 303-675-2175 or 800-344-3860 Toll Free USA/Canada
Fax: 303-675-2176 or 800-344-3867 Toll Free USA/Canada
Email: orderlit@onsemi.com

N. American Technical Support: 800-282-9855 Toll Free
USA/Canada
Europe, Middle East and Africa Technical Support:
Phone: 421 33 790 2910
Japan Customer Focus Center
Phone: 81-3-5817-1050

ON Semiconductor Website: www.onsemi.com
Order Literature: <http://www.onsemi.com/orderlit>
For additional information, please contact your local
Sales Representative