



Chipsmall Limited consists of a professional team with an average of over 10 year of expertise in the distribution of electronic components. Based in Hongkong, we have already established firm and mutual-benefit business relationships with customers from,Europe,America and south Asia,supplying obsolete and hard-to-find components to meet their specific needs.

With the principle of “Quality Parts,Customers Priority,Honest Operation,and Considerate Service”,our business mainly focus on the distribution of electronic components. Line cards we deal with include Microchip,ALPS,ROHM,Xilinx,Pulse,ON,Everlight and Freescale. Main products comprise IC,Modules,Potentiometer,IC Socket,Relay,Connector.Our parts cover such applications as commercial,industrial, and automotives areas.

We are looking forward to setting up business relationship with you and hope to provide you with the best service and solution. Let us make a better world for our industry!



Contact us

Tel: +86-755-8981 8866 Fax: +86-755-8427 6832

Email & Skype: info@chipsmall.com Web: www.chipsmall.com

Address: A1208, Overseas Decoration Building, #122 Zhenhua RD., Futian, Shenzhen, China



FEB167-002 User Guide
FAN2106
TinyBuck™ Integrated Synchronous Buck
Evaluation Board

Featured Fairchild Product: FAN2106

www.fairchildsemi.com/FEBsupport

Table of Contents

1. Overview.....	3
2. Board Configuration	3
3. Power-Up Sequence.....	3
4. Board Features	4
4.1. Switching Waveform	4
4.2. Enable / Inhibit.....	4
4.3. Current Limit	4
4.4. Auto-Restart.....	4
4.5. Switching Frequency.....	4
4.6. Output Voltage.....	4
4.7. Feedback Loop Response.....	4
5. Schematics	5
6. Bill of Materials	5
7. Assembly Diagram.....	7
8. PCB Layout.....	7

This guide supports the evaluation kit for the [FAN2106](#) TinyBuck™ Integrated Synchronous Buck. This guide should be used in conjunction with the FAN2106 datasheet, located at Fairchild's website ([www.fairchildsemi.com](#)).

1. Overview

This board provides 1.8V_{OUT} and 0-6A from 8-20V_{IN} at a 500KHz switching rate using low-cost ceramic output capacitors.

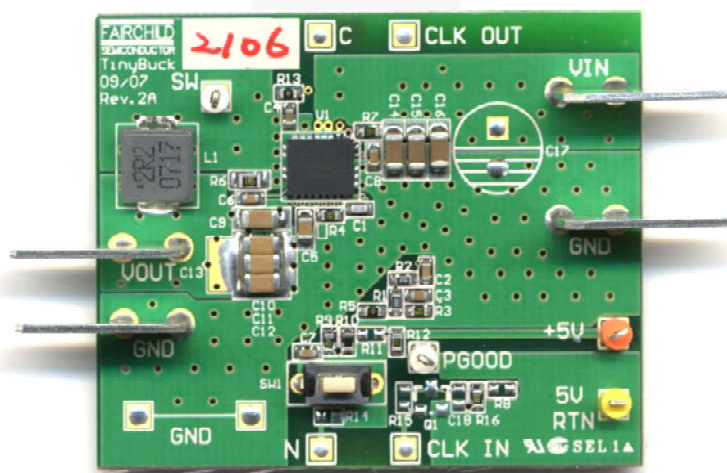

Figure 1. Evaluation Board and Required Connections

2. Board Configuration

- Output Voltage: 1.8V
- Output Current: 0-6A
- Input Voltage: 8-20V
- Frequency: 500KHz

3. Power-Up Sequence

1. Establish connections to test equipment as shown in the schematic in Figure 2. Use suitable diameter wires and connectors to avoid excessive voltage drop or temperature rise.

Do not turn on power supplies until all the connections are complete.

2. Verify voltage sources have current limits adequately set to supply the load.
3. Apply V_{IN} before V_{CC} to avoid skipping the soft-start cycle.
4. Apply the desired load current.

This can be done at any time, including before power-up, but it is recommended to power-up the first time with 0A load to verify proper connections.

To power down, turn off the V_{CC} (5V) supply first.

4. Board Features

Facility to make a ground strap is provided near the lower-left corner of the evaluation board to facilitate oscilloscope probe connections.

4.1. Switching Waveform

Connect an oscilloscope probe to test point marked SW to view the switching waveform. Since the MOSFETs are integrated, gate/drive waveforms cannot be viewed.

4.2. Enable / Inhibit

The momentary push-button switch S1 establishes a connection from EN to GND, inhibiting the FAN2106 when switching ceases and only standby current flows at V_{IN} and V_{CC} .

A new soft-start cycle commences upon release of S1.

4.3. Current Limit

The current limit threshold can be set lower by reducing R9. This feature is useful in applications where $<6A$ is required, allowing the designer to select passive external components with lower current ratings.

With R9 open, the FAN2106 enforces a maximum default current limit in excess of 6A.

4.4. Auto-Restart

The board is configured for auto-restart with a delay (C7) that increases linearly with C7.

Refer to the datasheet for auto-restart or latch-off options.

4.5. Switching Frequency

Switching frequency is set by R10 (R_T). Frequency may be lowered to 200KHz or raised to $>600KHz$.

Large changes in frequency may warrant additional component value changes for the output filter and compensation network.

4.6. Output Voltage

The output voltage is determined by the ratio of R1 and R4. For minor output voltage changes, adjust R4.

Larger V_{OUT} changes may impact output filter and compensation network component value selection.

4.7. Feedback Loop Response

R5 opens the feedback loop for closed-loop response measurement. Remove R5 and connect a network analyzer or injection transformer in its place.

5. Schematics

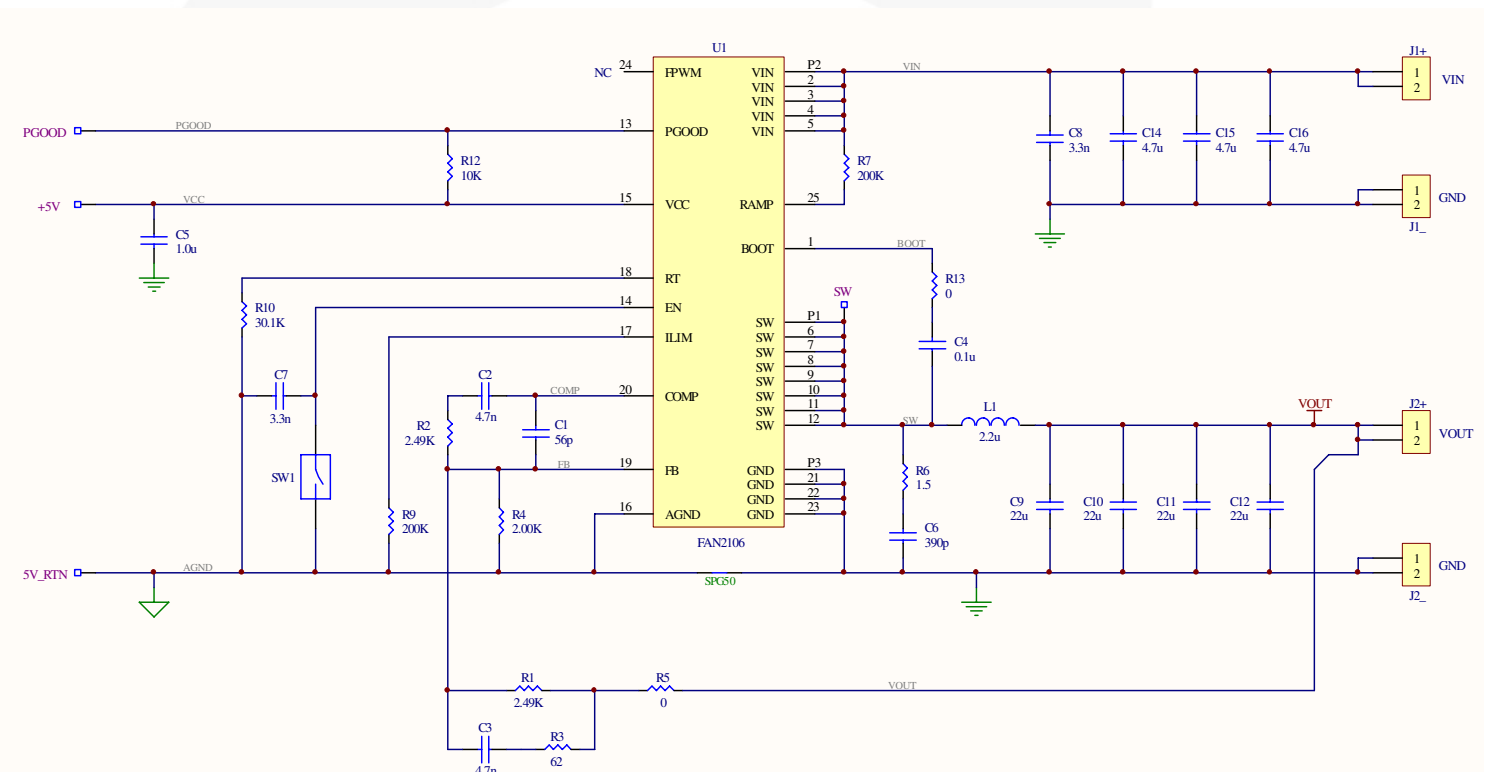

Figure 2. FAN2106 Evaluation Board Schematic

6. Bill of Materials

Reference Designator	QTY	Description	Manufacturer / Number
U1	1	IC, FAN2106, MLP5x6	Fairchild FAN2106M
L1	1	2.2μH, 8A, 10.4mΩ	Inter-Technical SC72332-2R2M
R1, 2	2	2.49K, 1%, 0603	Generic
R3	1	62Ω, 5%, 0603	Generic
R4	1	2.00K, 1%, 0603	Generic
R5, 13	3	0Ω, 5%, 0603	Generic
R6	1	1.5Ω, 5%, 0805	Generic
R7, 9	2	200kΩ, 1%, 0603	Generic
R10	1	30.1kΩ, 1%, 0603	Generic
R12	1	10kΩ, 5%, 0603	Generic
C1	1	56pf, 50V, 5%, NPO, 0603	Generic
C2, 3	2	4.7nf, 50V, 10%, X7R, 0603	Generic
C7, 8	2	3.3nf, 50V, 10%, X7R, 0603	Generic
C4	1	0.1μf, 16V, 10%, X7R, 0603	Generic
C5	1	1.0μf, 10V, 10%, X5R, 0805	Generic
C6	1	390pf, 50V, 5%, X7R, 0603	Generic
C9, 10, 11, 12	4	22μf, 6.3V, 20%, X5R, 1206	Generic
C14, 15, 16	3	4.7μf, 25V, 20%, X5R, 1206	Generic
C18	5	No Load 0603	
R8, R11, R14, R15, R16, R17			
C13			
C17			
C19			
Q1	1	No Load SOT23	

7. Assembly Diagram

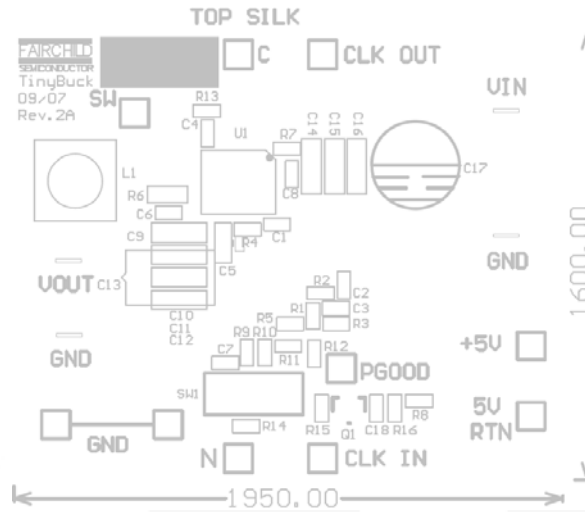

Figure 3. Assembly Diagram

8. PCB Layout

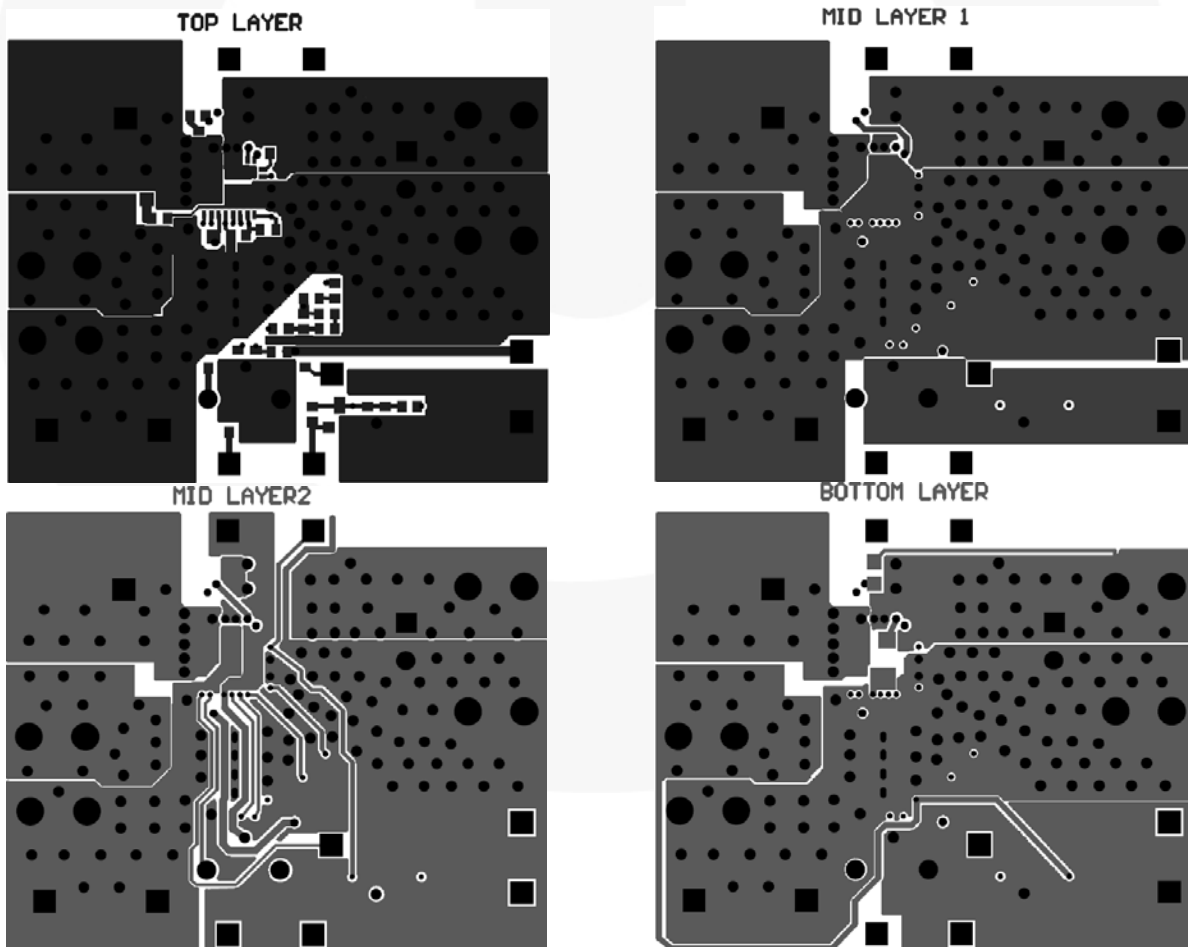





Figure 4. PCB Layout

TRADEMARKS

The following are registered and unregistered trademarks Fairchild Semiconductor owns or is authorized to use and is not intended to be an exhaustive list of all such trademarks.

ACEx®	FPS™	PDP SPM™	The Power Franchise®
Build it Now™	F-PFS™	Power-SPM™	
CorePLUS™	FRFET®	PowerTrench®	TinyBoost™
CorePOWER™	Global Power Resource™	Programmable Active Droop™	TinyBuck™
CROSSVOLT™	Green FPS™	QFET®	TinyLogic®
CTL™	Green FPS™ e-Series™	QS™	Quiet Series™
Current Transfer Logic™	GTO™	Quiet Series™	RapidConfigure™
EcoSPARK®	IntelliMAX™	RapidConfigure™	Saving our world, 1mW at a time™
EfficientMax™	ISOPLANAR™	SmartMax™	SMART START™
EZSWITCH™ *	MegaBuck™	SMART START™	SPM®
	MICROCOUPLER™	SPM®	STEALTH™
	MicroFET™	SPM®	SuperFET™
Fairchild®	MicroPak™	STEALTH™	SuperSOT™-3
Fairchild Semiconductor®	MillerDrive™	SuperFET™	SuperSOT™-6
FACT Quiet Series™	MotionMax™	SuperSOT™-3	SuperSOT™-8
FACT®	Motion-SPM™	SuperSOT™-6	SupreMOS™
FAST®	OPTOLOGIC®	SuperSOT™-8	SyncFET™
FastvCore™	OPTOPLANAR®	SupreMOS™	SYSTEM®
FlashWriter® *		SyncFET™	GENERAL
		SYSTEM®	
		GENERAL	

WARNING AND DISCLAIMER

Replace components on the Evaluation Board only with those parts shown on the parts list (or Bill of Materials) in the Users' Guide. Contact an authorized Fairchild representative with any questions.

The Evaluation board (or kit) is for demonstration purposes only and neither the Board nor this User's Guide constitute a sales contract or create any kind of warranty, whether express or implied, as to the applications or products involved. Fairchild warrants that its products meet Fairchild's published specifications, but does not guarantee that its products work in any specific application. Fairchild reserves the right to make changes without notice to any products described herein to improve reliability, function, or design. Either the applicable sales contract signed by Fairchild and Buyer or, if no contract exists, Fairchild's standard Terms and Conditions on the back of Fairchild invoices, govern the terms of sale of the products described herein.

DISCLAIMER

FAIRCHILD SEMICONDUCTOR RESERVES THE RIGHT TO MAKE CHANGES WITHOUT FURTHER NOTICE TO ANY PRODUCTS HEREIN TO IMPROVE RELIABILITY, FUNCTION, OR DESIGN. FAIRCHILD DOES NOT ASSUME ANY LIABILITY ARISING OUT OF THE APPLICATION OR USE OF ANY PRODUCT OR CIRCUIT DESCRIBED HEREIN; NEITHER DOES IT CONVEY ANY LICENSE UNDER ITS PATENT RIGHTS, NOR THE RIGHTS OF OTHERS.

LIFE SUPPORT POLICY

FAIRCHILD'S PRODUCTS ARE NOT AUTHORIZED FOR USE AS CRITICAL COMPONENTS IN LIFE SUPPORT DEVICES OR SYSTEMS WITHOUT THE EXPRESS WRITTEN APPROVAL OF THE PRESIDENT OF FAIRCHILD SEMICONDUCTOR CORPORATION.

As used herein:

1. Life support devices or systems are devices or systems which, (a) are intended for surgical implant into the body, or (b) support or sustain life, or (c) whose failure to perform when properly used in accordance with instructions for use provided in the labeling, can be reasonably expected to result in significant injury to the user.
2. A critical component is any component of a life support device or system whose failure to perform can be reasonably expected to cause the failure of the life support device or system, or to affect its safety or effectiveness.