



Chipsmall Limited consists of a professional team with an average of over 10 year of expertise in the distribution of electronic components. Based in Hongkong, we have already established firm and mutual-benefit business relationships with customers from,Europe,America and south Asia,supplying obsolete and hard-to-find components to meet their specific needs.

With the principle of “Quality Parts,Customers Priority,Honest Operation,and Considerate Service”,our business mainly focus on the distribution of electronic components. Line cards we deal with include Microchip,ALPS,ROHM,Xilinx,Pulse,ON,Everlight and Freescale. Main products comprise IC,Modules,Potentiometer,IC Socket,Relay,Connector.Our parts cover such applications as commercial,industrial, and automotives areas.

We are looking forward to setting up business relationship with you and hope to provide you with the best service and solution. Let us make a better world for our industry!



Contact us

Tel: +86-755-8981 8866 Fax: +86-755-8427 6832

Email & Skype: info@chipsmall.com Web: www.chipsmall.com

Address: A1208, Overseas Decoration Building, #122 Zhenhua RD., Futian, Shenzhen, China



User Guide for
FEBFL7701_L30U003A

2.4 W LED Ballast Using FL7701

**Featured Fairchild Product:
FL7701**

*Direct questions or comments
about this evaluation board to:
“Worldwide Direct Support”*

Fairchild Semiconductor.com

Table of Contents

1. Introduction.....	3
1.1. General Description.....	3
1.2. Key Features.....	3
1.3. Internal Block Diagram.....	4
2. General Specifications for Evaluation Board	5
3. Photographs of the Evaluation Board	6
4. Printed Circuit Board	7
5. Schematic	8
6. Bill of Materials	8
7. Performance of Evaluation Board.....	9
7.1. Typical Waveforms: Startup	10
7.2. Operating Frequency & Minimum Duty	11
7.3. Typical Waveforms: Steady State	12
7.4. Typical Waveforms: Abnormal Mode (LED Open)	15
7.5. Typical Waveforms: Abnormal Mode (Inductor Short Condition)	16
7.6. Power Factor (PF) at Rated Load Condition.....	17
7.7. Total Harmonic Discharge (THD) Performance	18
7.8. System Efficiency	19
7.9. Thermal Performance.....	20
7.10. Electromagnetic Interference (EMI) Results.....	22
8. Revision History	24

This FEBFL7701_L30U003A Evaluation Board can be identified by the silkscreen marking FL7701 Board on the top side of the PCB. This user guide supports the evaluation board for the FL7701, FEBFL7701_L30U003A. It should be used in conjunction with the FL7701 datasheet as well as Fairchild's application notes and technical support team. Please visit Fairchild's website at www.fairchildsemi.com or the evaluation board page <http://www.fairchildsemi.com/products/evaluationboards/>.

1. Introduction

This document describes the proposed solution for a universal-input 2.4W LED ballast using the FL7701. The input voltage range is $90 V_{RMS} - 265 V_{RMS}$ and there is one DC output with a constant current of 85 mA at $28 V_{MAX}$. This document contains general description of FL7701, the power supply specification, schematic, bill of materials, and the typical operating characteristics.

1.1. General Description

The FL7701 LED lamp driver is a simple IC with PFC function. The special “adopted digital” technique automatically detects input voltage condition and sends an internal reference signal, resulting in high power factor. When an AC input voltage is applied to the IC, the PFC function is automatically enabled. Otherwise, when a DC input is applied to the IC, the PFC function is automatically disabled. The FL7701 does not require a bulk capacitor (electrolytic capacitor) for supply rail stability, which can significantly affect LED reliability.

1.2. Key Features

- Digitally Implemented Active PFC Function
- Built-in Self-Biasing HV Startup Circuit
- Application Input Range: $80 V_{AC} \sim 308 V_{AC}$
- AOCV Function with Auto-Restart Mode
- Built-in Over-Temperature Protection
- Cycle-by-Cycle Current Limit
- Current-Sense Pin Open Protection
- Low Operating Current: 0.85 mA (Typical)
- Under-Voltage Lockout with 5 V Hysteresis
- Programmable Oscillator Frequency
- Programmable LED Current
- Analog Dimming Function
- Fixed Soft-Start Function
- Precise Internal Reference: $\pm 3\%$

1.3. Internal Block Diagram

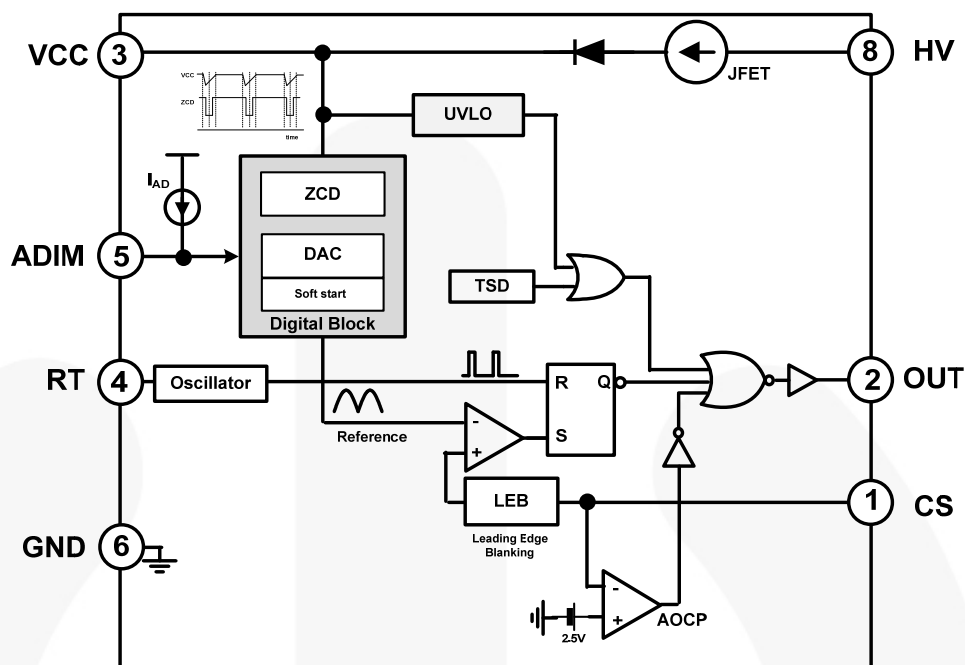

Figure 1. Internal Block Diagram

Pin Descriptions

Pin	Symbol	Description
1	CS	Current Sense. Limits output current, depending on the sensing resistor voltage. The CS pin is also used to set the LED current regulation.
2	OUT	Output. Connects to the MOSFET gate.
3	VCC	Supply Voltage. Supply pin for stable IC operation; ZCD signal detection used for accurate PFC function.
4	RT	Resistor. Programmable operating frequency using an external resistor connected to this PIN and the IC has fixed frequency when this pin is left open or floating.
5	ADIM	Analog Dimming. Connects to the internal current source and can change the output current using an external resistor. If ADIM is not used, connect a 0.1 μ F bypass capacitor between ADIM and GND.
6	GND	GROUND. Ground for the IC.
7	NC	No Connection
8	HV	High Voltage. Connect to the high-voltage line and supply current to the IC

2. General Specifications for Evaluation Board

All data for this table was measured at an ambient temperature of 25°C

Table 1. Summary of Features and Performance

Description	Symbol	Value	Comments
Input Voltage Range	$V_{IN,min}$	90 V	
	$V_{IN,nom}$	220 V	
	$V_{IN,max}$	265 V	
AC Input Frequency	$f_{IN,min}$	47 Hz	
	$f_{IN,max}$	64 Hz	
Output Voltage/Current	V_{OUT}	28 V	Note 1
	I_{OUT}	85 mA	
Output Power	Output Power	2.41 W	Note 2
Efficiency		> 75%	At full load
Temperature	T_{FL7701}	< 71.5°C	At full load (all at open frame, room temperature / still air)
	T_{MOSFET}	< 59.5°C	
	$T_{INDUCTOR}$	< 57.7°C	
PCB Size		20 mm (width) x 32 mm (length) x 13 mm (height)	
Initial Application		LED bulb	

Notes:

- The output current has I_{LEDPK} ripple. To reduce ripple current, use a large electrolytic capacitor in parallel with the LED. Ensure the capacitor voltage rating is high enough to withstand an open-LED condition or use a Zener diode for protection.
- The output power is not equal to the apparent power due to the slight phase shift between the output voltage and current.

3. Photographs of the Evaluation Board

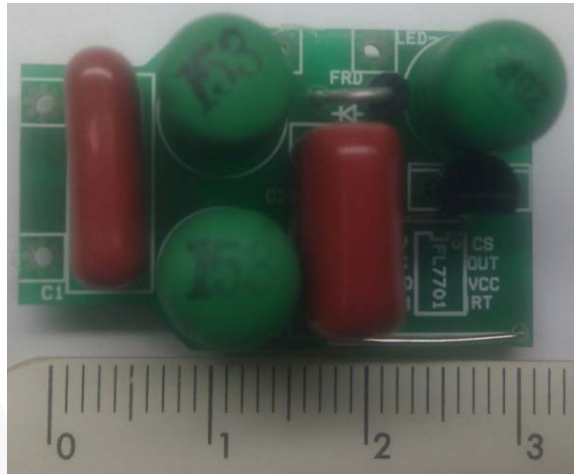

Figure 2. Photograph Top View (20 mm x 32 mm x 13 mm)

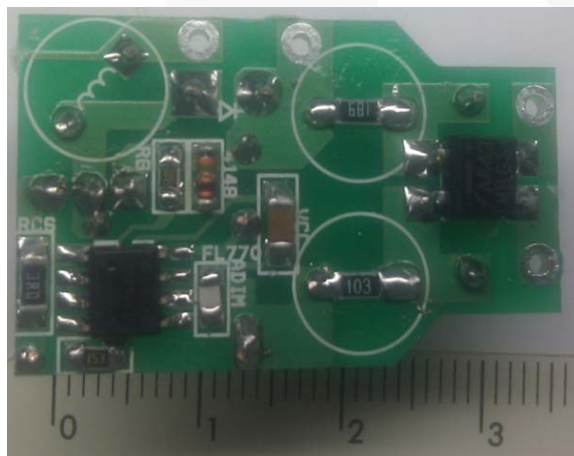

Figure 3. Photograph Bottom View (20 mm x 32 mm x 13 mm)



Figure 4. Photograph Side View (20 mm x 32 mm x 13 mm)

4. Printed Circuit Board

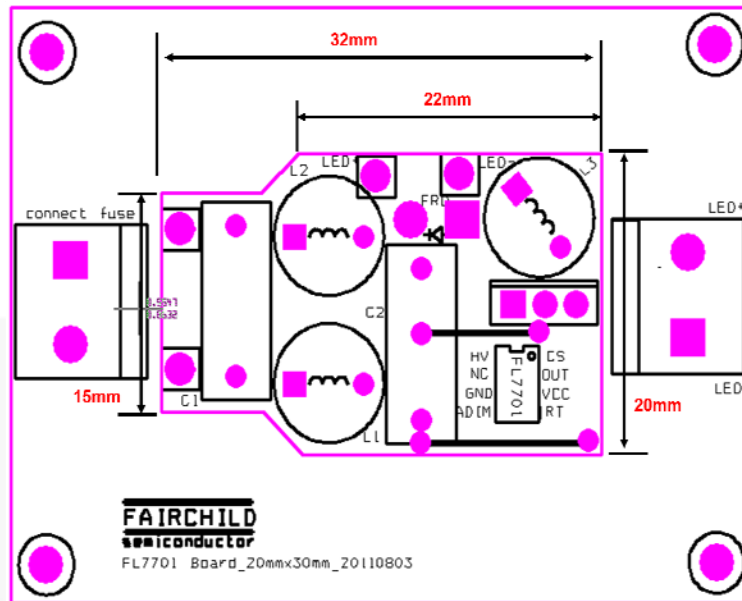

Figure 5. PCB, Top Side

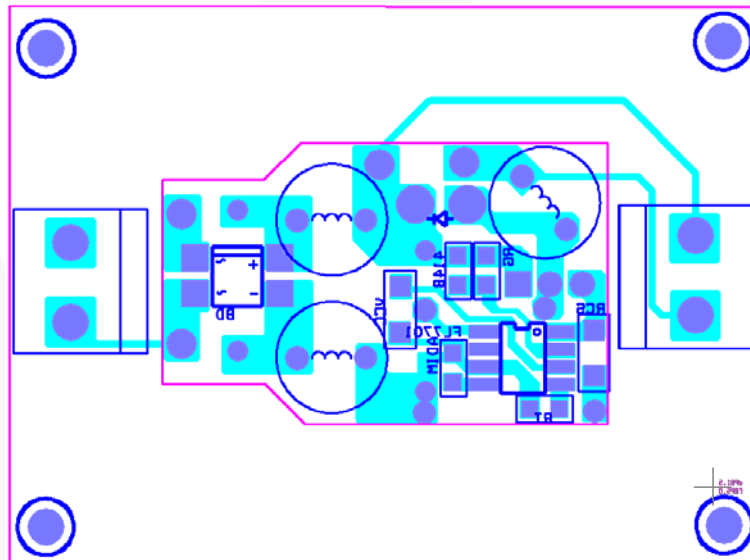

Figure 6. PCB, Bottom Side

5. Schematic

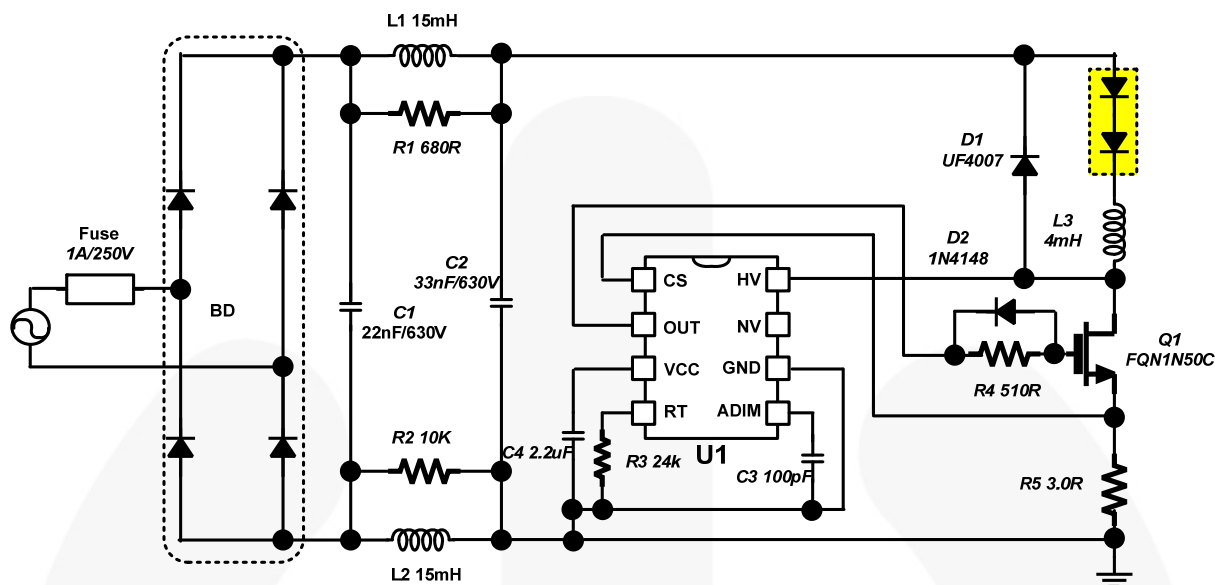

Figure 7. Schematic of Evaluation

6. Bill of Materials

Item No.	Part Reference	Part Number	Qty.	Description	Manufacturer
1	U1	FL7701	1	Main Controller	Fairchild Semiconductor
2	BD	MB6S	1	0.5 A / 600 V Bridge Diode	Fairchild Semiconductor
3	C1	MPE 630V223K	1	22 nF / 630 V _{AC} 10%, Polypropylene	SungHo
4	C2	MPE 630V333K	1	33 nF / 630 V _{AC} 10%, Polypropylene	SungHo
5	C3	C0805C101K3RACTU	1	100 pF / 25 V SMD Capacitor 2012	Kemet
6	C4	C1206C225K3PACTU	1	2.2 μF / 25 V SMD Capacitor 3216	Kemet
7	D1	UF4007	1	1 A / 1 kV Ultra Fast Recovery	Fairchild Semiconductor
8	D2	1N4148	1	1 A / 100 V Small Signal Diode	Fairchild Semiconductor
9	L1, L2	R06153KT00	2	1.5 mH Radial Inductor R6.5x7.5	Bosung
10	L3	R06402KT00	1	4 mH Radial Inductor R6.5x7.5	Bosung
11	R1	RC1206JR-07680RL	1	680Ω SMD Resistor 3216	Yageo
12	R2	RC1206JR-0710KL	1	10kΩ SMD Resistor 3216	Yageo
13	R3	RC0805JR-0724KL	1	24kΩ SMD Resistor 2012	Yageo
14	R4	RC0805JR-07510RL	1	510Ω SMD Resistor 2012	Yageo
15	R5	RC1206JR-073RL	1	3Ω SMD Resistor 3216	Yageo

7. Performance of Evaluation Board

Table 2. Test Condition & Equipments

Test Temperature	T _A = 25°C
Test Equipments	AC Source: PCR500L by Kikusui Power Meter: PZ4000 by Yokogawa Oscilloscope: Waverunner 64Xi by Lecroy EMI Test Receiver: ESCS30 by ROHDE & SCHWARZ Two-Line V-Network: ENV216 by ROHDE & SCHWARZ Thermometer: CAM SC640 by FLIR SYSTEMS LED: EHP-AX08EL/GT01H-P03 (3W) by Everlight

7.2. Operating Frequency & Minimum Duty

The programmable switching frequency is between 20 kHz ~ 250 kHz, determined by selecting the RT resistor value. If no RT resistor is used (RT pin OPEN), the FL7701 default switching frequency is set to 45 kHz. The maximum duty ratio is fixed below 50% and has a fixed minimum typical on-time of 400 ns. There are two crucial points to design properly. The first is consideration of the minimum duty ratio at minimum input voltage because the FL7701 is limited to 50% duty ratio. The second consideration is minimum on-time at maximum input voltage condition. The FL7701 cannot control output power when the operating conditions are such that the required on-time is less than the 400 ns minimum on-time.

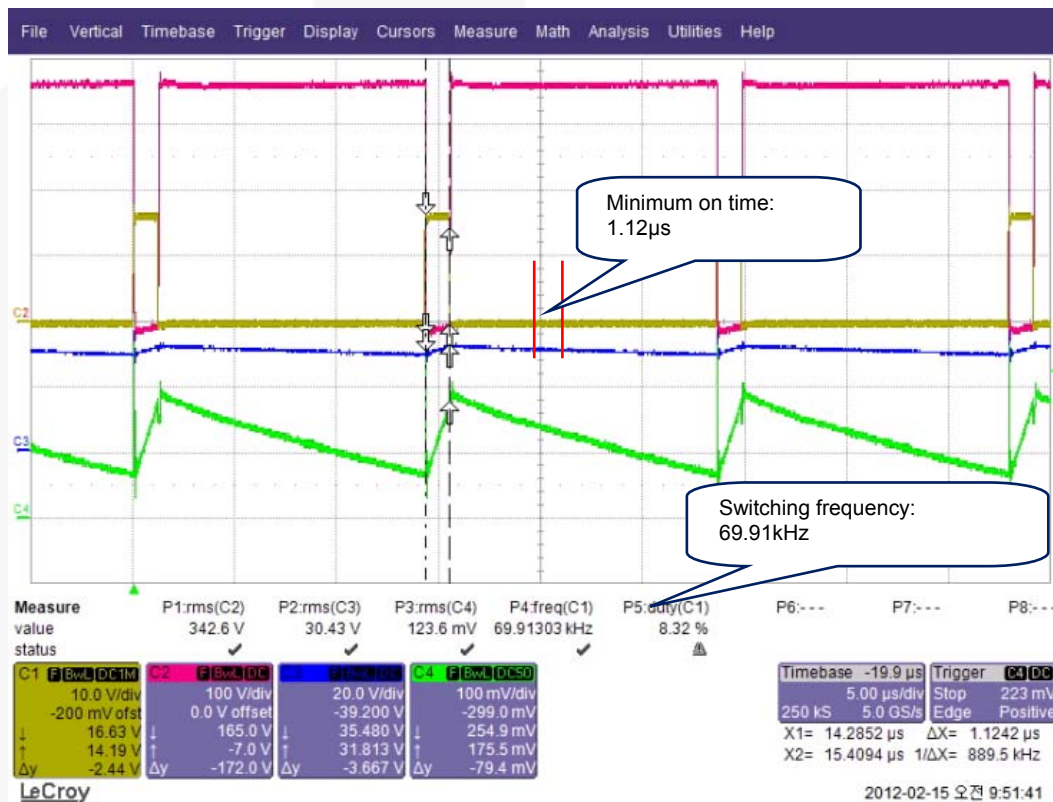

CH1: V_{CC}, CH2: V_{DRAIN}, CH3: V_{LED}, CH4: I_{LED}
Figure 12. Operating Frequency & Minimum Duty

7.3. Typical Waveforms: Steady State

Figure 13 through Figure 22 show the normal operation waveform by input voltage & input frequency. The output voltage and current maintains a certain output level with 120 Hz ripple, as shown in the test results in Table 3.

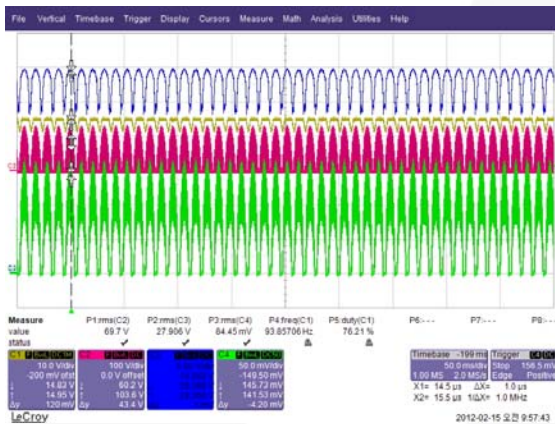

CH1: V_{CC}, CH2: V_{DRAIN}, CH3: V_{LED}, CH4: I_{LED}

Figure 13. Input Voltage: 90 V_{AC}, Input Frequency: 47 Hz

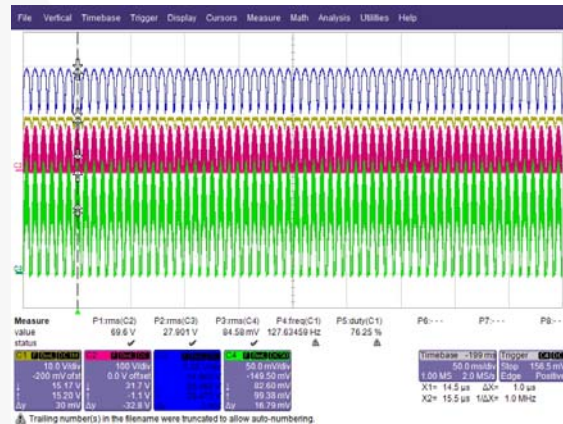

CH1: V_{CC}, CH2: V_{DRAIN}, CH3: V_{LED}, CH4: I_{LED}

Figure 14. Input Voltage: 90 V_{AC}, Input Frequency: 64 Hz

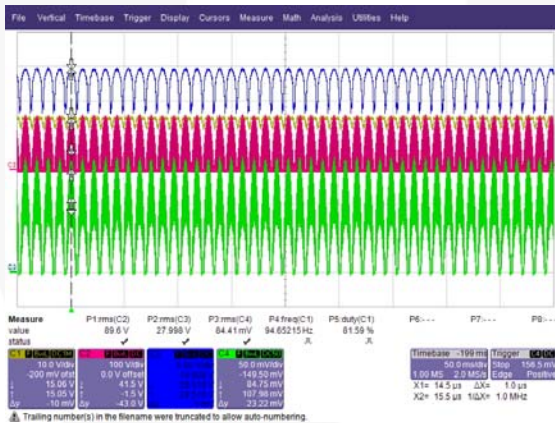

H1: V_{CC}, CH2: V_{DRAIN}, CH3: V_{LED}, CH4: I_{LED}

Figure 15. Input Voltage: 110 V_{AC}, Input Frequency: 47 Hz

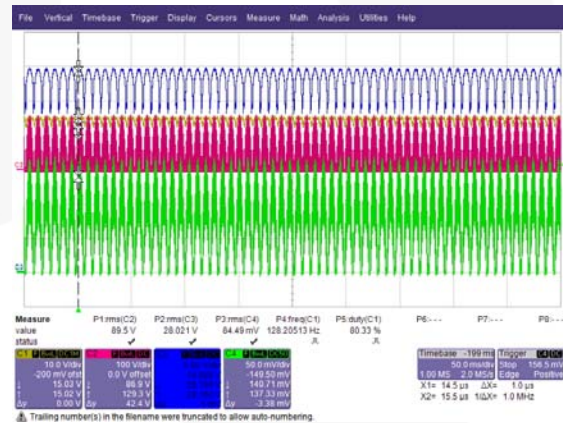

H1: V_{CC}, CH2: V_{DRAIN}, CH3: V_{LED}, CH4: I_{LED}

Figure 16. Input Voltage: 110 V_{AC}, Input Frequency: 64 Hz

Typical Operating Waveforms: Output Characteristics

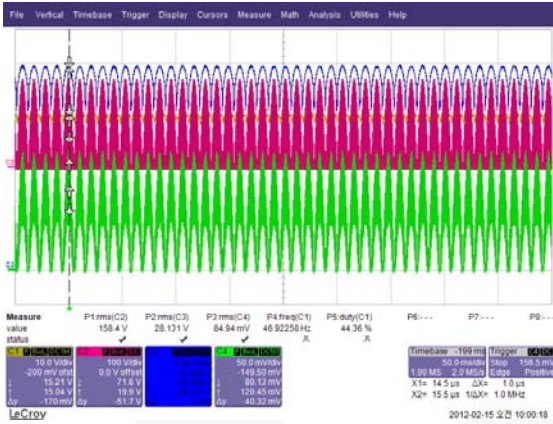

CH1: V_{CC}, CH2: V_{DRAIN}, CH3: V_{LED}, CH4: I_{LED}

Figure 17. Input Voltage: 180 V_{AC}, Input Frequency: 47 Hz

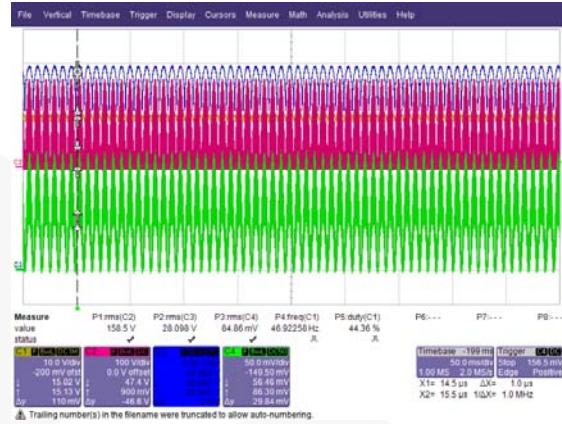

CH1: V_{CC}, CH2: V_{DRAIN}, CH3: V_{LED}, CH4: I_{LED}

Figure 18. Input Voltage: 180 V_{AC}, Input Frequency: 64 Hz

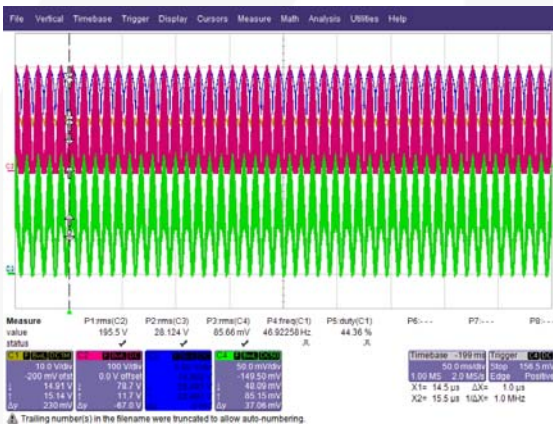

CH1: V_{CC}, CH2: V_{DRAIN}, CH3: V_{LED}, CH4: I_{LED}

Figure 19. Input Voltage: 220 V_{AC}, Input Frequency: 47 Hz

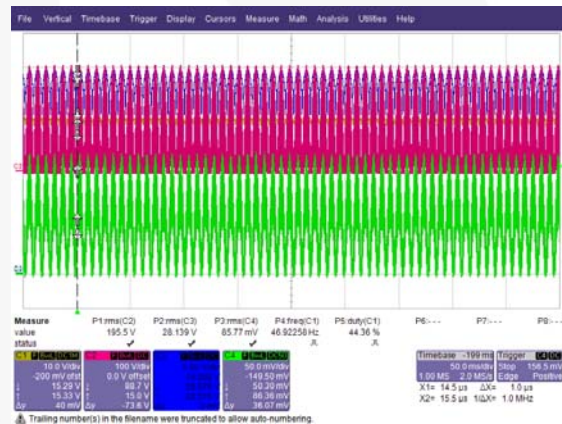

CH1: V_{CC}, CH2: V_{DRAIN}, CH3: V_{LED}, CH4: I_{LED}

Figure 20. Input Voltage: 220 V_{AC}, Input Frequency: 64 Hz

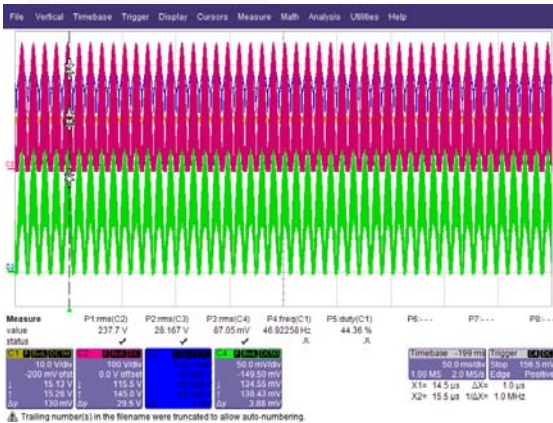

H1: V_{CC}, CH2: V_{DRAIN}, CH3: V_{LED}, CH4: I_{LED}

Figure 21. Input Voltage: 265 V_{AC}, Input Frequency: 47 Hz

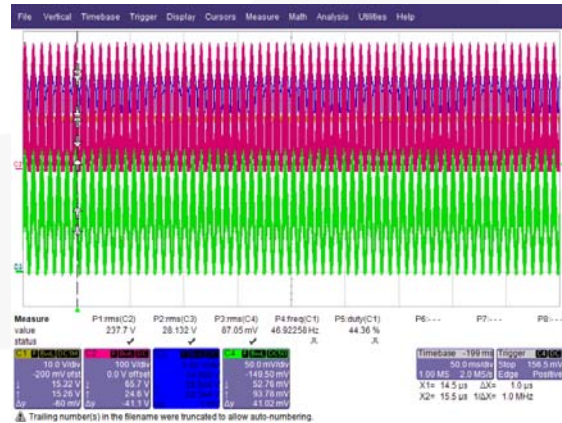

H1: V_{CC}, CH2: V_{DRAIN}, CH3: V_{LED}, CH4: I_{LED}

Figure 22. Input Voltage: 265 V_{AC}, Input Frequency: 64 Hz

Table 3. Output Characteristics by Input Voltage & Frequency

	47 Hz		64 Hz	
	V _{LED(RMS)}	I _{LED(RMS)}	V _{LED(RMS)}	I _{LED(RMS)}
90 V_{AC}	27.91 V	84.45 mA	27.90 V	84.58 mA
110 V_{AC}	27.99 V	84.41 mA	28.02 V	84.49 mA
180 V_{AC}	28.13 V	84.94 mA	28.10 V	84.86 mA
220 V_{AC}	28.12 V	85.66 mA	28.14 V	85.77 mA
265 V_{AC}	28.17 V	87.05 mA	28.13 V	87.05 mA

7.4. Typical Waveforms: Abnormal Mode (LED Open)

Figure 23 and Figure 24 show the open-load condition test method and result. When the LED disconnects from the system, the IC cannot operate because the HV pin is disconnected.

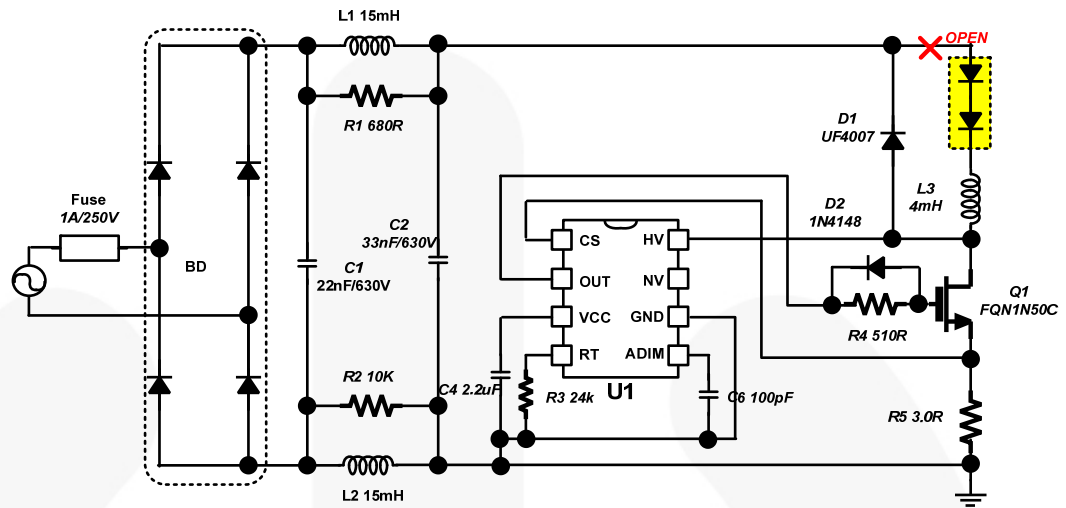
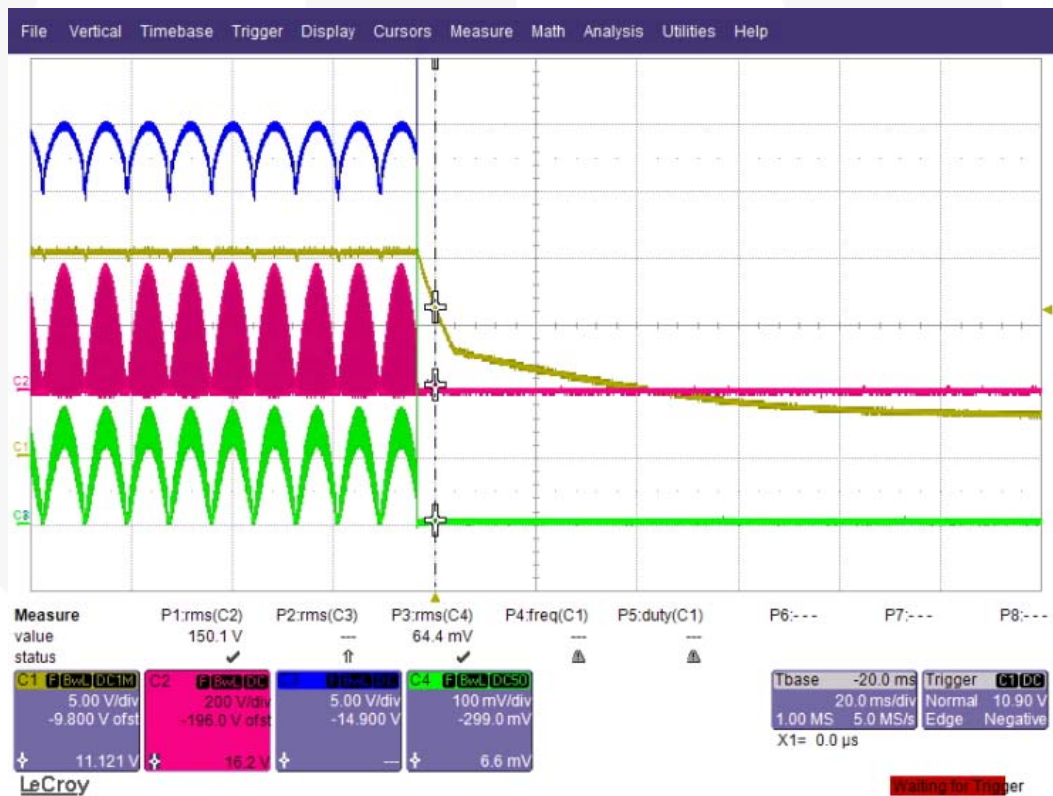

Figure 23. Open-Load Condition Test



CH1: V_{CC}, CH2: V_{DRAIN}, CH3: V_{LED}, CH4: I_{LED}

Figure 24. Test Results of Open-Load Condition

7.5. Typical Waveforms: Abnormal Mode (Inductor Short Condition)

Figure 25 and Figure 26 show the test method and result of an inductor short condition. The FL7701 uses an abnormal over-current protection (AOCP) function, limiting the current on RCS in the event of an inductor short condition.

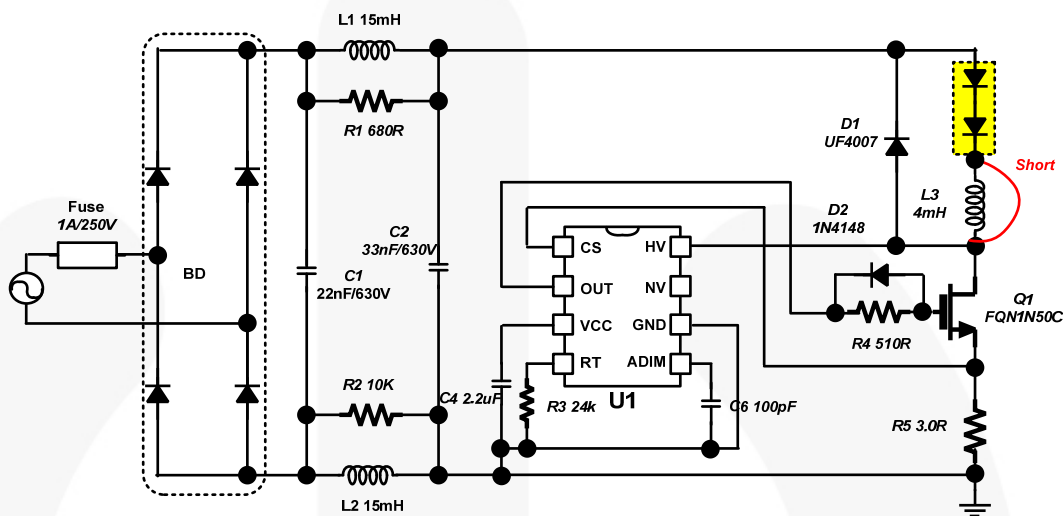
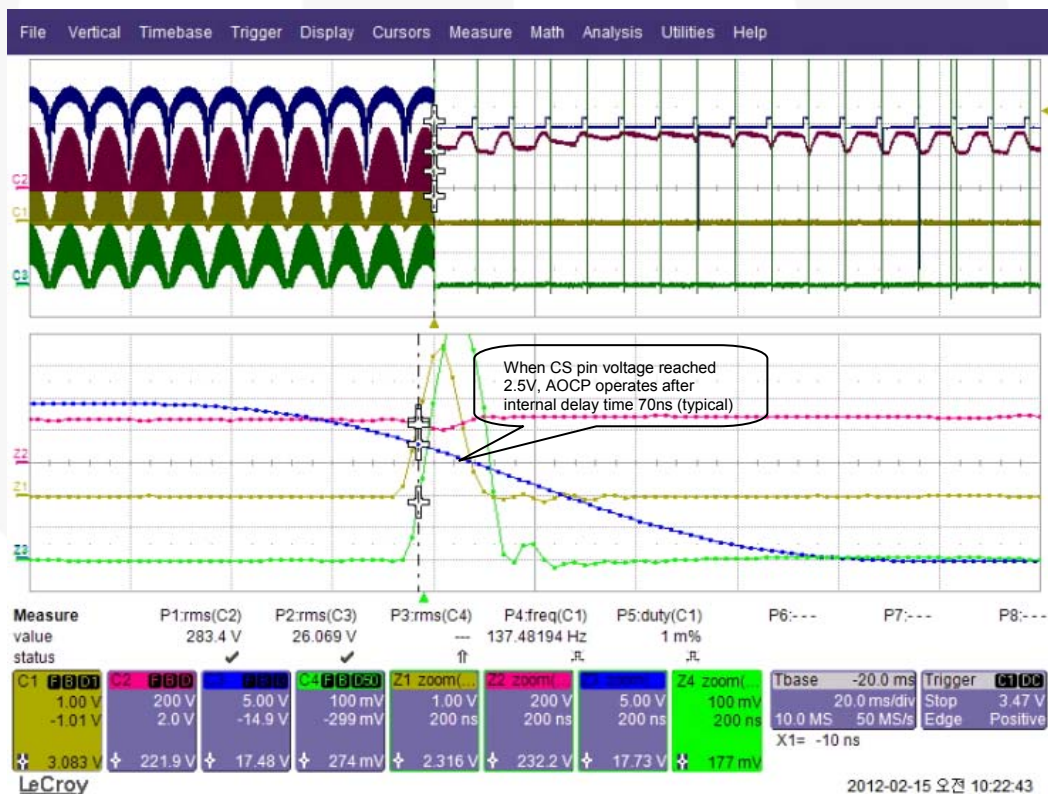

Figure 25. Inductor Short Condition



CH1: V_{CS}, CH2: V_{DRAIN}, CH3: V_{LED}, CH4: I_{LED}
Figure 26. Test Results of Inductor Short Condition

7.6. Power Factor (PF) at Rated Load Condition

Figure 27 shows the system PF performance for the entire input voltage range (90 V to 265 V) at different input frequency conditions (47 Hz, 64 Hz). The PF slightly changes according to the input frequency but can achieve over 86% at 265 V_{AC} condition.

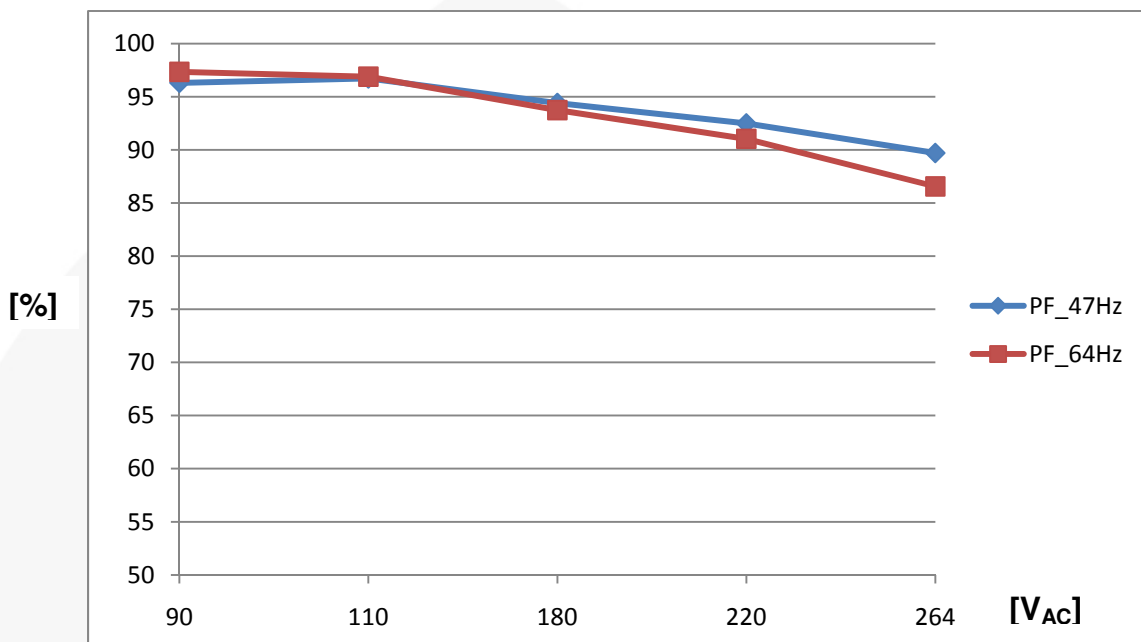

Figure 27. Power Factor

Table 4. Power Factor Test Results

Input Voltage		Power Factor
90 V _{AC}	47 Hz	96.31
	64 Hz	97.34
110 V _{AC}	47 Hz	96.72
	64 Hz	96.89
180 V _{AC}	47 Hz	94.41
	64 Hz	93.74
220 V _{AC}	47 Hz	92.49
	64 Hz	91.09
265 V _{AC}	47 Hz	89.71
	64 Hz	86.56

7.7. Total Harmonic Discharge (THD) Performance

Figure 28 shows the THD performance at different input frequencies. Test results are quite similar, except the 90 V_{AC} condition, but meets international regulations (under 30%).

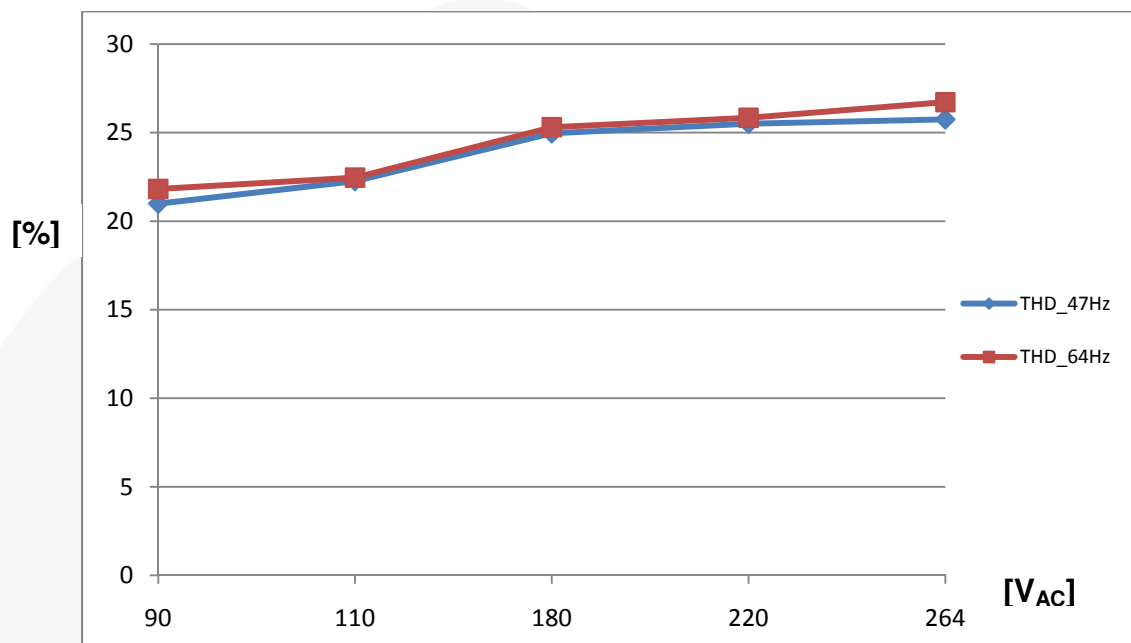

Figure 28. Total Harmonic Distortion Performance

Table 5. Total Harmonic Distortion Test Results

Input Voltage	Frequency	THD (%)
90 V _{AC}	47 Hz	20.99
	64 Hz	21.82
110 V _{AC}	47 Hz	22.26
	64 Hz	22.46
180 V _{AC}	47 Hz	24.96
	64 Hz	25.31
220 V _{AC}	47 Hz	25.50
	64 Hz	25.84
265 V _{AC}	47 Hz	25.75
	64 Hz	26.72

7.8. System Efficiency

Figure 29 shows system efficiency results for different AC input voltage frequency conditions. As shown, the input frequency has negligible effect on system efficiency.

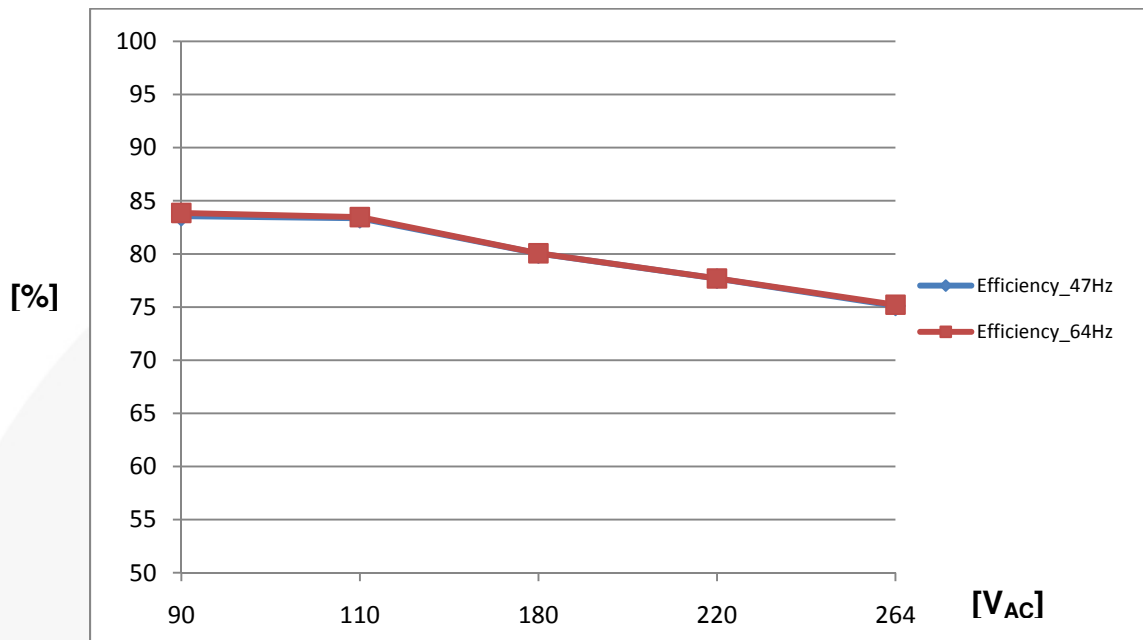

Figure 29. System Efficiency

Table 6. Efficiency Test Results

Input Voltage	Frequency	Efficiency (%)
90 V _{AC}	47 Hz	83.56
	64 Hz	83.83
110 V _{AC}	47 Hz	83.36
	64 Hz	83.46
180 V _{AC}	47 Hz	80.04
	64 Hz	80.06
220 V _{AC}	47 Hz	77.68
	64 Hz	77.69
265 V _{AC}	47 Hz	75.11
	64 Hz	75.22

7.9. Thermal Performance

Figure 30 through Figure 37 show the steady-state thermal results with different input voltage conditions. Inductor L3 has the highest temperature on the top side of the PCB due to copper resistance. The FL7701 has the highest temperature on the bottom side of the PCB due to power loss associated with the high-voltage device. The IC temperature is 66.5°C for the 220 V_{AC} input condition.

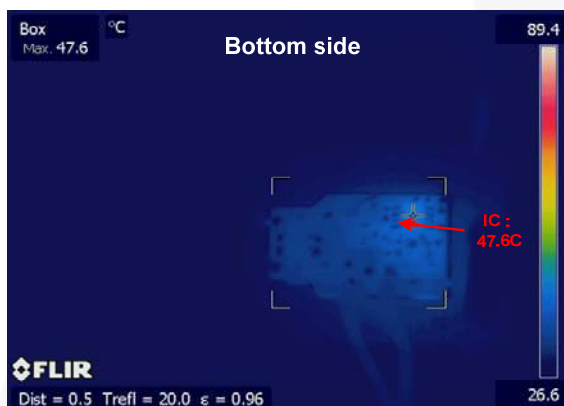

Figure 30. Thermal Test Result, Bottom-Side Temperature at 90 V_{AC} Condition (IC)

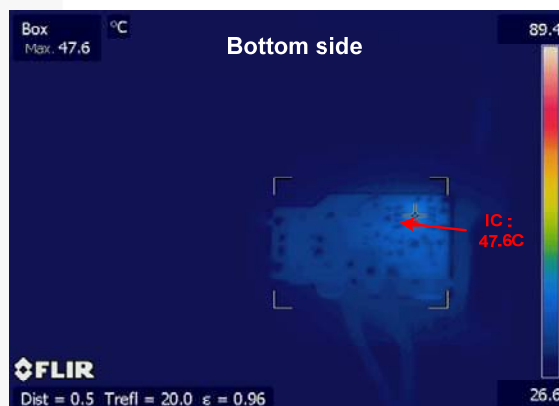

Figure 31. Thermal Test Result, Top-Side Temperature at 90 V_{AC} Condition (Inductor)

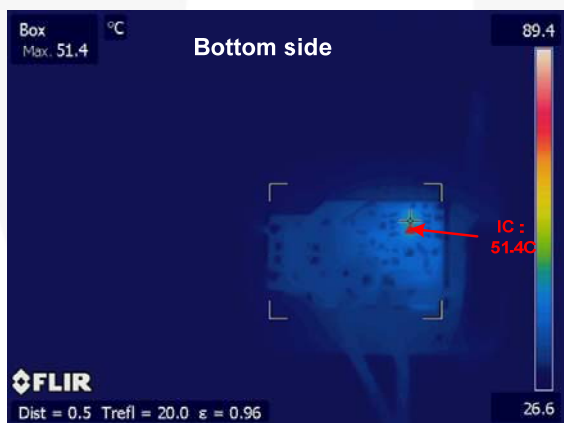

Figure 32. Thermal Test Result, Bottom-Side Temperature at 110 V_{AC} Condition (IC)

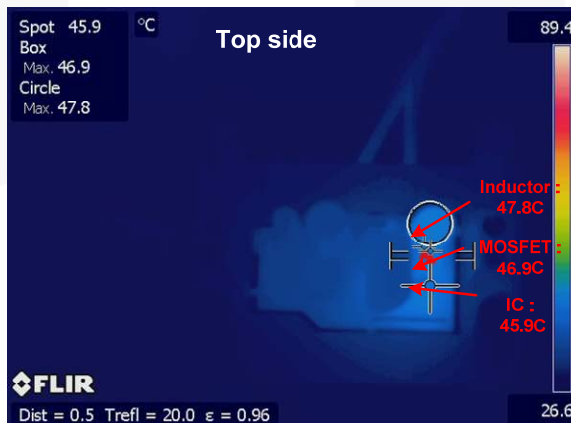

Figure 33. Thermal Test Result, Top-Side Temperature at 110 V_{AC} Condition (Inductor)

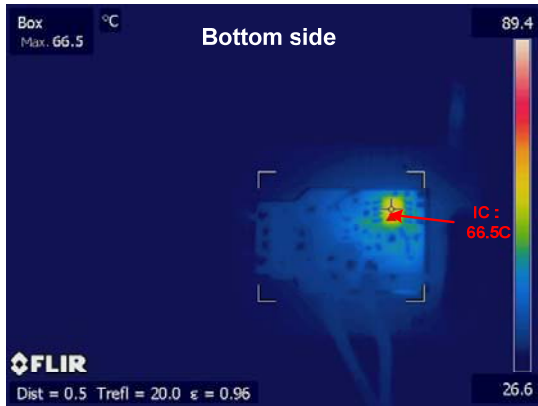

Figure 34. Thermal Test Result, Bottom-Side Temperature at 220 V_{AC} Condition (IC)

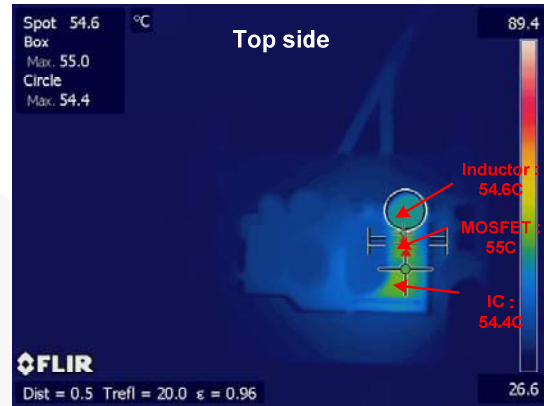

Figure 35. Thermal Test Result, Top-Side Temperature at 220 V_{AC} Condition (Inductor)

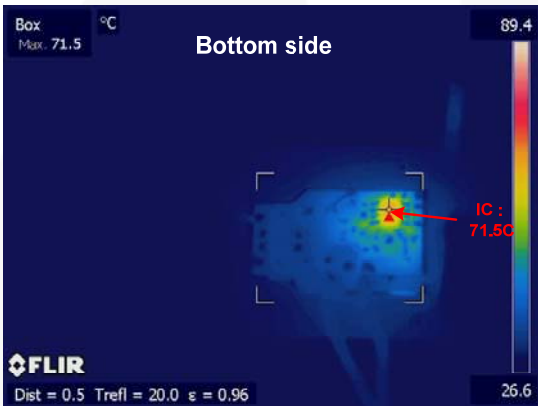

Figure 36. Thermal Test Result, Bottom-Side Temperature at 264 V_{AC} Condition (IC)

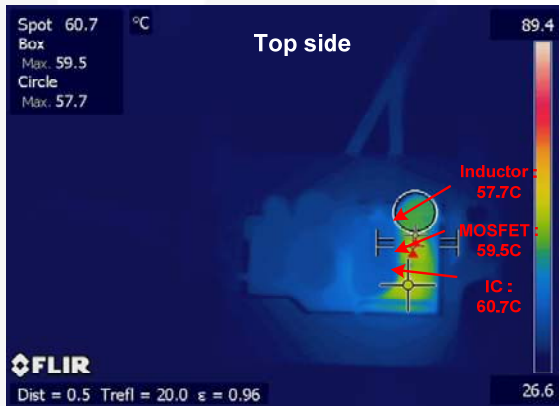

Figure 37. Thermal Test Result, Top-Side Temperature at 264 V_{AC} Condition (Inductor)

Table 7. Temperature Performance by Input Voltage

Input Voltage	T _{IC}	T _{MOSFET}	T _{INDUCTOR}
90 V _{AC}	47.6°C	46.2°C	47.8°C
110 V _{AC}	51.4°C	46.9°C	47.8°C
220 V _{AC}	66.5°C	55.0°C	54.6°C
265 V _{AC}	71.5°C	59.5°C	57.7°C

7.10. Electromagnetic Interference (EMI) Results

EMI test measurements were conducted in observance of CISPR22 criteria, which has tighter stricter limits than CISPR15 for lighting applications.

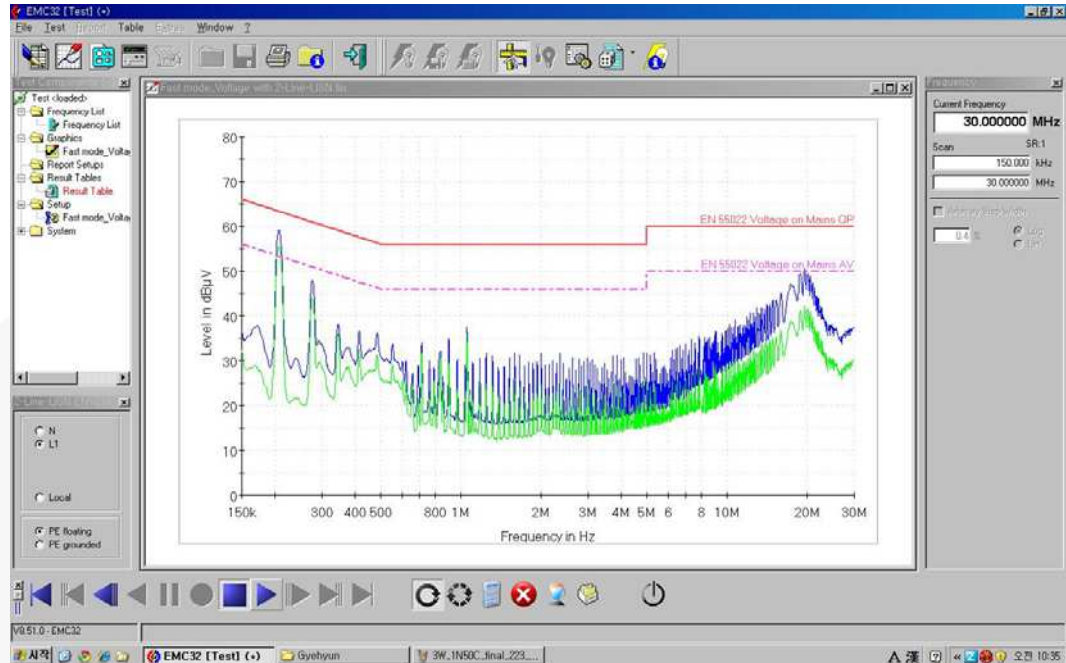

Figure 38. EMI Test Results, Conducted Emission-Line at 11 0V_{AC} Input Condition, Full Load (10-LED Series)

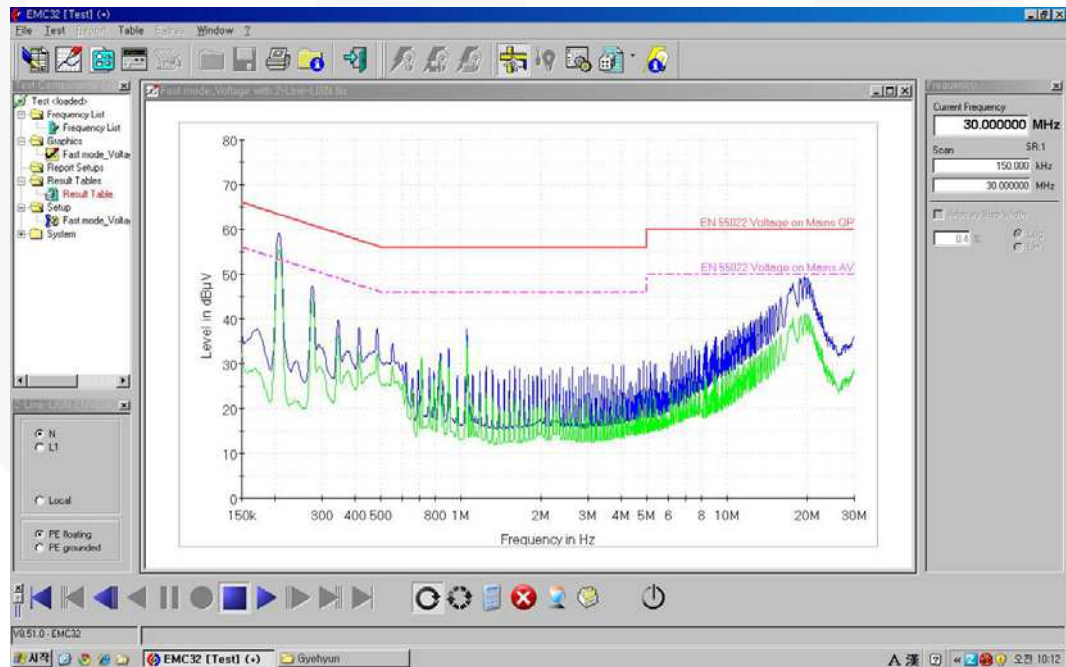

Figure 39. EMI Test Results, Conducted Emission-Neutral at 110 V_{AC} Input Condition, Full Load (10-LED Series)

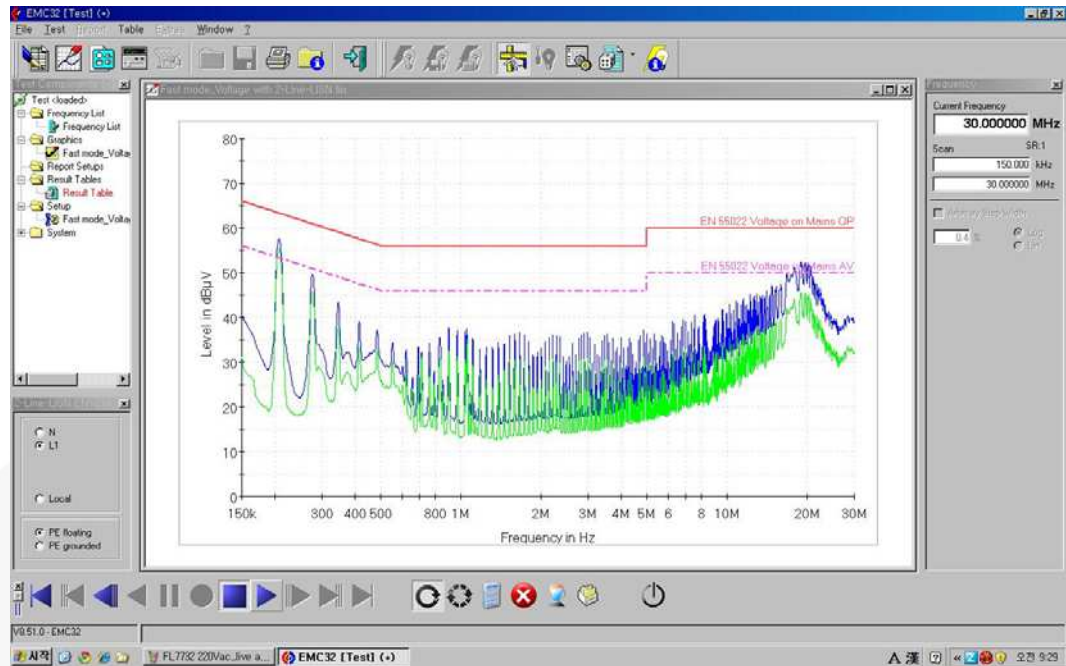

Figure 40. EMI Test Results, Conducted Emission-Neutral at 220 V_{AC} Input Condition, Full Load (10-LED Series)

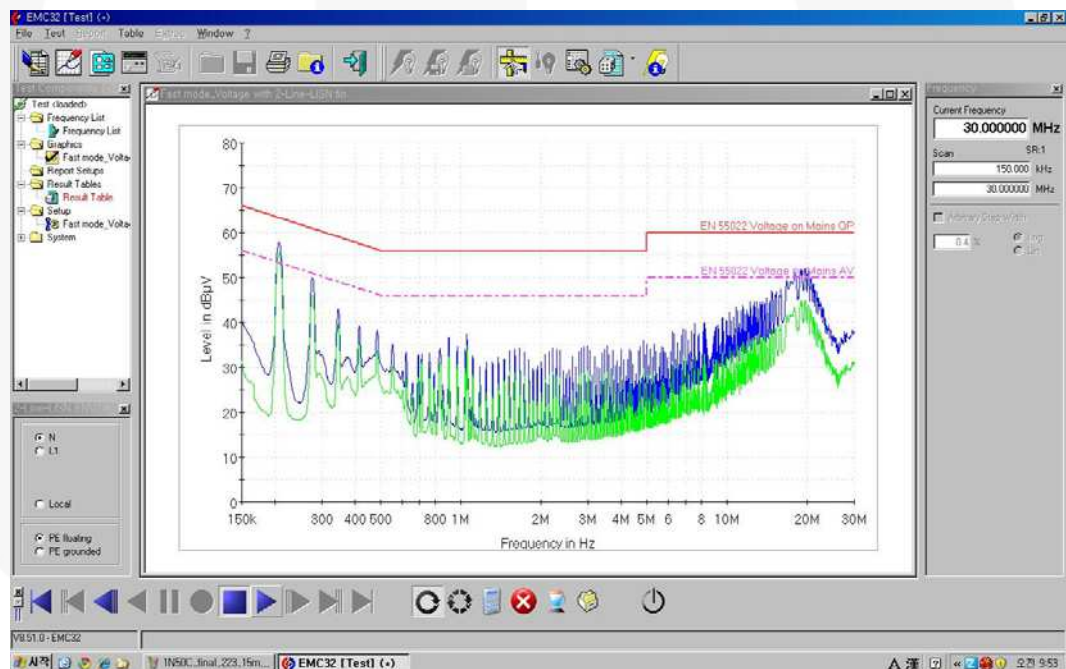

Figure 41. EMI Test Results, Conducted Emission-Neutral at 220 V_{AC} Input Condition, Full Load (10-LED Series)

8. Revision History

Rev.	Date	Description
1.0.0	Nov. 2011.	First issue
1.0.1	Dec. 2011.	Update IC temperature
1.0.2	Feb. 2012.	Modified, edited, formatted document. Changed User Guide number from FEB_L030 to FEBFL7701_L30U003A
1.0.3	Aug. 2012	Formatted document

WARNING AND DISCLAIMER

Replace components on the Evaluation Board only with those parts shown on the parts list (or Bill of Materials) in the Users' Guide. Contact an authorized Fairchild representative with any questions.

This board is intended to be used by certified professionals, in a lab environment, following proper safety procedures. Use at your own risk. The Evaluation board (or kit) is for demonstration purposes only and neither the Board nor this User's Guide constitute a sales contract or create any kind of warranty, whether express or implied, as to the applications or products involved. Fairchild warrants that its products meet Fairchild's published specifications, but does not guarantee that its products work in any specific application. Fairchild reserves the right to make changes without notice to any products described herein to improve reliability, function, or design. Either the applicable sales contract signed by Fairchild and Buyer or, if no contract exists, Fairchild's standard Terms and Conditions on the back of Fairchild invoices, govern the terms of sale of the products described herein.

DISCLAIMER

FAIRCHILD SEMICONDUCTOR RESERVES THE RIGHT TO MAKE CHANGES WITHOUT FURTHER NOTICE TO ANY PRODUCTS HEREIN TO IMPROVE RELIABILITY, FUNCTION, OR DESIGN. FAIRCHILD DOES NOT ASSUME ANY LIABILITY ARISING OUT OF THE APPLICATION OR USE OF ANY PRODUCT OR CIRCUIT DESCRIBED HEREIN; NEITHER DOES IT CONVEY ANY LICENSE UNDER ITS PATENT RIGHTS, NOR THE RIGHTS OF OTHERS.

LIFE SUPPORT POLICY

FAIRCHILD'S PRODUCTS ARE NOT AUTHORIZED FOR USE AS CRITICAL COMPONENTS IN LIFE SUPPORT DEVICES OR SYSTEMS WITHOUT THE EXPRESS WRITTEN APPROVAL OF THE PRESIDENT OF FAIRCHILD SEMICONDUCTOR CORPORATION.

As used herein:

1. Life support devices or systems are devices or systems which, (a) are intended for surgical implant into the body, or (b) support or sustain life, or (c) whose failure to perform when properly used in accordance with instructions for use provided in the labeling, can be reasonably expected to result in significant injury to the user.
2. A critical component is any component of a life support device or system whose failure to perform can be reasonably expected to cause the failure of the life support device or system, or to affect its safety or effectiveness.

ANTI-COUNTERFEITING POLICY

Fairchild Semiconductor Corporation's Anti-Counterfeiting Policy. Fairchild's Anti-Counterfeiting Policy is also stated on our external website, www.fairchildsemi.com, under Sales Support.

Counterfeiting of semiconductor parts is a growing problem in the industry. All manufacturers of semiconductor products are experiencing counterfeiting of their parts. Customers who inadvertently purchase counterfeit parts experience many problems such as loss of brand reputation, substandard performance, failed applications, and increased cost of production and manufacturing delays. Fairchild is taking strong measures to protect ourselves and our customers from the proliferation of counterfeit parts. Fairchild strongly encourages customers to purchase Fairchild parts either directly from Fairchild or from Authorized Fairchild Distributors who are listed by country on our web page cited above. Products customers buy either from Fairchild directly or from Authorized Fairchild Distributors are genuine parts, have full traceability, meet Fairchild's quality standards for handling and storage and provide access to Fairchild's full range of up-to-date technical and product information. Fairchild and our Authorized Distributors will stand behind all warranties and will appropriately address any warranty issues that may arise. Fairchild will not provide any warranty coverage or other assistance for parts bought from Unauthorized Sources. Fairchild is committed to combat this global problem and encourage our customers to do their part in stopping this practice by buying direct or from authorized distributors.

EXPORT COMPLIANCE STATEMENT

These commodities, technology, or software were exported from the United States in accordance with the Export Administration Regulations for the ultimate destination listed on the commercial invoice. Diversion contrary to U.S. law is prohibited.

U.S. origin products and products made with U.S. origin technology are subject to U.S. Re-export laws. In the event of re-export, the user will be responsible to ensure the appropriate U.S. export regulations are followed.