



Chipsmall Limited consists of a professional team with an average of over 10 year of expertise in the distribution of electronic components. Based in Hongkong, we have already established firm and mutual-benefit business relationships with customers from,Europe,America and south Asia,supplying obsolete and hard-to-find components to meet their specific needs.

With the principle of "Quality Parts,Customers Priority,Honest Operation,and Considerate Service",our business mainly focus on the distribution of electronic components. Line cards we deal with include Microchip,ALPS,ROHM,Xilinx,Pulse,ON,Everlight and Freescale. Main products comprise IC,Modules,Potentiometer,IC Socket,Relay,Connector.Our parts cover such applications as commercial,industrial, and automotives areas.

We are looking forward to setting up business relationship with you and hope to provide you with the best service and solution. Let us make a better world for our industry!



Contact us

Tel: +86-755-8981 8866 Fax: +86-755-8427 6832

Email & Skype: info@chipsmall.com Web: www.chipsmall.com

Address: A1208, Overseas Decoration Building, #122 Zhenhua RD., Futian, Shenzhen, China





Is Now Part of



ON Semiconductor®

To learn more about ON Semiconductor, please visit our website at
www.onsemi.com

ON Semiconductor and the ON Semiconductor logo are trademarks of Semiconductor Components Industries, LLC dba ON Semiconductor or its subsidiaries in the United States and/or other countries. ON Semiconductor owns the rights to a number of patents, trademarks, copyrights, trade secrets, and other intellectual property. A listing of ON Semiconductor's product/patent coverage may be accessed at www.onsemi.com/site/pdf/Patent-Marking.pdf. ON Semiconductor reserves the right to make changes without further notice to any products herein. ON Semiconductor makes no warranty, representation or guarantee regarding the suitability of its products for any particular purpose, nor does ON Semiconductor assume any liability arising out of the application or use of any product or circuit, and specifically disclaims any and all liability, including without limitation special, consequential or incidental damages. Buyer is responsible for its products and applications using ON Semiconductor products, including compliance with all laws, regulations and safety requirements or standards, regardless of any support or applications information provided by ON Semiconductor. "Typical" parameters which may be provided in ON Semiconductor data sheets and/or specifications can and do vary in different applications and actual performance may vary over time. All operating parameters, including "Typicals" must be validated for each customer application by customer's technical experts. ON Semiconductor does not convey any license under its patent rights nor the rights of others. ON Semiconductor products are not designed, intended, or authorized for use as a critical component in life support systems or any FDA Class 3 medical devices or medical devices with a same or similar classification in a foreign jurisdiction or any devices intended for implantation in the human body. Should Buyer purchase or use ON Semiconductor products for any such unintended or unauthorized application, Buyer shall indemnify and hold ON Semiconductor and its officers, employees, subsidiaries, affiliates, and distributors harmless against all claims, costs, damages, and expenses, and reasonable attorney fees arising out of, directly or indirectly, any claim of personal injury or death associated with such unintended or unauthorized use, even if such claim alleges that ON Semiconductor was negligent regarding the design or manufacture of the part. ON Semiconductor is an Equal Opportunity/Affirmative Action Employer. This literature is subject to all applicable copyright laws and is not for resale in any manner.



FL7734 Single-Stage Primary-Side-Regulation PWM Controller for PFC and Phase Cut Dimmable LED Driving

Features

- Excellent Dimmer Compatibility by Active Dimming Control
- Programmable Dimming Curve and Input Current Management
- Constant LED Current Regulation in Large Phase Angle Range
- Cost-Effective Solution without Input Bulk Capacitor and Feedback Circuitry
- Accurate Constant-Current (CC) Control, Independent on Line Voltage, Output Voltage, Magnetizing Inductance Variation
- Power Factor Correction (PFC)
- Fast Startup utilizing Bleeding Circuit
- Open-LED Protection
- Short-LED Protection
- Sensing Resistor Short Protection
- Cycle-by-Cycle Current Limiting
- Over-Temperature Protection with Auto Restart

Applications

- LED Lighting System

Description

The FL7734 is a highly integrated PWM controller with advanced Primary-Side-Regulation (PSR) technique to minimize components for low power LED lighting solutions. Using the innovative TRUECURRENT® technology for tight constant-current control, it enables designs with constant-current (CC) tolerance of less than ±1% in the wide line voltage range to meet stringent LED brightness requirements.

FL7734 can operate with all types of phase cut dimmers. Phase cut dimming is managed smoothly by Fairchild’s proprietary constant input current control and bleeding current control to achieve excellent dimmer compatibility without visible flicker.

The controller can automatically detect whether there is a dimmer connection. In non dimming mode, the operating mode is set to optimize power factor and THD by enabling linear frequency control and voltage mode based on DCM.

An external high-voltage bleeding circuit is utilized to implement fast startup and high system efficiency. The FL7734 also provides powerful protections, such as LED open / short, sensing resistor shorted, and over-temperature for high system reliability. The FL7734 is available in 16-pin Small-Outline Package (SOP).

Related Resources

[FL7734 Product Folder](#)

Ordering Information

Part Number	Operating Temperature Range	Package	Packing Method
FL7734MX	-40°C to +125°C	16-Lead, Small Outline Package (SOP-16)	Tape & Reel

Application Diagram

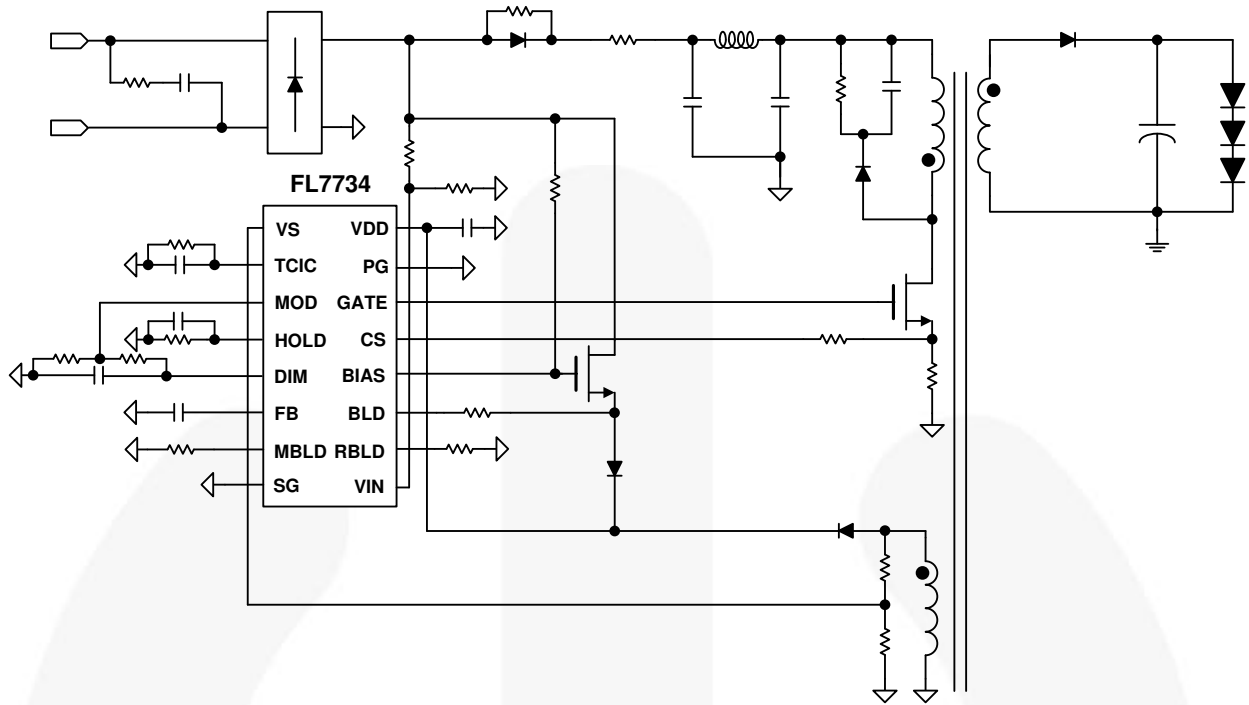

Figure 1. Typical Application

Internal Block Diagram

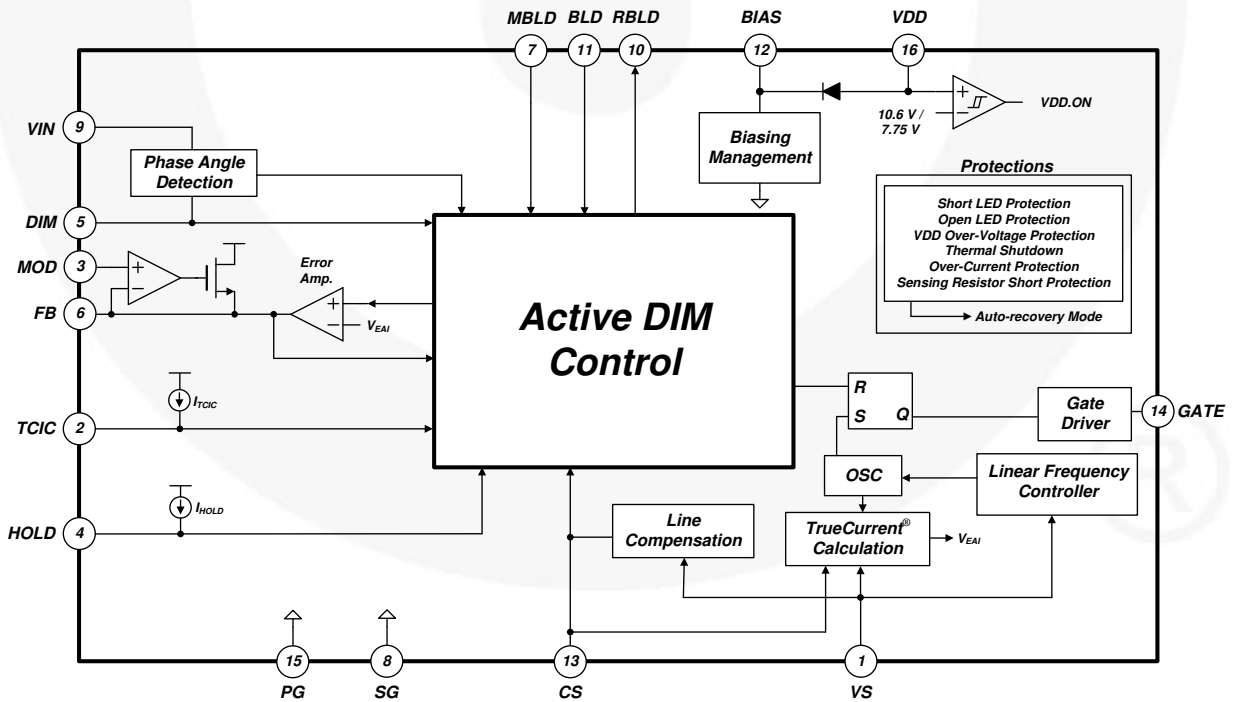
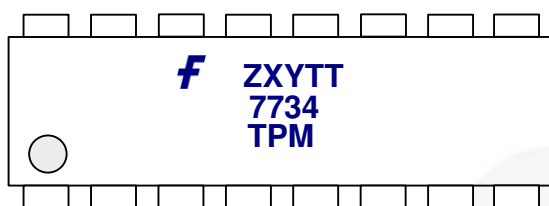

Figure 2. Functional Block Diagram

Marking Information



F: Fairchild Logo
 Z: Plant Code
 X: 1-Digit Year Code
 Y: 1-Digit Week Code
 TT: 2-Digit Die Run Code
 T: Package Type (M=SOP)
 P: Z: Pb free, Y: Green package
 M: Manufacture Flow Code

Figure 3. Top Mark

Pin Configuration

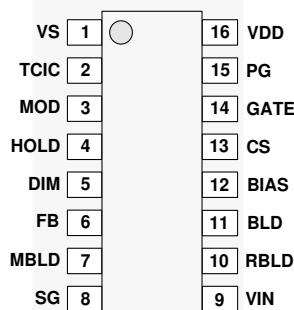

Figure 4. Pin Configuration

Pin Definitions

Pin #	Name	Description
1	VS	Voltage Sense. VS pin detects the output voltage for linear frequency control and discharge time for output current regulation. VS voltage detection protects LED open and short conditions.
2	TCIC	Constant Input Current. TCIC manages switching mode control.
3	MOD	Modulation. Min. FB is clamped by MOD voltage.
4	HOLD	Holding Current. External HOLD resistor sets the level of constant input current.
5	DIM	Phase Angle Sense. DIM voltage indicates the amount of phase angle. It is the reference voltage of the error amplifier in the feedback loop.
6	FB	Feedback. FB is the output of the error amplifier.
7	MBLD	Maximum Bleeding. Resistor connected to MBLD determines maximum bleeding current.
8	SG	Signal Ground.
9	VIN	Input Voltage Sense. VIN pin detects input voltage for phase angle detection.
10	RBLD	Bleeding Control Resistor. RBLD current set by external resistor decides the amount of bleeding current.
11	BLD	Bleeding Control. BLD flows current into RBLD.
12	BIAS	Bleeding Circuit BIAS. External bleeding switch is biased by an internal clamping circuit via BIAS pin.
13	CS	Current Sense. CS pin connects a current-sense resistor to detect the MOSFET current for the output current regulation. Over-current protection and sensing resistor short protection are triggered by this pin.
14	GATE	PWM Signal Output. Gate driver in this pin switches power MOSFET.
15	PG	Power Ground.
16	VDD	Power Supply. Connects to a decoupling capacitor. IC operating current and MOSFET driving current are supplied from this pin.

Absolute Maximum Ratings

Stresses exceeding the absolute maximum ratings may damage the device. The device may not function or be operable above the recommended operating conditions and stressing the parts to these levels is not recommended. In addition, extended exposure to stresses above the recommended operating conditions may affect device reliability. The absolute maximum ratings are stress ratings only.

Symbol	Parameter		Min.	Max.	Unit
V _{VDD}	DC Supply Voltage ^(1,2)		-0.3	30	V
V _{DIM}	DIM Pin Input Voltage		-0.3	6.0	V
V _{MOD}	MOD Pin Input Voltage		-0.3	6.0	V
V _{HOLD}	HOLD Pin Input Voltage		-0.3	6.0	V
V _{TCIC}	TCIC Pin Input Voltage		-0.3	6.0	V
V _{FB}	FB Pin Input Voltage		-0.3	6.0	V
V _{RBLD}	RBLD Pin Input Voltage		-0.3	6.0	V
V _{BIAS}	BIAS Pin Input Voltage		-0.3	30.0	V
V _{BLD}	BLD Pin Input Voltage		-0.3	30.0	V
V _{MBLD}	MBLD Pin Input Voltage		-0.3	6.0	V
V _{VS}	VS Pin Input Voltage		-0.3	6.0	V
V _{CS}	CS Pin Input Voltage		-0.3	6.0	V
V _{GATE}	GATE Pin Input Voltage		-0.3	30.0	V
V _{VIN}	VIN Pin Input Voltage		-0.3	30.0	V
P _D	Power Dissipation (T _A < 50°C)			909	mW
θ _{JA}	Thermal Resistance (Junction to Air)			110	°C /W
T _J	Maximum Junction Temperature			150	°C
T _{STG}	Storage Temperature Range		-55	150	°C
T _L	Lead Temperature (Soldering, 10 Seconds)			260	°C
ESD	Electrostatic Discharge Capability	Human Body Model, ANSI/ESDA/JEDEC JS-001-2012		5	kV
		Charged Device Model, JESD22-C101		2	

Notes:

1. Stresses beyond those listed under Absolute Maximum Ratings may cause permanent damage to the device.
2. All voltage values, except differential voltages, are given with respect to the GND pin.

Recommended Operating Conditions

The Recommended Operating Conditions table defines the conditions for actual device operation. Recommended operating conditions are specified to ensure optimal performance to the datasheet specifications. Fairchild does not recommend exceeding them or designing to Absolute Maximum Ratings.

Symbol	Parameter	Min.	Max.	Unit
T _A	Operating Ambient Temperature	-40	125	°C

Electrical Characteristics

$V_{DD}=20\text{ V}$ and $T_J=-40 \sim 125^\circ\text{C}$ unless otherwise specified.

Symbol	Parameter	Condition	Min.	Typ.	Max.	Unit
VDD Section						
V_{DD-ON}	Turn-On Threshold Voltage		9.1	10.6	12.1	V
V_{DD-OFF}	Turn-Off Threshold Voltage		6.75	7.75	8.75	V
I_{DD-OP}	Operating Current	$C_{LOAD}=1\text{ nF}$	4	5	6	mA
I_{DD-ST}	Startup Current	$V_{DD}=6\text{ V}$	-	2	10	μA
V_{DD-OVP}	V_{DD} Over-Voltage-Protection		25	27	29	V
$V_{BIAS-VDD-OFF}$	BIAS Clamp Voltage at VDD-OFF	$V_{IN}^{(3)}=30\text{ V}$, $R_{BIAS}=20\text{ k}\Omega$	21.3	24.4	27.5	V
$V_{BIAS-VDD-ON}$	BIAS Clamp Voltage at VDD-ON	$V_{IN}^{(3)}=30\text{ V}$, $R_{BIAS}=20\text{ k}\Omega$	17.6	19.5	21.4	V
Gate Section						
V_{OL}	Output Voltage Low	$I_{GATE}=-1\text{ mA}$			1.5	V
V_{OH}	Output Voltage High	$I_{GATE}=+1\text{ mA}$, $V_{DD}=10\text{ V}$	5			V
I_{source}	Peak Sourcing Current ⁽⁴⁾			60		mA
I_{sink}	Peak Sinking Current ⁽⁴⁾			180		mA
t_r	Rising Time	$C_{LOAD}=1\text{ nF}$	100	150	200	ns
t_f	Falling Time	$C_{LOAD}=1\text{ nF}$	20	60	100	ns
$V_{GATE-CLAMP}$	GATE Clamp Voltage	$V_{DD}=20\text{ V}$	12	15	18	V
Oscillator Section						
f_D	Operating Frequency at D.Mode	$T_J=25^\circ\text{C}$	65	70	75	kHz
f_{ND-MAX}	Max. Frequency at ND.Mode	$T_J=25^\circ\text{C}$	65	70	75	kHz
f_{ND-MIN}	Min. Frequency at ND.Mode	$T_J=25^\circ\text{C}$	26	29.5	33	kHz
t_{ON-MAX}	Maximum Turn-On Time	$T_J=25^\circ\text{C}$	10.4	12.4	14.4	μs
t_{ON-MIN}	Minimum Turn-On Time ⁽⁴⁾	$V_{FB}=0\text{ V}$		600		ns
Current Sense Section						
t_{LEB}	Leading-Edge Blanking Time ⁽⁴⁾			300		ns
t_{PD}	Propagation Delay to GATE		50	100	150	ns
V_{CS}/I_{VS}	Line Compensation Ratio ⁽⁴⁾			21.5		V/A
Voltage Sense Section						
$t_{DIS-BNK}$	t_{DIS} Blanking Time at VS Sampling ⁽⁴⁾			1.5		μs
I_{VS-BNK}	VS Current for VS Blanking		67	80	93	μA
$V_{VS-CLAMP}$	VS Clamping Voltage	$I_{VS}=1\text{ mA}$	-0.1			V
		$I_{VS}=10\text{ }\mu\text{A}$			0.35	V

Notes:

- V_{IN} is external voltage source and R_{BIAS} is connected between V_{IN} and BIAS pin.
- This parameter, although design-guaranteed, is not tested in production.

Electrical Characteristics

$V_{DD}=20\text{ V}$ and $T_J=-40 \sim 125^\circ\text{C}$ unless otherwise specified.

Symbol	Parameter	Condition	Min.	Typ.	Max.	Unit
Feedback Section						
g_M	Transconductance		14	18	22	μmho
$I_{FB-SINK}$	FB Sink Current	$T_J=25^\circ\text{C}$, $V_{EAI}=2\text{ V}$, $V_{FB}=2.5\text{ V}$	14	18	22	μA
$I_{FB-SOURCE}$	FB Source Current	$V_{EAI}=0\text{ V}$, $V_{FB}=2.5\text{ V}$	14	18	22	μA
V_{FB-HGH}	FB High Voltage ⁽⁴⁾		4.7			V
V_{FB-LOW}	FB Low Voltage ⁽⁴⁾				0.1	V
Start Sequence Section						
$t_{SS1-MIN}$	Minimum Start Sequence Time 1		10.8	12.0	13.2	ms
$t_{SS3-MIN}$	Minimum Start Sequence Time 3		13.5	15.0	16.5	ms
$V_{FB-ADJ-NDM}$	FB Adjustment Voltage in ND.MODE		1.26	1.40	1.54	V
Protection Section						
$V_{CS-HIGH-CL}$	High Current Limit Threshold		1.08	1.20	1.32	V
$V_{CS-LOW-CL}$	Low Current Limit Threshold		0.15	0.20	0.25	V
V_{CS-OCP}	Over Current Protection Voltage			1.8		V
$V_{VS-LOW-CL-H}$	Low Current Limit Hys. Voltage 'H' ⁽⁴⁾		0.45	0.50	0.55	V
$V_{VS-LOW-CL-L}$	Low Current Limit Hys. Voltage 'L' ⁽⁴⁾		0.35	0.40	0.45	V
$V_{VS-SLP-TH}$	VS Threshold Voltage for SLP		0.35	0.40	0.45	V
V_{VS-OVP}	VS Threshold Voltage for OVP		2.9	3.0	3.1	V
$t_{AR-DELAY}$	Auto Restart Delay Time ⁽⁴⁾			4.0		s
$V_{CS-SRSP}$	CS Threshold Voltage for SRSP		0.05	0.10	0.15	V
T_{OTP}	Threshold Temperature for OTP ⁽⁴⁾⁽⁵⁾			150		$^\circ\text{C}$
$T_{OTP-HYS}$	Junction Temperature Hysteresis ⁽⁴⁾			10		$^\circ\text{C}$
Dimming Control Section						
I_{DIM}	DIM Sourcing Current	$V_{DIM}=3\text{ V}$	36	40	44	μA
$V_{VIN-DIM}$	DIM Current On/Off Voltage ⁽⁴⁾			3.00		V
$V_{DIM-CLAMP}$	DIM Clamping Voltage			3.25		V
K_{HOLD}	HOLD Conversion Coefficient	$T_J=25^\circ\text{C}$, $V_{CS}=0.5\text{ V}$, $R_{HOLD}=31.5\text{ k}\Omega$		510		/mA
I_{HOLD}	HOLD Sourcing Current	$V_{HOLD}=3.5\text{ V}$	36	40	44	μA
I_{TCIC}	TCIC Sourcing Current		13.5	15.0	16.5	μA
$V_{TCIC-MIN-DIS}$	Minimum TCIC Discharging Voltage		0.9	1.0	1.1	V
$V_{RBLD-CLAMP}$	Clamped RBLD Voltage	$V_{VIN}=5\text{ V}$, $R_{RBLD}=40\ \Omega$	0.45	0.50	0.55	V
I_{MBLD}	MBLD Current	$V_{MBLD}=3.5\text{ V}$	36	40	44	μA

Note:

- If over-temperature protection is activated, the power system enters Auto Recovery Mode and output is disabled. Device operation above the maximum junction temperature is NOT guaranteed.

Typical Performance Characteristics

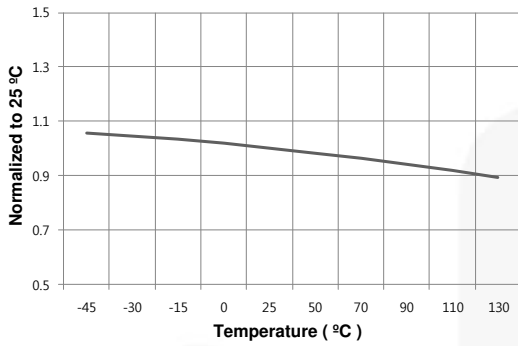

Figure 5. V_{DD-ON} vs. Temperature

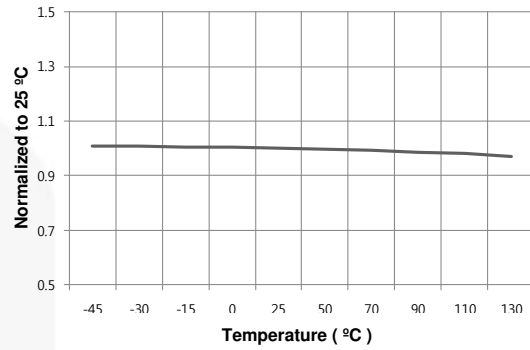

Figure 6. V_{DD-OFF} vs. Temperature

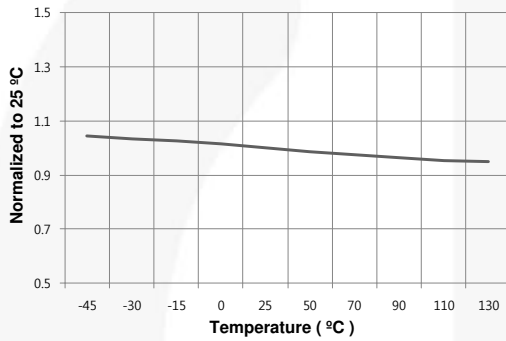

Figure 7. I_{D-OP} vs. Temperature

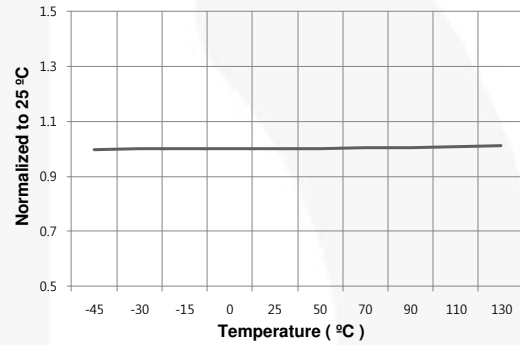

Figure 8. V_{DD-OVP} vs. Temperature

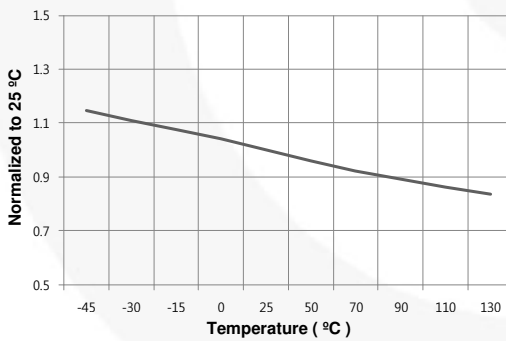

Figure 9. f_{ND-MAX} vs. Temperature

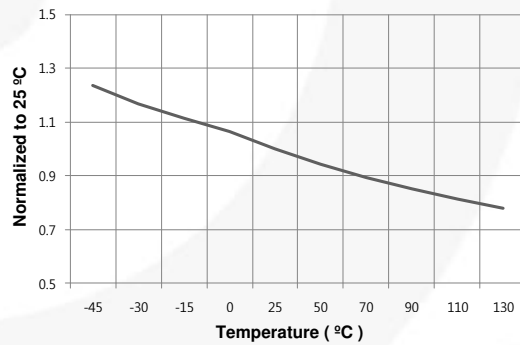

Figure 10. f_{ND-MIN} vs. Temperature

Typical Performance Characteristics

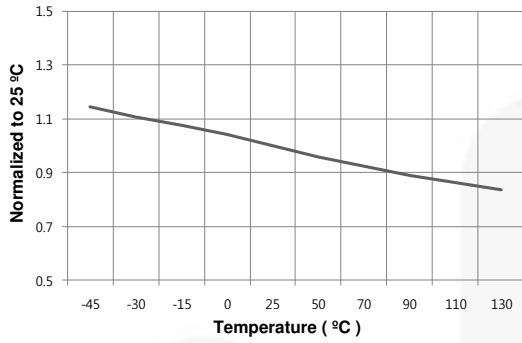

Figure 11. f_D vs. Temperature

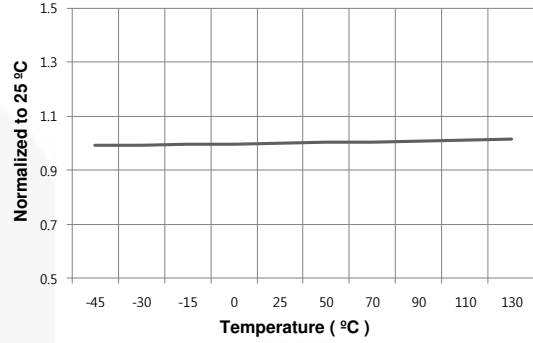

Figure 12. $V_{CS-HIGH-CL}$ vs. Temperature

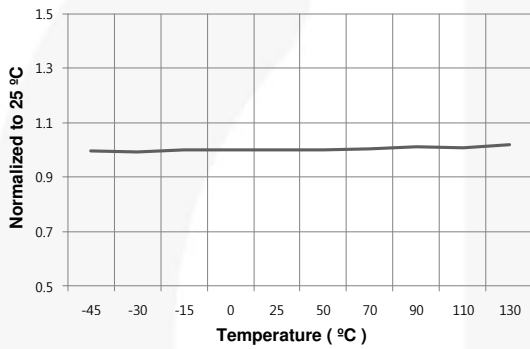

Figure 13. $V_{VS-SLP-TH}$ vs. Temperature

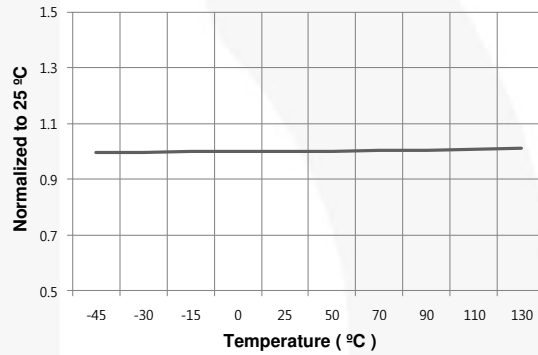

Figure 14. V_{VS-OVP} vs. Temperature

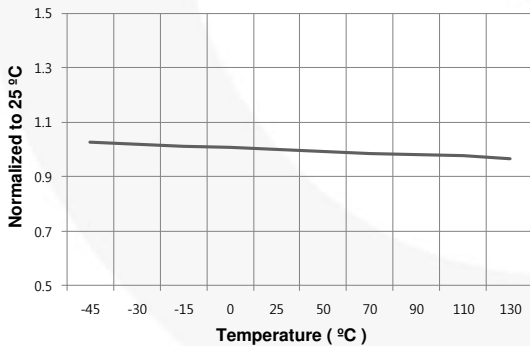

Figure 15. K_{HOLD} vs. Temperature

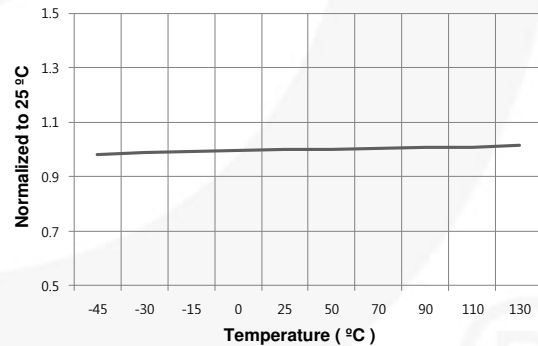

Figure 16. I_{HOLD} vs. Temperature

Functional Description

FL7734 is a phase-cut dimmable PWM controller for LED lighting applications. Accurate LED current regulation independent of input voltage, output voltage and magnetizing inductance variations is implemented by TRUECURRENT[®] technique. The controller features programmable dimming curve which ensures that the constant maximum LED current can be met at the various maximum phase angle conditions of each dimmer and low LED current can be set at the minimum phase angle condition with wide dimming range. Fairchild's proprietary constant input current control provides excellent dimmer compatibility by maintaining input current higher than TRIAC holding current. The linear frequency control and DCM operation with minimized turn-on time ripple implements best power factor and THD in a single-stage topology. A variety of protections; such as short-LED protection, open-LED protection, sensing resistor open/short protection, over-temperature protection, and cycle-by-cycle current limitation stabilize system operation and protect external components.

Startup

An external bleeding MOSFET is utilized for fast startup. Once power is on, BIAS voltage is quickly lifted to $V_{BIAS-VDD-OFF}$ (24.4 V) so the bleeding MOSFET can charge the VDD capacitor higher than V_{DD-ON} voltage (10.6 V). Once V_{DD} is higher than V_{DD-ON} , Startup Sequence (SS1) begins with maximum bleeding current to stabilize dimmer operation. SS1 ends when V_{IN} reaches the line voltage zero crossing after $t_{SS1-MIN}$ (12 ms).

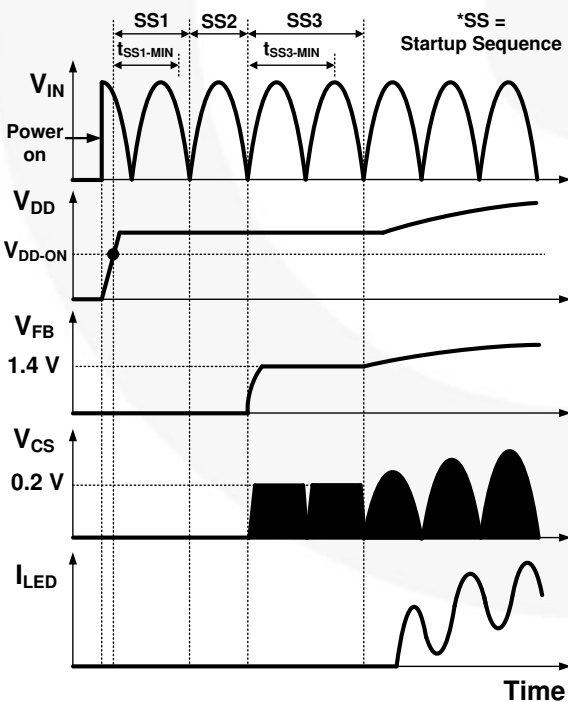

Figure 17. Startup Sequence

During SS2 which is defined as a half line period, FL7734 determines whether phase-cut dimmer is connected in the line. From SS3, internal operation is

set as either dimming mode or non-dimming mode. SS3 time is set longer than $t_{SS3-MIN}$ which is counted except for phase-cut time and finishes synchronized with V_{IN} zero crossing. 0.2 V current-mode is activated during SS3 so that output voltage reaches a level higher than threshold for short-LED protection, which is enabled after SS3. In the mean time, FB voltage is clamped to 1.4 V at non-dimming mode or a certain level proportional to phase angle at dimming mode to set the voltage closer to steady-state level. The maximum bleeding current is disabled after SS3 and voltage mode control is enabled at non-dimming mode and constant input current control is enabled at dimming mode.

Constant-Current Regulation

The output current is estimated using the peak drain current and inductor current discharge time because output current is same as the average of the diode current in steady-state. The peak value of the drain current is determined by the CS pin. The inductor discharge time (t_{dis}) is sensed by a t_{dis} detector. Using three sources of information; peak drain current, inductor discharging time, and operating switching period, the TRUECURRENT[®] block calculates the estimated output current. The output of the calculation is compared with an internal precise reference to generate an error voltage (V_{FB}). With Fairchild's innovative TRUECURRENT[®] technique, constant LED current can be precisely controlled.

Constant Input Current Control

Fairchild's proprietary Constant Input Current (CIC) control generates switching duty to form input current proportional to the external resistor value at HOLD pin. Filtered switch current is the system input current and the system input current is adjusted by the calculation of CS average voltage. Input current is determined by equation (1) where K_{HOLD} is coefficient of internal calculation.

$$I_{IN} = \frac{R_{HOLD}}{R_{CS} \cdot K_{HOLD}} \quad (1)$$

Fairchild's CIC control offers superior accurate and stable current management than other input current control technologies.

Dimming Control

Phase angle is detected by comparing V_{IN} voltage and 3 V threshold voltage ($V_{VIN-DIM}$). When V_{IN} voltage is higher than 3 V, DIM sourcing current (I_{DIM}) is connected to the DIM pin and the current flows into external resistors (R_{DIM1} and R_{DIM2}) and capacitor (C_{DIM}). Therefore, the DIM voltage filtered by C_{DIM} indicates the amount of phase angle controlled by phase-cut dimmer.

$$V_{DIM} = I_{DIM} \cdot (R_{DIM1} + R_{DIM2}) \cdot \frac{PA}{180^\circ} \quad (2)$$

As a function of dimming reference modulation shown in Figure 18, output current is constantly regulated with constant V_{REF} when V_{DIM} is higher than 3 V and V_{REF} is set lower than V_{EAI} (TRUECURRENT® calculation result) when V_{DIM} is lower than 2.25 V. Once V_{DIM} is less than 2.25 V, the error amplifier always pulls down current in the output and FB voltage is clamped by MOD voltage so that open loop control starts for stable LED current control at low phase angle range.

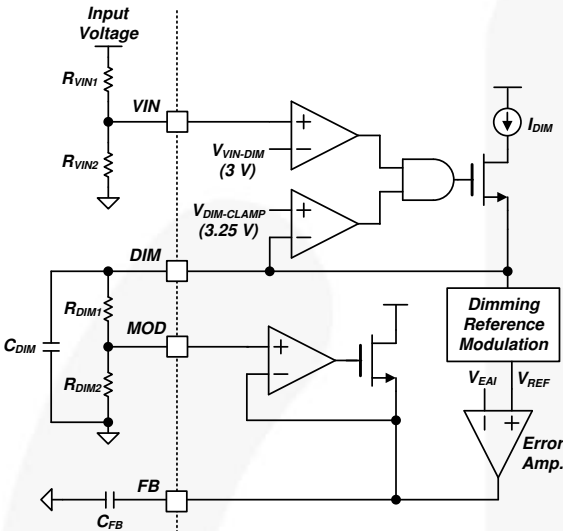

Figure 18. Dimming Control

High dimmer compatibility is implemented by bleeding current generated through BLD to RBLD and having the switching mode management by TCIC.

PFC and THD

In a conventional boost converter, Boundary Conduction Mode (BCM) is generally used to keep input current in phase with input voltage for Power Factor (PF) and Total Harmonic Distortion (THD). However, BCM switching distorts input current in the single stage flyback / buck boost converter because power inductor current is not the same as input current. Moreover, it becomes more difficult to meet PF and THD once passive bleeder (resistor and capacitor in the driver input) is added for successful firing in the single stage TRIAC dimming system.

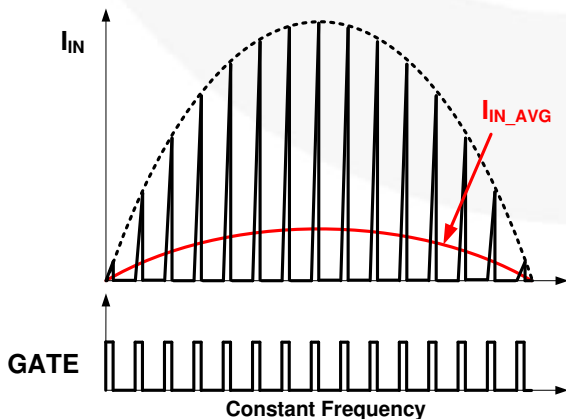

Figure 19. PFC Control in DCM

In order to optimize PF and THD in the single stage flyback topology, constant turn-on time and constant frequency in Discontinuous Conduction Mode (DCM) are the best method to make the input current proportional to the input voltage as shown in Figure 19. FL7734 basically adopts the DCM operation with constant turn-on and frequency in a half line cycle. Once dimmer absence is detected during startup sequence, FL7734 selects voltage mode in which constant turn-on time is maintained by an internal error amplifier and a large external capacitor (typically $>1 \mu\text{F}$) at the FB pin. Constant frequency and DCM operation are managed by linear frequency control.

Linear Frequency Control

DCM should be guaranteed for high power factor in flyback topology. To maintain DCM in the wide range of output voltage, frequency is linearly adjusted by output voltage in linear frequency control. Output voltage is detected by auxiliary winding and resistive divider connected to the VS pin, as shown in Figure 20. When output voltage decreases, secondary diode conduction time is increased and the linear frequency control lengthens switching period, which retains DCM operation in the wide output voltage range. The frequency control lowers primary rms current for better power efficiency in full-load condition.

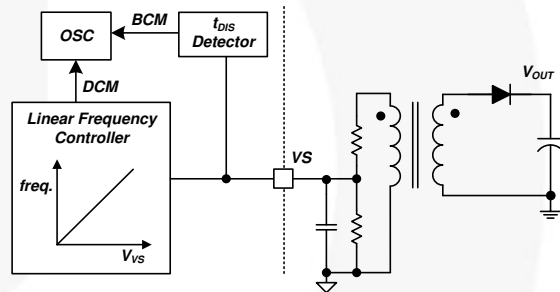

Figure 20. Linear Frequency Control

BCM Control

The end of secondary diode conduction time (t_{DIS}) can be over a switching period set by linear frequency control. In this case, FL7734 doesn't allow CCM and operation mode changes from DCM to BCM. Therefore, magnetizing inductance can be largely designed to add BCM for better efficiency if PF and THD meet specification with enough margin.

Short-LED Protection

In a short-LED condition, the switching MOSFET and secondary diode are usually stressed by the high powering current.

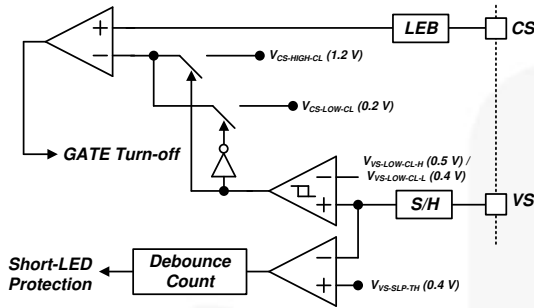

Figure 21. Short LED Protection

FL7734 changes the current-limit level in a short-LED condition. When sampled VS voltage is lower than $V_{VS-LOW-CL-L}$ (0.4 V), the current-limit level is reduced to 0.2 V from 1.2 V, as shown in Figure 21 so that powering is limited and external components' current stress is relieved. When the sampled VS voltage is continuously lower than $V_{VS-SLP-TH}$ (0.4 V) for 3 consecutive switching cycles, short-LED protection is triggered with gate shutdown. After all types of protection including short-LED protection is triggered, FL7734 internally counts 4 seconds for auto restart and begins startup sequence again.

Open-LED Protection

When output load is open as high impedance, the output capacitor should be protected by limiting the capacitor voltage less than its maximum rating. FL7734 can detect the output over-voltage condition by sensing both VDD and VS voltages. When VDD voltage is higher than V_{DD-OVP} (27 V typical) or sampled VS voltage is higher than V_{VS-OVP} (3 V typical), protection is triggered. The protection mode is auto restart so normal operation resumes when the fault condition is removed.

Sensing Resistor Short Protection

During SS3, the controller operates in current-mode control and the peak CS voltage is 0.2 V during switching mode. When a sensing resistor is short circuited, CS voltage cannot reach 0.2 V and turn on time is maximized with potential damage of switching MOSFET. In order to provide protection against the failure, FL7734 compares CS voltage with $V_{CS-SRSP}$ (0.1 V) during the initial two switching operation. When VCS doesn't reach 0.1 V for the two switching, Sensing Resistor Short Protection (SRSP) is triggered. In normal condition, input voltage corresponding to 1.5 V V_{VIN} is high enough to make V_{CS} higher than 0.1 V with turn-on time shorter than maximum turn-on time.

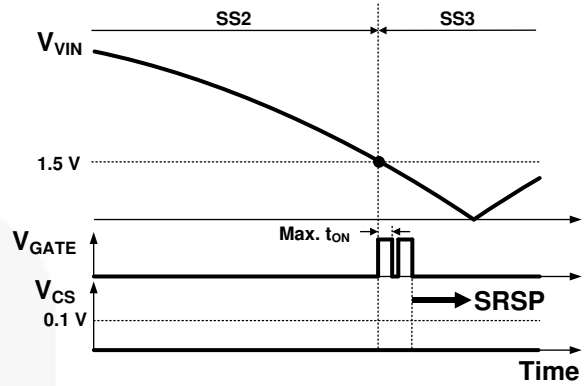

Figure 22. Sensing Resistor Short Protection

Under-Voltage Lockout (UVLO)

The turn-on and turn-off thresholds are fixed internally at 10.6 V and 7.75 V, respectively. During startup, the VDD capacitor must be charged higher than 10.6 V through the external bleeding MOSFET. The bleeding MOSFET supplies VDD operating current until power can be delivered from the auxiliary winding of the main transformer. Generally at small phase angle range, V_{DD} supply time from auxiliary winding is short and V_{DD} could reach to V_{DD-OFF} (7.75 V). If V_{DD} drops below V_{DD-OFF} , VDD hiccup occurs with a certain hiccup frequency determined by VDD capacitor value and VDD supply current from auxiliary winding. This hiccup mode could cause LED flicker. In order to remove the unstable mode of operation, external bleeding circuit never allows V_{DD} voltage to fall down less than V_{DD-OFF} (7.75 V) once input power is supplied.

Over-Temperature Protection (OTP)

The built-in temperature-sensing circuit shuts down PWM output if the junction temperature exceeds 150°C. After Over-Temperature Protection (OTP) is triggered, FL7734 repeats auto-restart time counting until the junction temperature is lowered less than 140°C. Different from Short/Open-LED protection and SRSP, startup sequence doesn't appear every 4 seconds of auto-restart delay time because the temperature is detected by monitoring internally, not by checking external pin information. Normal startup sequence is started again when the junction temperature is out of the hysteresis temperature (140°C).

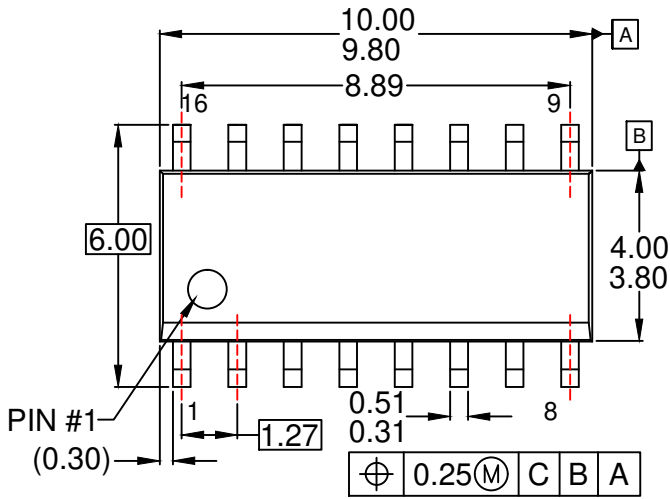

TOP VIEW

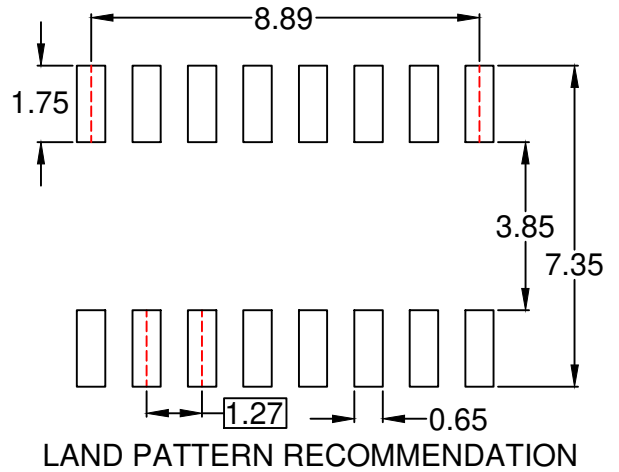

LAND PATTERN RECOMMENDATION

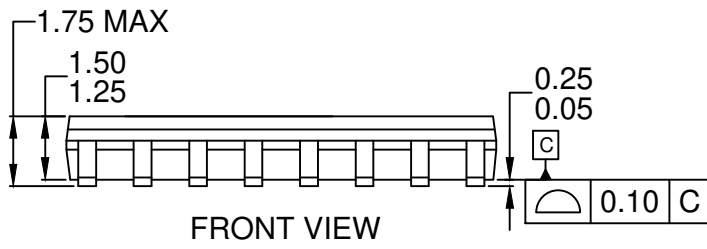

FRONT VIEW

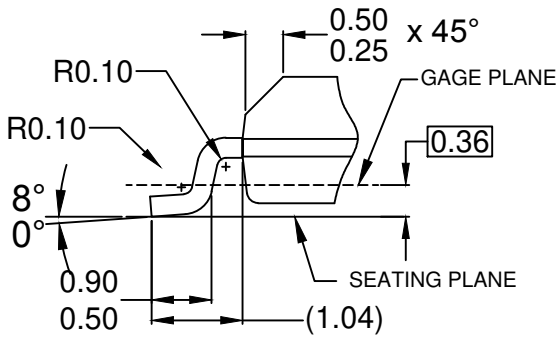
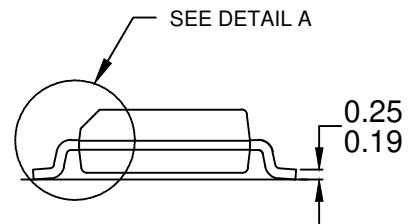

DETAIL A
SCALE: 2:1

NOTES:

- A) THIS PACKAGE CONFORMS TO JEDEC MS-012, VARIATION AC, ISSUE C.
- B) ALL DIMENSIONS ARE IN MILLIMETERS.
- C) DIMENSIONS ARE EXCLUSIVE OF BURRS, MOLD FLASH AND TIE BAR PROTRUSIONS
- D) CONFORMS TO ASME Y14.5M-2009
- E) LANDPATTERN STANDARD:
SOIC127P600X175-16AM
- F) DRAWING FILE NAME: M16AREV13.



ON Semiconductor and  are trademarks of Semiconductor Components Industries, LLC dba ON Semiconductor or its subsidiaries in the United States and/or other countries. ON Semiconductor owns the rights to a number of patents, trademarks, copyrights, trade secrets, and other intellectual property. A listing of ON Semiconductor's product/patent coverage may be accessed at www.onsemi.com/site/pdf/Patent-Marking.pdf. ON Semiconductor reserves the right to make changes without further notice to any products herein. ON Semiconductor makes no warranty, representation or guarantee regarding the suitability of its products for any particular purpose, nor does ON Semiconductor assume any liability arising out of the application or use of any product or circuit, and specifically disclaims any and all liability, including without limitation special, consequential or incidental damages. Buyer is responsible for its products and applications using ON Semiconductor products, including compliance with all laws, regulations and safety requirements or standards, regardless of any support or applications information provided by ON Semiconductor. "Typical" parameters which may be provided in ON Semiconductor data sheets and/or specifications can and do vary in different applications and actual performance may vary over time. All operating parameters, including "Typicals" must be validated for each customer application by customer's technical experts. ON Semiconductor does not convey any license under its patent rights nor the rights of others. ON Semiconductor products are not designed, intended, or authorized for use as a critical component in life support systems or any FDA Class 3 medical devices or medical devices with a same or similar classification in a foreign jurisdiction or any devices intended for implantation in the human body. Should Buyer purchase or use ON Semiconductor products for any such unintended or unauthorized application, Buyer shall indemnify and hold ON Semiconductor and its officers, employees, subsidiaries, affiliates, and distributors harmless against all claims, costs, damages, and expenses, and reasonable attorney fees arising out of, directly or indirectly, any claim of personal injury or death associated with such unintended or unauthorized use, even if such claim alleges that ON Semiconductor was negligent regarding the design or manufacture of the part. ON Semiconductor is an Equal Opportunity/Affirmative Action Employer. This literature is subject to all applicable copyright laws and is not for resale in any manner.

PUBLICATION ORDERING INFORMATION

LITERATURE FULFILLMENT:

Literature Distribution Center for ON Semiconductor
19521 E. 32nd Pkwy, Aurora, Colorado 80011 USA
Phone: 303-675-2175 or 800-344-3860 Toll Free USA/Canada
Fax: 303-675-2176 or 800-344-3867 Toll Free USA/Canada
Email: orderlit@onsemi.com

N. American Technical Support: 800-282-9855 Toll Free
USA/Canada
Europe, Middle East and Africa Technical Support:
Phone: 421 33 790 2910
Japan Customer Focus Center
Phone: 81-3-5817-1050

ON Semiconductor Website: www.onsemi.com
Order Literature: <http://www.onsemi.com/orderlit>
For additional information, please contact your local
Sales Representative