



Chipsmall Limited consists of a professional team with an average of over 10 year of expertise in the distribution of electronic components. Based in Hongkong, we have already established firm and mutual-benefit business relationships with customers from,Europe,America and south Asia,supplying obsolete and hard-to-find components to meet their specific needs.

With the principle of "Quality Parts,Customers Priority,Honest Operation,and Considerate Service",our business mainly focus on the distribution of electronic components. Line cards we deal with include Microchip,ALPS,ROHM,Xilinx,Pulse,ON,Everlight and Freescale. Main products comprise IC,Modules,Potentiometer,IC Socket,Relay,Connector.Our parts cover such applications as commercial,industrial, and automotives areas.

We are looking forward to setting up business relationship with you and hope to provide you with the best service and solution. Let us make a better world for our industry!



## Contact us

Tel: +86-755-8981 8866 Fax: +86-755-8427 6832

Email & Skype: info@chipsmall.com Web: www.chipsmall.com

Address: A1208, Overseas Decoration Building, #122 Zhenhua RD., Futian, Shenzhen, China





Is Now Part of



**ON Semiconductor®**

To learn more about ON Semiconductor, please visit our website at  
[www.onsemi.com](http://www.onsemi.com)

ON Semiconductor and the ON Semiconductor logo are trademarks of Semiconductor Components Industries, LLC dba ON Semiconductor or its subsidiaries in the United States and/or other countries. ON Semiconductor owns the rights to a number of patents, trademarks, copyrights, trade secrets, and other intellectual property. A listing of ON Semiconductor's product/patent coverage may be accessed at [www.onsemi.com/site/pdf/Patent-Marking.pdf](http://www.onsemi.com/site/pdf/Patent-Marking.pdf). ON Semiconductor reserves the right to make changes without further notice to any products herein. ON Semiconductor makes no warranty, representation or guarantee regarding the suitability of its products for any particular purpose, nor does ON Semiconductor assume any liability arising out of the application or use of any product or circuit, and specifically disclaims any and all liability, including without limitation special, consequential or incidental damages. Buyer is responsible for its products and applications using ON Semiconductor products, including compliance with all laws, regulations and safety requirements or standards, regardless of any support or applications information provided by ON Semiconductor. "Typical" parameters which may be provided in ON Semiconductor data sheets and/or specifications can and do vary in different applications and actual performance may vary over time. All operating parameters, including "Typicals" must be validated for each customer application by customer's technical experts. ON Semiconductor does not convey any license under its patent rights nor the rights of others. ON Semiconductor products are not designed, intended, or authorized for use as a critical component in life support systems or any FDA Class 3 medical devices or medical devices with a same or similar classification in a foreign jurisdiction or any devices intended for implantation in the human body. Should Buyer purchase or use ON Semiconductor products for any such unintended or unauthorized application, Buyer shall indemnify and hold ON Semiconductor and its officers, employees, subsidiaries, affiliates, and distributors harmless against all claims, costs, damages, and expenses, and reasonable attorney fees arising out of, directly or indirectly, any claim of personal injury or death associated with such unintended or unauthorized use, even if such claim alleges that ON Semiconductor was negligent regarding the design or manufacture of the part. ON Semiconductor is an Equal Opportunity/Affirmative Action Employer. This literature is subject to all applicable copyright laws and is not for resale in any manner.



March 2016

# FFA40UP35S

## 40 A, 350 V Ultrafast Diode



FFA40UP35S – Ultrafast Diode

### Features

- Ultrafast Recovery,  $t_{rr} < 55 \text{ ns}$  (@  $I_F = 40 \text{ A}$ )
- Max. Forward Voltage,  $V_F = 1.6 \text{ V}$  ( $T_C = 25^\circ\text{C}$ )
- Reverse Voltage:  $V_{RRM} = 350 \text{ V}$
- Avalanche Energy Rated
- RoHS Compliant

### Description

The FFA40UP35S is an ultrafast diode with low forward voltage drop and rugged UIS capability. This device is intended for use as freewheeling and clamping diodes in a variety of switching power supplies and other power switching applications. It is specially suited for use in switching power supplies and industrial applications as welder and UPS application.

### Applications

- General Purpose
- SMPS, Free-Wheeling Diode for Motor Application
- Power Switching Circuits, Welder, UPS

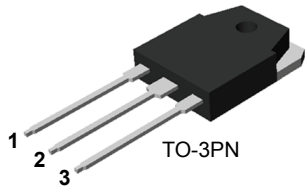

1. Anode 2. Cathode 3. Anode

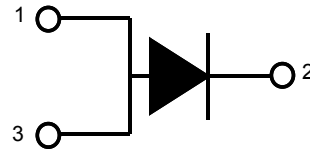

1. Anode 2. Cathode 3. Anode

### Absolute Maximum Ratings $T_C = 25^\circ\text{C}$ unless otherwise noted

Symbol	Parameter	Ratings	Unit
$V_{RRM}$	Peak Repetitive Reverse Voltage	350	V
$V_{RWM}$	Working Peak Reverse Voltage	350	V
$V_R$	DC Blocking Voltage	350	V
$I_{F(AV)}$	Average Rectified Forward Current @ $T_C = 125^\circ\text{C}$	40	A
$I_{FSM}$	Non-repetitive Peak Surge Current 60Hz Single Half-Sine Wave	300	A
$T_J, T_{STG}$	Operating and Storage Temperature Range	-65 to +175	$^\circ\text{C}$

### Thermal Characteristics

Symbol	Parameter	Ratings	Unit
$R_{\theta JC}$	Maximum Thermal Resistance, Junction to Case	0.8	$^\circ\text{C/W}$

### Package Marking and Ordering Information

Part Number	Top Mark	Package	Packing Method	Reel Size	Tape Width	Quantity
FFA40UP35STU	F40UP35S	TO-3P	Tube	N/A	N/A	30

### Electrical Characteristics $T_C = 25^\circ\text{C}$ unless otherwise noted

Symbol	Parameter	Min.	Typ.	Max.	Unit
$V_{F1}$	$I_F = 40\text{ A}$ $I_F = 40\text{ A}$	$T_C = 25^\circ\text{C}$ $T_C = 125^\circ\text{C}$	- -	1.6 1.5	V
$I_{R1}$	$V_R = 350\text{ V}$ $V_R = 350\text{ V}$	$T_C = 25^\circ\text{C}$ $T_C = 125^\circ\text{C}$	- -	100 500	$\mu\text{A}$
$t_{rr}$	$I_F = 1\text{ A}$ , $di_F/dt = 100\text{ A}/\mu\text{s}$ , $V_R = 30\text{ V}$ $I_F = 40\text{ A}$ , $di_F/dt = 200\text{ A}/\mu\text{s}$ , $V_R = 230\text{ V}$	$T_C = 25^\circ\text{C}$	- 26 28	53 55	ns
$t_a$ $t_b$ $Q_{rr}$	$I_F = 40\text{ A}$ , $di_F/dt = 200\text{ A}/\mu\text{s}$ , $V_R = 230\text{ V}$	$T_C = 25^\circ\text{C}$	- - 36	- - -	ns ns nC
$W_{AVL}$	Avalanche Energy ( $L = 40\text{ mH}$ )	20	-	-	mJ

**Notes:**

1: Pulse: Test Pulse width = 300 $\mu\text{s}$ , Duty Cycle = 2%

### Test Circuit and Waveforms

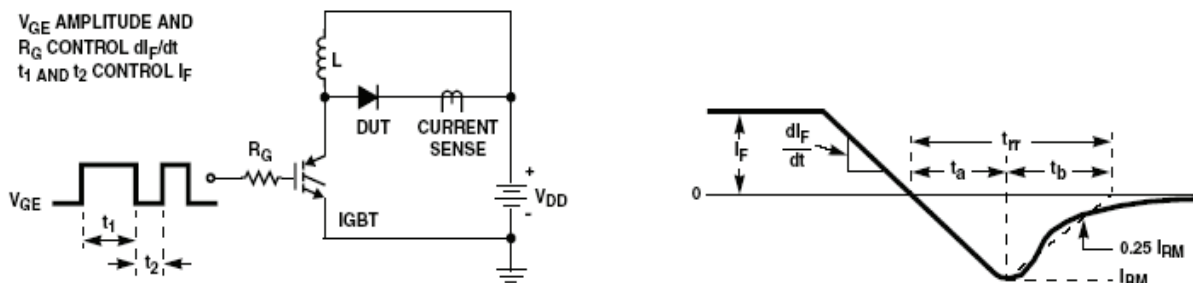

Figure 1. Diode Reverse Recovery Test Circuit & Waveform

$L = 40\text{mH}$   
 $R < 0.1\Omega$   
 $V_{DD} = 50\text{V}$

$E_{AVL} = 1/2LI^2 [V_{R(AVL)}/(V_{R(AVL)} - V_{DD})]$   
 $Q1 = \text{IGBT } (BV_{CES} > \text{DUT } V_{R(AVL)})$

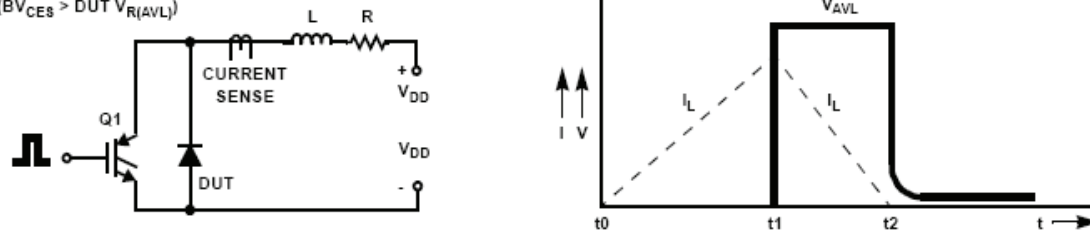

Figure 2. Unclamped Inductive Switching Test Circuit & Waveform

### Typical Performance Characteristics

Figure 3. Typical Forward Voltage Drop vs. Forward Current

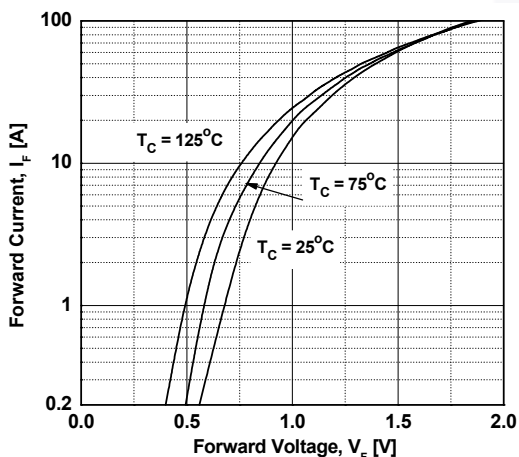

Figure 4. Typical Reverse Current vs. Reverse Voltage

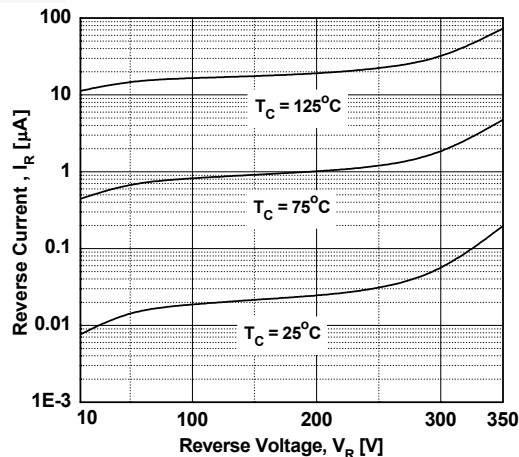

Figure 5. Typical Junction Capacitance

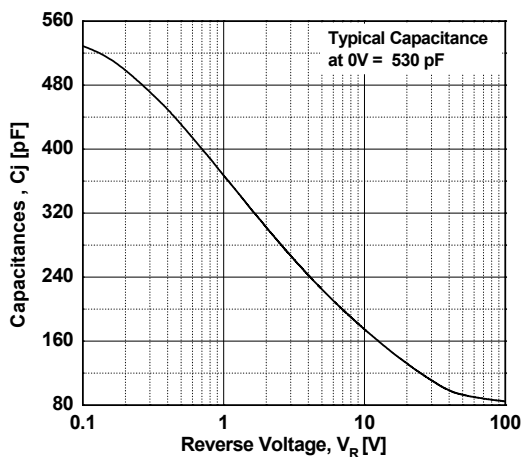

Figure 6. Typical Reverse Recovery Time vs.  $di_F/dt$

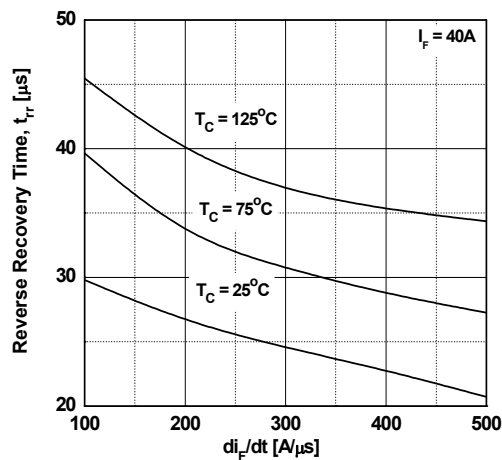

Figure 7. Typical Reverse Recovery Current vs.  $di_F/dt$

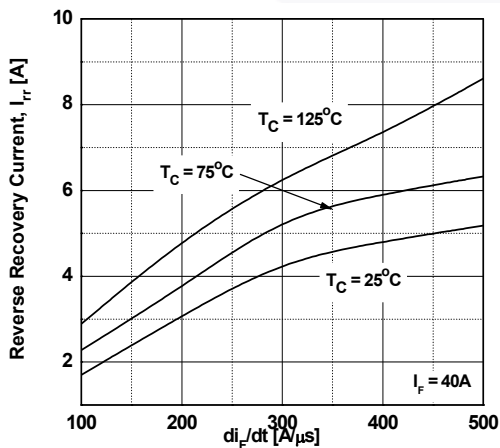
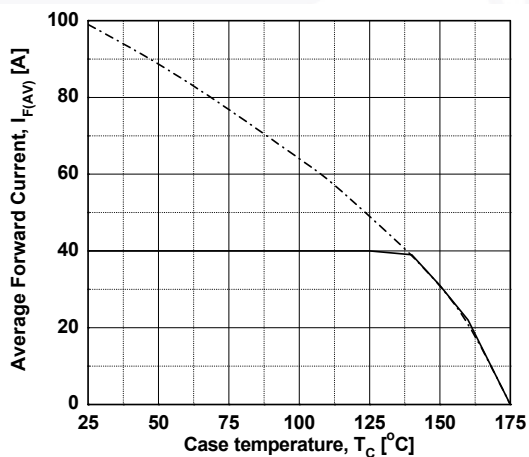
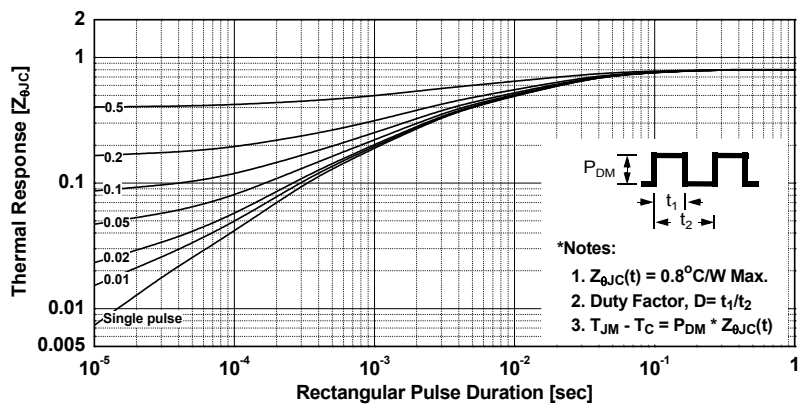

Figure 8. Forward Current Derating Curve



Typical Performance Characteristics (Continued)

Figure 9. Transient Thermal Response Curve



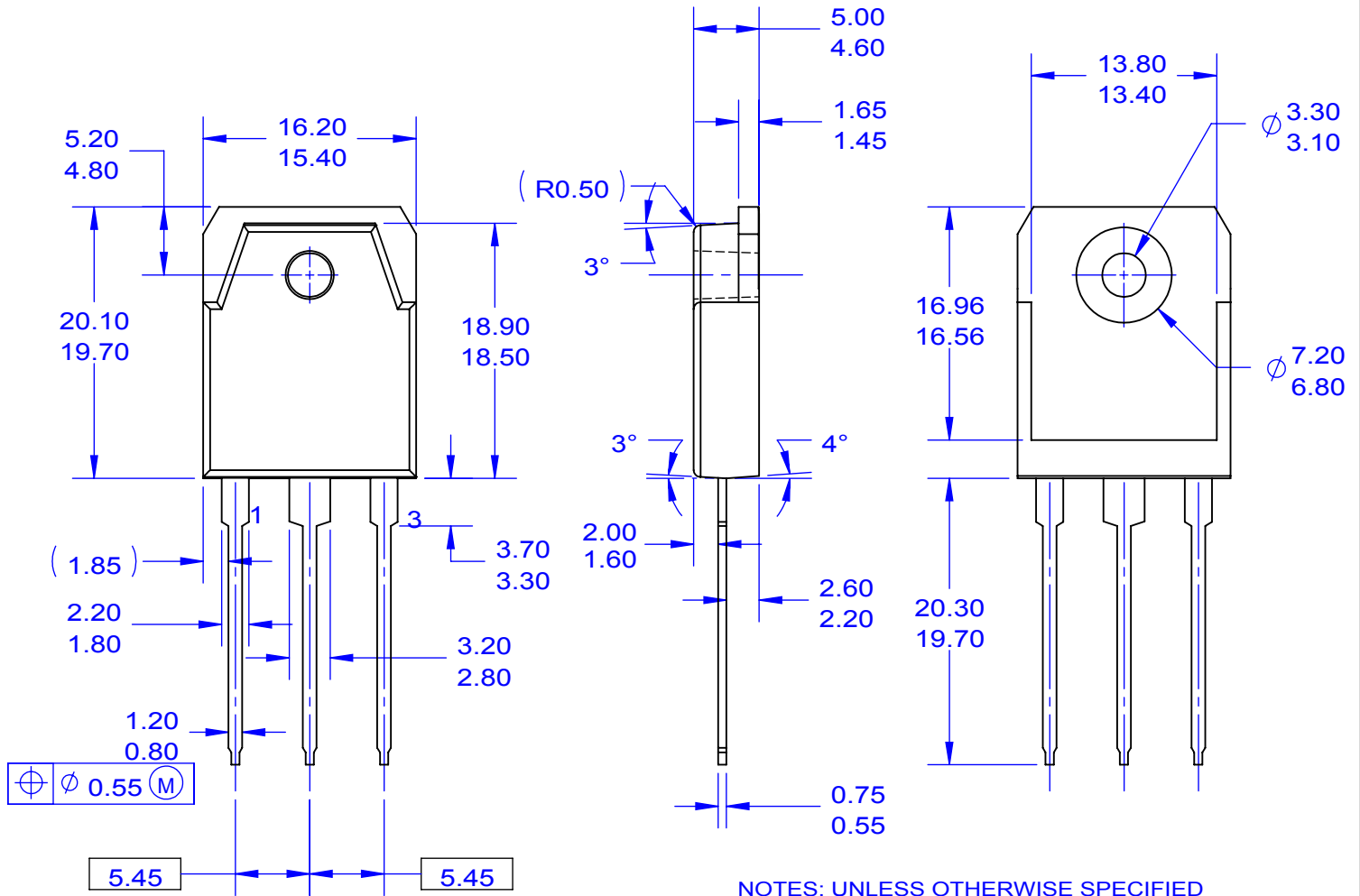

NOTES: UNLESS OTHERWISE SPECIFIED

- A) THIS PACKAGE CONFORMS TO EIAJ SC-65 PACKAGING STANDARD.
- B) ALL DIMENSIONS ARE IN MILLIMETERS.
- C) DIMENSION AND TOLERANCING PER ASME14.5-2009.
- D) DIMENSIONS ARE EXCLUSIVE OF BURRS, MOLD FLASH, AND TIE BAR EXTRUSIONS.
- E) DRAWING FILE NAME: TO3PN03AREV2.
- F) FAIRCHILD SEMICONDUCTOR.

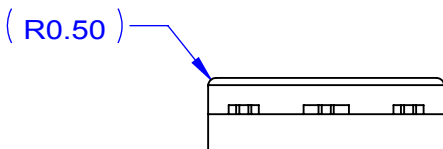

ON Semiconductor and  are trademarks of Semiconductor Components Industries, LLC dba ON Semiconductor or its subsidiaries in the United States and/or other countries. ON Semiconductor owns the rights to a number of patents, trademarks, copyrights, trade secrets, and other intellectual property. A listing of ON Semiconductor's product/patent coverage may be accessed at [www.onsemi.com/site/pdf/Patent-Marking.pdf](http://www.onsemi.com/site/pdf/Patent-Marking.pdf). ON Semiconductor reserves the right to make changes without further notice to any products herein. ON Semiconductor makes no warranty, representation or guarantee regarding the suitability of its products for any particular purpose, nor does ON Semiconductor assume any liability arising out of the application or use of any product or circuit, and specifically disclaims any and all liability, including without limitation special, consequential or incidental damages. Buyer is responsible for its products and applications using ON Semiconductor products, including compliance with all laws, regulations and safety requirements or standards, regardless of any support or applications information provided by ON Semiconductor. "Typical" parameters which may be provided in ON Semiconductor data sheets and/or specifications can and do vary in different applications and actual performance may vary over time. All operating parameters, including "Typicals" must be validated for each customer application by customer's technical experts. ON Semiconductor does not convey any license under its patent rights nor the rights of others. ON Semiconductor products are not designed, intended, or authorized for use as a critical component in life support systems or any FDA Class 3 medical devices or medical devices with a same or similar classification in a foreign jurisdiction or any devices intended for implantation in the human body. Should Buyer purchase or use ON Semiconductor products for any such unintended or unauthorized application, Buyer shall indemnify and hold ON Semiconductor and its officers, employees, subsidiaries, affiliates, and distributors harmless against all claims, costs, damages, and expenses, and reasonable attorney fees arising out of, directly or indirectly, any claim of personal injury or death associated with such unintended or unauthorized use, even if such claim alleges that ON Semiconductor was negligent regarding the design or manufacture of the part. ON Semiconductor is an Equal Opportunity/Affirmative Action Employer. This literature is subject to all applicable copyright laws and is not for resale in any manner.

## PUBLICATION ORDERING INFORMATION

### LITERATURE FULFILLMENT:

Literature Distribution Center for ON Semiconductor  
19521 E. 32nd Pkwy, Aurora, Colorado 80011 USA  
**Phone:** 303-675-2175 or 800-344-3860 Toll Free USA/Canada  
**Fax:** 303-675-2176 or 800-344-3867 Toll Free USA/Canada  
**Email:** [orderlit@onsemi.com](mailto:orderlit@onsemi.com)

**N. American Technical Support:** 800-282-9855 Toll Free  
USA/Canada  
**Europe, Middle East and Africa Technical Support:**  
Phone: 421 33 790 2910  
**Japan Customer Focus Center**  
Phone: 81-3-5817-1050

**ON Semiconductor Website:** [www.onsemi.com](http://www.onsemi.com)  
**Order Literature:** <http://www.onsemi.com/orderlit>  
For additional information, please contact your local  
Sales Representative