



Chipsmall Limited consists of a professional team with an average of over 10 year of expertise in the distribution of electronic components. Based in Hongkong, we have already established firm and mutual-benefit business relationships with customers from,Europe,America and south Asia,supplying obsolete and hard-to-find components to meet their specific needs.

With the principle of “Quality Parts,Customers Priority,Honest Operation,and Considerate Service”,our business mainly focus on the distribution of electronic components. Line cards we deal with include Microchip,ALPS,ROHM,Xilinx,Pulse,ON,Everlight and Freescale. Main products comprise IC,Modules,Potentiometer,IC Socket,Relay,Connector.Our parts cover such applications as commercial,industrial, and automotives areas.

We are looking forward to setting up business relationship with you and hope to provide you with the best service and solution. Let us make a better world for our industry!



Contact us

Tel: +86-755-8981 8866 Fax: +86-755-8427 6832

Email & Skype: info@chipsmall.com Web: www.chipsmall.com

Address: A1208, Overseas Decoration Building, #122 Zhenhua RD., Futian, Shenzhen, China





Is Now Part of



ON Semiconductor®

To learn more about ON Semiconductor, please visit our website at
www.onsemi.com

ON Semiconductor and the ON Semiconductor logo are trademarks of Semiconductor Components Industries, LLC dba ON Semiconductor or its subsidiaries in the United States and/or other countries. ON Semiconductor owns the rights to a number of patents, trademarks, copyrights, trade secrets, and other intellectual property. A listing of ON Semiconductor's product/patent coverage may be accessed at www.onsemi.com/site/pdf/Patent-Marking.pdf. ON Semiconductor reserves the right to make changes without further notice to any products herein. ON Semiconductor makes no warranty, representation or guarantee regarding the suitability of its products for any particular purpose, nor does ON Semiconductor assume any liability arising out of the application or use of any product or circuit, and specifically disclaims any and all liability, including without limitation special, consequential or incidental damages. Buyer is responsible for its products and applications using ON Semiconductor products, including compliance with all laws, regulations and safety requirements or standards, regardless of any support or applications information provided by ON Semiconductor. "Typical" parameters which may be provided in ON Semiconductor data sheets and/or specifications can and do vary in different applications and actual performance may vary over time. All operating parameters, including "Typicals" must be validated for each customer application by customer's technical experts. ON Semiconductor does not convey any license under its patent rights nor the rights of others. ON Semiconductor products are not designed, intended, or authorized for use as a critical component in life support systems or any FDA Class 3 medical devices or medical devices with a same or similar classification in a foreign jurisdiction or any devices intended for implantation in the human body. Should Buyer purchase or use ON Semiconductor products for any such unintended or unauthorized application, Buyer shall indemnify and hold ON Semiconductor and its officers, employees, subsidiaries, affiliates, and distributors harmless against all claims, costs, damages, and expenses, and reasonable attorney fees arising out of, directly or indirectly, any claim of personal injury or death associated with such unintended or unauthorized use, even if such claim alleges that ON Semiconductor was negligent regarding the design or manufacture of the part. ON Semiconductor is an Equal Opportunity/Affirmative Action Employer. This literature is subject to all applicable copyright laws and is not for resale in any manner.



October 2016

FFSH20120ADN_F155 Silicon Carbide Schottky Diode 1200 V, 20 A

Features

- Max Junction Temperature 175 °C
- Avalanche Rated 100 mJ
- High Surge Current Capacity
- Positive Temperature Coefficient
- Ease of Paralleling
- No Reverse Recovery / No Forward Recovery

Applications

- General Purpose
- SMPS, Solar Inverter, UPS
- Power Switching Circuits

Description

Silicon Carbide (SiC) Schottky Diodes use a completely new technology that provides superior switching performance and higher reliability compared to Silicon. No reverse recovery current, temperature independent switching characteristics, and excellent thermal performance sets Silicon Carbide as the next generation of power semiconductor. System benefits include highest efficiency, faster operating frequency, increased power density, reduced EMI, and reduced system size and cost.

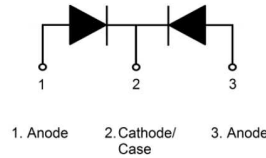
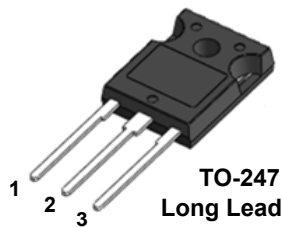

Absolute Maximum Ratings $T_C = 25\text{ }^\circ\text{C}$ unless otherwise noted. (per leg)

Symbol	Parameter	Ratings	Unit	
V_{RRM}	Peak Repetitive Reverse Voltage	1200	V	
E_{AS}	Single Pulse Avalanche Energy (Note 1)	100	mJ	
I_F	Continuous Rectified Forward Current @ $T_C < 148\text{ }^\circ\text{C}$	10^* / 20^{**}	A	
$I_{F, Max}$	Non-Repetitive Peak Forward Surge Current	$T_C = 25\text{ }^\circ\text{C}$, 10 μs	630	A
		$T_C = 150\text{ }^\circ\text{C}$, 10 μs	560	A
$I_{F, SM}$	Non-Repetitive Forward Surge Current	Half-Sine Pulse, $t_p = 8.3\text{ ms}$	96	A
$I_{F, RM}$	Repetitive Forward Surge Current	Half-Sine Pulse, $t_p = 8.3\text{ ms}$	46	A
P_{tot}	Power Dissipation	$T_C = 25\text{ }^\circ\text{C}$	150	W
		$T_C = 150\text{ }^\circ\text{C}$	25	W
T_J, T_{STG}	Operating and Storage Temperature Range	-55 to +175	$^\circ\text{C}$	
	TO247 Mounting Torque, M3 Screw	60	Ncm	

Thermal Characteristic

Symbol	Parameter	Ratings	Unit
$R_{\theta JC}$	Thermal Resistance, Junction to Case, Max	1^* / 0.44^{**}	$^\circ\text{C/W}$

* Per leg, ** Per Device

FFSH20120ADN_F155 — Silicon Carbide Schottky Diode

Package Marking and Ordering Information

Part Number	Top Mark	Package	Packing Method	Reel Size	Tape Width	Quantity
FFSH20120ADN_F155	FFSH20120ADN	TO-247 Long Lead	Tube	N/A	N/A	30 units

Electrical Characteristics $T_C = 25^\circ\text{C}$ unless otherwise noted. (per leg)

Symbol	Parameter	Test Conditions	Min.	Typ.	Max.	Unit
V_F	Forward Voltage	$I_F = 10\text{ A}, T_C = 25^\circ\text{C}$	-	1.45	1.75	V
		$I_F = 10\text{ A}, T_C = 125^\circ\text{C}$	-	1.7	2	
		$I_F = 10\text{ A}, T_C = 175^\circ\text{C}$	-	2	2.4	
I_R	Reverse Current	$V_R = 1200\text{ V}, T_C = 25^\circ\text{C}$	-	-	200	μA
		$V_R = 1200\text{ V}, T_C = 125^\circ\text{C}$	-	-	300	
		$V_R = 1200\text{ V}, T_C = 175^\circ\text{C}$	-	-	400	
Q_C	Total Capacitive Charge	$V = 800\text{ V}$	-	62	-	nC
C	Total Capacitance	$V_R = 1\text{ V}, f = 100\text{ kHz}$	-	612	-	pF
		$V_R = 400\text{ V}, f = 100\text{ kHz}$	-	58	-	
		$V_R = 800\text{ V}, f = 100\text{ kHz}$	-	47	-	

Notes:

1: EAS of 100 mJ is based on starting $T_J = 25^\circ\text{C}$, $L = 0.5\text{ mH}$, $I_{AS} = 20\text{ A}$, $V = 150\text{ V}$.

Typical Characteristics $T_J = 25^\circ\text{C}$ unless otherwise noted (per leg).

Figure 1. Forward Characteristics

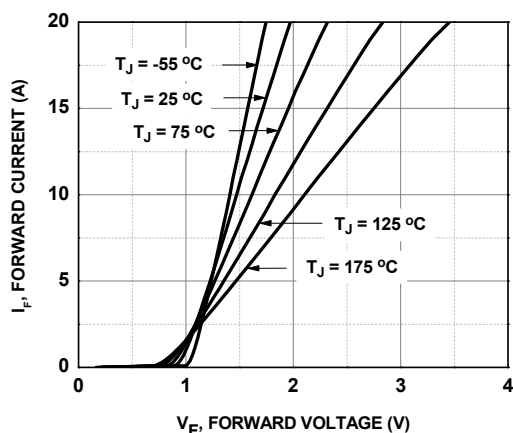

Figure 2. Reverse Characteristics

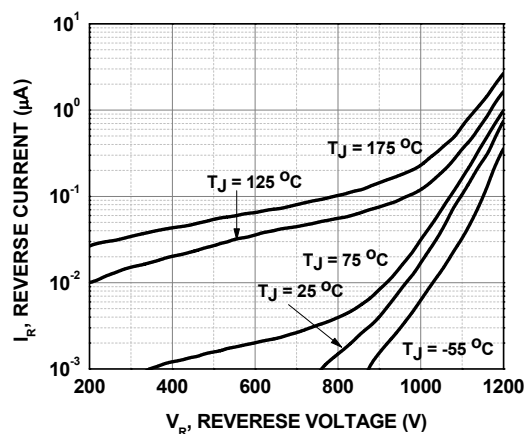

Figure 3. Reverse Characteristics

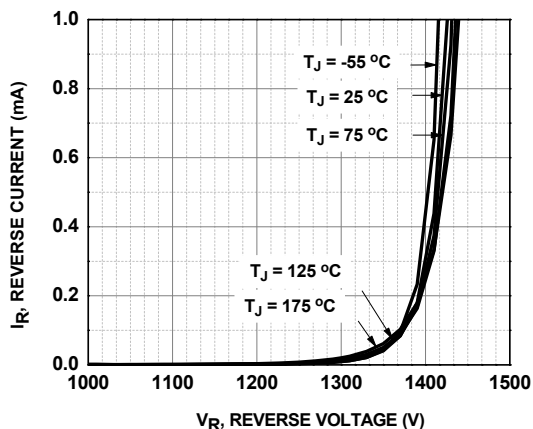
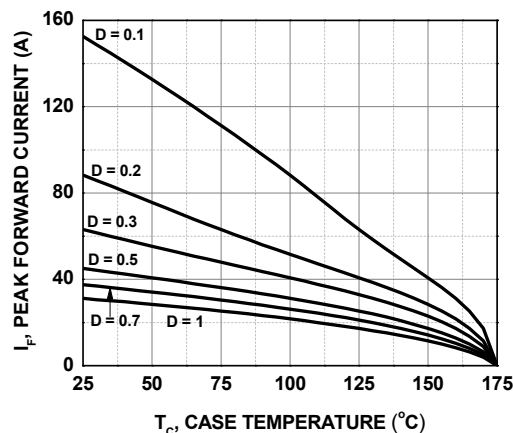

Figure 4. Current Derating



Typical Characteristics $T_J = 25\text{ }^\circ\text{C}$ unless otherwise noted (per leg, continue).

Figure 5. Power Derating

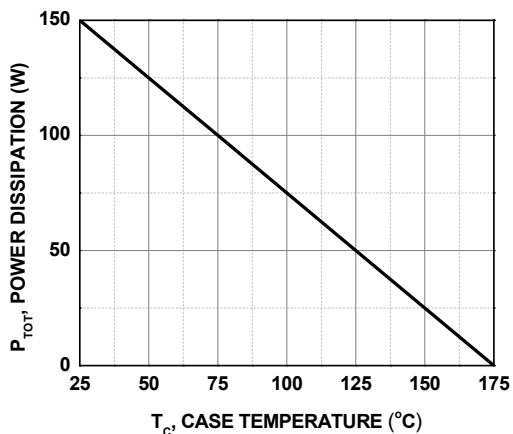

Figure 6. Capacitive Charge vs. Reverse Voltage

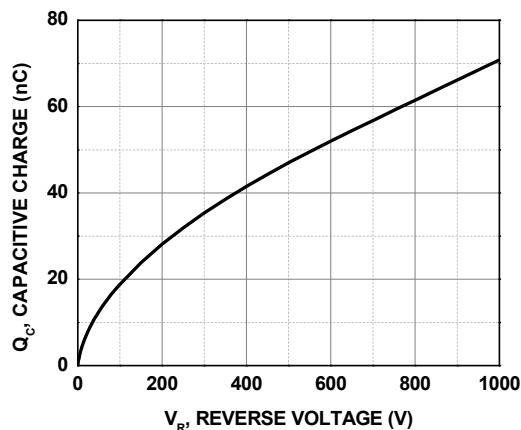

Figure 7. Capacitance vs. Reverse Voltage

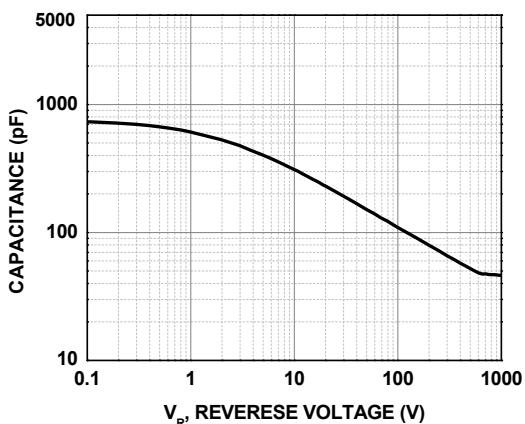

Figure 8. Capacitance Stored Energy

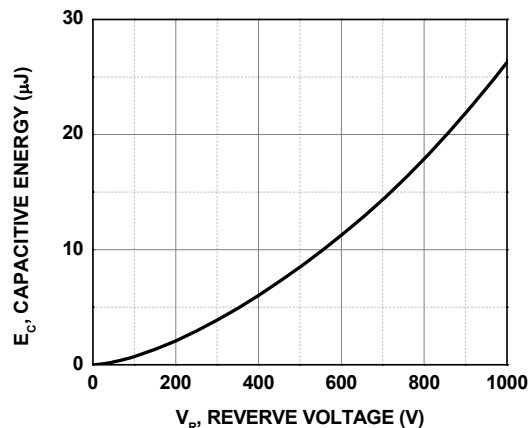
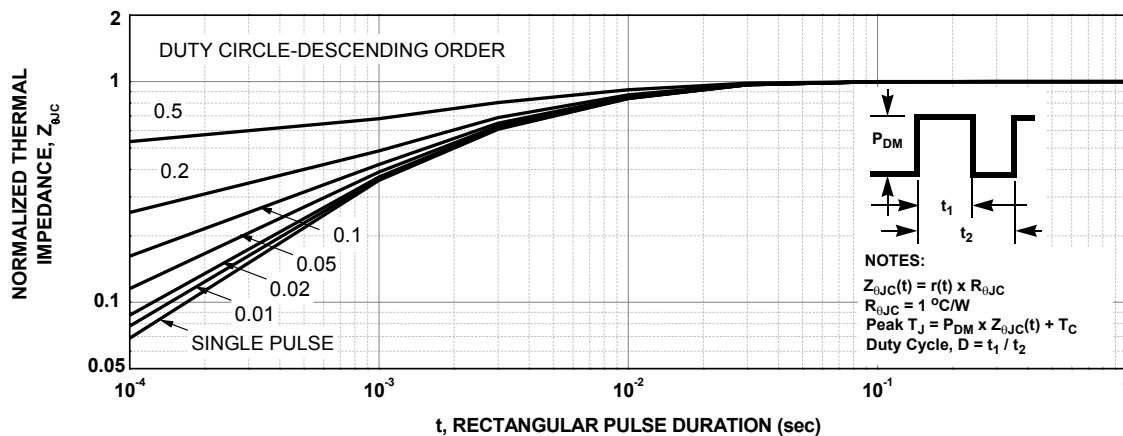

Figure 9. Junction-to-Case Transient Thermal Response Curve



Test Circuit and Waveforms

Figure 10. Unclamped Inductive Switching Test Circuit & Waveform

L = 0.5mH
 R < 0.1Ω
 V_{DD} = 50V
 $E_{AVL} = 1/2 L I^2 [V_{R(AVL)} / (V_{R(AVL)} - V_{DD})]$
 Q1 = IGBT (BV_{CES} > DUT V_{R(AVL)})

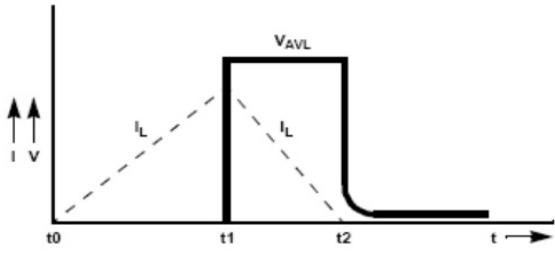
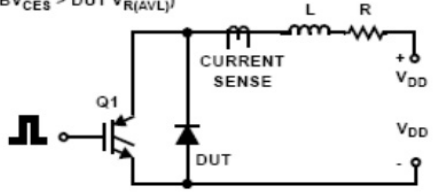

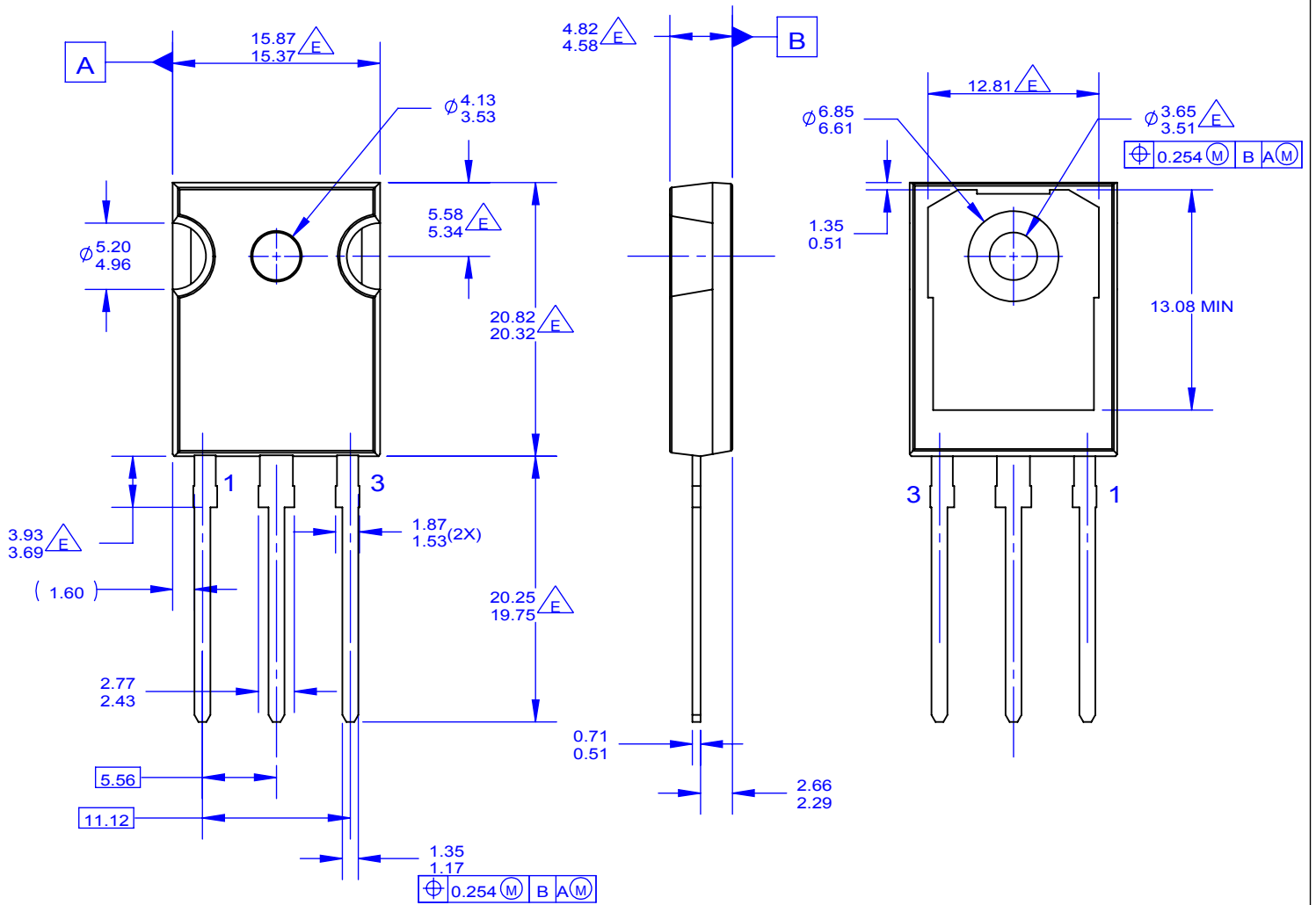

NOTES: UNLESS OTHERWISE SPECIFIED.

- A. PACKAGE REFERENCE: JEDEC TO-247, ISSUE E, VARIATION AB, DATED JUNE, 2004.
- B. DIMENSIONS ARE EXCLUSIVE OF BURRS, MOLD FLASH, AND TIE BAR EXTRUSIONS.
- C. ALL DIMENSIONS ARE IN MILLIMETERS.
- D. DRAWING CONFORMS TO ASME Y14.5 - 1994

$\triangle E$ DOES NOT COMPLY JEDEC STANDARD VALUE
 F. DRAWING FILENAME: MKT-TO247G03_REV02



ON Semiconductor and  are trademarks of Semiconductor Components Industries, LLC dba ON Semiconductor or its subsidiaries in the United States and/or other countries. ON Semiconductor owns the rights to a number of patents, trademarks, copyrights, trade secrets, and other intellectual property. A listing of ON Semiconductor's product/patent coverage may be accessed at www.onsemi.com/site/pdf/Patent-Marking.pdf. ON Semiconductor reserves the right to make changes without further notice to any products herein. ON Semiconductor makes no warranty, representation or guarantee regarding the suitability of its products for any particular purpose, nor does ON Semiconductor assume any liability arising out of the application or use of any product or circuit, and specifically disclaims any and all liability, including without limitation special, consequential or incidental damages. Buyer is responsible for its products and applications using ON Semiconductor products, including compliance with all laws, regulations and safety requirements or standards, regardless of any support or applications information provided by ON Semiconductor. "Typical" parameters which may be provided in ON Semiconductor data sheets and/or specifications can and do vary in different applications and actual performance may vary over time. All operating parameters, including "Typicals" must be validated for each customer application by customer's technical experts. ON Semiconductor does not convey any license under its patent rights nor the rights of others. ON Semiconductor products are not designed, intended, or authorized for use as a critical component in life support systems or any FDA Class 3 medical devices or medical devices with a same or similar classification in a foreign jurisdiction or any devices intended for implantation in the human body. Should Buyer purchase or use ON Semiconductor products for any such unintended or unauthorized application, Buyer shall indemnify and hold ON Semiconductor and its officers, employees, subsidiaries, affiliates, and distributors harmless against all claims, costs, damages, and expenses, and reasonable attorney fees arising out of, directly or indirectly, any claim of personal injury or death associated with such unintended or unauthorized use, even if such claim alleges that ON Semiconductor was negligent regarding the design or manufacture of the part. ON Semiconductor is an Equal Opportunity/Affirmative Action Employer. This literature is subject to all applicable copyright laws and is not for resale in any manner.

PUBLICATION ORDERING INFORMATION

LITERATURE FULFILLMENT:

Literature Distribution Center for ON Semiconductor
19521 E. 32nd Pkwy, Aurora, Colorado 80011 USA
Phone: 303-675-2175 or 800-344-3860 Toll Free USA/Canada
Fax: 303-675-2176 or 800-344-3867 Toll Free USA/Canada
Email: orderlit@onsemi.com

N. American Technical Support: 800-282-9855 Toll Free
USA/Canada
Europe, Middle East and Africa Technical Support:
Phone: 421 33 790 2910
Japan Customer Focus Center
Phone: 81-3-5817-1050

ON Semiconductor Website: www.onsemi.com
Order Literature: <http://www.onsemi.com/orderlit>
For additional information, please contact your local
Sales Representative