



Chipsmall Limited consists of a professional team with an average of over 10 year of expertise in the distribution of electronic components. Based in Hongkong, we have already established firm and mutual-benefit business relationships with customers from,Europe,America and south Asia,supplying obsolete and hard-to-find components to meet their specific needs.

With the principle of “Quality Parts,Customers Priority,Honest Operation,and Considerate Service”,our business mainly focus on the distribution of electronic components. Line cards we deal with include Microchip,ALPS,ROHM,Xilinx,Pulse,ON,Everlight and Freescale. Main products comprise IC,Modules,Potentiometer,IC Socket,Relay,Connector.Our parts cover such applications as commercial,industrial, and automotives areas.

We are looking forward to setting up business relationship with you and hope to provide you with the best service and solution. Let us make a better world for our industry!



Contact us

Tel: +86-755-8981 8866 Fax: +86-755-8427 6832

Email & Skype: info@chipsmall.com Web: www.chipsmall.com

Address: A1208, Overseas Decoration Building, #122 Zhenhua RD., Futian, Shenzhen, China



FGSR12SR6012*A

Data Sheet

3-14.4Vdc Input, 12A, 0.6-5.5Vdc Output

The **Tomodachi** Series of non-isolated dc-dc converters deliver exceptional electrical and thermal performance in DOSA based footprints for Point-of-Load converters. Operating from a 3.0Vdc-14.4Vdc input, these are the converters of choice for Intermediate Bus Architecture (IBA) and Distributed Power Architecture applications that require high efficiency, tight regulation, and high reliability in elevated temperature environments with low airflow. The Tunable Loop™ feature allows the user to optimize the dynamic response of the converter to match the load with reduced amount of output capacitance leading to savings on cost and PWB area.

The **FGSR12SR6012*A** converter of the **Tomodachi** Series delivers 12A of output current at a tightly regulated programmable output voltage of 0.6Vdc to 5.5Vdc. The thermal performance of the **FGSR12SR6012*A** is best-in-class: Little derating is needed up to 85°C, under natural convection.

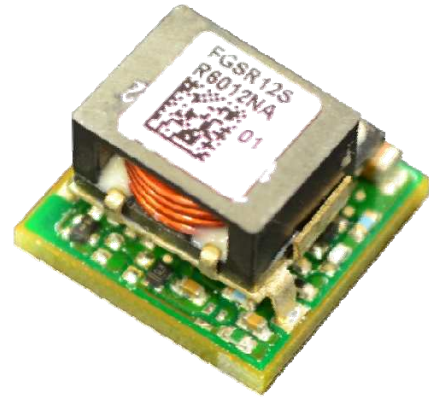

Applications

- Intermediate Bus Architecture
- Telecommunications
- Data/Voice processing
- Distributed Power Architecture
- Computing (Servers, Workstations)
- Test Equipment

Features

- Compliant to RoHS EU Directive 2011/65/EU
- Delivers up to 12A (66W)
- High efficiency, no heatsink required
- Negative and Positive ON/OFF logic
- DOSA based
- Small size: 12.2 x 12.2 x 8.5mm (0.48 in x 0.48 in x 0.335 in)
- Tape & reel packaging
- Programmable output voltage from 0.6V to 5.5V via external resistor
- Tunable Loop™ to optimize dynamic output voltage response
- Power Good signal
- Fixed switching frequency
- Output over-current protection (non-latching)
- Over temperature protection
- Remote ON/OFF
- Ability to sink and source current
- No minimum load required
- Start up into pre-biased output
- *UL** 60950-1 2nd Ed. Recognized, *CSA*† C22.2 No. 60950-1-07 Certified, and *VDE*‡ (EN60950-1 2nd Ed.) Licensed (Pending)
- ISO** 9001 and ISO 14001 certified manufacturing facilities

* *UL* is a registered trademark of Underwriters Laboratories, Inc.

† *CSA* is a registered trademark of Canadian Standards Association.

‡ *VDE* is a trademark of Verband Deutscher Elektrotechniker e.V.

** ISO is a registered trademark of the International Organization of Standards

FGSR12SR6012*A**Data Sheet**

3-14.4Vdc Input, 12A, 0.6-5.5Vdc Output

Absolute Maximum Ratings

Stresses in excess of the absolute maximum ratings may lead to degradation in performance and reliability of the converter and may result in permanent damage.

PARAMETER	NOTES	MIN	TYP	MAX	UNITS
ABSOLUTE MAXIMUM RATINGS¹					
Input Voltage	Continuous	-0.3		15	Vdc
Operating Temperature	Ambient temperature	-40		85	°C
Storage Temperature		-55		125	°C
Output Voltage		0.6		5.5	Vdc

Electrical Specifications

All specifications apply over specified input voltage, output load, and temperature range, unless otherwise noted.

PARAMETER	NOTES	MIN	TYP	MAX	UNITS
INPUT CHARACTERISTICS					
Operating Input Voltage Range		3.0		14.4	Vdc
Maximum Input Current	Vin=4.5V to 14V, Io=Max			12	Adc
Input No Load Current, Vin=12V	Vout=5.0V		75		mA
	Vout=0.6V		45		mA
Input Stand-by Current	Vin=12V, module disabled		0.65		mA
Inrush Transient, I ² t				1	A ² s
Input Reflected-Ripple Current	Peak-to-peak (5Hz to 20MHz, 1uH source impedance; Vin=0 to 14V, Io=12A)		40		mAp-p
Input Ripple Rejection (120Hz)			-60		dB

FGSR12SR6012*A
Data Sheet

3-14.4Vdc Input, 12A, 0.6-5.5Vdc Output

Electrical Specifications (Continued)

PARAMETER	NOTES	MIN	TYP	MAX	UNITS
OUTPUT CHARACTERISTICS					
Output Voltage Set Point (no load)	With 0.1% tolerance for external resistor used to set output voltage	-1.0		+1.0	%Vout
Output Voltage Range	(Over all operating input voltage, resistive load and temperature conditions until end of life)	-3.0		+3.0	%Vout
Adjustment Range (selected by an external resistor)	Some output voltages may not be possible depending on the input voltage – see feature description section	0.6		5.5	Vdc
Remote Sense Range				0.5	Vdc
Output Regulation (for $V_o \geq 2.5Vdc$)	Line ($V_{in} = \text{min to max}$)			0.4	%Vout
	Load ($I_o = \text{min to max}$)			10	mV
Output Regulation (for $V_o < 2.5Vdc$)	Line ($V_{in} = \text{min to max}$)			5	mV
	Load ($I_o = \text{min to max}$)			10	mV
	Temperature ($T_a = \text{min to max}$)			0.4	%Vout
Output Ripple and Noise	$V_{in}=12V$, $I_o= \text{min to max}$, $C_o = 0.1\mu F+22\mu F$ ceramic capacitors				
Peak to Peak	5MHz to 20MHz bandwidth		50	100	mVp-p
RMS	5MHz to 20MHz bandwidth		20	38	mVrms
External Load Capacitance ¹	Plus full load (resistive)				%
Without the Tunable Loop	$ESR \geq 1m\Omega$	22		47	μF
With the Tunable Loop	$ESR \geq 0.15m\Omega$	22		1,000	μF
	$ESR \geq 10m\Omega$	22		5,000	μF
Output Current Range	(in either sink or source mode)	0		12	Adc
Output Current Limit Inception (Hiccup mode)	Current limit does not operate in sink mode		200		% $I_o\text{-max}$
Output Short-Circuit Current	$V_o \leq 250mV$, Hiccup mode		1.5		Arms
Efficiency					
$V_{in} = 12Vdc$, $T_a = 25^\circ C$, $I_o = \text{max}$	$V_{out}=5.0Vdc$		95.0		%
	$V_{out}=3.3Vdc$		93.4		%
	$V_{out}=2.5Vdc$		92.4		%
	$V_{out}=1.8Vdc$		89.6		%
	$V_{out}=1.2Vdc$		85.9		%
	$V_{out}=0.6Vdc$		77.5		%
Switching Frequency			600		kHz

¹ External capacitors may require using the new Tunable Loop™ feature to ensure that the module is stable as well as getting the best transient response. See the Tunable Loop™ section for details.

FGSR12SR6012*A

Data Sheet

3-14.4Vdc Input, 12A, 0.6-5.5Vdc Output

General Specifications

PARAMETER	NOTES	MIN	TYP	MAX	UNITS
Calculated MTBF	Io = 0.8 Io-max, Ta = 40°C Telecordia Issue 2 Method 1 Case 3		16,817,995		Hours
Weight			2.33(0.082)		g (oz.)

Feature Specifications

PARAMETER	NOTES	MIN	TYP	MAX	UNITS
ON/OFF Signal Interface	Vin = min to max, open collector or equivalent, Signal reference to GND				
Positive Logic					
Logic High (Module ON)					
Input High Current				1	mA
Input High Voltage		3.0		Vin-max	Vdc
Logic Low (Module OFF)					
Input Low Current				10	uA
Input Low Voltage		-0.2		0.3	Vdc
Negative Logic	On/Off pin is open collector/drain logic input with external pull-up resistor; signal reference to GND				
Logic High (Module OFF)					
Input High Current				1	mA
Input High Voltage		3.0		Vin-max	Vdc
Logic Low (Module ON)					
Input Low Current				10	uA
Input Low Voltage		-0.2		0.4	Vdc

FGSR12SR6012*A

Data Sheet

3-14.4Vdc Input, 12A, 0.6-5.5Vdc Output

Feature Specifications (Continued)

PARAMETER	NOTES	MIN	TYP	MAX	UNITS
Turn-On Delay Time	Full resistive load				
with Vin (module enabled, then Vin applied)	From Vin=Vin(min) to 0.1*Vout(nom)		5		ms
with Enable (Vin applied, then enabled)	From enable to 0.1*Vout(nom)		5		ms
Rise Time (Full resistive load)	From 0.1*Vout(nom) to 0.9*Vout(nom)		2		ms
Output Voltage Overshoot	Ta = 25C, Vin = min to max, Iout = min to max, with or without external capacitance			3.0	%Vout
Over Temperature Protection (See Thermal Considerations section)			120/ 130		°C
Input Under Voltage Lockout					
Turn-on Threshold				2.9	Vdc
Turn-off Threshold		2.6			Vdc
Hysteresis			0.3		Vdc
Power Good					
Overvoltage threshold for PGOOD			112.5		%Vout
Undervoltage threshold for PGOOD			87.5		%Vout
Pulldown resistance of PGOOD pin			30		Ω
Sink current capability into PGOOD pin				5	mA

FGSR12SR6012*A

Data Sheet

3-14.4Vdc Input, 12A, 0.6-5.5Vdc Output

Design Considerations

Input Filtering

The **FGSR12SR6012*A** converter should be connected to a low ac-impedance source. A highly inductive source can affect the stability of the module. An input capacitance must be placed directly adjacent to the input pin of the module, to minimize input ripple voltage and ensure module stability.

To minimize input voltage ripple, ceramic capacitors are recommended at the input of the module. Fig-1 shows the input ripple voltage for various output voltages at 12A of load current with 2x22uF or 3x22uF ceramic capacitors and an input of 12V.

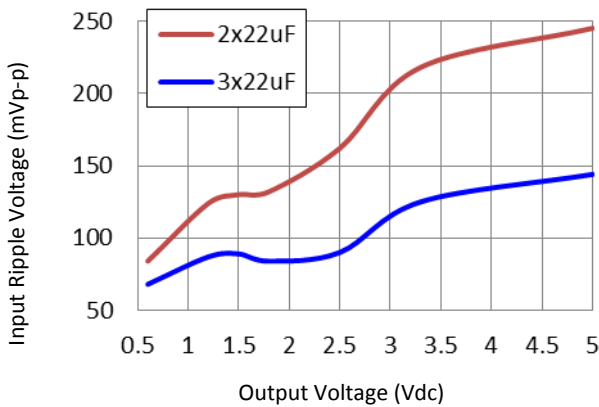

Fig-1: Input ripple voltage for various output voltages with 2x22uF or 3x22uF ceramic capacitors at the input (12A load). Input voltage is 12V.

Output Filtering

The **FGSR12SR6012*A** is designed for low output ripple voltage and will meet the maximum output ripple specification with 0.1uF ceramic and 2x47uF ceramic capacitors at the output of the module. However, additional output filtering may be required by the system designer for a number of reasons. First, there may be a need to further reduce the output ripple and noise of the module. Second, the dynamic response characteristics may need to be customized to a particular load step change.

To reduce the output ripple and improve the dynamic response to a step load change, additional capacitance at the output can be used. Low ESR polymer and ceramic capacitors are recommended to improve the dynamic response of the module. Fig-2 provides output ripple information for different external capacitance values at various Vo and a full

load current of 12A. For stable operation of the module, limit the capacitance to less than the maximum output capacitance as specified in the electrical specification table. Optimal performance of the module can be achieved by using the Tunable Loop™ feature described later in this data sheet.

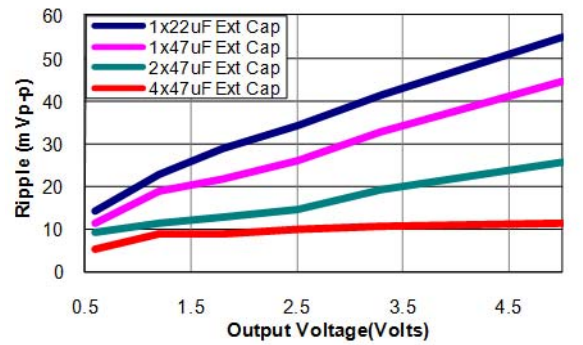

Fig-2: Output ripple voltage for various output voltages with external 1x22uF, 1x47uF, 2x47uF or 4x47uF ceramic capacitors at the output (12A load). Input voltage is 12V.

Safety Consideration

For safety agency approval the power module must be installed in compliance with the spacing and separation requirements of the end-use safety agency standards, i.e., UL 60950-1 2nd, CSA C22.2 No. 60950-1-07, DIN EN 60950-1:2006 + A11 (VDE0805 Teil 1 + A11):2009-11; EN 60950-1:2006 + A11:2009-03.

For the converter output to be considered meeting the requirements of safety extra-low voltage (SELV), the input must meet SELV requirements. The power module has extra-low voltage (ELV) outputs when all inputs are ELV.

The input to these units is to be provided with a time delay fuse with a maximum rating of 15 A in the positive input lead.

FGSR12SR6012*A

3-14.4Vdc Input, 12A, 0.6-5.5Vdc Output

Data Sheet

Feature Descriptions

Remote On/Off

The **FGSR12SR6012*A** power modules feature an On/Off pin for remote On/Off operation. Two On/Off logic options are available. In the Positive Logic On/Off option, (device code suffix "P" - see Ordering Information), the module turns ON during a logic High on the On/Off pin and turns OFF during a logic Low. With the Negative Logic On/Off option, (device code suffix "N" - see Ordering Information), the module turns OFF during logic High and ON during logic Low. The On/Off signal should be always referenced to ground. For either On/Off logic option, leaving the On/Off pin disconnected will turn the module ON when input voltage is present.

For positive logic modules, the circuit configuration for using the On/Off pin is shown in Fig-3. When the external transistor Q1 is in the OFF state, the internal PWM Enable signal is pulled high through an internal resistor and the external pullup resistor and the module is ON. When transistor Q1 is turned ON, the On/Off pin is pulled low and the module is OFF. A suggested value for R_{pullup} is TBD.

TBA

Fig-3: Circuit configuration for using positive On/Off logic.

For negative logic On/Off modules, the circuit configuration is shown in Fig-4. The On/Off pin should be pulled high with an external pull-up resistor (suggested value for the 3V to 14.4V input range is 20Kohms). When transistor Q1 is in the OFF state, the On/Off pin is pulled high, internal transistor Q4 is turned ON and the module is OFF. To turn the module ON, Q1 is turned ON pulling the On/Off pin low, turning transistor Q4 OFF resulting in the PWM Enable pin going high and the module turning ON.

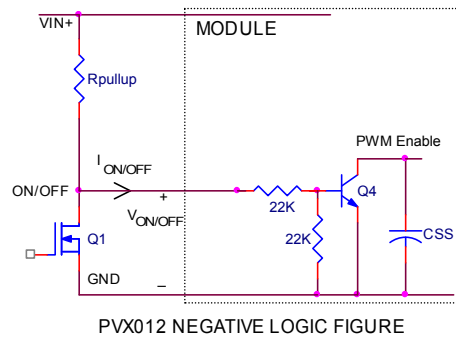

PVX012 NEGATIVE LOGIC FIGURE

Fig-4: Circuit configuration for using negative On/Off logic.

Monotonic Start-up and Shut-down

The module has monotonic start-up and shutdown behavior for any combination of rated input voltage, output current and operating temperature range.

Startup into Pre-biased Output

The module can start into a prebiased output as long as the prebias voltage is 0.5V less than the set output voltage.

FGSR12SR6012*A

Data Sheet

3-14.4Vdc Input, 12A, 0.6-5.5Vdc Output

Output Voltage Programming

The output voltage of the module is programmable to any voltage from 0.6Vdc to 5.5Vdc by connecting a resistor between the Trim and SIG_GND pins of the module. Certain restrictions apply on the output voltage set point depending on the input voltage. These are shown in the Output Voltage vs. Input Voltage Set Point Area plot in Fig-5. The Upper Limit curve shows that for output voltages lower than 1V, the input voltage must be lower than the maximum of 14.4V. The Lower Limit curve shows that for output voltages higher than 0.6V, the input voltage needs to be larger than the minimum of 3V.

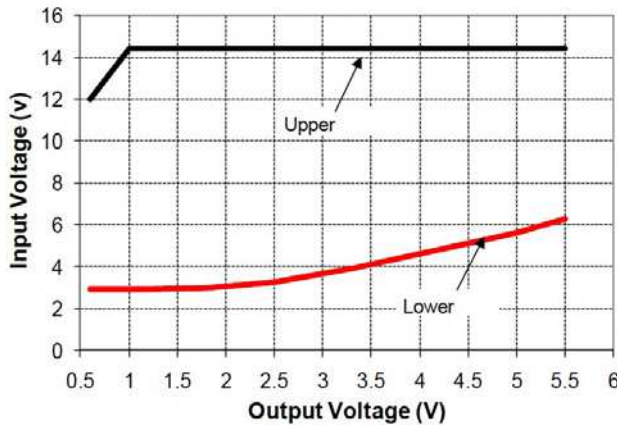

Fig-5: Output Voltage vs. Input Voltage Set Point Area plot showing limits where the output voltage can be set for different input voltages.

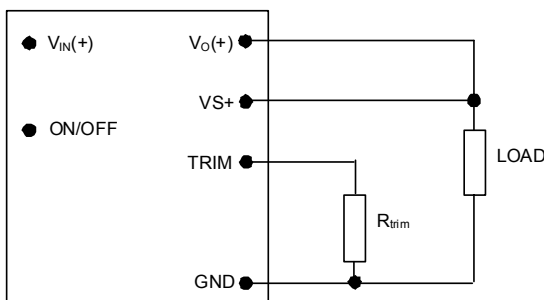

Fig-6: Output Voltage vs. Input Voltage Set Point Area plot showing limits where the output voltage can be set for different input voltages.

Without an external resistor between Trim and SIG_GND pins, the output of the module will be 0.6Vdc. To calculate the value of the trim resistor, R_{trim} for a desired output voltage, should be as per the following equation:

$$R_{TRIM} = \frac{12}{(V_{O-REQ} - 0.6)} [k\Omega]$$

R_{trim} is the external resistor in kohm
 V_{o-req} is the desired output voltage

Note that the tolerance of a trim resistor will affect the tolerance of the output voltage. Standard 1% or 0.5% resistors may suffice for most applications; however, a tighter tolerance can be obtained by using two resistors in series instead of one standard value resistor.

Table 1 lists calculated values of R_{TRIM} for common output voltages. For each value of R_{TRIM} , Table 1 also shows the closest available standard resistor value.

Table 1: Trim Resistor Value	
V_{O-REG} [V]	R_{TRIM} [kΩ]
0.6	Open
0.9	40
1.0	30
1.2	20
1.5	13.33
1.8	10
2.5	6.316
3.3	4.444
5.0	2.727

Remote Sense

The power module has a Remote Sense feature to minimize the effects of distribution losses by regulating the voltage at the SENSE pin. The voltage between the SENSE pin and VOUT pin should not exceed 0.5V.

Voltage Margining

Output voltage margining can be implemented in the module by connecting a resistor, $R_{margin-up}$, from the Trim pin to the ground pin for margining-up the output voltage and by connecting a resistor, $R_{margin-down}$, from the Trim pin to output pin for margining-down. Fig-7 shows the circuit configuration for output voltage margining.

The POL Programming Tool, available at www.fdk.com under the Downloads section, also calculates the values of $R_{margin-up}$ and $R_{margin-down}$ for a specific output voltage and % margin. Please consult your local FDK FAE for additional details.

FGSR12SR6012*A

Data Sheet

3-14.4Vdc Input, 12A, 0.6-5.5Vdc Output

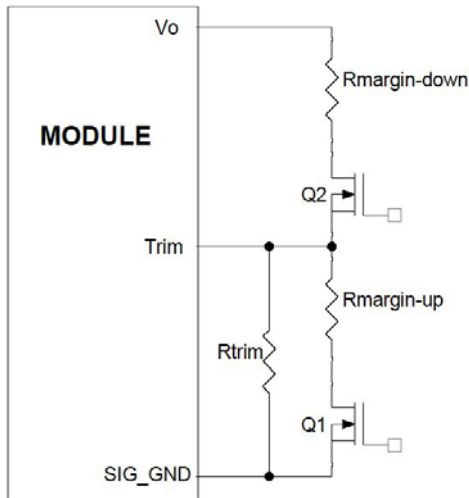

Fig-7: Circuit Configuration for margining Output Voltage.

Over-Current Protection

To provide protection in a fault (output overload) condition, the unit is equipped with internal current-limiting circuitry and can endure current limiting continuously. At the point of current-limit inception, the unit enters hiccup mode. The unit operates normally once the output current is brought back into its specified range.

Over-Temperature Protection

To provide protection in a fault condition, the unit is equipped with a thermal shutdown circuit. The unit will shutdown if the overtemperature threshold of 120(Q1) / 130(L1)^oC(typ) is exceeded at the thermal reference point T_{ref}. Once the unit goes into thermal shutdown it will then wait to cool before attempting to restart.

Input Under-Voltage Lockout (UVLO)

At input voltages below the input under-voltage lockout limit, the module operation is disabled. The module will begin to operate at an input voltage above the under-voltage lockout turn-on threshold.

Power Good

The module provides a Power Good (PGOOD) signal that is implemented with an open-drain output to indicate that the output voltage is within the regulation limits of the power module. The PGOOD

signal will be de-asserted to a low state if any condition such as over-temperature, over-current or loss of regulation occurs that would result in the output voltage going ±10% outside the setpoint value. The PGOOD terminal can be connected through a pull-up resistor (suggested value 100KΩ) to a source of 5VDC or lower.

Dual Layout

Identical dimensions and pin layout of Analog and Digital 12A **Tomodachi** modules permit migration from one to the other without needing to change the layout. To support this, 2 separate Trim Resistor locations have to be provided in the layout. For the digital modules, the resistor is connected between the TRIM pad and SGND and in the case of the analog module it is connected between TRIM and GND

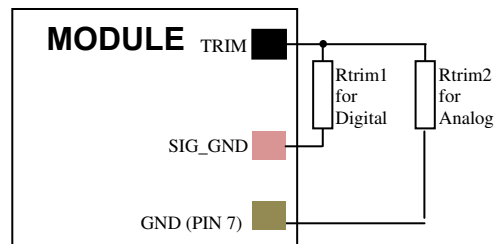

Caution – Do not connect SIG_GND to GND elsewhere in the layout

Fig-9: Layout to support either Analog or Digital 12A **Tomodachi** modules on the same pad.

Tunable Loop™

The module has a feature that optimizes transient response of the module called Tunable Loop™

External capacitors are usually added to the output of the module for two reasons: to reduce output ripple and noise (see Fig-10) and to reduce output voltage deviations from the steady-state value in the presence of dynamic load current changes. Adding external capacitance however affects the voltage control loop of the module, typically causing the loop to slow down with sluggish response. Larger values of external capacitance could also cause the module to become unstable.

The Tunable Loop™ allows the user to externally adjust the voltage control loop to match the filter network connected to the output of the module. The Tunable Loop™ is implemented by connecting a series R-C between the VS+ and TRIM pins of the module, as shown in Fig-10. This R-C allows the user

FGSR12SR6012*A

3-14.4Vdc Input, 12A, 0.6-5.5Vdc Output

Data Sheet

to externally adjust the voltage loop feedback compensation of the module.

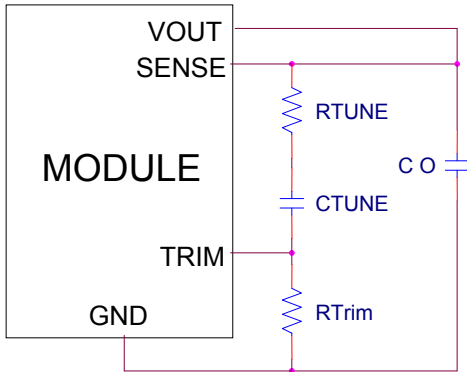

Fig-10: Circuit diagram showing connection of R_{TUNE} and C_{TUNE} to tune the control loop of the module.

Recommended values of R_{TUNE} and C_{TUNE} for different output capacitor combinations are given in Tables 2. Table 2 shows the recommended values of R_{TUNE} and C_{TUNE} for different values of ceramic output capacitors up to 1000uF that might be needed for an application to meet output ripple and noise requirements. Selecting R_{TUNE} and C_{TUNE} according to Table 2 will ensure stable operation of the module. In applications with tight output voltage limits in the presence of dynamic current loading, additional output capacitance will be required. Table 3 lists recommended values of R_{TUNE} and C_{TUNE} in order to meet 2% output voltage deviation limits for some common output voltages in the presence of a 6A to 12A step change (50% of full load), with an input voltage of 12V.

Please contact your FDK technical representative to obtain more details of this feature as well as for guidelines on how to select the right value of external R-C to tune the module for best transient performance and stable operation for other output capacitance values.

Table 2: General recommended value of R_{TUNE} and C_{TUNE} for $V_{in}=12V$ and various external ceramic capacitor combinations.					
C_o	1x47uF	2x47uF	4x47uF	6x47uF	10x47uF
R_{TUNE}	330	330	330	330	270
C_{TUNE}	100pF	560pF	1500pF	2200pF	3900pF

Table 3: Recommended values of R_{TUNE} and C_{TUNE} to obtain transient deviation of 2% of V_{out} for a 6A step load with $V_{in}=12V$.

V_o	5V	3.3V	2.5V	1.8V	1.2V	0.6V
C_o	5x47uF	1x47uF + 1x330uF Polymer	3x47uF + 1x330uF Polymer	1x47uF + 2x330uF Polymer	1x47uF + 3x330uF Polymer	3x47uF + 6x330uF Polymer
R_{TUNE}	330	330	270	270	220	180
C_{TUNE}	1500pF	2700pF	3300pF	5600pF	10nF	47nF
ΔV	99mV	58mV	47mV	34mV	24mV	12mV

Note: The capacitors used in the Tunable Loop tables are 47uF/3 mΩ ESR ceramic and 330uF/12 mΩ ESR polymer capacitors.

FGSR12SR6012*A

Data Sheet

3-14.4Vdc Input, 12A, 0.6-5.5Vdc Output

Characterization

Overview

The converter has been characterized for several operational features, including efficiency, thermal derating (maximum available load current as a function of ambient temperature and airflow), ripple and noise, transient response to load step changes, start-up and shutdown characteristics.

Figures showing data plots and waveforms for different output voltages are presented in the following pages.

Thermal Considerations

Power modules operate in a variety of thermal environments; however, sufficient cooling should always be provided to help ensure reliable operation.

Considerations include ambient temperature, airflow, module power dissipation, and the need for increased reliability. A reduction in the operating temperature of the module will result in an increase in reliability. The thermal data presented here is based on physical measurements taken in a wind tunnel. The test set-up is shown in Fig-11. The preferred airflow direction for the module is in Fig-12.

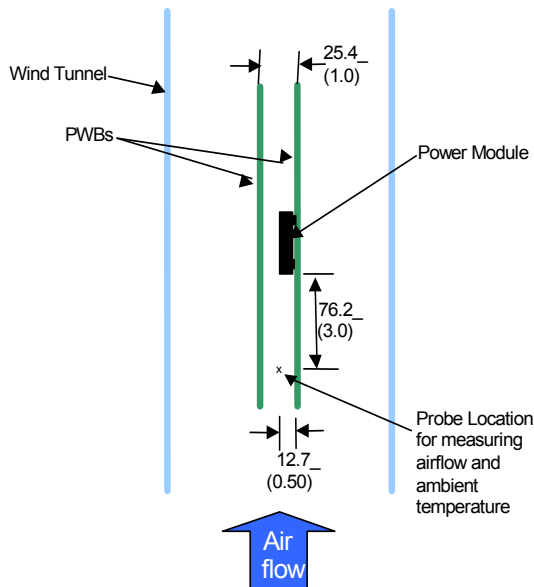

Fig-11: Thermal test set-up

The thermal reference points, T_{ref} used in the specifications are also shown in Fig-12. For reliable operation the temperature at Q1 should not exceed 120°C and the temperature at L1 should not exceed 130°C. The output power of the module should not

exceed the rated power of the module ($V_{o,set} \times I_{o,max}$).

Note that continuous operation beyond the derated current as specified by the derating curves may lead to degradation in performance and reliability of the converter and may result in permanent damage.

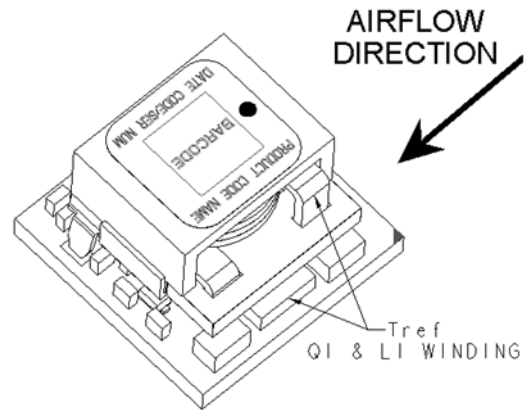

Fig-12: Preferred airflow direction and location of hot-spot of the module (T_{ref}).

The main heat dissipation method of this converter is to transfer its heat to the system board. Thus, if the temperature of the system board goes high, even with the low ambient temperature, it may exceed the guaranteed temperature of components.

FGSR12SR6012*A

Data Sheet

3-14.4Vdc Input, 12A, 0.6-5.5Vdc Output

Characteristic Curves

The following figures provide typical characteristics for the 12A Analog **Tomodachi** at 5V_o and 25°C

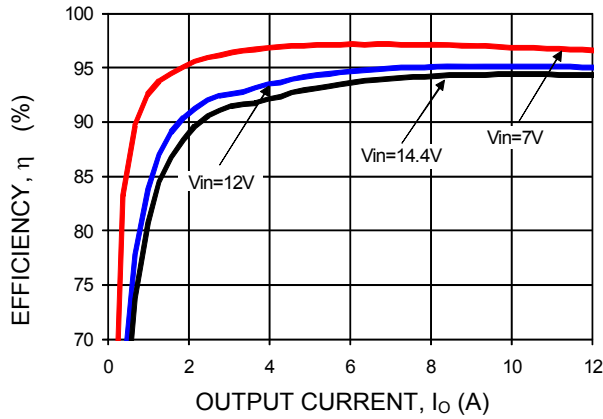

Fig-13. Converter Efficiency versus Output Current.

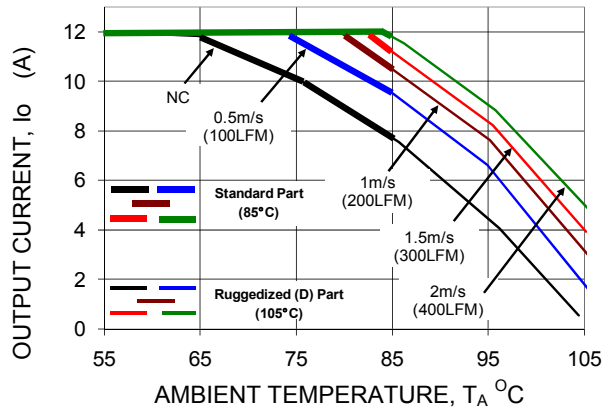

Fig-14. Derating Output Current versus Ambient Temperature and Airflow.

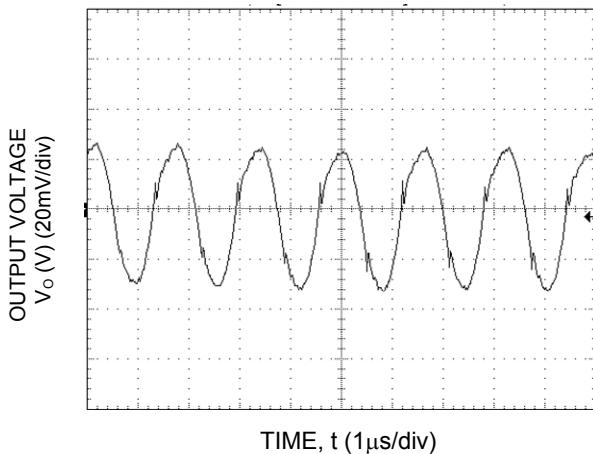

Fig-15. Typical output ripple and noise (C_o=22μF ceramic, VIN = 12V, I_o = I_{o,max}).

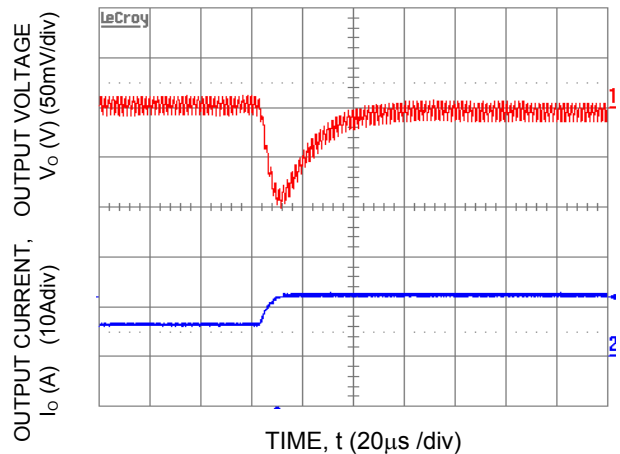

Fig-16. Transient Response to Dynamic Load Change from 50% to 100% at 12Vin, Cout-5x47uF, CTune-1500pF & RTune-330ohms

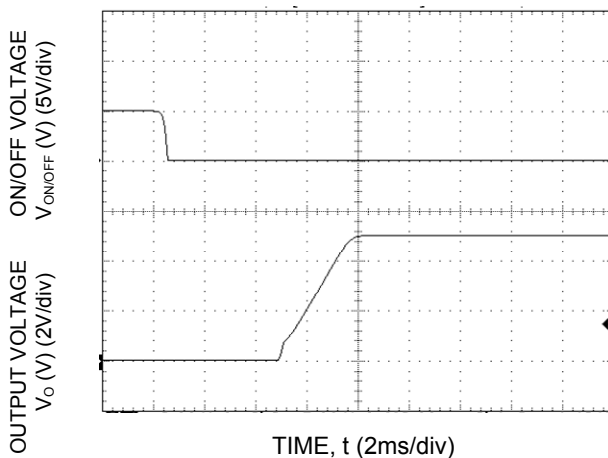

Fig-17. Typical Start-up Using On/Off Voltage (I_o = I_{o,max}).

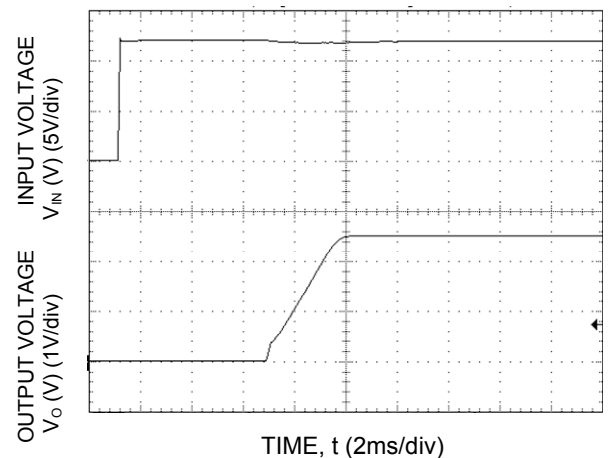

Fig-18. Typical Start-up Using Input Voltage (VIN = 12V, I_o = I_{o,max}).

FGSR12SR6012*A

3-14.4Vdc Input, 12A, 0.6-5.5Vdc Output

Data Sheet

Characteristic Curves

The following figures provide typical characteristics for the 12A Analog **Tomodachi** at 3.3V_o and 25°C

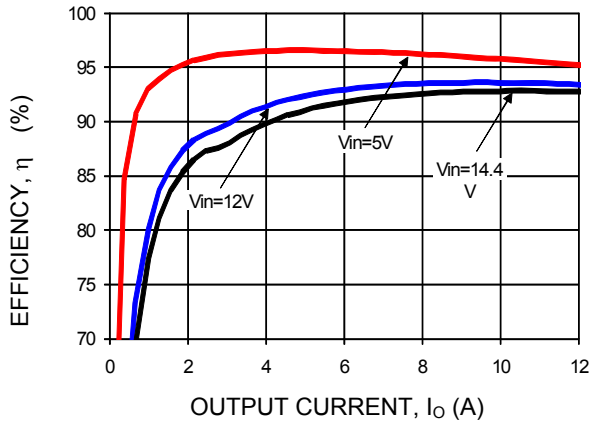

Fig-19. Converter Efficiency versus Output Current.

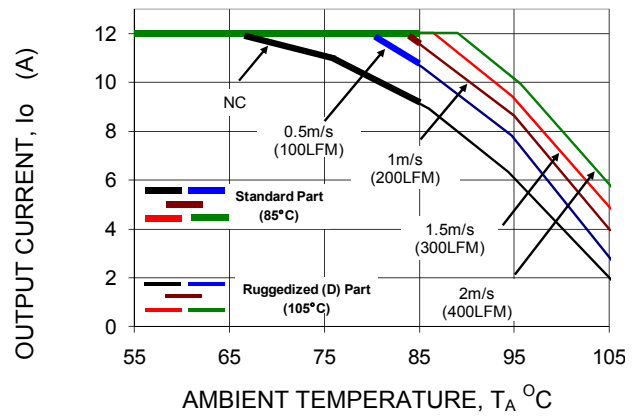

Fig-20. Derating Output Current versus Ambient Temperature and Airflow.

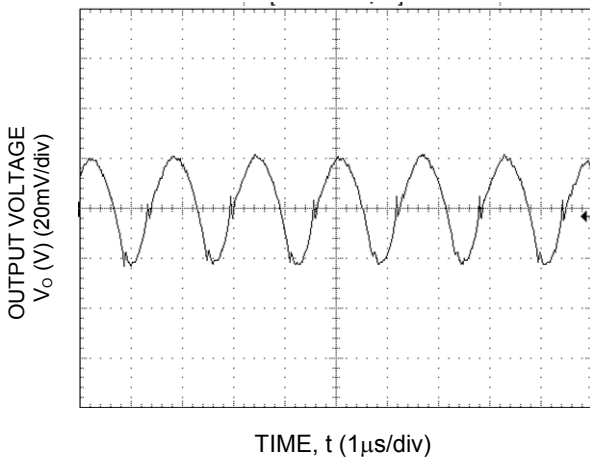

Fig-21. Typical output ripple and noise ($C_o=22\mu F$ ceramic, $V_{IN} = 12V$, $I_o = I_{o,max}$).

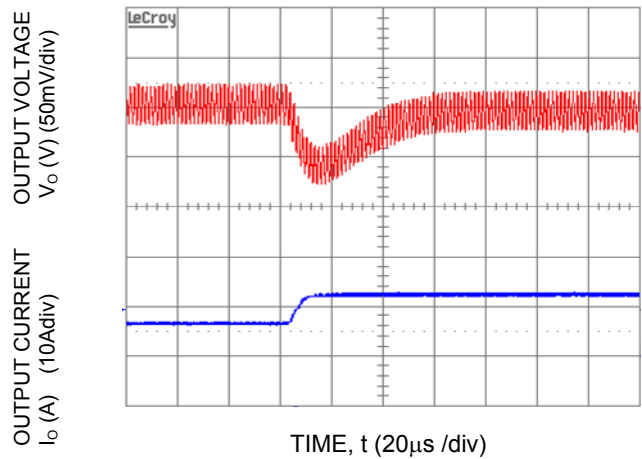

Fig-22. Transient Response to Dynamic Load Change from 50% to 100% at 12Vin, Cout-1x47 μ F+1x330 μ F, CTune-2700pF & RTune-330ohms

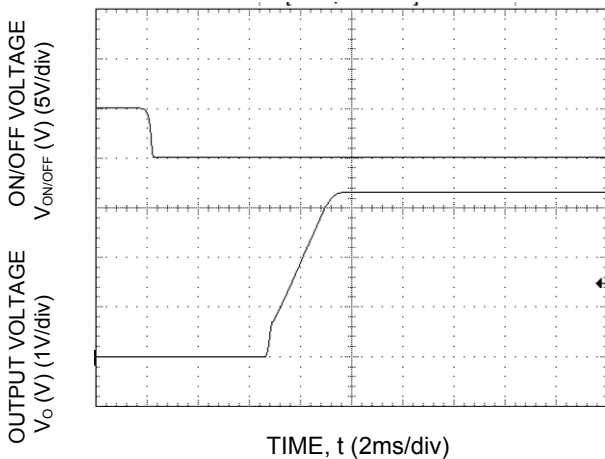

Fig-23. Typical Start-up Using On/Off Voltage ($I_o = I_{o,max}$).

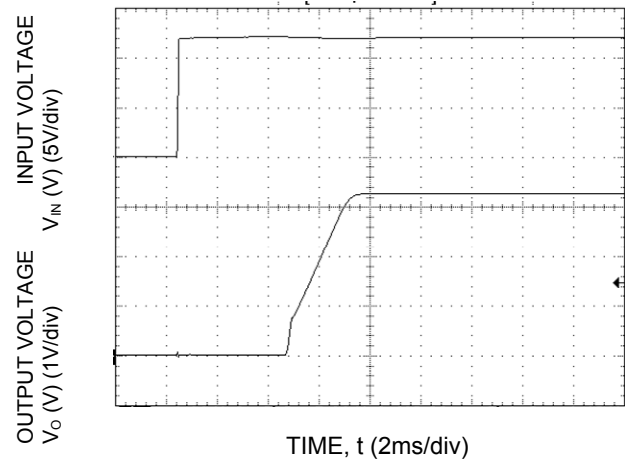

Fig-24. Typical Start-up Using Input Voltage ($V_{IN} = 12V$, $I_o = I_{o,max}$).

FGSR12SR6012*A

3-14.4Vdc Input, 12A, 0.6-5.5Vdc Output

Data Sheet

Characteristic Curves

The following figures provide typical characteristics for the 12A Analog **Tomodachi** at 2.5Vo and 25°C

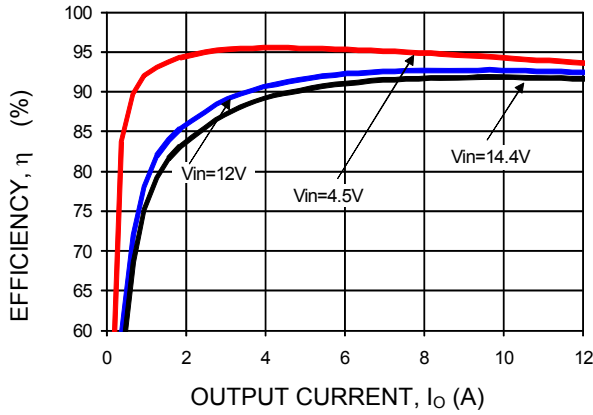

Fig-25. Converter Efficiency versus Output Current.

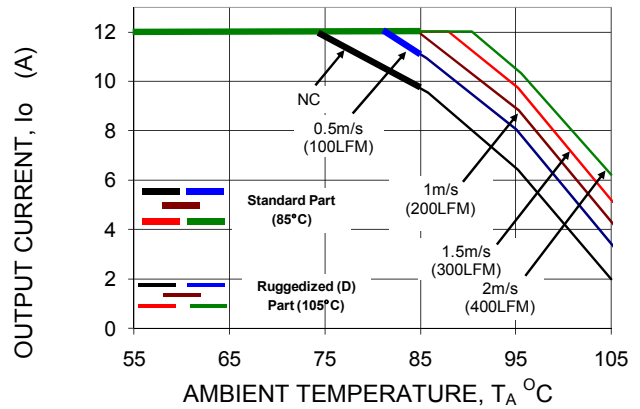

Fig-26. Derating Output Current versus Ambient Temperature and Airflow.

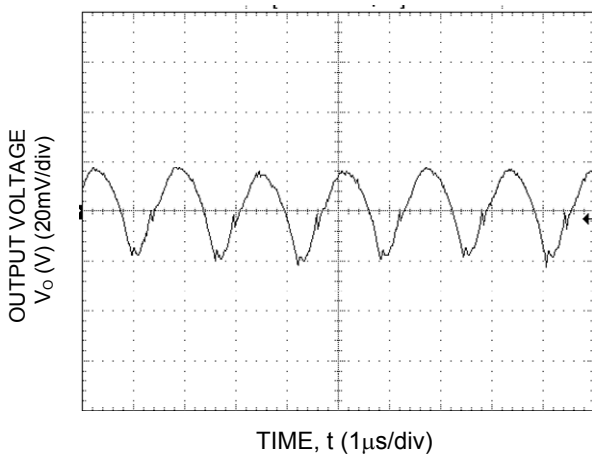

Fig-27. Typical output ripple and noise (Co=22µF ceramic, VIN = 12V, Io = Io,max,).

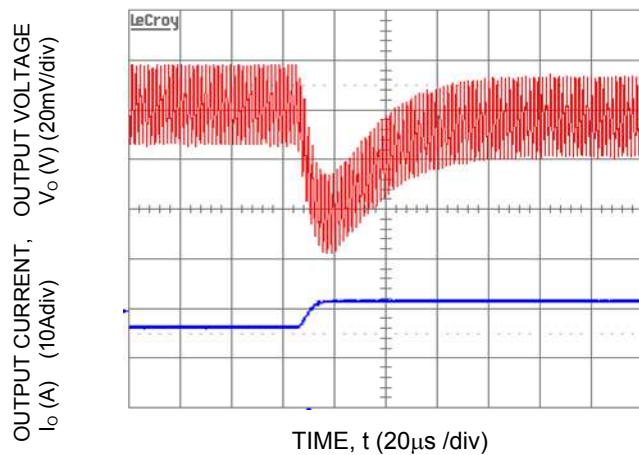

Fig-28. Transient Response to Dynamic Load Change from 50% to 100% at 12Vin, Cout-1x47uF+1x330uF, CTune-3300pF & RTune-270ohms

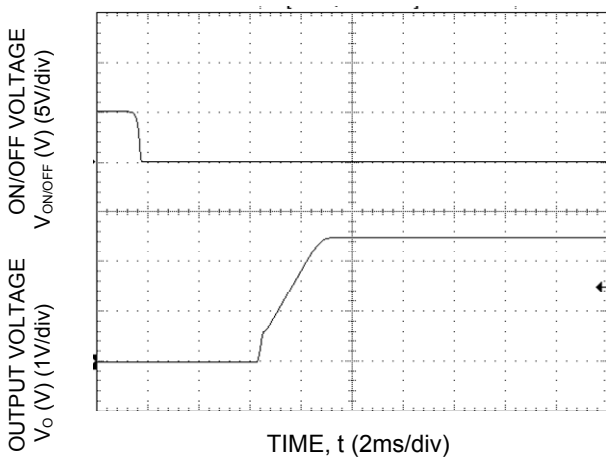

Fig-29. Typical Start-up Using On/Off Voltage (Io = Io,max).

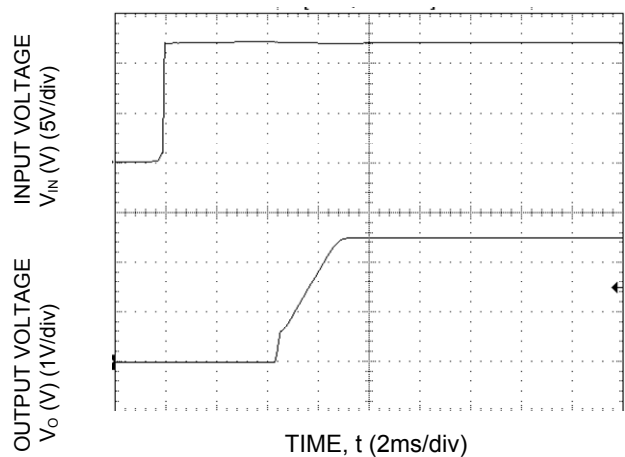

Fig-30. Typical Start-up Using Input Voltage (VIN = 12V, Io = Io,max).

FGSR12SR6012*A

3-14.4Vdc Input, 12A, 0.6-5.5Vdc Output

Data Sheet

Characteristic Curves

The following figures provide typical characteristics for the 12A Analog **Tomodachi** at 1.8V_o and 25°C

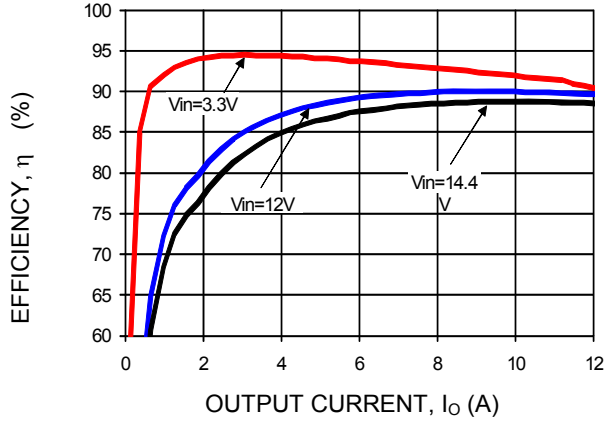

Fig-31. Converter Efficiency versus Output Current.

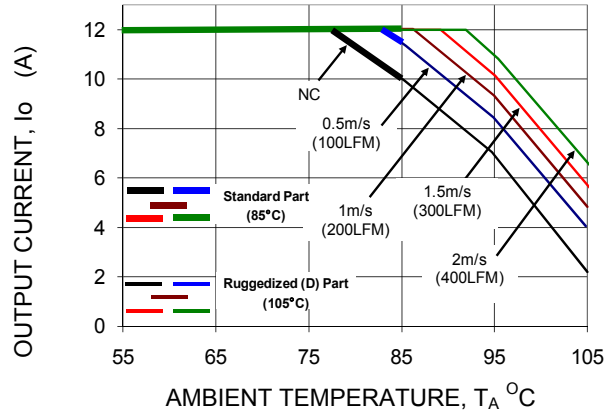

Fig-32. Derating Output Current versus Ambient Temperature and Airflow.

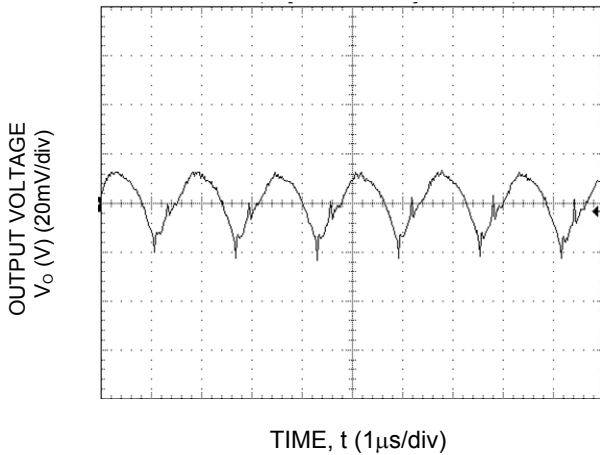

Fig-33. Typical output ripple and noise (C_o=22µF ceramic, V_{IN} = 12V, I_o = I_{o,max}.)

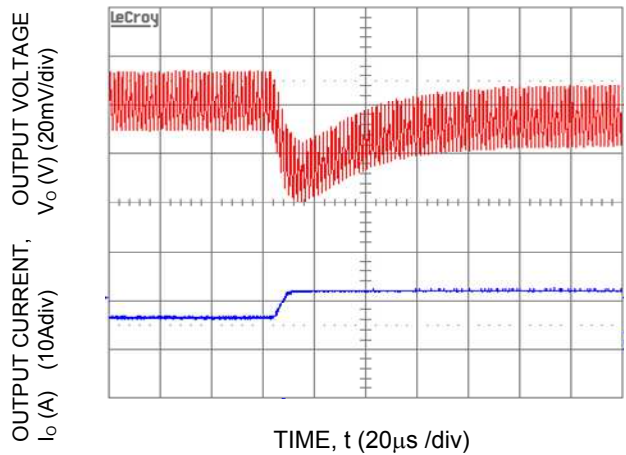

Fig-34. Transient Response to Dynamic Load Change from 50% to 100% at 12V_{in}, C_{out}=1x47µF+2x330µF, C_Ttune=5600pF & R_Ttune=270ohms

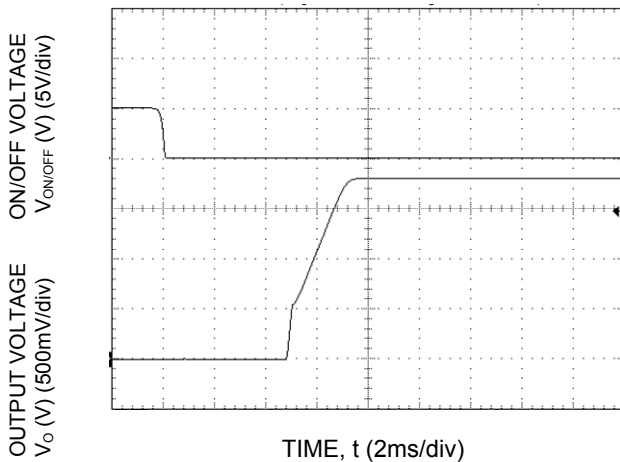

Fig-35. Typical Start-up Using On/Off Voltage (I_o = I_{o,max}).

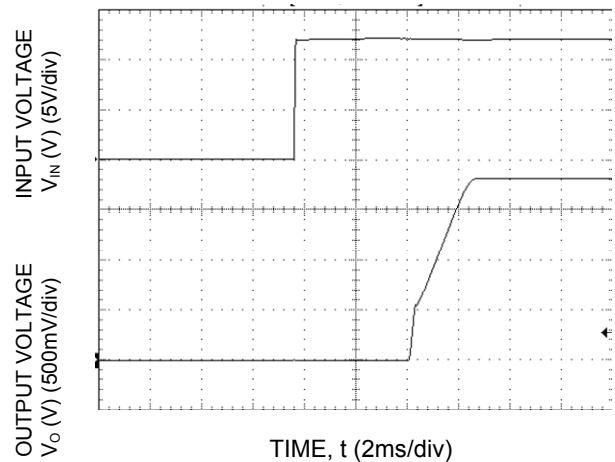

Fig-36. Typical Start-up Using Input Voltage (V_{IN} = 12V, I_o = I_{o,max}).

FGSR12SR6012*A

3-14.4Vdc Input, 12A, 0.6-5.5Vdc Output

Data Sheet

Characteristic Curves

The following figures provide typical characteristics for the 12A Analog **Tomodachi** at 1.2Vo and 25°C

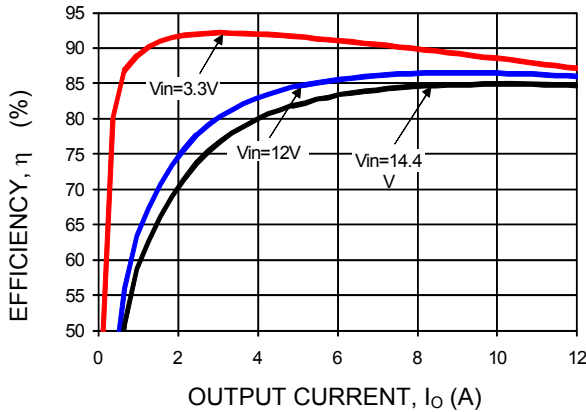

Fig-37. Converter Efficiency versus Output Current.

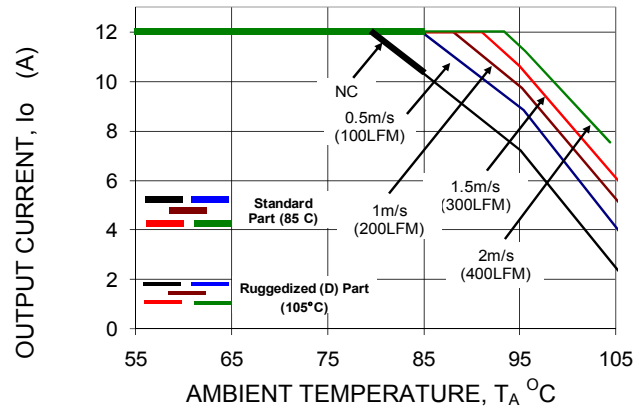

Fig-38. Derating Output Current versus Ambient Temperature and Airflow.

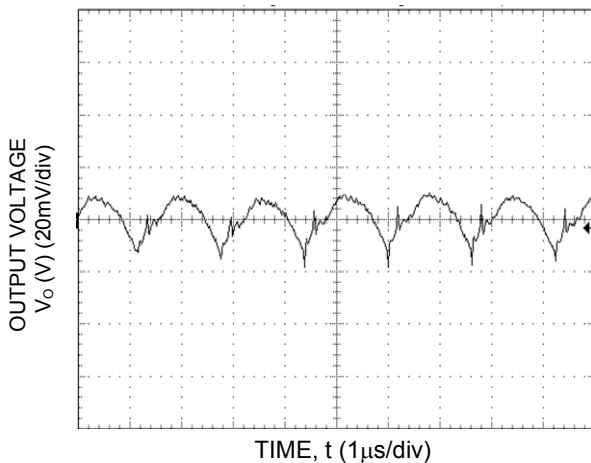

Fig-39. Typical output ripple and noise ($C_O=22\mu F$ ceramic, $V_{IN} = 12V$, $I_o = I_{o,max}$).

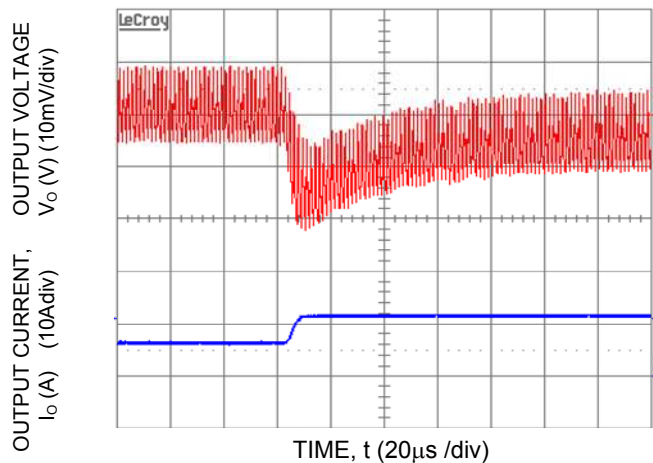

Fig-40. Transient Response to Dynamic Load Change from 50% to 100% at 12Vin, $C_{out}=1x47\mu F+3x330\mu F$, $C_{Tune}=10nF$ & $R_{Tune}=220ohms$

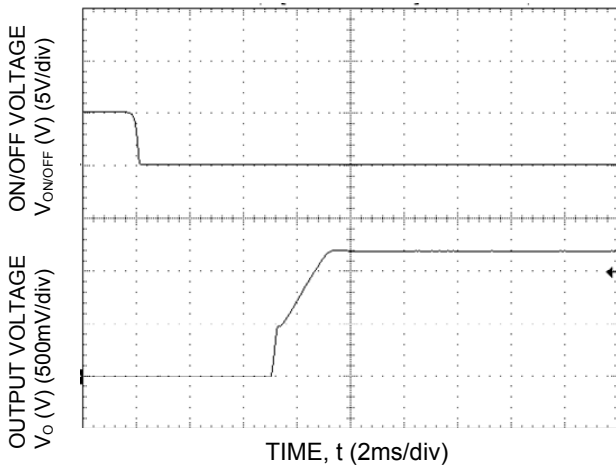

Fig-41. Typical Start-up Using On/Off Voltage ($I_o = I_{o,max}$).

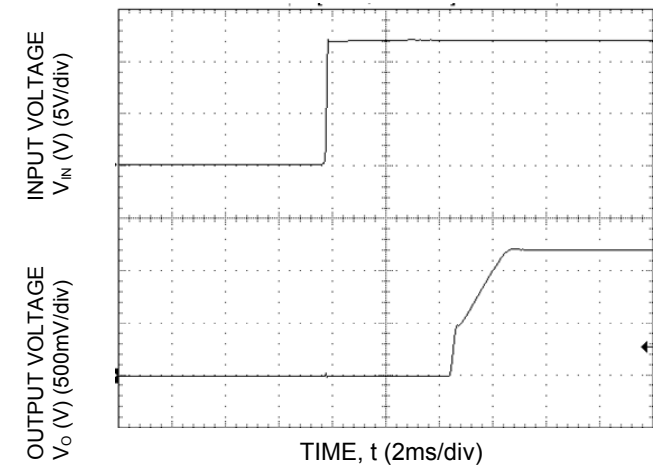

Fig-42. Typical Start-up Using Input Voltage ($V_{IN} = 12V$, $I_o = I_{o,max}$).

FGSR12SR6012*A

3-14.4Vdc Input, 12A, 0.6-5.5Vdc Output

Data Sheet

Characteristic Curves

The following figures provide typical characteristics for the 12A Analog **Tomodachi** at 0.6V_o and 25°C

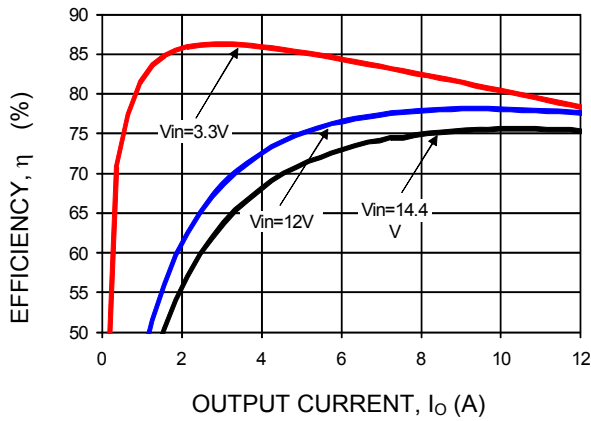

Fig-43. Converter Efficiency versus Output Current.

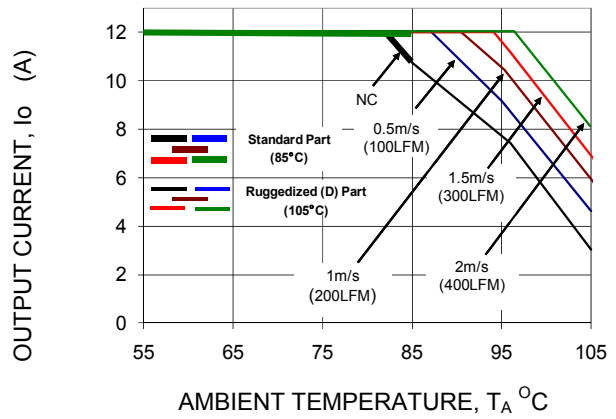

Fig-442. Derating Output Current versus Ambient Temperature and Airflow.

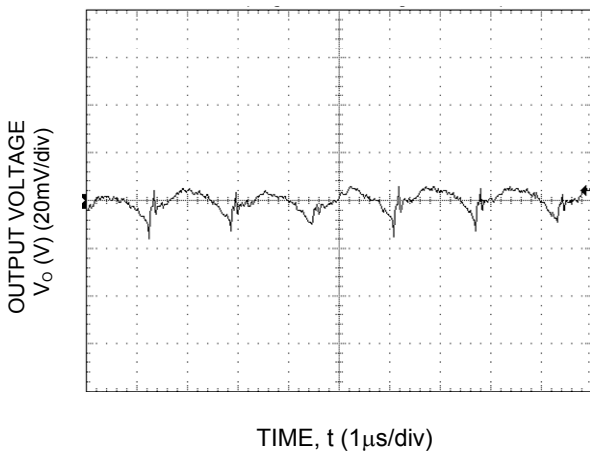

Fig-45. Typical output ripple and noise (C_o=22µF ceramic, V_{IN} = 12V, I_o = I_{o,max}).

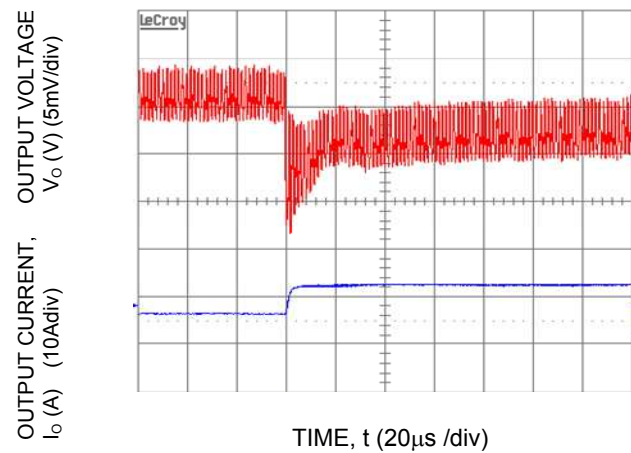

Fig-46. Transient Response to Dynamic Load Change from 50% to 100% at 12Vin, C_{out}-3x47µF+6x330µF, CT_{tune}-47nF, RT_{tune}-180ohms

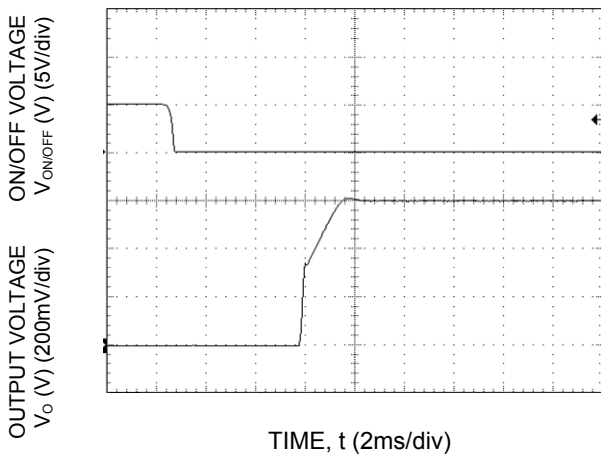

Fig-47. Typical Start-up Using On/Off Voltage (I_o = I_{o,max}).

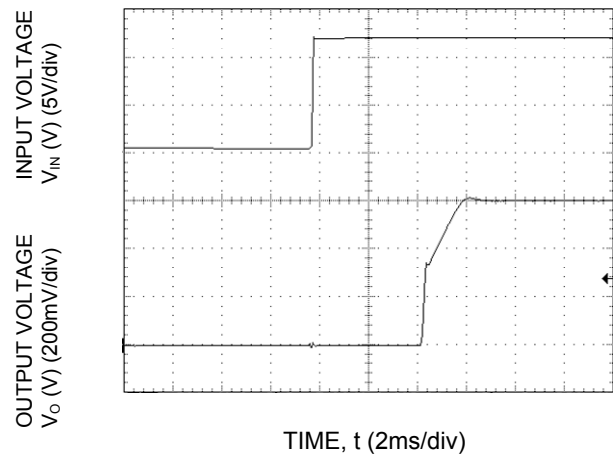

Fig-48. Typical Start-up Using Input Voltage (V_{IN} = 12V, I_o = I_{o,max}).

FGSR12SR6012*A

Data Sheet

3-14.4Vdc Input, 12A, 0.6-5.5Vdc Output

Example Application Circuit

Requirements:

Vin: 12V
 Vout: 1.8V
 Iout: 9A max., worst case load transient is from 6A to 9A
 ΔV_{out} : 1.5% of Vout (27mV) for worst case load transient
 Vin, ripple: 1.5% of Vin (180mV, p-p)

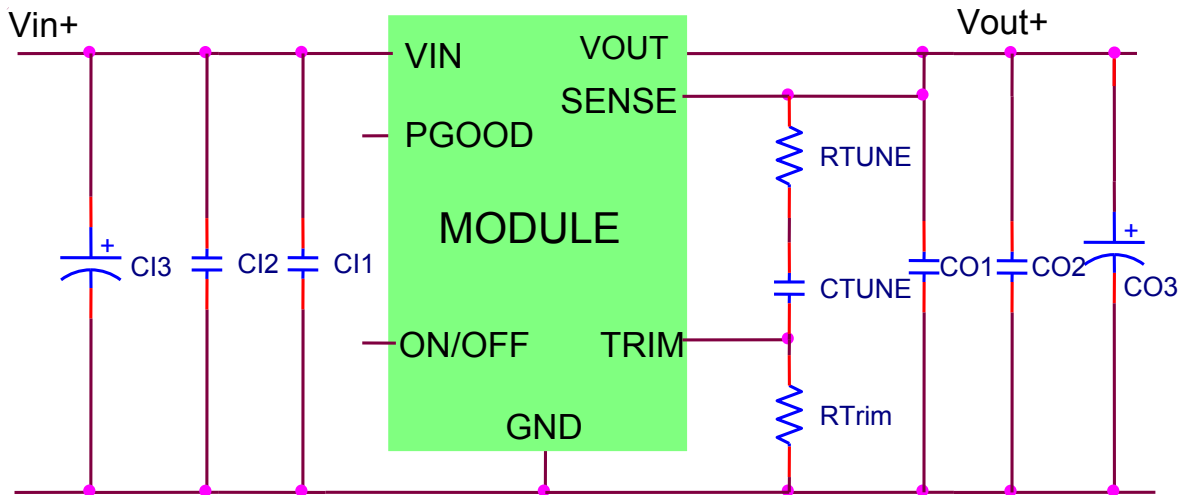

- C11 Decoupling cap – 1 x 0.01uF/16V ceramic capacitor (e.g. Murata LLL185R71E103MA01)
- C12 2 x 22uF/16V ceramic capacitor (e.g. Murata GRM32ER61C226KE20)
- C13 470uF/16V bulk electrolytic
- CO1 Decoupling cap – 1 x 0.01uF/16V ceramic capacitor (e.g. Murata LLL185R71E103MA01)
- CO2 2 x 47uF/6.3V ceramic capacitor (e.g. Murata GRM31CR60J476ME19)
- CO3 1 x 330uF/6.3V Polymer (e.g. Sanyo Poscap)
- CTune 3300pF ceramic capacitor (can be 1206, 0805 or 0603 size)
- RTune 270 ohms SMT resistor (can be 1206, 0805 or 0603 size)
- RTrim 10kΩ SMT resistor (can be 1206, 0805 or 0603 size, recommended tolerance of 0.1%)

FGSR12SR6012*A

3-14.4Vdc Input, 12A, 0.6-5.5Vdc Output

Data Sheet

Mechanical Drawing

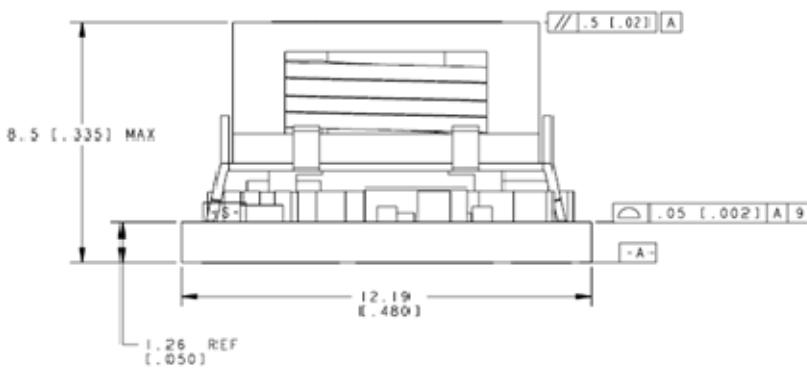
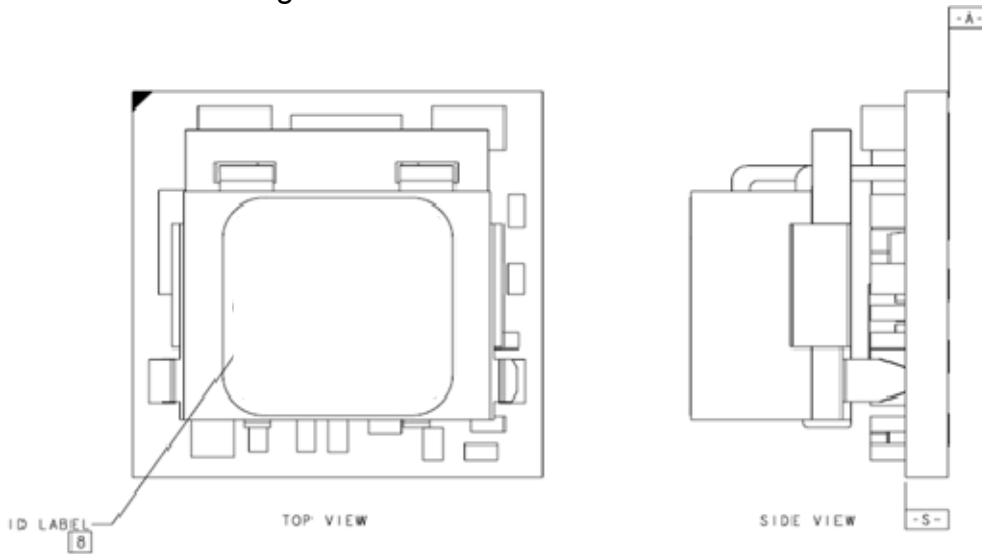

Notes

- All dimensions are in millimeters (inches)
- Tolerances:
 x.x mm \pm 0.5 mm (x.xx in. \pm 0.02 in.)
 [unless otherwise indicated]
 x.xx mm \pm 0.25 mm (x.xxx in \pm 0.010 in.)

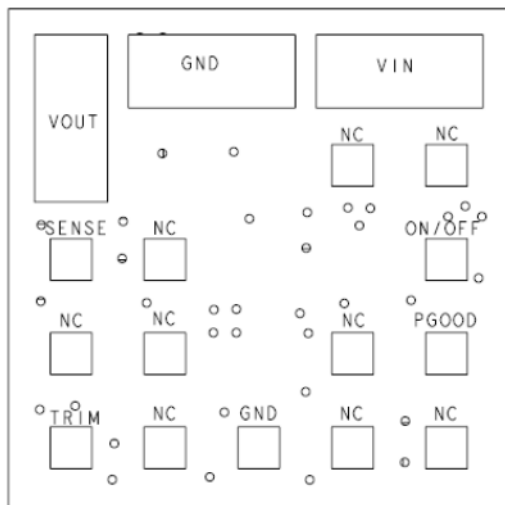

BOTTOM VIEW

Pin Connections			
Pin #	Function	Pin #	Function
1	ON/OFF	10	PGOOD
2	Vin	11	NC
3	GND	12	NC
4	Vout	13	NC
5	VS+	14	NC
6	TRIM	15	NC
7	GND	16	NC
8	NC	17	NC
9	NC		

FGSR12SR6012*A

Data Sheet

3-14.4Vdc Input, 12A, 0.6-5.5Vdc Output

Recommended Pad Layout

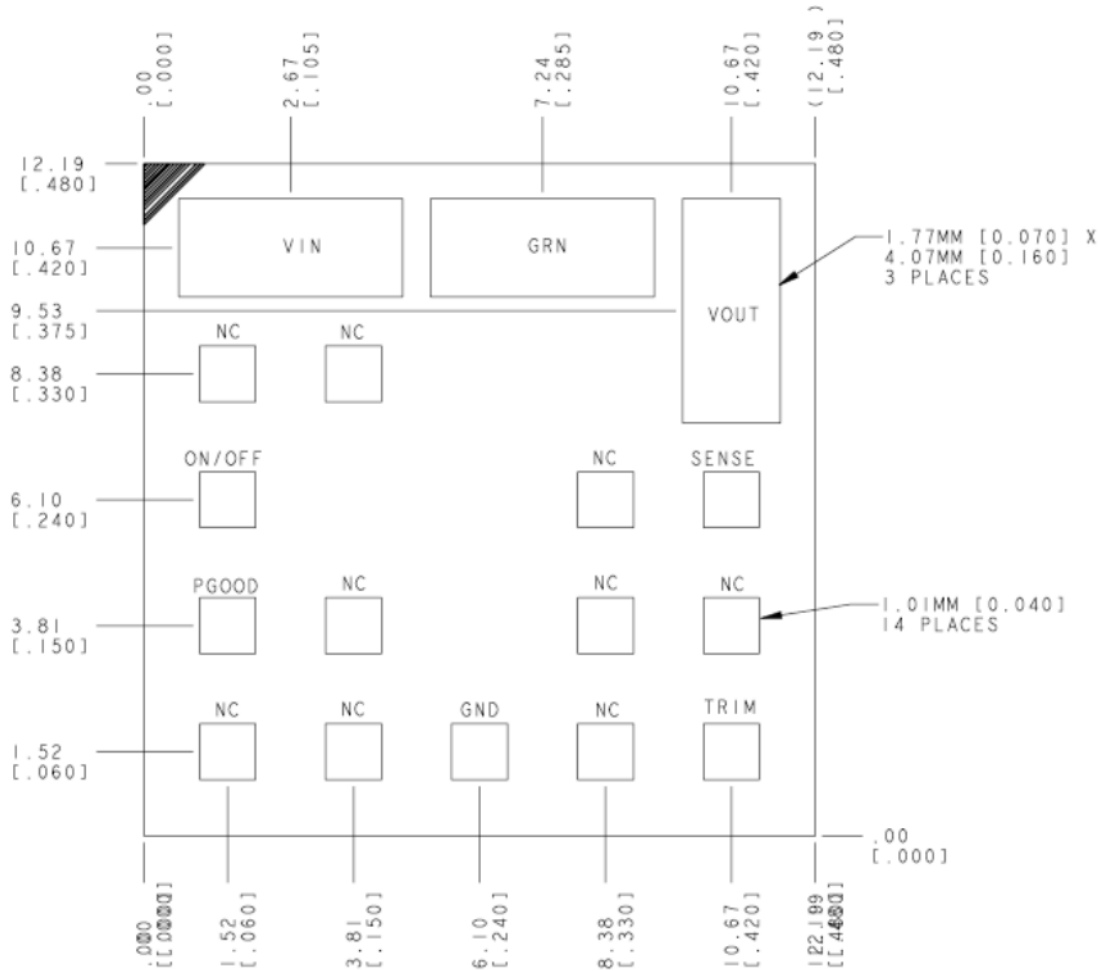

RECOMMENDED FOOTPRINT
- THROUGH THE BOARD -

Pin Connections			
Pin #	Function	Pin #	Function
1	ON/OFF	10	PGOOD
2	Vin	11	NC
3	GND	12	NC
4	Vout	13	NC
5	VS+	14	NC
6	TRIM	15	NC
7	GND	16	NC
8	NC	17	NC
9	NC		

Notes

- All dimensions are in millimeters (inches)
- Tolerances:
 x.x mm ± 0.5 mm (x.xx in. ± 0.02 in.)
 [unless otherwise indicated]
 x.xx mm ± 0.25 mm (x.xxx in. ± 0.010 in.)

FGSR12SR6012*A

Data Sheet

3-14.4Vdc Input, 12A, 0.6-5.5Vdc Output

Packaging Details

The 12A Analog **Tomodachi** modules are supplied in tape & reel as standard. Modules are shipped in quantities of 200 modules per reel.

All Dimensions are in millimeters and (in inches).

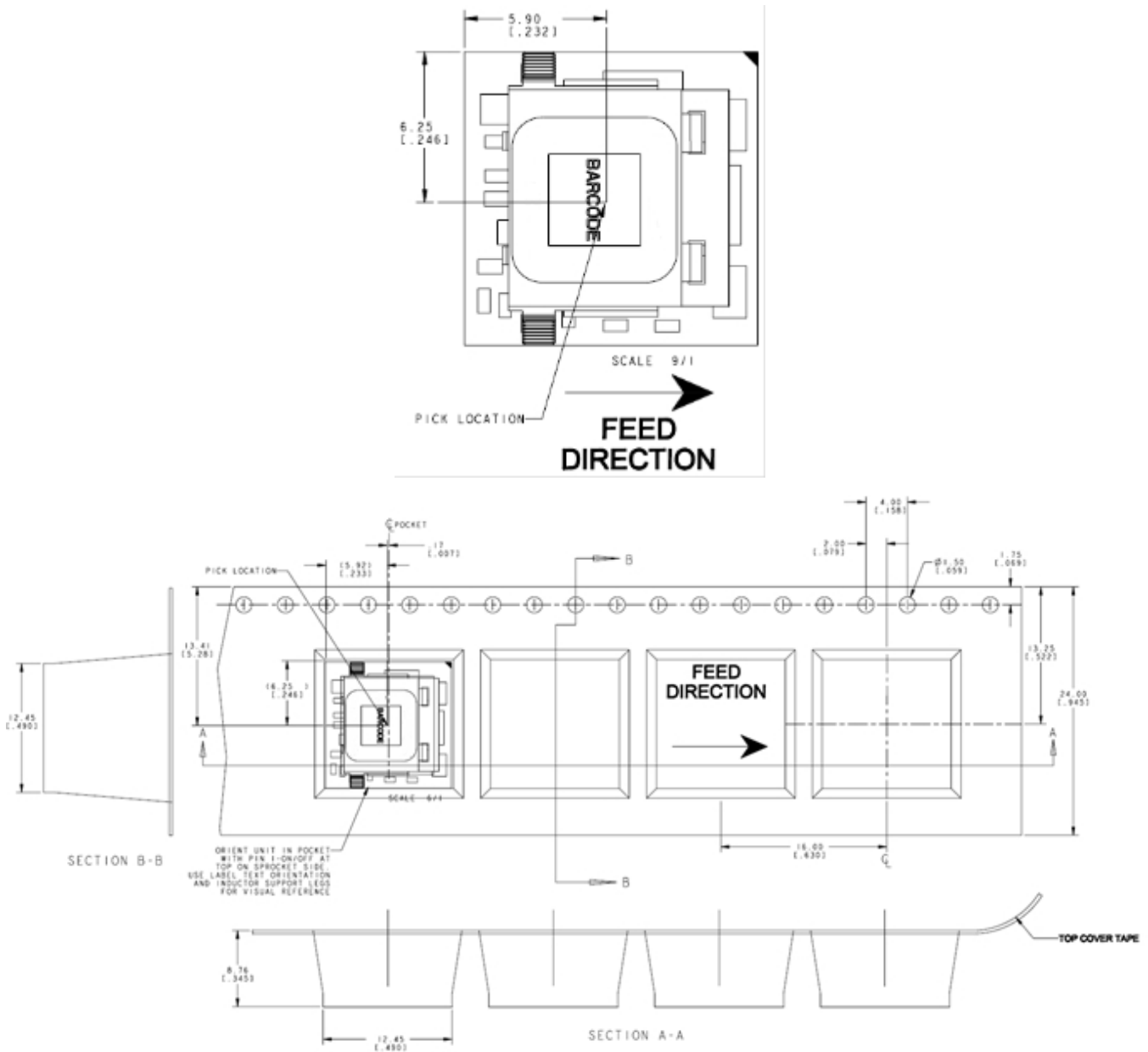

- Reel Dimensions:
- Outside Dimensions: 330.2 mm (13.00")
- Inside Dimensions: 177.8 mm (7.00")
- Tape Width: 24.00 mm (0.945")

FGSR12SR6012*A

Data Sheet

3-14.4Vdc Input, 12A, 0.6-5.5Vdc Output

Surface Mount Information

Pick and Place

The 12A Analog **Tomodachi** modules use an open frame construction and are designed for a fully automated assembly process. The modules are fitted with a label designed to provide a large surface area for pick and place operations. The label meets all the requirements for surface mount processing, as well as safety standards, and is able to withstand reflow temperatures of up to 300°C. The label also carries product information such as product code, serial number and the location of manufacture.

Nozzle Recommendations

The module weight has been kept to a minimum by using open frame construction. Variables such as nozzle size, tip style, vacuum pressure and placement speed should be considered to optimize this process. The minimum recommended inside nozzle diameter for reliable operation is 3mm. The maximum nozzle outer diameter, which will safely fit within the allowable component spacing, is 7mm.

Bottom Side / First Side Assembly

This module is not recommended for assembly on the bottom side of a customer board. If such an assembly is attempted, components may fall off the module during the second reflow process.

Lead Free Soldering

The modules are lead-free (Pb-free) and RoHS compliant and fully compatible in a Pb-free soldering process. Failure to observe the instructions below may result in the failure of or cause damage to the modules and can adversely affect long-term reliability.

Pb-free Reflow Profile

Power Systems will comply with J-STD-020 Rev. C (Moisture / Reflow Sensitivity Classification for Nonhermetic Solid State Surface Mount Devices) for both Pb-free solder profiles and MSL classification procedures. This standard provides a recommended forced-air-convection reflow profile based on the volume and thickness of the package (table 4-2). The suggested Pb-free solder paste is Sn/Ag/Cu (SAC). For questions regarding Land grid array (LGA) soldering, solder volume; please contact Lineage Power for special manufacturing process

instructions. The recommended linear reflow profile using Sn/Ag/Cu solder is shown in Fig-49. Soldering outside of the recommended profile requires testing to verify results and performance.

MSL Rating

The 12A Analog **Tomodachi** modules have a MSL rating of 2a.

Storage and Handling

The recommended storage environment and handling procedures for moisture-sensitive surface mount packages is detailed in J-STD-033 Rev. A (Handling, Packing, Shipping and Use of Moisture/Reflow Sensitive Surface Mount Devices). Moisture barrier bags (MBB) with desiccant are required for MSL ratings of 2 or greater. These sealed packages should not be broken until time of use. Once the original package is broken, the floor life of the product at conditions of $\leq 30^{\circ}\text{C}$ and 60% relative humidity varies according to the MSL rating (see J-STD-033A). The shelf life for dry packed SMT packages will be a minimum of 12 months from the bag seal date, when stored at the following conditions: $< 40^{\circ}\text{C}$, $< 90\%$ relative humidity.

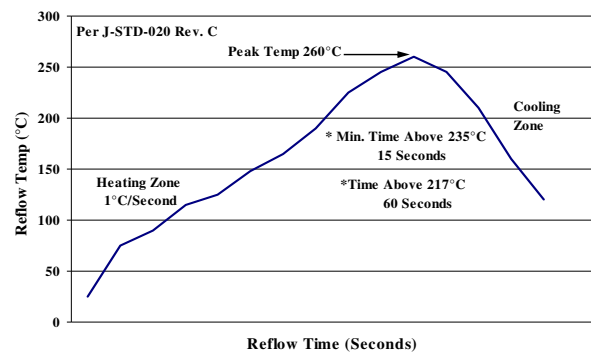

Fig-49: Recommended linear reflow profile using Sn/Ag/Cu solder.

Post Solder Cleaning and Drying Considerations

Post solder cleaning is usually the final circuit-board assembly process prior to electrical board testing. The result of inadequate cleaning and drying can affect both the reliability of a power module and the testability of the finished circuit-board assembly. For guidance on appropriate soldering, cleaning and drying procedures, refer to *Board Mounted Power Modules: Soldering and Cleaning Application Note (AN04-001)*.

FGSR12SR6012*A**Data Sheet**

3-14.4Vdc Input, 12A, 0.6-5.5Vdc Output

Part Number System

Product Series	Shape	Regulation	Input Voltage	Mounting Scheme	Output Voltage	Rated Current	ON/OFF Logic	Pin Shape
FG	S	R	12	S	R60	12	*	A
Series Name	Small	R: Regulated	Typ=12V	Surface Mount	0.60V (Programmable: See page 6)	12A	N: Negative P: Positive	Standard

Cautions

NUCLEAR AND MEDICAL APPLICATIONS: FDK Corporation products are not authorized for use as critical components in life support systems, equipment used in hazardous environments, or nuclear control systems without the written consent of FDK Corporation.

SPECIFICATION CHANGES AND REVISIONS: Specifications are version-controlled, but are subject to change without notice.