



Chipsmall Limited consists of a professional team with an average of over 10 year of expertise in the distribution of electronic components. Based in Hongkong, we have already established firm and mutual-benefit business relationships with customers from,Europe,America and south Asia,supplying obsolete and hard-to-find components to meet their specific needs.

With the principle of “Quality Parts,Customers Priority,Honest Operation,and Considerate Service”,our business mainly focus on the distribution of electronic components. Line cards we deal with include Microchip,ALPS,ROHM,Xilinx,Pulse,ON,Everlight and Freescale. Main products comprise IC,Modules,Potentiometer,IC Socket,Relay,Connector.Our parts cover such applications as commercial,industrial, and automotives areas.

We are looking forward to setting up business relationship with you and hope to provide you with the best service and solution. Let us make a better world for our industry!



Contact us

Tel: +86-755-8981 8866 Fax: +86-755-8427 6832

Email & Skype: info@chipsmall.com Web: www.chipsmall.com

Address: A1208, Overseas Decoration Building, #122 Zhenhua RD., Futian, Shenzhen, China



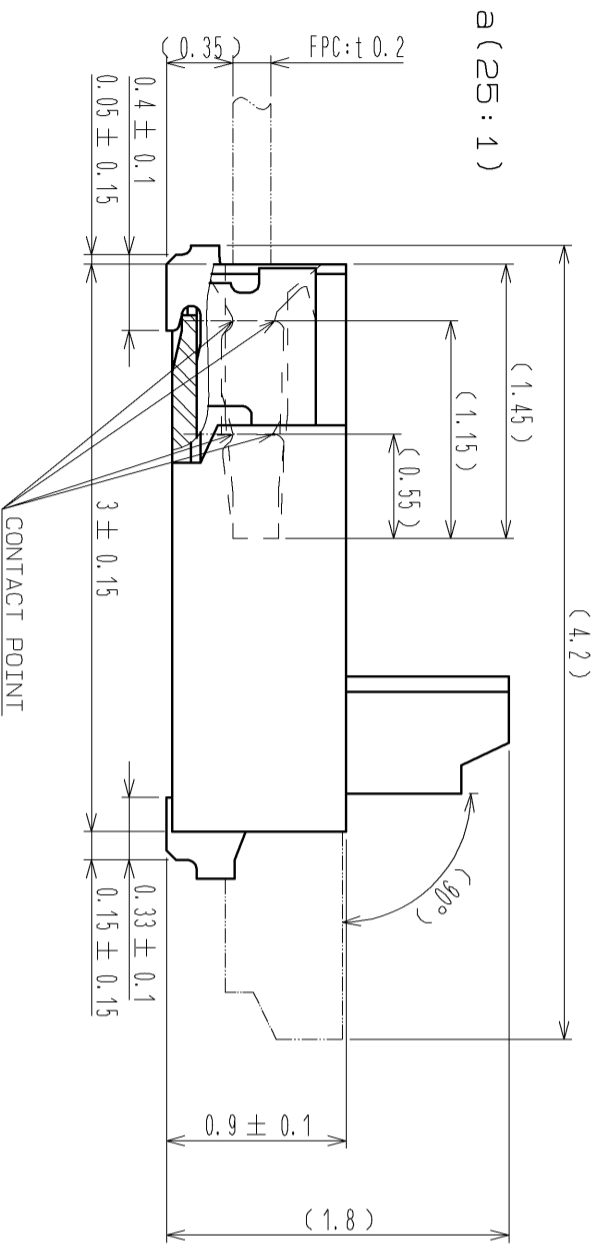
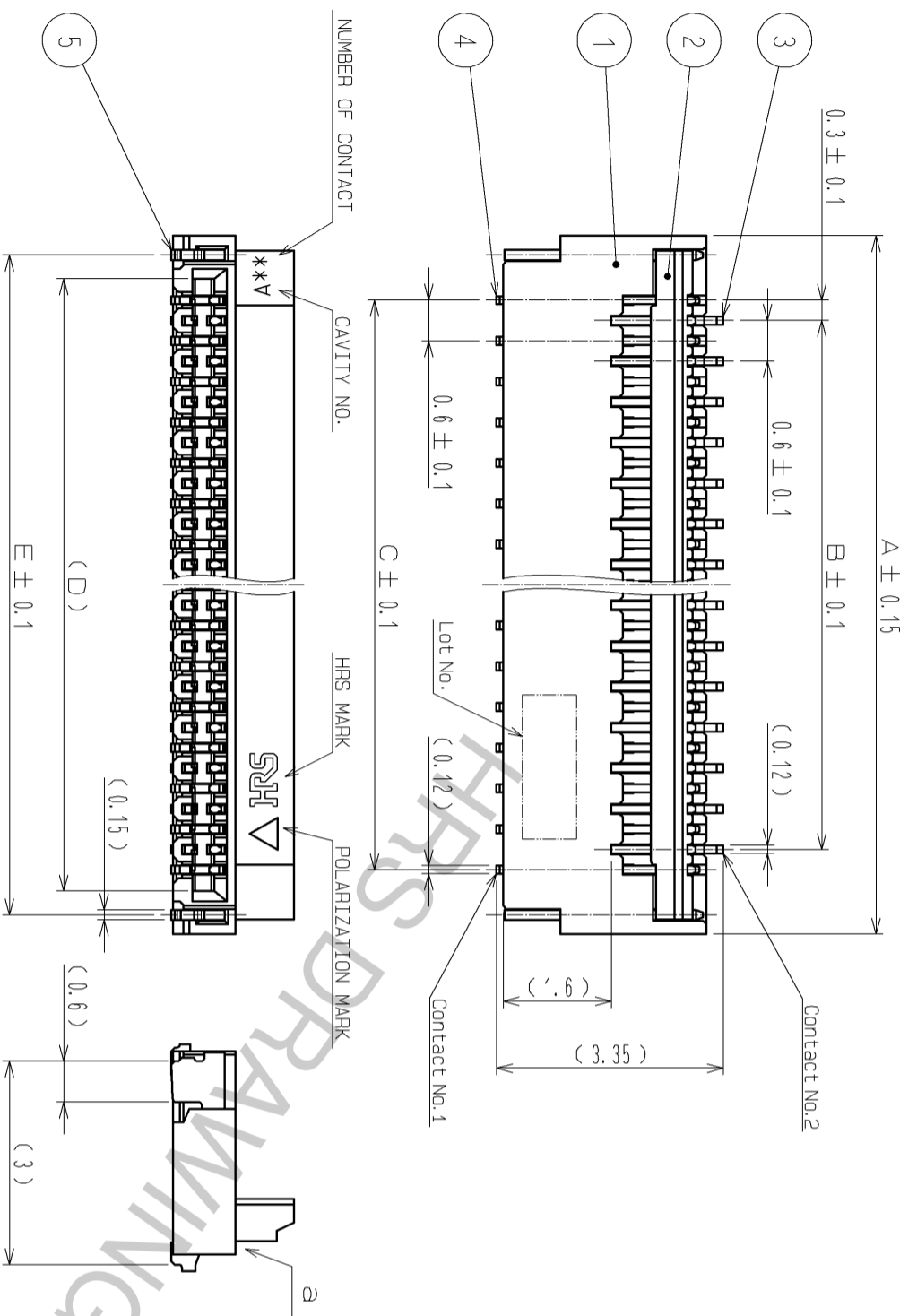

- NOTE
1. The dimensions in parentheses are for reference.
 2. Lead Co-Planarity including reinforced metal fittings shall be 0.1 MAX.
 3. To be delivered with tape and reel packages.
 4. See attached packaging specifications for details.
 5. Note that preventive hole for sink mark could be added for improvement.
 6. The quality remains good, even with the dark spots, which could occasionally occur on molded plastic.
 7. This product satisfies halogen free requirements defined as 900ppm maximum chlorine, 900ppm maximum bromine, and 1500ppm maximum total of chlorine and bromine.
 8. 'n' represents the number of contacts.

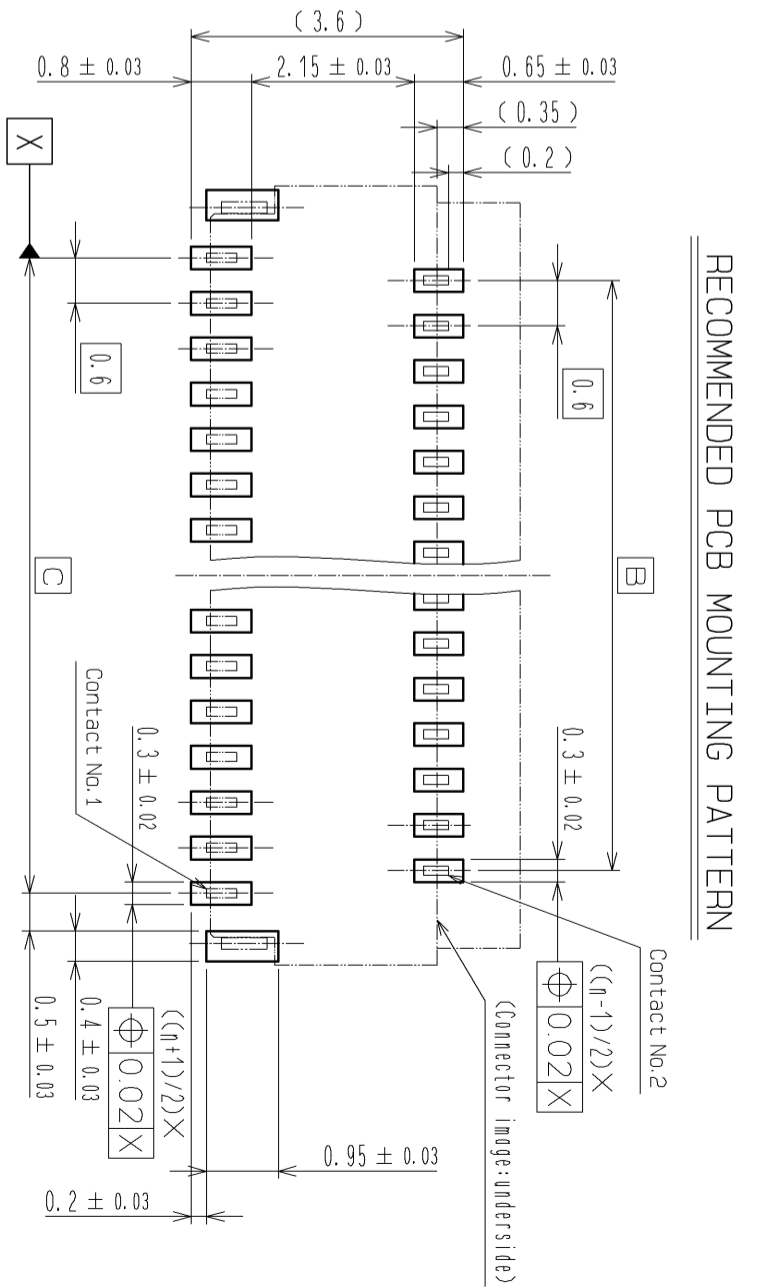

RECOMMENDED STENCIL PATTERN
(RECOMMENDED STENCIL THICKNESS: t=0.1)

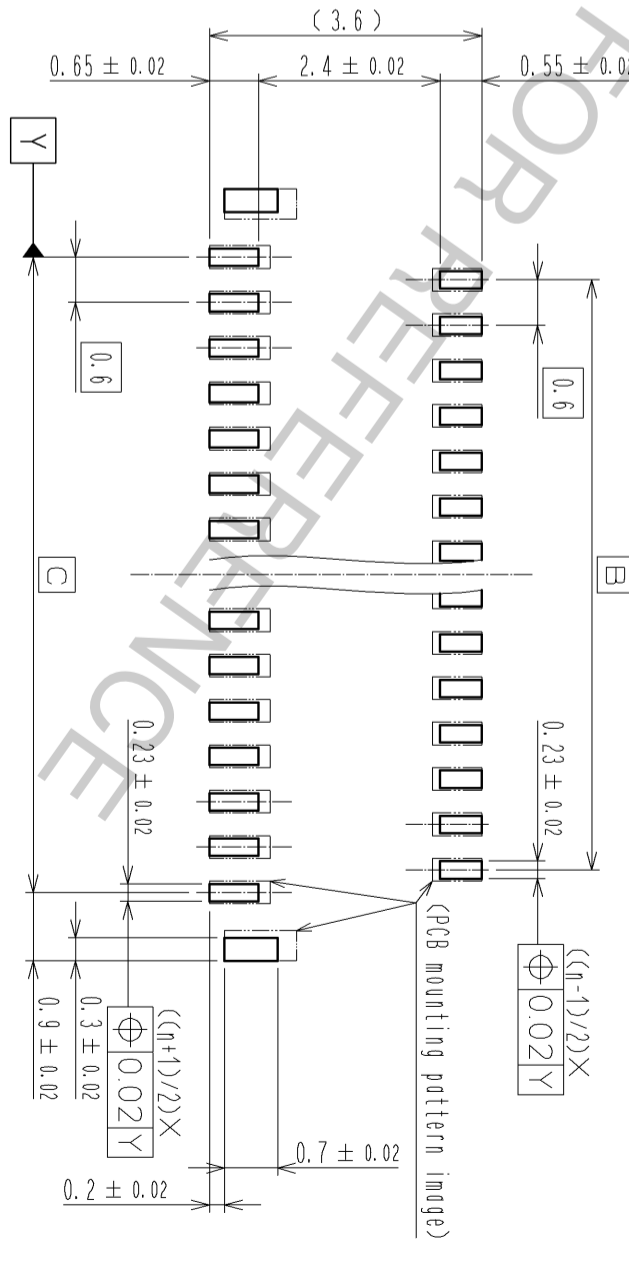

4	PHOSPHOR BRONZE	(CONTACT AREA LEAD GOLD 0.03µm MIN OVER NICKEL 1µm MIN)	9	(CONNECTOR)	
3	PHOSPHOR BRONZE	(OTHER NICKEL PLATING 1µm MIN)	8	POLYSTYRENE	
2	PA	(CONTACT AREA LEAD GOLD 0.03µm MIN OVER NICKEL 1µm MIN)	7	POLYESTER	
1	LCP	(OTHER NICKEL PLATING 1µm MIN)	6	POLYSTYRENE	
			5	PHOSPHOR BRONZE (PLATED MATERIAL)	TIN PLATING (REFLOW FINISHED) 1µm MIN OVER COPPER 0.5µm MIN

UNITS	mm	SCALE	10:1	COUNT	2	DESCRIPTION OF REVISIONS	DIS-F-007776	DESIGNED	YV. TAKASHITA	CHECKED	YN. TAKASHITA	DATE	14.12.17
APPROVED	NM. NISHIMATSU	11.06.13	DRAWING NO.	EDC3-338903-01									
CHECKED	FN. TAMURA	11.06.10	PART NO.	FH35C-**S-0.3SHW(50)									
DESIGNED	HH. MURAKAMI	11.06.09	CODE	CL580									
DRAWN	HH. MURAKAMI	11.06.09	NO.	1/6									

RECOMMENDED FPC (15:1)

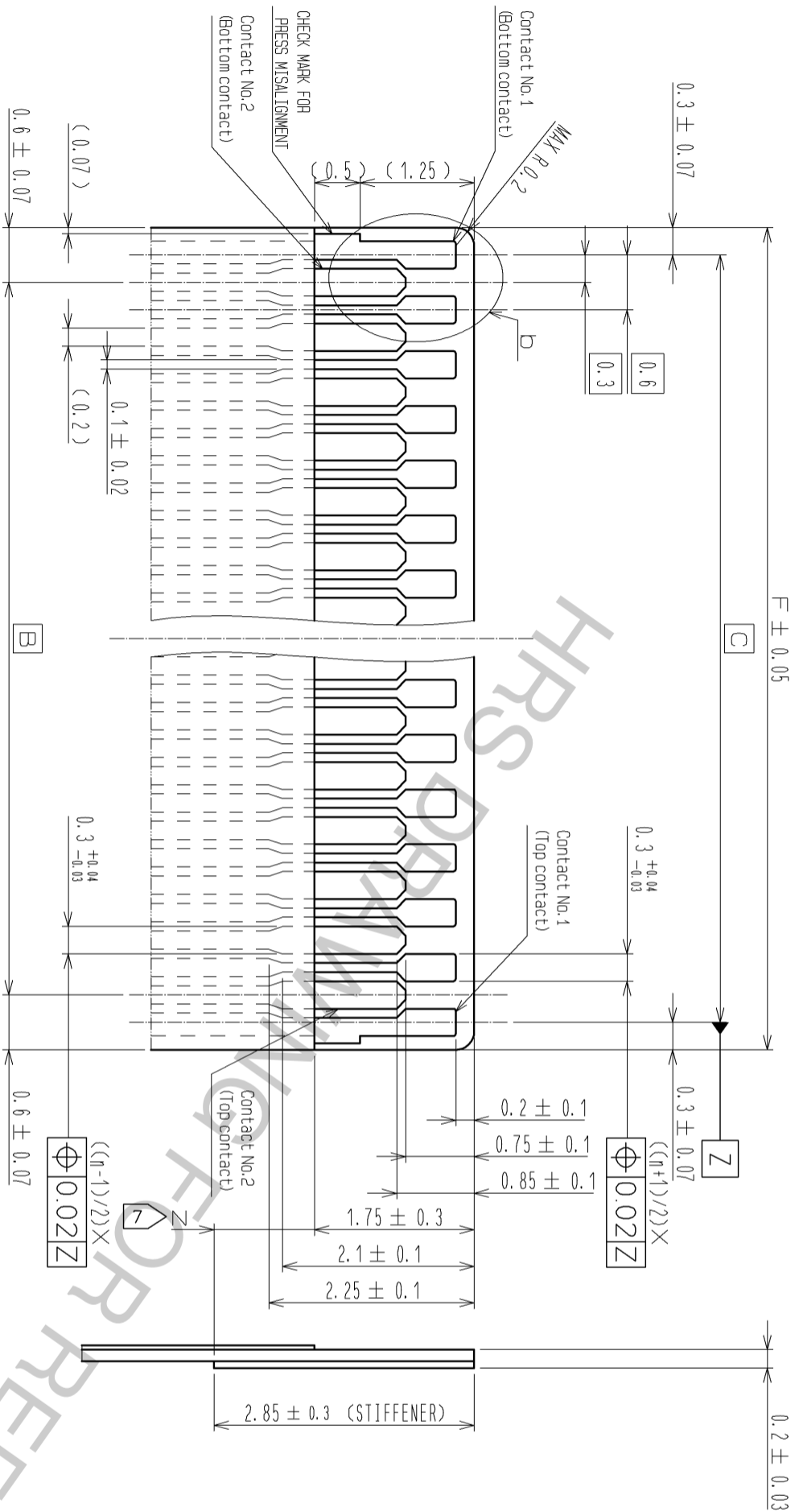

NOTE 7 On your designing the FPC, make sure that dimension N shall be 0.5 mm or more.

FPC CONFIGURATION (REFERENCE EXAMPLE)

(SCALE: FREE)

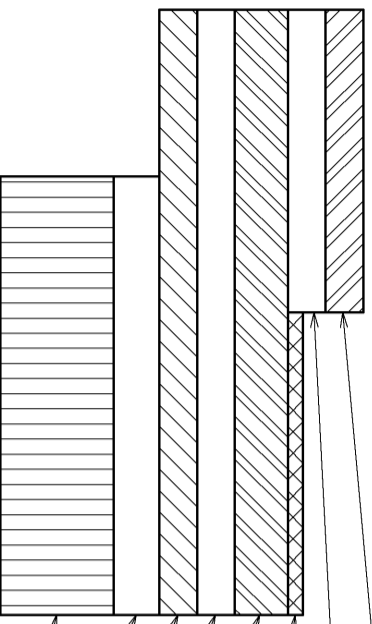

MATERIAL NAME	MATERIAL	THICKNESS (µm)
COVERING FILM LAYER	POLYIMIDE 1µm1 thick.	25
COVER ADHESIVE		25
SURFACE TREATMENT	1µm to 5µm NICKEL UNDERPLATED 0.2µm GOLD PLATED	(3)
COPPER FOIL	Cu 1 OZ	35
BASE ADHESIVE	HEAT-HARDENED ADHESIVE	25
BASE FILM	POLYIMIDE 1µm1 thick	25
REINFORCEMENT MATERIAL ADHESIVE	HEAT-HARDENED ADHESIVE	40
STIFFENER	POLYIMIDE 3µm1 thick	75

EMBOSSED CARRIER TAPE DIMENSION (2:1)

⑨ 24mmMAX

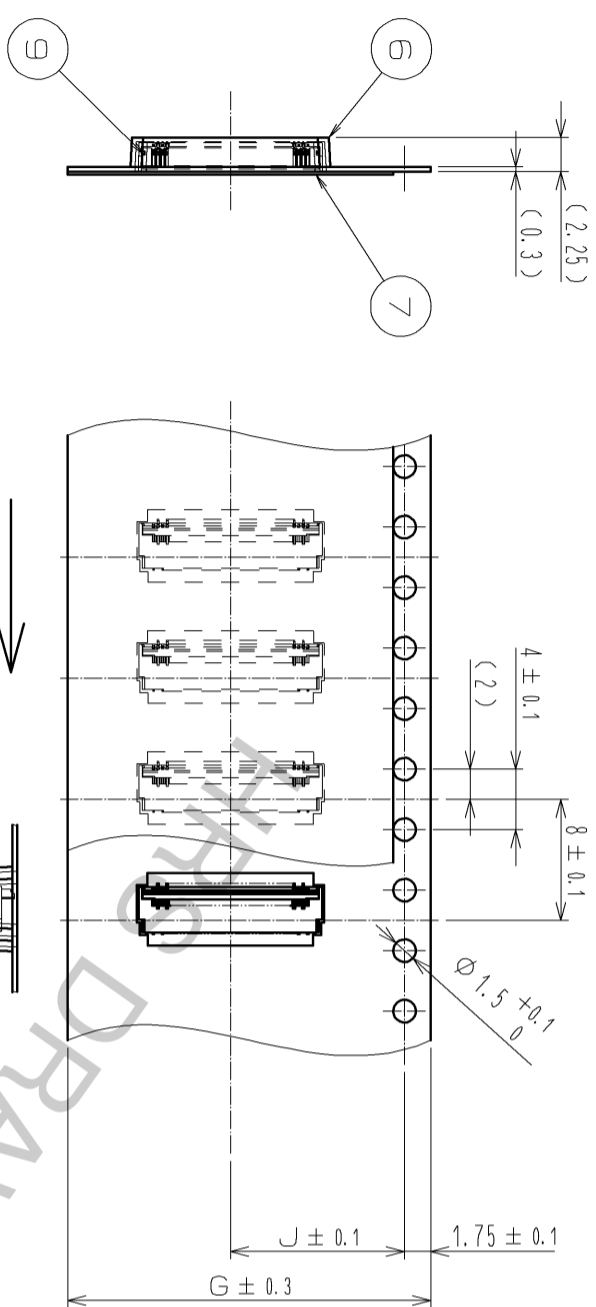

⑧ 32mmMIN

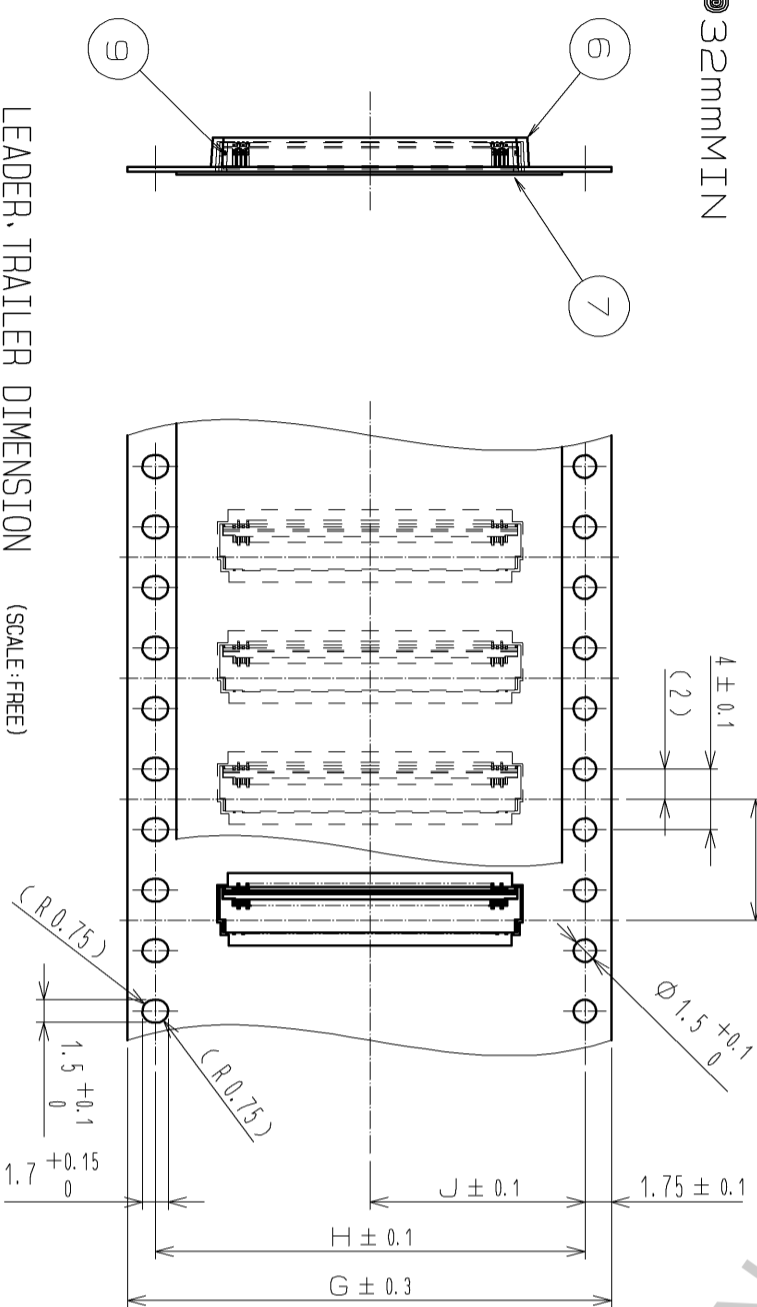

LEADER, TRAILER DIMENSION (SCALE:FREE)

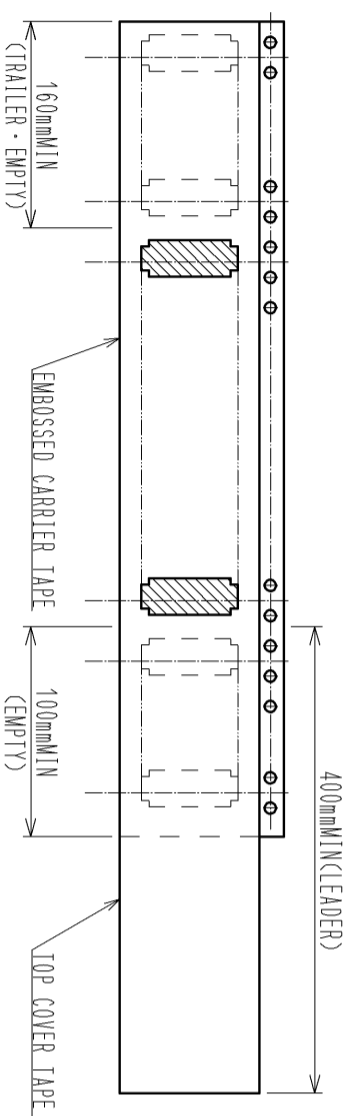

REEL DIMENSION (SCALE:FREE)

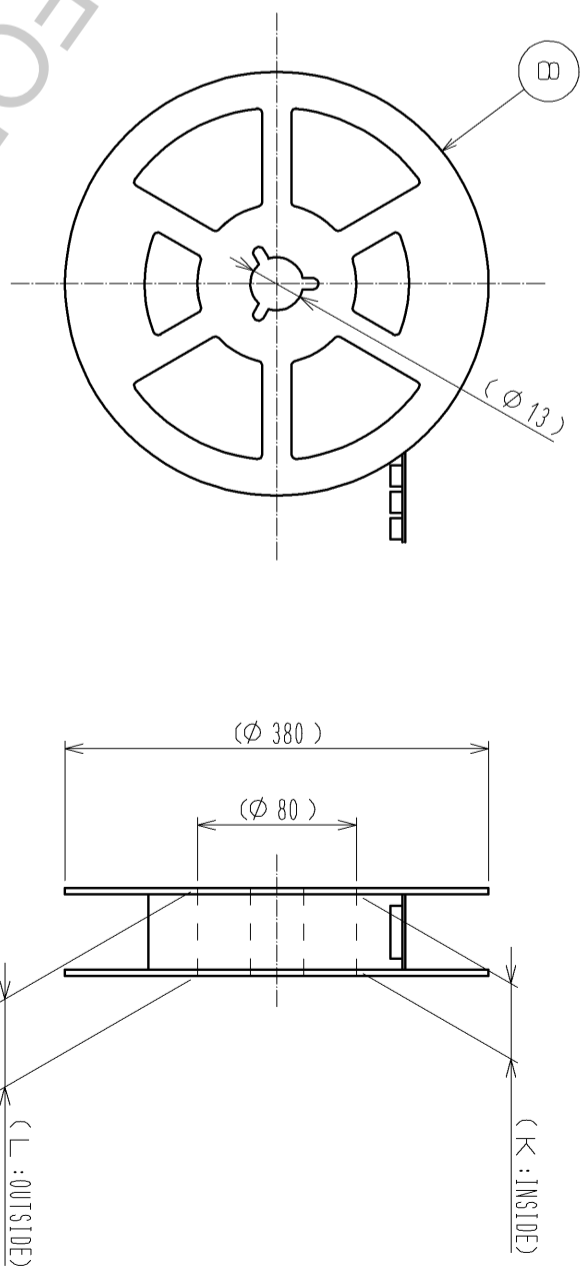

NOTE 8 Per reel : 5000 connectors.

9 Refer to JIS C 0806

(Packaging of components for automatic handling.)

REFERENCE

FORM HC0011-5-8

HRS	
DRAWING NO.	EDC3-338903-01
PART NO.	FH35C-**-S-0.3SHW(50)
CODE NO.	CL580
	4/3/6

PART NUMBER	CODE NUMBER	NUMBER OF CONTACTS	DIMENSION OF CONNECTOR, PFG, PCB MOUNTING PATTERN AND STENCIL												DIMENSION OF DRAWING FOR PACKING					
			A	B	C	D	E	F	G	H	J	K	L	G	H	J	K	L		
FH35C-9S-0.3SHW(50)	CL580-2910-5-50	9	4.3	1.8	2.4	3.03	3.73	3.0	16	-	7.5	17.4	21.4							
FH35C-11S-0.3SHW(50)	CL580-2917-4-50	11	4.9	2.4	3.0	3.63	4.33	3.6	16	-	7.5	17.4	21.4							
FH35C-13S-0.3SHW(50)	CL580-2925-2-50	13	5.5	3.0	3.6	4.23	4.93	4.2	16	-	7.5	17.4	21.4							
FH35C-15S-0.3SHW(50)	CL580-2919-0-50	15	6.1	3.6	4.2	4.83	5.53	4.8	16	-	7.5	17.4	21.4							
FH35C-17S-0.3SHW(50)	CL580-2916-1-50	17	6.7	4.2	4.8	5.43	6.13	5.4	16	-	7.5	17.4	21.4							
FH35C-19S-0.3SHW(50)	CL580-2921-1-50	19	7.3	4.8	5.4	6.03	6.73	6.0	16	-	7.5	17.4	21.4							
FH35C-21S-0.3SHW(50)	CL580-2922-4-50	21	7.9	5.4	6.0	6.63	7.33	6.6	24	-	11.5	25.4	29.4							
FH35C-23S-0.3SHW(50)	CL580-2911-8-50	23	8.5	6.0	6.6	7.23	7.93	7.2	24	-	11.5	25.4	29.4							
FH35C-25S-0.3SHW(50)	CL580-2912-0-50	25	9.1	6.6	7.2	7.83	8.53	7.8	24	-	11.5	25.4	29.4							
FH35C-27S-0.3SHW(50)	CL580-2918-7-50	27	9.7	7.2	7.8	8.43	9.13	8.4	24	-	11.5	25.4	29.4							
FH35C-31S-0.3SHW(50)	CL580-2923-7-50	31	10.9	8.4	9.0	9.63	10.33	9.6	24	-	11.5	25.4	29.4							
FH35C-33S-0.3SHW(50)	CL580-2913-3-50	33	11.5	9.0	9.6	10.23	10.93	10.2	24	-	11.5	25.4	29.4							
FH35C-35S-0.3SHW(50)	CL580-2926-5-50	35	12.1	9.6	10.2	10.83	11.53	10.8	24	-	11.5	25.4	29.4							
FH35C-37S-0.3SHW(50)	CL580-2914-6-50	37	12.7	10.2	10.8	11.43	12.13	11.4	24	-	11.5	25.4	29.4							
FH35C-39S-0.3SHW(50)	CL580-2915-9-50	39	13.3	10.8	11.4	12.03	12.73	12.0	24	-	11.5	25.4	29.4							
FH35C-41S-0.3SHW(50)	CL580-2924-0-50	41	13.9	11.4	12.0	12.63	13.33	12.6	24	-	11.5	25.4	29.4							
FH35C-45S-0.3SHW(50)	CL580-2909-6-50	45	15.1	12.6	13.2	13.83	14.53	13.8	24	-	11.5	25.4	29.4							
FH35C-49S-0.3SHW(50)	CL580-2927-8-50	49	16.3	13.8	14.4	15.03	15.73	15.0	32	28.4	14.2	33.4	37.4							
FH35C-51S-0.3SHW(50)	CL580-2920-9-50	51	16.9	14.4	15.0	15.63	16.33	15.6	32	28.4	14.2	33.4	37.4							
FH35C-55S-0.3SHW(50)	CL580-2931-5-50	55	18.1	15.6	16.2	16.83	17.53	16.8	32	28.4	14.2	33.4	37.4							
FH35C-61S-0.3SHW(50)	CL580-2928-0-50	61	19.9	17.4	18.0	18.63	19.33	18.6	32	28.4	14.2	33.4	37.4							

DRAWING NO.		EDC3-338903-01	
PART NO.		FH35C-**S-0.3SHW(50)	
CODE NO.		CL580	

This connector features small, thin and back flip design, requiring delicate and careful handling.
Read through the instructions shown below and handle the connector properly.

[Operation and Precautions]

1. Initial condition

Actuator does not have to be operated before inserting FPC, as the connector is delivered with the actuator opened.

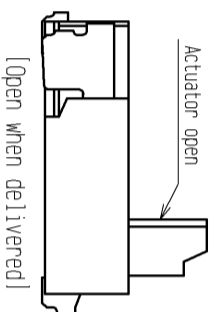

4. How to Lock

Apply load to rotate the actuator by 90 degree after inserting the FPC.

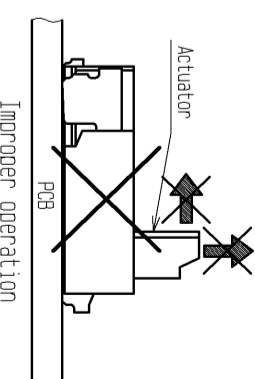
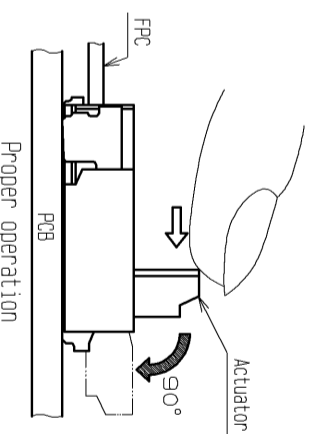
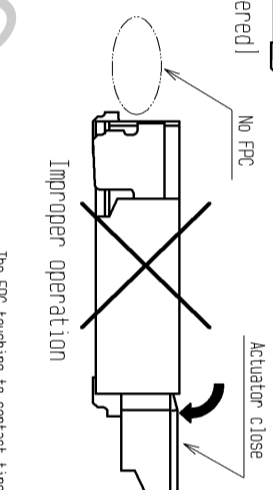

[Prohibited acts]
-Do not close the actuator before inserting FPC.
Closing the actuator without FPC could make the contact gap smaller, which could increase the FPC insertion force when FPC is inserted. (Figure:1)
Do not insert the FPC at a sharp angle as this may cause contact deformation by the FPC touching to contact tips. (Figure:2)

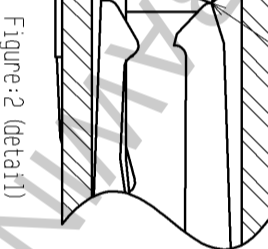
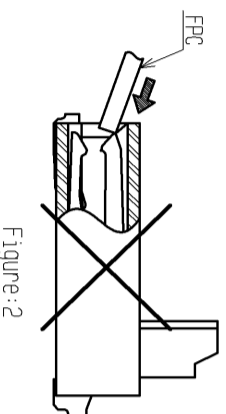
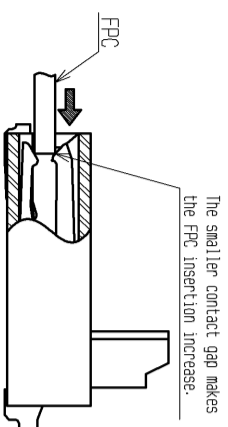

[Caution]

-The actuator rotates around the rotational axis as shown below.
-Do not rotate the actuator to the counter direction.
-Do not pinch or pick the actuator to lift. Otherwise, it may break.
-Apply load to the mid-point on the actuator to rotate it.
-Do not apply force to side end of the actuator. Uneven load could twist the actuator and cause half mating.
-Do not apply excess force to the housing during the operation.

[Caution]

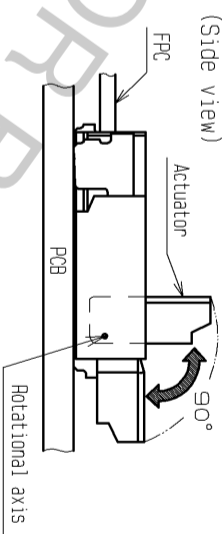

[Caution]

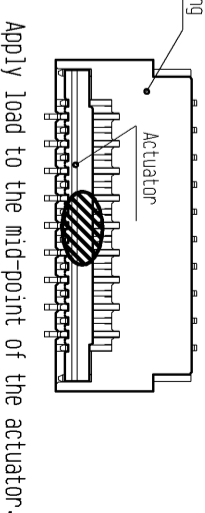

2. How to insert FPC

Insert the FPC into the connector opening horizontally to the board plane. Insert it properly to the very end.

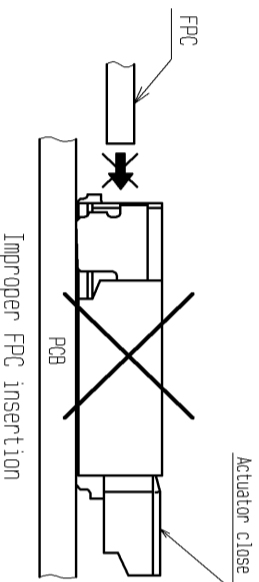
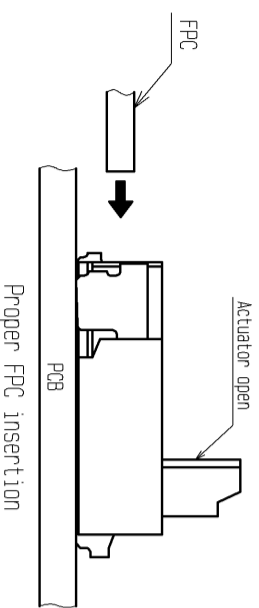

5. How to remove FPC (How to unlock)

Slowly flip up the actuator to release the lock and remove the FPC.

[Caution]

-The actuator is opened up to the movable limit, 90 degree.
-Do not open the actuator beyond the specified degree or apply excess force to the actuator.
-To open the actuator, operate at the mid-point of the actuator. Do not lift up the side end of the actuator, or it may twist the actuator and cause breakage.
-Please note that the connector is back flip style connector, and the opening for FPC insertion and the actuator face the opposite direction. Do not try to lift the actuator at the FPC insertion opening side.
-Do not press down the actuator toward connector when operating. Otherwise it could deform the contact.

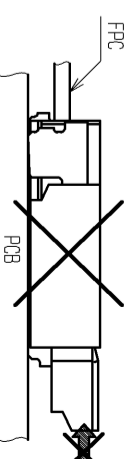
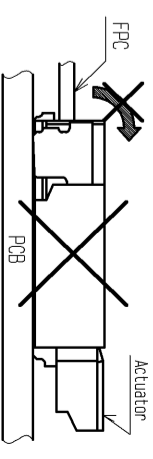
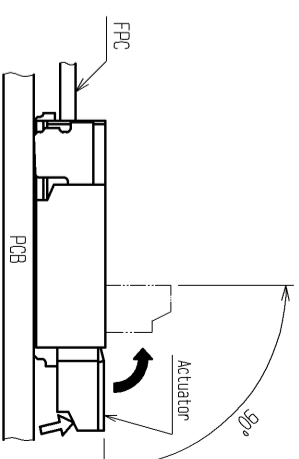

3. FPC insertion check (for using contacts on the top; for FPC pattern only applicable to FH35)

Improper assembly modes are prevented by visual check, comparing positions of housing opening end line and FPC pattern line.

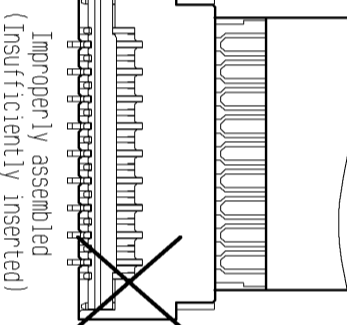
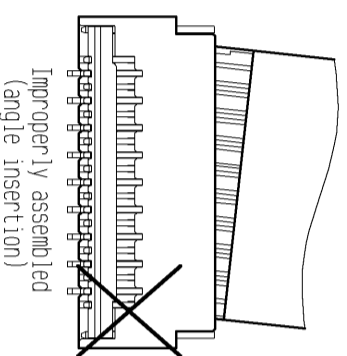
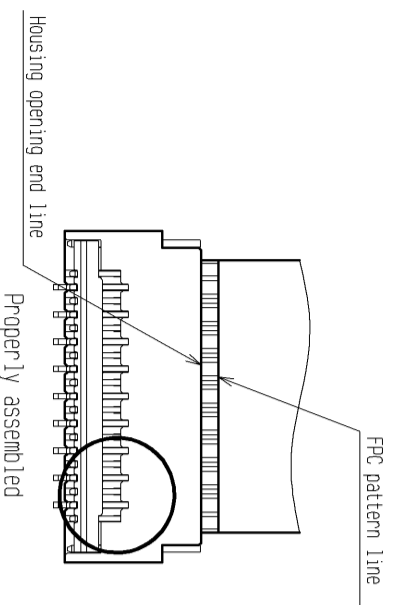

HRS	
DRAWING NO.	EDC3-338903-01
PART NO.	FH35C-**-S-0.3SHW(50)
CODE	CL580
NO.	4/5

This connector features small, thin and back flip design, requiring delicate and careful handling. Read through the instructions shown below and handle the connector properly.

6.How to FPC routing

Do not apply load to FPC when locating FPC.

It leads to the disconnection break or damage of FPC.

In addition, there is possibility to make a conduction failure if applying load to connector.

[Prohibited acts]

- Please design FPC routing so that FPC stiffener will not interfere with cover case.
- When fixing FPC, avoid applying forces to FPC in vertical or horizontal directions.
- In addition, avoid pulling up and down on the FPC.
- When fixing FPC after FPC cabling, avoid pulling FPC, and route the wire FPC with slack.
- In this regard, the stiffener is parallel to the PCB.
- Do not mount other components touching to the FPC underneath the FPC stiffener.

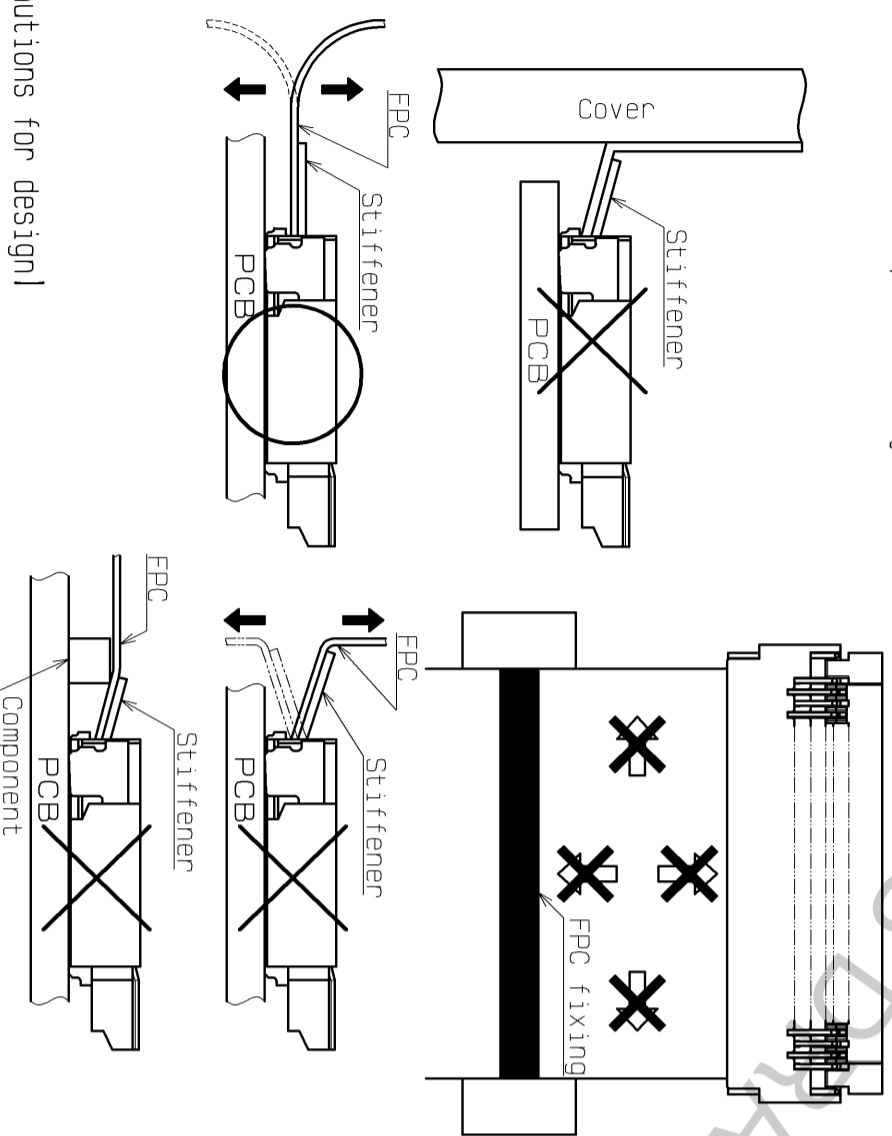

[Precautions for design]

1. During FPC wiring, ensure that stress is not applied directly to the connector. Do not bend the FPC excessively near the connector during use, or it may cause contact failure or FPC breakage. Stabilizing the FPC is recommended.

2. Keep a sufficient FPC insertion space in the stage of the layout in order to avoid incorrect FPC insertion. Appropriate FPC length and component layout are recommended for assembly ease. Too short FPC length makes assembly difficult.

3. Follow the recommended PCB layout, FPC design and the stencil opening design.

4. Make adjustments with the FPC manufacturer for FPC bending performance and wire breakage.

5. Keep spaces for the actuator movement and its operation for PCB design and component layout.

Instructions for mounting on the PCB

◆Warp of PCB

Minimize warp of the PCB as much as possible. Lead co-planarity including reinforced metal fittings is 0.1 mm or less. Too much warp of the PCB may result in a soldering failure.

◆Flexible board design

Please make sure to put a stiffener on the backside of the flexible board. We recommend a glass epoxy material with the thickness of 0.3mm MIN.

◆Load to Connector

Do not add 0.5N or greater external force when unreel or pick and place the connector etc. or it may get broken. In addition, do not insert the FPC or operate the connector before mounting.

◆Reflow temperature profile

Apply reflow temperature profile within the specified conditions. In individual applications, the actual temperature may vary, depending on solder paste type, volume/thickness and PCB size/thickness. Consult your solder paste and equipment manufacturer for specific recommendations.

INSTRUCTIONS FOR PCB HANDLING AFTER MOUNTING THE CONNECTOR

◆Load to PCB

◆Splitting a large PCB into several pieces
 ◆Screwing the PCB
 Avoid the handling described above so that no force is exerted on the PCB during the assembly process. Otherwise, the connector may become defective.

◆Amount of Warp

The warp of a 100mm wide PCB should be 0.5 mm or less. The warp of PCB suffers stress on connector and the connector may become defective.

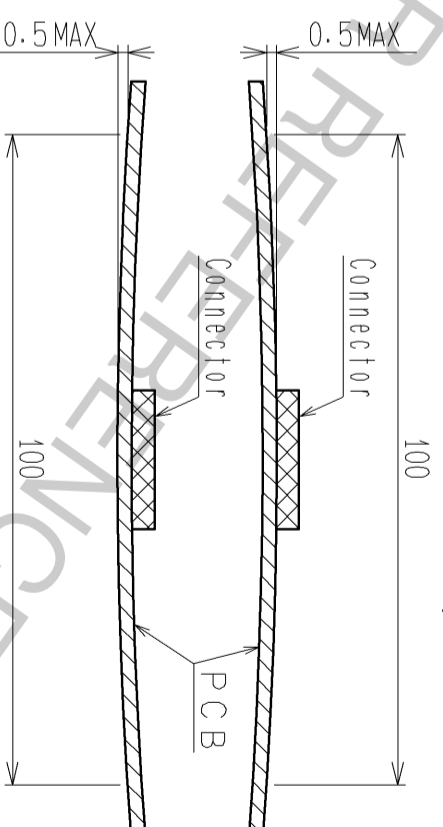

[Other instructions]

◆Instructions on manual soldering
 Follow the instructions shown below when soldering the connector manually during repair work, etc.

1. Do not perform manual soldering with the FPC inserted into the connector.
2. Do not heat the connector excessively. Be very careful not to let the soldering iron contact any parts other than connector leads. Otherwise, the connector may be deformed or melt.
3. Do not supply excessive solder (or flux).
 If excessive solder (or flux) is supplied on the terminals, solder or flux may adhere to the contacts or rotating parts of the actuator, resulting in poor contact or a rotation failure of the actuator. Supplying excessive solder to the metal fittings may hinder actuator rotation, resulting in breakage of the connector.

		DRAWING NO.	EDC3-338903-01
		PART NO.	FH35C-**-S-0.3SHW(50)
		CODE	CL580
		NO.	4/6