



Chipsmall Limited consists of a professional team with an average of over 10 year of expertise in the distribution of electronic components. Based in Hongkong, we have already established firm and mutual-benefit business relationships with customers from,Europe,America and south Asia,supplying obsolete and hard-to-find components to meet their specific needs.

With the principle of “Quality Parts,Customers Priority,Honest Operation,and Considerate Service”,our business mainly focus on the distribution of electronic components. Line cards we deal with include Microchip,ALPS,ROHM,Xilinx,Pulse,ON,Everlight and Freescale. Main products comprise IC,Modules,Potentiometer,IC Socket,Relay,Connector.Our parts cover such applications as commercial,industrial, and automotives areas.

We are looking forward to setting up business relationship with you and hope to provide you with the best service and solution. Let us make a better world for our industry!



## Contact us

Tel: +86-755-8981 8866 Fax: +86-755-8427 6832

Email & Skype: info@chipsmall.com Web: www.chipsmall.com

Address: A1208, Overseas Decoration Building, #122 Zhenhua RD., Futian, Shenzhen, China



# PSE Technology Corporation

## SPECIFICATION FOR APPROVAL

CUSTOMER	_____
NOMINAL FREQUENCY	<b>37.400000 MHz</b>
PRODUCT TYPE	<b>TYPE FH 2.5x2.0 SEAM SEALED CRYSTAL</b>
PART NUMBER	<b>FH3740013Z</b>
CUSTOMER P/N	_____
ISSUE DATE	<b>August 20, 2014</b>
VERSION	<b>B</b>

APPROVED	PREPARED	QA
<i>Brenda</i>	<i>Nikhi Lu</i>	<i>Becky Lin</i>
APPROVED BY CUSTOMER		
Please return one copy with approval to PSE-TW		

### PSE Technology Corporation

No.2, Tzu-Chiang 5th Rd., Chung Li Industrial Park,  
 Chung Li City, Taoyuan County, Taiwan (R.O.C.)  
 TEL:886-3-451-8888  
 FAX:886-3-461-3865  
<http://www.saronix-ecera.com.tw/>

- \*Pb-free
- \*RoHS Compliant
- \*HF-Halogen Free
- \*REACH Compliant

**A Company of PERICOM Semiconductor Corporation**

# TYPE FH 2.5x2.0 SEAM SEALED CRYSTAL

## ***FH3740013Z***

VER.B 20-AUG-14

### VERSION HISTORY

Version No.	Version Date	Customer Receipt Date	Supplier Receipt Date	Description	Notes
A	Aug. 19, 2014			Initial Release	
B	Aug. 20, 2014			Updated to Frequency Stability +/-10ppm, Operating Drive Level 100uW , Maximum Drive Level 150uW, ESR 10ohms typ / 30ohms max , C0 3pF & aging +/-1ppm.	

# TYPE FH 2.5x2.0 SEAM SEALED CRYSTAL

## FH3740013Z

VER.B 20-AUG-14

### ELECTRICAL SPECIFICATIONS

Item	Symbol	Specifications	Units	Notes
Nominal Frequency	Fn	37.400000	MHz	
Mode of Oscillation	MO	AT Cut-Fundamental		
Calibration Load Capacitance	CL	8	pF	
Calibration Tolerance	FL	± 10	ppm	at 25°C±3°C
Operating Temperature Range	TR	-30 to +85	°C	
Frequency Stability(Frequency Deviation over the Operating Temperature Range)	F/T	± 10	ppm	Reference to the Frequency at 25°C
Operating Drive Level		100	μW	
Maximum Drive Level		150	μW	
Equivalent Series Resistance	ESR	10 / 30	Ω	Typ. / Max.
Shunt Capacitance	C0	3	pF	Max.
Aging at 25°C		± 1	ppm	Max, 1st year
Storage Temperature		-55 to +125	°C	
Insulation Resistance		500	MΩ	Min

\*\* This product doesn't include harmful substance that stipulated by SONY SS-00259 Level 1 and S-AT2-001 Level 1 standard. RoHS Compliant (Pb - Free).



# TYPE FH 2.5x2.0 SEAM SEALED CRYSTAL

**FH3740013Z**

VER.B 20-AUG-14

## RELIABILITY SPECIFICATIONS

### MECHANICAL AND ENVIRONMENTAL RATINGS:

- a) FINE LEAK TEST: JESD22-A109 (Condition 1A)
- b) GROSS LEAK TEST: JESD22-A109 (Condition C)
- c) MOISTURE RESISTANCE: JESD22-A113
- d) SHOCK: JESD22-B104 (Condition B)
- e) SOLDERABILITY : (RoHS version): J-STD-002
- f) VIBRATION: JESD22-B103
- g) SOLVENT RESISTANCE: JESD22-B107
- h) RESISTANCE TO SOLDERING HEAT (RoHS version): J-STD-020D Table 5.2 Pb free devices (3 cycles max)

## SUGGESTED IR REFLOW PROFILE

\*As per IPC-JEDEC J-STD-020D

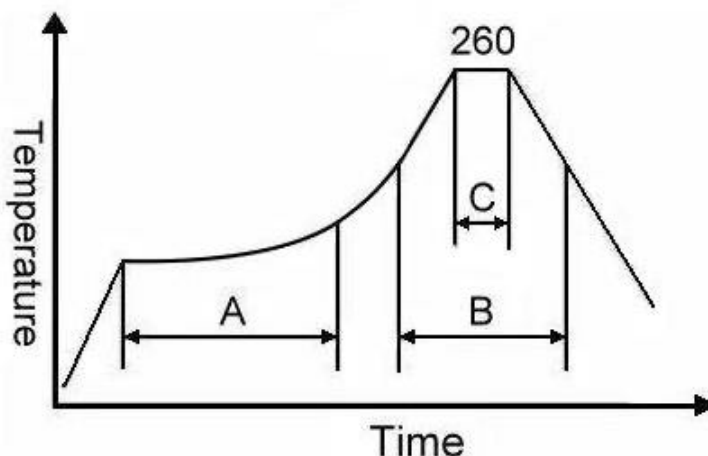

Note:

	Stage	Temperature	Time
A	Preheat	150~200°C	60~120 Sec
B	Primary Heat	217°C	60~150 Sec
C	Peak	260°C	10 Sec

For soldering reflow profile and reliability test ratings go to: <http://www.pericom.com/pdf/sre/reflow.pdf>

# TYPE FH 2.5x2.0 SEAM SEALED CRYSTAL

## FH3740013Z

VER.B 20-AUG-14

### MARKING

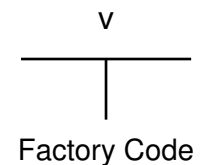
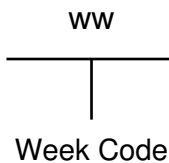
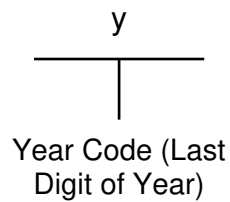
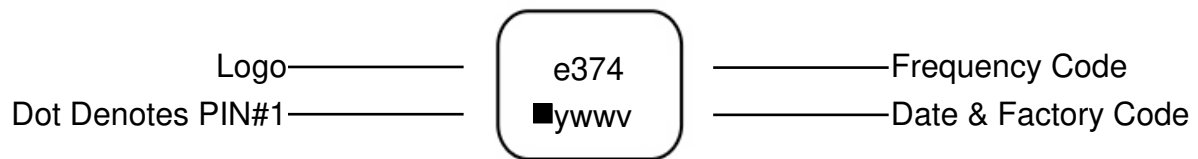

### MECHANICAL DRAWINGS ( Scale: None. Dimensions are in mm.)

Recommended Land Pattern

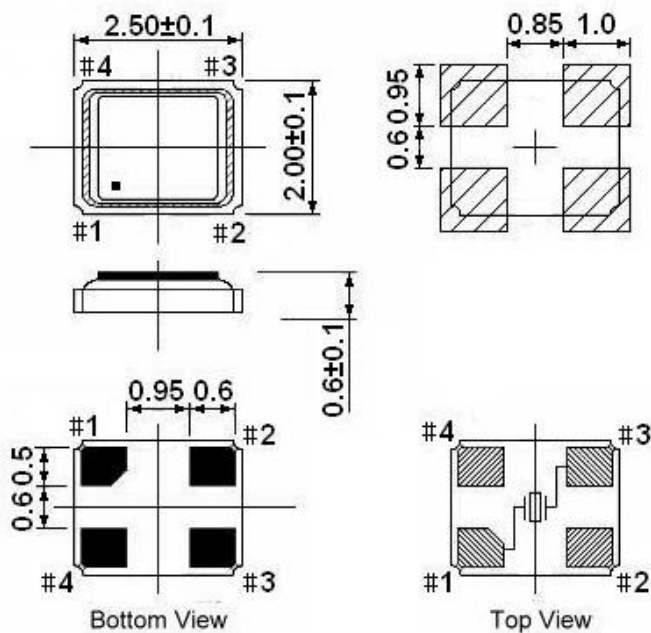

\*\* Recommended - Pin 1 & 3 : CRYSTAL  
Pin 2 & 4 : GND

#### Notes:

1. Package drawings are for reference only, and the appearances of objects may vary. Actual packages are based on the real product.
2. The marking dot denotes Pin#1.
3. The position and shape of the chamfer pin may vary and are based on the real product.



# TYPE FH 2.5x2.0 SEAM SEALED CRYSTAL

## FH3740013Z

VER.B 20-AUG-14

### PACKING

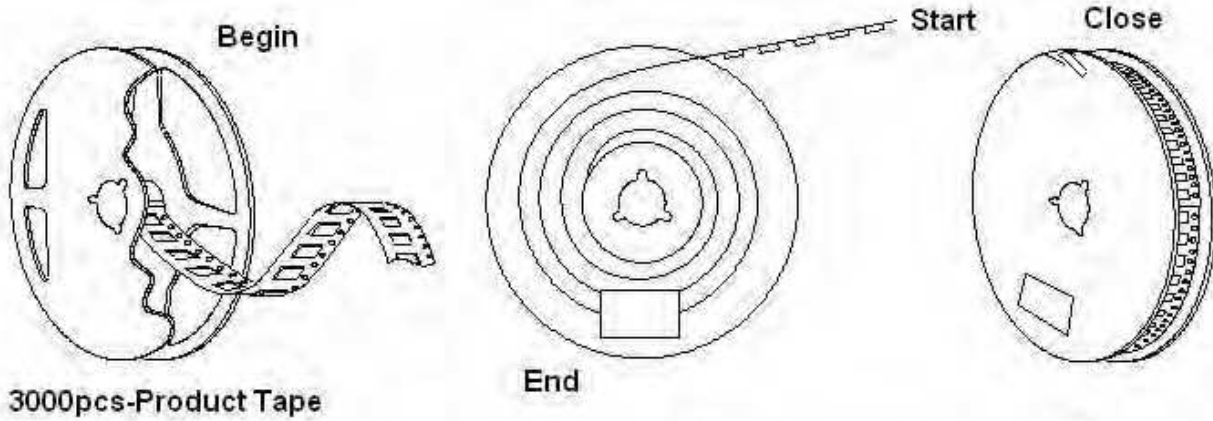

3000pcs-Product Tape

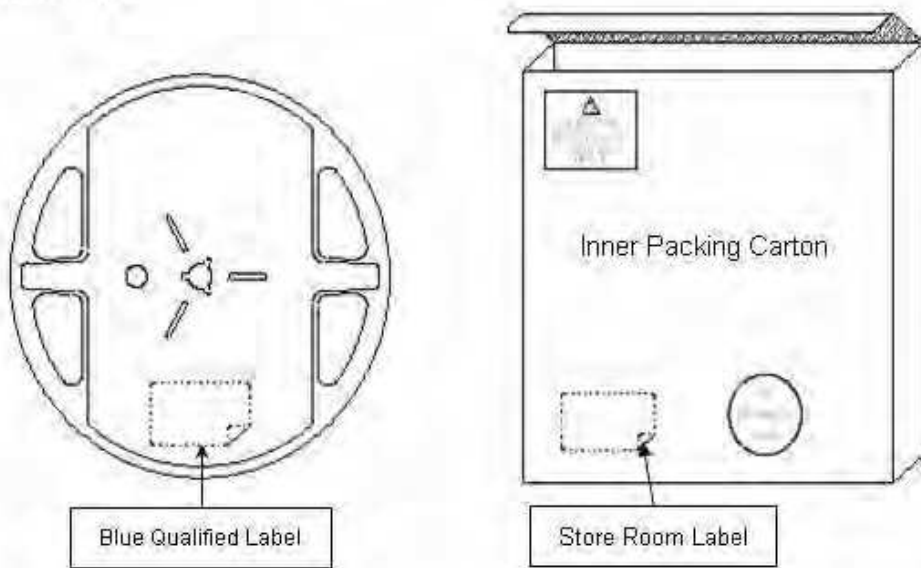

Blue Qualified Label

Store Room Label

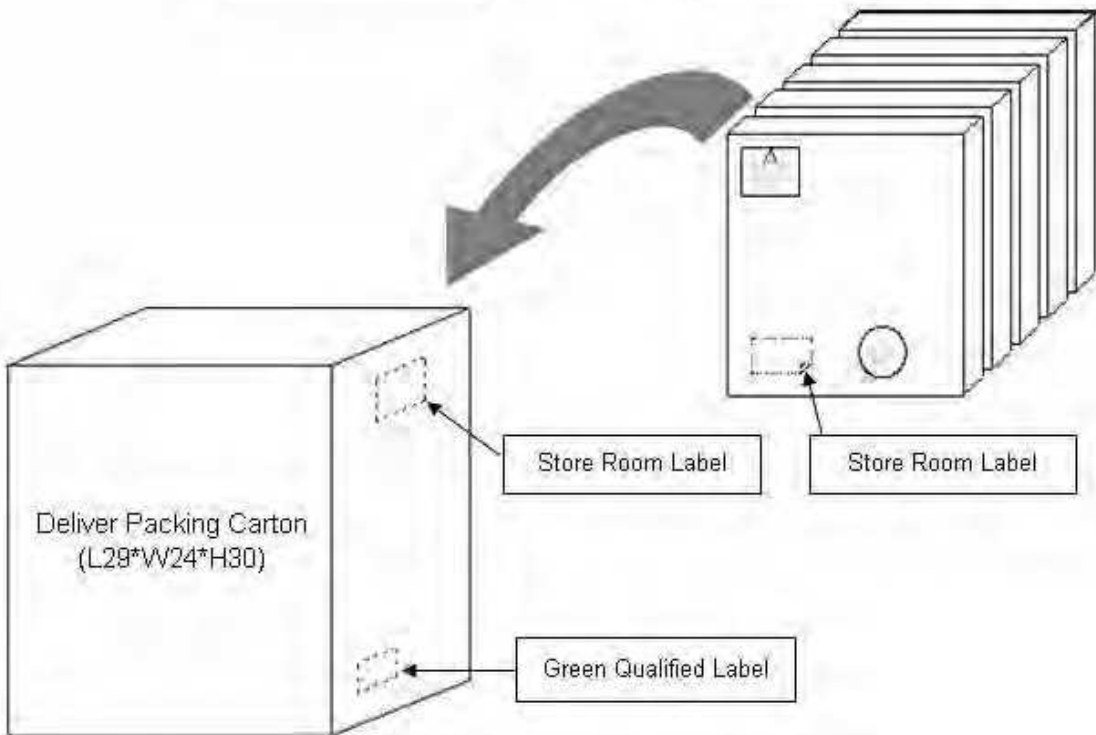

Store Room Label

Store Room Label

Green Qualified Label

Deliver Packing Carton  
(L29\*W24\*H30)