



Chipsmall Limited consists of a professional team with an average of over 10 year of expertise in the distribution of electronic components. Based in Hongkong, we have already established firm and mutual-benefit business relationships with customers from,Europe,America and south Asia,supplying obsolete and hard-to-find components to meet their specific needs.

With the principle of “Quality Parts,Customers Priority,Honest Operation,and Considerate Service”,our business mainly focus on the distribution of electronic components. Line cards we deal with include Microchip,ALPS,ROHM,Xilinx,Pulse,ON,Everlight and Freescale. Main products comprise IC,Modules,Potentiometer,IC Socket,Relay,Connector.Our parts cover such applications as commercial,industrial, and automotives areas.

We are looking forward to setting up business relationship with you and hope to provide you with the best service and solution. Let us make a better world for our industry!



## Contact us

Tel: +86-755-8981 8866 Fax: +86-755-8427 6832

Email & Skype: info@chipsmall.com Web: www.chipsmall.com

Address: A1208, Overseas Decoration Building, #122 Zhenhua RD., Futian, Shenzhen, China





# FHP3350, FHP3450 Triple and Quad Voltage Feedback Amplifiers

## Features

- 0.1dB gain flatness to 30MHz
- 0.07%/0.03° differential gain/phase error
- 210MHz full power -3dB bandwidth at G = 2
- 1,100V/μs slew rate
- ±55mA output current (drives dual video load)
- ±83mA output short-circuit current
- Output swings to within 1.3V of either rail
- 3.6mA supply current per amplifier
- Minimum stable gain of 3dB or 1.5V/V
- FHP3350 - improved replacement for RC6333
- FHP3450 - improved replacement for RC6334
- Fully specified at +5V, and ±5V supplies

## Applications

- Video driver
- RGB driver
- ADC buffer
- S-video amp
- Active filters

## Description

The FHP3350 and FHP3450 are low-cost, high-performance, voltage-feedback amplifiers designed for video applications. These triple and quad amplifiers consume only 3.6mA of supply current per channel and are capable of driving dual (75Ω) video loads while providing 0.1dB of gain flatness to 30MHz. Consumer video applications also benefit from the low 0.07% differential gain and 0.03° differential phase errors. The FHP3350 offers three outputs that can be put into a high-impedance disable state to allow for video multiplexing or minimize power consumption.

These amplifiers are designed to operate from 5V (±2.5V) to 12V (±6V) supplies. The outputs swing to within 1.3V of either supply rail to accommodate video signals on a single 5V supply.

The FHP3350 and FHP3450 are designed on a complementary bipolar process. They provide 210MHz of full-power bandwidth and 1,100V/μs of slew rate at a supply voltage of ±5V. The combination of high performance, low power, and excellent video performance make these amplifiers well suited for use in many digital consumer video appliances as well as many general-purpose, high-speed applications.

## Typical Application – Driving Dual Video Loads

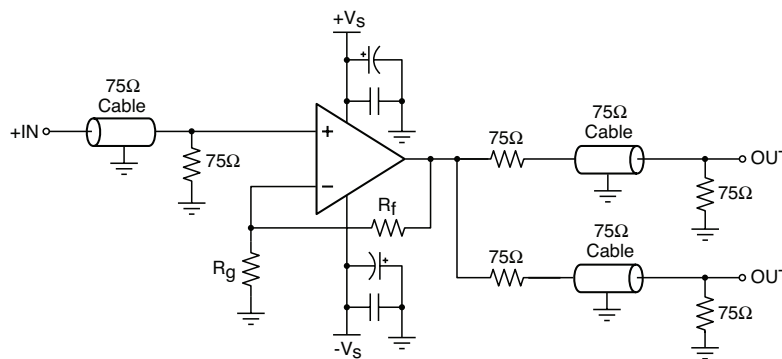

## Ordering Information

Part Number	Package	Lead Free	Operating Temp Range	Packaging Method
FHP3350IMTC14X	TSSOP-14	Yes	-40°C to +85°C	Reel
FHP3350IM14X	SOIC-14	Yes	-40°C to +85°C	Reel
FHP3450IMTC14X	TSSOP-14	Yes	-40°C to +85°C	Reel
FHP3450IM14X	SOIC-14	Yes	-40°C to +85°C	Reel

Moisture sensitivity level for all parts is MSL-1.

### FHP3350 Pin Configurations

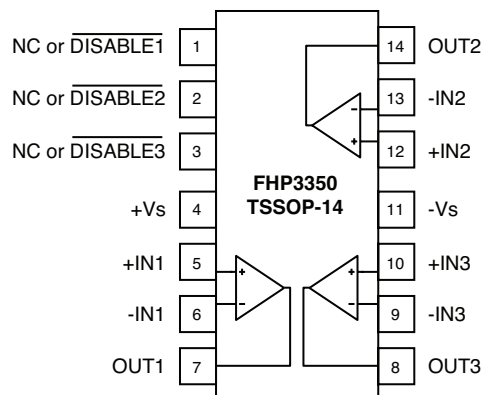

### FHP3350 Pin Assignments

Pin#	Pin	Description
1	NC or DISABLE1	Channel 1 ENABLED if pin is left open or pulled above $V_{ON}$ , DISABLED if pin is grounded or pulled below $V_{OFF}$
2	NC or DISABLE2	Channel 2 ENABLED if pin is left open or pulled above $V_{ON}$ , DISABLED if pin is grounded or pulled below $V_{OFF}$
3	NC or DISABLE3	Channel 3 ENABLED if pin is left open or pulled above $V_{ON}$ , DISABLED if pin is grounded or pulled below $V_{OFF}$
4	+Vs	Positive supply
5	+IN1	Positive Input, channel 1
6	-IN1	Negative Input, channel 1
7	OUT1	Output, channel 1
8	OUT3	Output, channel 3
9	-IN3	Negative Input, channel 3
10	+IN3	Positive Input, channel 3
11	-Vs	Negative supply
12	+IN2	Positive Input, channel 2
13	-IN2	Negative Input, channel 2
14	OUT2	Output, channel 2

### FHP3450 Pin Configurations

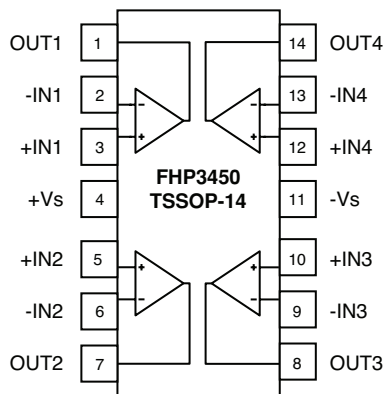

### FHP3450 Pin Assignments

Pin#	Pin	Description
1	OUT1	Output, channel 1
2	-IN1	Negative Input, channel 1
3	+IN1	Positive Input, channel 1
4	+Vs	Positive supply
5	+IN2	Positive Input, channel 2
6	-IN2	Negative Input, channel 2
7	OUT2	Output, channel 2
8	OUT3	Output, channel 3
9	-IN3	Negative Input, channel 3
10	+IN3	Positive Input, channel 3
11	-Vs	Negative supply
12	+IN4	Positive Input, channel 4
13	-IN4	Negative Input, channel 4
14	OUT4	Output, channel 4



## Absolute Maximum Ratings

The “Absolute Maximum Ratings” are those values beyond which the safety of the device cannot be guaranteed. The device should not be operated at these limits. The parametric values defined in the Electrical Characteristics tables are not guaranteed at the absolute maximum ratings. The “Recommended Operating Conditions” table defines the conditions for actual device operation.

Parameter	Min.	Max.	Unit
Supply Voltage	0	12.6	V
Input Voltage Range	$-V_s - 0.5V$	$+V_s + 0.5V$	V

## Reliability Information

Parameter	Min.	Typ.	Max.	Unit
Junction Temperature			150	°C
Storage Temperature Range	-65		150	°C
Lead Temperature (Soldering, 10s)			300	°C
14-Lead TSSOP <sup>1</sup>		160		°C/W
14-Lead SOIC <sup>1</sup>		148		°C/W

### Note:

- Package thermal resistance ( $\theta_{JA}$ ), JEDEC standard, multi-layer test boards, still air.  
Assumed power is concentrated in one channel,  $\theta_{JA}$  is lower if power is distributed in all channels.

## ESD Protection

ESD Protection	FHP3350		FHP3450	
	SOIC	TSSOP	SOIC	TSSOP
Package	SOIC	TSSOP	SOIC	TSSOP
Human Body Model (HBM)	2kV	2kV	2kV	2kV
Charged Device Model (CDM)	2kV	2kV	2kV	1.5kV
Machine Model (MM)	250V	250V	TBD	TBD

## Recommended Operating Conditions

Parameter	Min.	Typ.	Max.	Unit
Operating Temperature Range	-40		+85	°C
Supply Voltage Range	3		12	V

**Electrical Characteristics at +5V**

$T_A = 25^\circ\text{C}$ ,  $V_S = 5\text{V}$ ,  $R_f = 249\Omega$ ,  $R_L = 150\Omega$  to  $V_S/2$ ,  $G = 2$ ; unless otherwise noted.

Symbol	Parameter	Conditions	Min.	Typ.	Max.	Units
<b>Frequency Domain Response</b>						
$BW_{ss}$	-3dB Bandwidth	No Peaking, $G = +2$ , $V_{OUT} = 0.2V_{pp}$		190		MHz
$BW_{Ls}$	Full-Power Bandwidth	No Peaking, $G = +2$ , $V_{OUT} = 2V_{pp}$		190		MHz
$BW_{0.1dB}$	0.1dB Gain Flatness - Large Signal	$G = +2$ , $V_{OUT} = 2V_{pp}$		35		MHz
<b>Time Domain Response</b>						
$t_R, t_F$	Rise and Fall Time	$V_{OUT} = 0.2V$ step		2.0		ns
$t_S$	Settling Time to 0.1%	$V_{OUT} = 2V$ step		20		ns
OS	Overshoot	$V_{OUT} = 0.2V$ step		2.5		%
SR	Slew Rate	2V step. $G = -1$		800		V/ $\mu\text{s}$
<b>Distortion/Noise Response</b>						
HD2	2nd Harmonic Distortion	$V_{OUT} = 2V_{pp}$ , 5MHz		-70		dBc
HD3	3rd Harmonic Distortion	$V_{OUT} = 2V_{pp}$ , 5MHz		-80		dBc
THD	Total Harmonic Distortion	$V_{OUT} = 2V_{pp}$ , 5MHz		-69		dB
DG	Differential Gain	NTSC (3.58MHz); AC coupled		0.08		%
DP	Differential Phase	NTSC (3.58MHz); AC coupled		0.02		$^\circ$
$e_n$	Input Voltage Noise	> 100kHz		8.5		nV/Hz
$i_n$	Input Current Noise	> 100kHz		1		pA/Hz
$X_{TALK}$	Crosstalk	at 5MHz		-70		dB
<b>DC Performance</b>						
$V_{IO}$	Input Offset Voltage			1		mV
$dV_{IO}$	Average Drift			10		$\mu\text{V}/^\circ\text{C}$
$I_{bn}$	Input Bias Current			$\pm 50$		nA
$dI_{bn}$	Average Drift			0.33		nA/ $^\circ\text{C}$
$I_{IO}$	Input Offset Current			$\pm 50$		nA
PSRR	Power Supply Rejection Ratio	DC		75		dB
$A_{OL}$	Open Loop Gain	DC		55		dB
$I_S$	Supply Current per Amplifier			3.0		mA
$I_{SD}$	Disable Supply Current per Amp	Disable Mode		35		$\mu\text{A}$
<b>Disable Characteristics</b>						
$OFF_{ISO}$	Off Isolation	5MHz		-60		dB
$OFFC_{OUT}$	Off Output Capacitance			3		pF
$CH_{ISO}$	Channel-to-Channel Isolation	5MHz		-85		dB
$T_{ON}$	Turn-On Time			300		ns
$T_{OFF}$	Turn-Off Time			80		ns
$V_{OFF}$	Power Down Input Voltage	DISABLE pins; disabled if pin is grounded or pulled below $V_{OFF}$			$+V_S - 3.1$	V
$V_{ON}$	Enable Input Voltage	DISABLE pins; enabled if pin is left open or pulled above $V_{ON}$	$+V_S - 1.9$			V

**Electrical Characteristics at +5V (Continued)**

$T_A = 25^\circ\text{C}$ ,  $V_S = 5\text{V}$ ,  $R_f = 249\Omega$ ,  $R_L = 150\Omega$  to  $V_S/2$ ,  $G = 2$ ; unless otherwise noted.

Symbol	Parameter	Conditions	Min.	Typ.	Max.	Units
<b>Input Characteristics</b>						
$R_{IN}$	Input Resistance			70		$M\Omega$
$C_{IN}$	Input Capacitance			1		pF
CMIR	Input Common Mode Voltage Range			1.2 to 3.8		V
CMRR	Common Mode Rejection Ratio	DC, $V_{CM} = 1.5\text{V}$ to $3.5\text{V}$		90		dB
<b>Output Characteristics</b>						
$V_O$	Output Voltage Swing	$R_L = 2k\Omega$ to $V_S/2$		1 to 4		V
		$R_L = 150\Omega$ to $V_S/2$		1.1 to 3.9		V
$I_{OUT}$	Linear Output Current	$V_O = +V_S/2$		$\pm 50$		mA
$I_{SC}$	Short-Circuit Output Current	$V_O =$ shorted to $+V_S$ or GND		$\pm 75$		mA

**Electrical Characteristics at  $\pm 5V$** 

$T_A = 25^\circ\text{C}$ ,  $V_S = \pm 5V$ ,  $R_f = 249\Omega$ ,  $R_L = 150\Omega$  to GND,  $G = 2$ ; unless otherwise noted.

Symbol	Parameter	Conditions	Min.	Typ.	Max.	Units
<b>Frequency Domain Response</b>						
$BW_{ss}$	-3dB Bandwidth	No Peaking, $G = +2$ , $V_{OUT} = 0.2V_{pp}$		210		MHz
$BW_{Ls}$	Full-Power Bandwidth	No Peaking, $G = +2$ , $V_{OUT} = 2V_{pp}$		210		MHz
$BW_{0.1dB}$	0.1dB Gain Flatness - Large Signal	$G = +2$ , $V_{OUT} = 2V_{pp}$		30		MHz
$BW_{0.1dBss}$	0.1dB Gain Flatness - Small Signal	$G = +2$ , $V_{OUT} = 0.2V_{pp}$		50		MHz
<b>Time Domain Response</b>						
$t_R, t_F$	Rise and Fall Time	$V_{OUT} = 0.2V$ step		2		ns
$t_S$	Settling Time to 0.1%	$V_{OUT} = 2V$ step		20		ns
OS	Overshoot	$V_{OUT} = 0.2V$ step		1		%
SR	Slew Rate	2V step. $G = -1$		1100		V/ $\mu$ s
<b>Distortion / Noise Response</b>						
HD2	2nd Harmonic Distortion	$V_{OUT} = 2V_{pp}$ , 5MHz		-70		dBc
HD3	3rd Harmonic Distortion	$V_{OUT} = 2V_{pp}$ , 5MHz		-74		dBc
THD	Total Harmonic Distortion	$V_{OUT} = 2V_{pp}$ , 5MHz		-68		dB
DG	Differential Gain	NTSC (3.58MHz); AC coupled		0.07		%
DP	Differenital Phase	NTSC (3.58MHz); AC coupled		0.03		$^\circ$
$e_n$	Input Voltage Noise	> 100kHz		9		nV/Hz
$i_n$	Input Current Noise	> 100kHz		1		pA/Hz
$X_{TALK}$	Crosstalk	at 5MHz		-71		dB
<b>DC Performance</b>						
$V_{IO}$	Input Offset Voltage <sup>1</sup>		-7	1	7	mV
$dV_{IO}$	Average Drift			15		$\mu$ V/ $^\circ$ C
$I_{bn}$	Input Bias Current <sup>1</sup>		-500	$\pm 100$	500	nA
$dI_{bn}$	Average Drift			0.3		nA/ $^\circ$ C
$I_{IO}$	Input Offset Current <sup>1</sup>		-500	$\pm 50$	500	nA
PSRR	Power Supply Rejection Ratio <sup>1</sup>	DC	58	75		dB
$A_{OL}$	Open Loop Gain <sup>1</sup>	DC	52	58		dB
$I_S$	Supply Current per Amplifier <sup>1</sup>			3.6	5	mA
$I_{SD}$	Disable Supply Current per Amp <sup>1</sup>	Disable Mode		45	100	$\mu$ A
<b>Disable Characteristics</b>						
$OFF_{ISO}$	Off Isolation	5MHz		-65		dB
$OFFC_{OUT}$	Off Output Capacitance			3		pF
$CH_{ISO}$	Channel-to-Channel Isolation	5MHz		-85		dB
$T_{ON}$	Turn-On Time			300		ns
$T_{OFF}$	Turn-Off Time			80		ns
$V_{OFF}$	Power Down Input Voltage	DISABLE pins; disabled if pin is grounded or pulled below $V_{OFF}$			$+V_S - 3.1$	V
$V_{ON}$	Enable Input Voltage	DISABLE pins; enabled if pin is left open or pulled above $V_{ON}$	$+V_S - 1.9$			V

**Notes:**

1. 100% tested at  $25^\circ\text{C}$

**Electrical Characteristics at  $\pm 5V$  (Continued)**

$T_A = 25^\circ\text{C}$ ,  $V_S = \pm 5V$ ,  $R_f = 249\Omega$ ,  $R_L = 150\Omega$  to GND,  $G = 2$ ; unless otherwise noted.

Symbol	Parameter	Conditions	Min	Typ	Max	Units
<b>Input Characteristics</b>						
$R_{IN}$	Input Resistance			70		$M\Omega$
$C_{IN}$	Input Capacitance			0.6		pF
CMIR	Input Common Mode Voltage Range			-3.8 to 3.8		V
CMRR	Common Mode Rejection Ratio <sup>1</sup>	DC, $V_{CM} = -3.5V$ to $3.5V$	58	98		dB
<b>Output Characteristics</b>						
$V_O$	Output Voltage Swing	$R_L = 2k\Omega$		$\pm 4$		V
		$R_L = 150\Omega$ <sup>1</sup>	$\pm 3.2$	$\pm 3.7$		V
$I_{OUT}$	Linear Output Current	$V_O = 0V$		$\pm 55$		mA
$I_{SC}$	Short-Circuit Output Current	$V_O$ shorted to GND		$\pm 83$		mA

**Notes:**

1. 100% tested at  $25^\circ\text{C}$



### Typical Performance Characteristics

$T_A = 25^\circ\text{C}$ ,  $V_S = 5\text{V}$ ,  $R_f = 249\Omega$ ,  $R_L = 150\Omega$  to  $V_S/2$ ,  $G = 2$ ; unless otherwise noted.

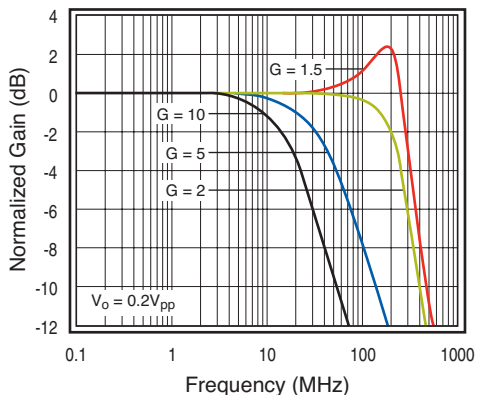

Figure 1. Non-Inverting Freq. Response ( $\pm 5\text{V}$ )

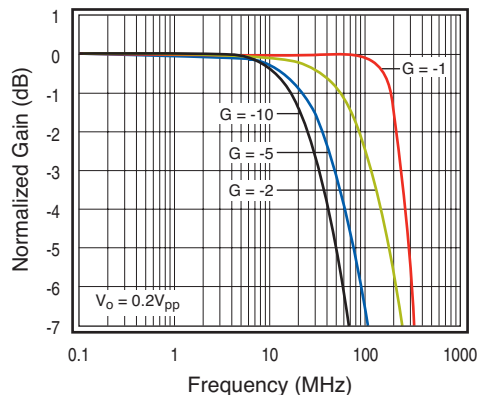

Figure 2. Inverting Freq. Response ( $\pm 5\text{V}$ )

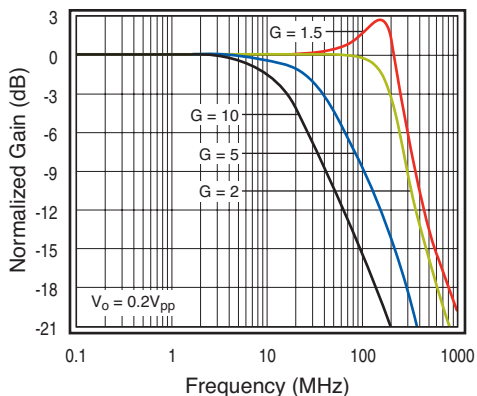

Figure 3. Non-Inverting Freq. Response (+5V)

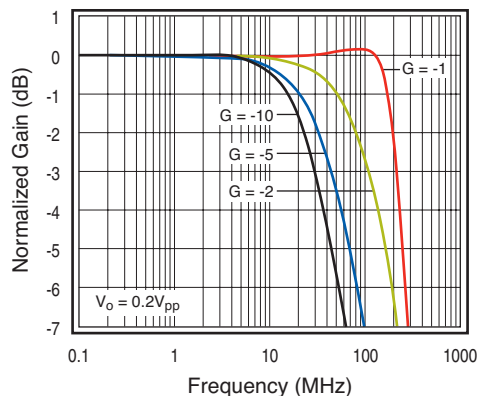

Figure 4. Inverting Freq. Response (+5V)

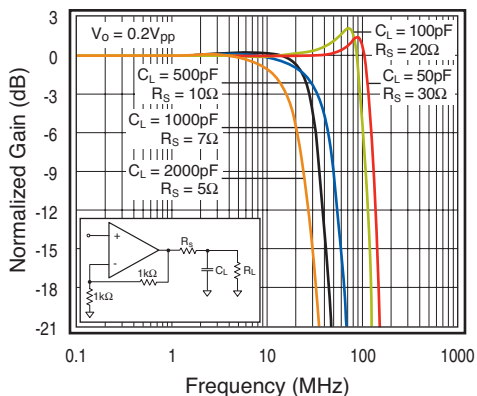

Figure 5. Frequency Response vs.  $C_L$  (+5V)

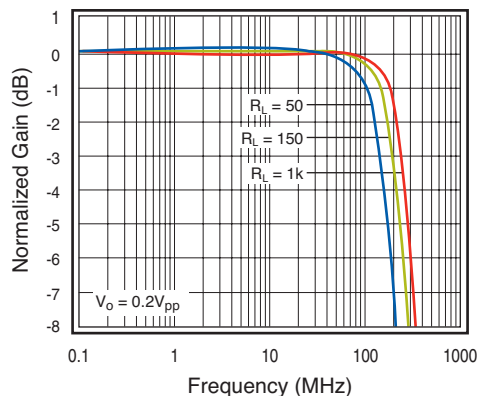

Figure 6. Frequency Response vs.  $R_L$  (+5V)

### Typical Performance Characteristics

$T_A = 25^\circ\text{C}$ ,  $V_S = 5\text{V}$ ,  $R_f = 249\Omega$ ,  $R_L = 150\Omega$  to  $V_S/2$ ,  $G = 2$ ; unless otherwise noted.

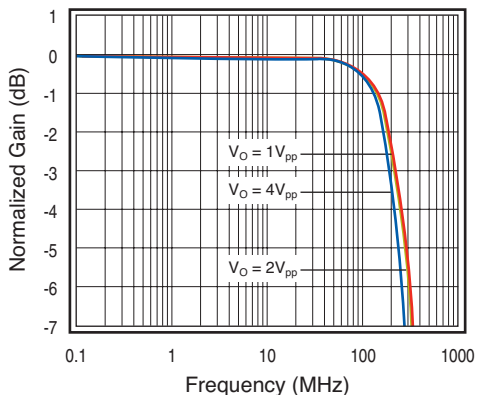

Figure 7. Large Signal Freq. Response ( $\pm 5\text{V}$ )

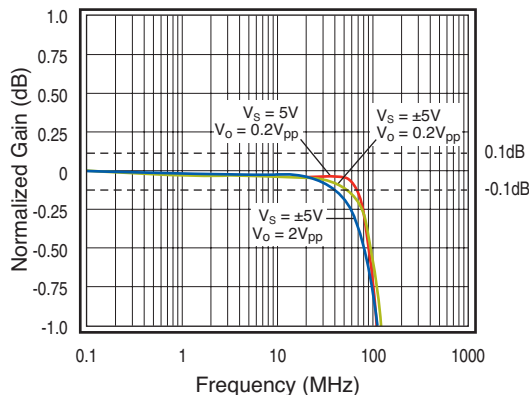

Figure 8. Gain Flatness vs. Frequency

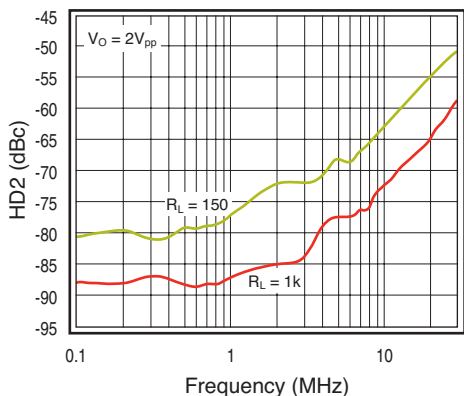

Figure 9. HD2 vs. Frequency ( $\pm 5\text{V}$ )

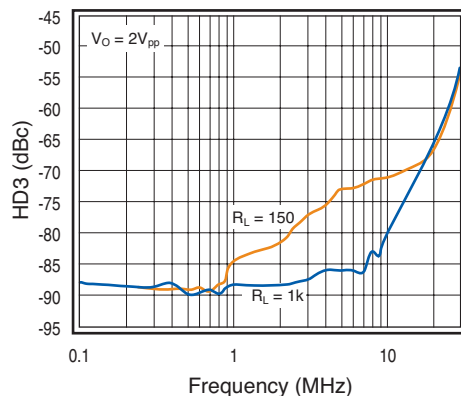

Figure 10. HD3 vs. Frequency ( $\pm 5\text{V}$ )

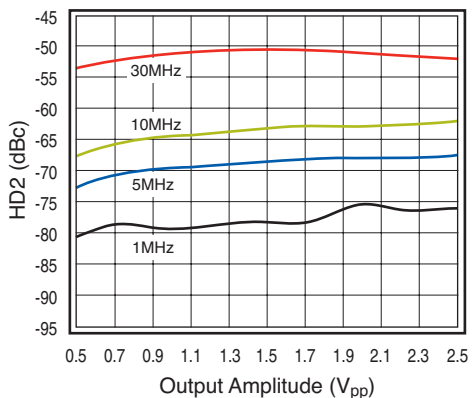

Figure 11. HD2 vs.  $V_o$  ( $\pm 5\text{V}$ )

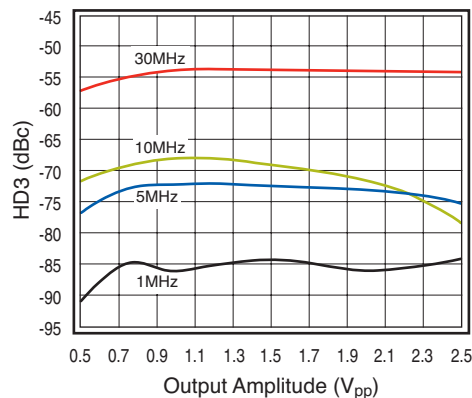

Figure 12. HD3 vs.  $V_o$  ( $\pm 5\text{V}$ )

### Typical Performance Characteristics

$T_A = 25^\circ\text{C}$ ,  $V_S = 5\text{V}$ ,  $R_f = 249\Omega$ ,  $R_L = 150\Omega$  to  $V_S/2$ ,  $G = 2$ ; unless otherwise noted.

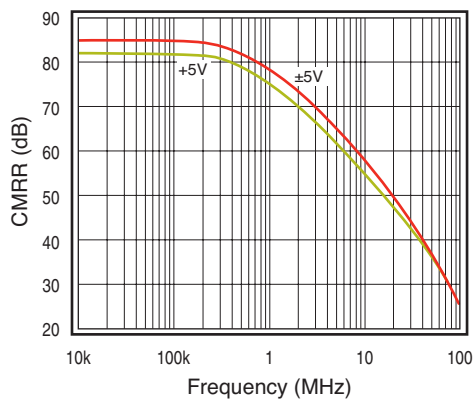

Figure 13. CMRR vs. Frequency

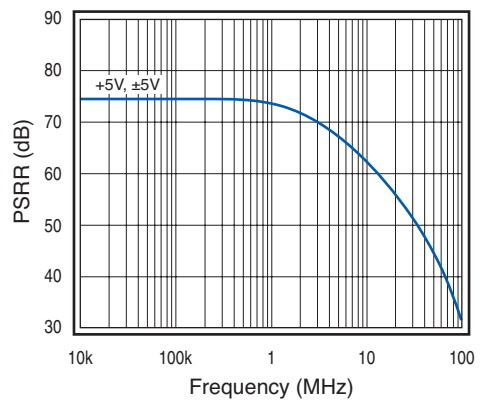

Figure 14. PSRR vs. Frequency

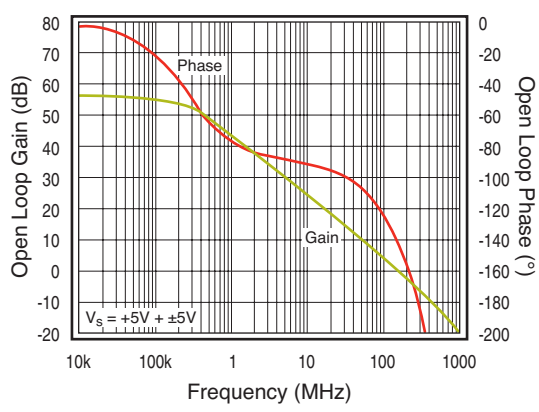

Figure 15. Open Loop Gain & Phase vs. Freq.

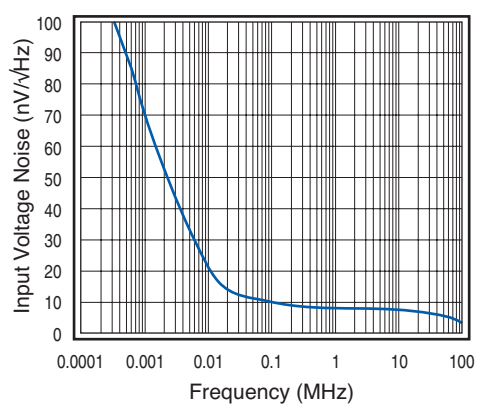

Figure 16. Input Voltage Noise (+5V)

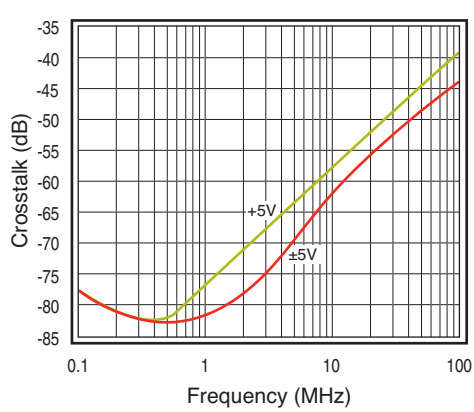

Figure 17. Crosstalk vs. Frequency (+5V)

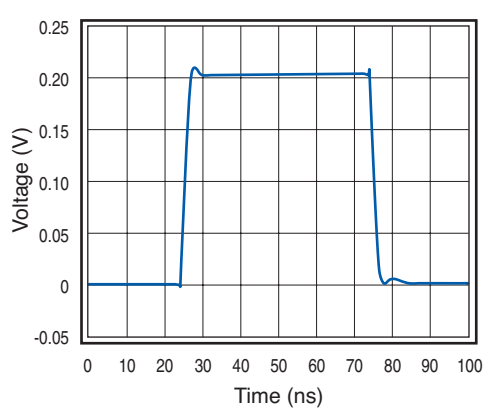

Figure 18. Small Signal Pulse Response (+5V)

### Typical Performance Characteristics

$T_A = 25^\circ\text{C}$ ,  $V_S = 5\text{V}$ ,  $R_f = 249\Omega$ ,  $R_L = 150\Omega$  to  $V_S/2$ ,  $G = 2$ ; unless otherwise noted.

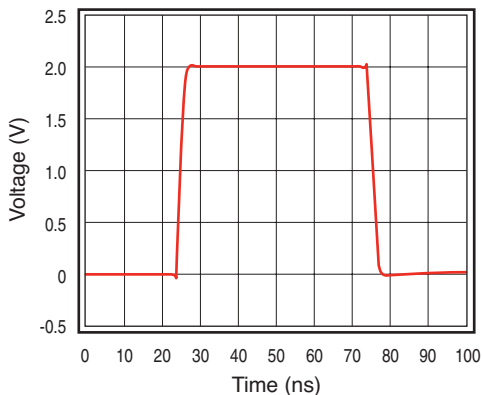

Figure 19. Large Signal Pulse Response (+5V)

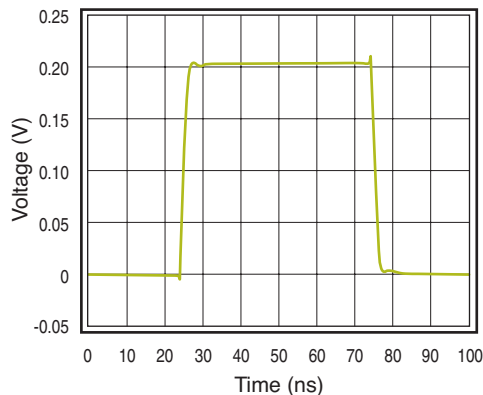

Figure 20. Small Signal Pulse Response ( $\pm 5\text{V}$ )

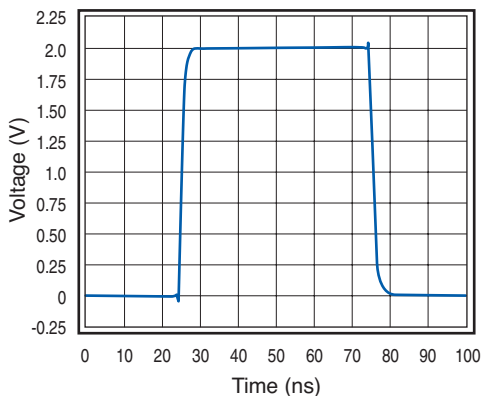

Figure 21. Large Signal Pulse Response ( $\pm 5\text{V}$ )

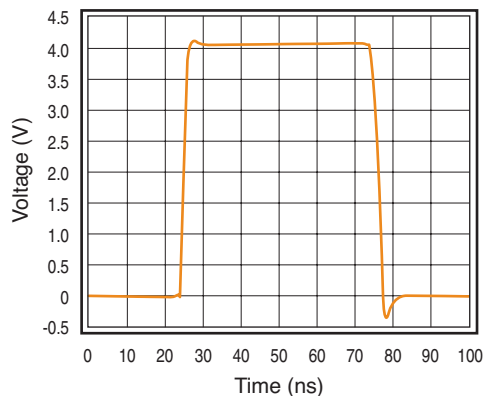

Figure 22. Large Signal Pulse Response ( $\pm 5\text{V}$ )

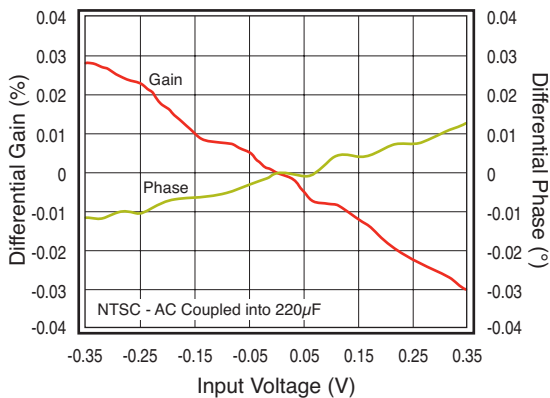

Figure 23. Differential Gain and Phase ( $\pm 2.5\text{V}$ )

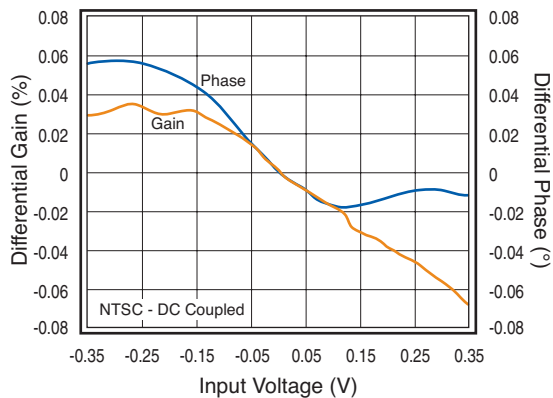

Figure 24. Differential Gain and Phase ( $\pm 2.5\text{V}$ )

### Typical Performance Characteristics

$T_A = 25^\circ\text{C}$ ,  $V_S = 5\text{V}$ ,  $R_f = 249\Omega$ ,  $R_L = 150\Omega$  to  $V_S/2$ ,  $G = 2$ ; unless otherwise noted.

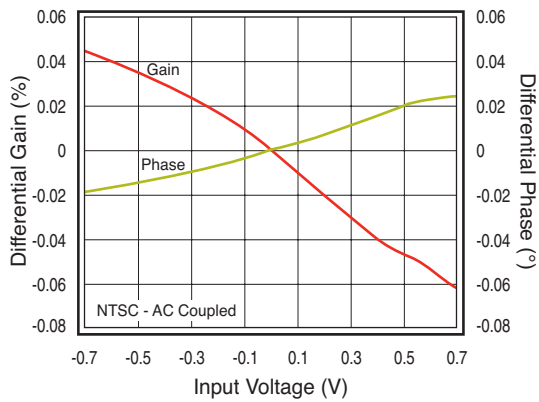

Figure 25. Differential Gain and Phase ( $\pm 5\text{V}$ )

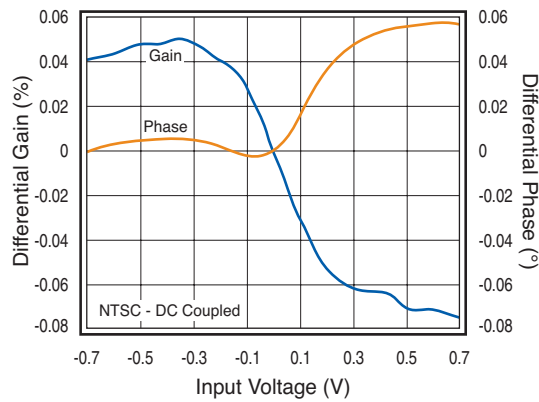

Figure 26. Differential Gain and Phase ( $\pm 5\text{V}$ )

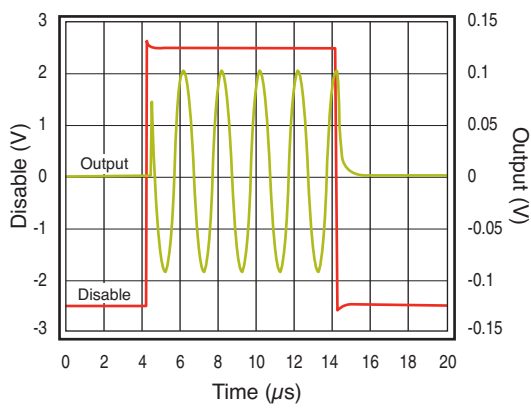

Figure 27. Enable/Disable Response ( $\pm 2.5\text{V}$ )

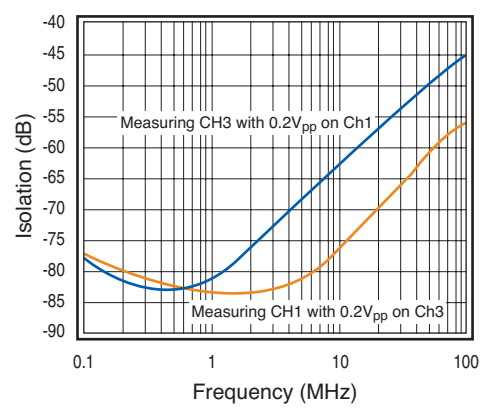

Figure 28. Channel-to-Channel Isolation ( $+5\text{V}$ )

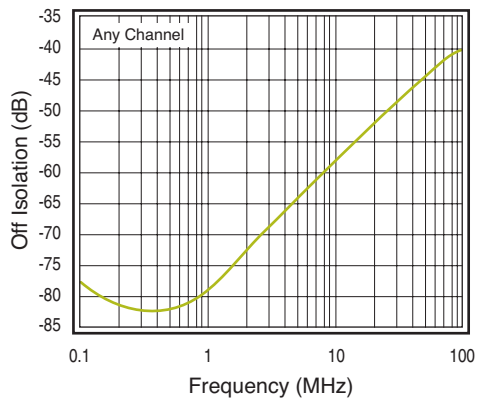

Figure 29. Off Isolation ( $+5\text{V}$ )

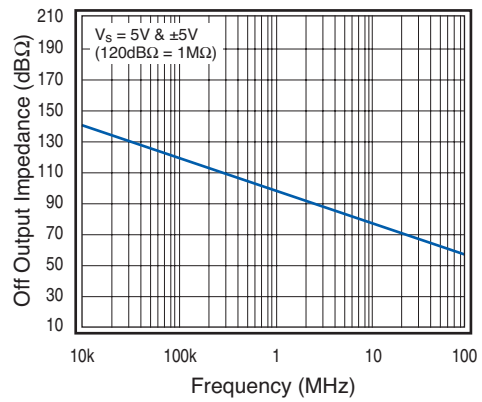

Figure 30. Off Output Impedance ( $+5\text{V}$ )

## Applications Information

### General Description

The FHP3350 and FHP3450 are low-cost, high-performance, voltage feedback amplifiers designed for video applications. These triple and quad amplifiers consume only 3.6mA of supply current per channel and are capable of driving dual (75Ω) video loads while providing 0.1dB of gain flatness to 30MHz. Consumer video applications also benefit from the low 0.07% differential gain and 0.03° differential phase errors. The FHP3350 offers three outputs that can be put into a high-impedance disable state to allow for video multiplexing or minimize power consumption.

These amplifiers are designed to operate from 5V (±2.5V) to 12V (±6V) supplies. The outputs swing to within 1.3V of either supply rail to accommodate video signals on a single 5V supply.

The FHP3350 and FHP3450 are designed on a complementary bipolar process. They provide 210MHz of full-power bandwidth and 1,100V/μs of slew rate at a supply voltage of ±5V. The combination of high performance, low power, and excellent video performance make these amplifiers well suited for use in many digital consumer video appliances as well as many general-purpose, high-speed applications.

### Driving Capacitive Loads

The Frequency Response vs.  $C_L$  plot on page 8, illustrates the response of the FHP3350 Family. A small series resistance ( $R_s$ ) at the output of the amplifier, illustrated in Figure 1, will improve stability and settling performance.  $R_s$  values in the Frequency Response vs.  $C_L$  plot were chosen to achieve maximum bandwidth with less than 1dB of peaking. For maximum flatness, use a larger  $R_s$ .

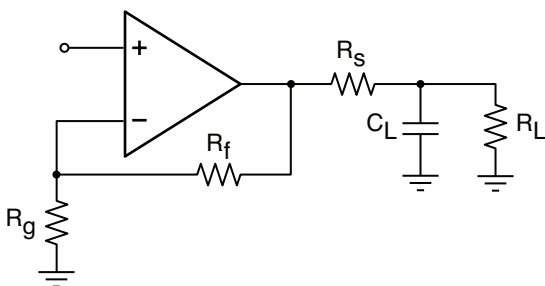

**Figure 31. Typical Topology for Driving Capacitive Loads**

### Power Dissipation

The maximum internal power dissipation allowed is directly related to the maximum junction temperature. If the maximum junction temperature exceeds 150°C for an extended time, device failure may occur. The FHP3350 and FHP3450 are short circuit protected. However, this may not guarantee that the maximum junction temperature (+150°C) is not exceeded under all conditions. RMS Power Dissipation can be calculated using the following equation:

$$\text{Power Dissipation} = I_s * (V_s+ - V_s-) + (V_s+ - V_{o(RMS)}) * I_{OUT(RMS)}$$

Where  $I_s$  is the supply current,  $V_s+$  is the positive supply pin voltage,  $V_s-$  is the negative supply pin voltage,  $V_{o(RMS)}$  is the RMS output voltage and  $I_{OUT(RMS)}$  is the RMS output current delivered to the load. Follow the maximum power derating curves shown in Figure 32 below to ensure proper operation.

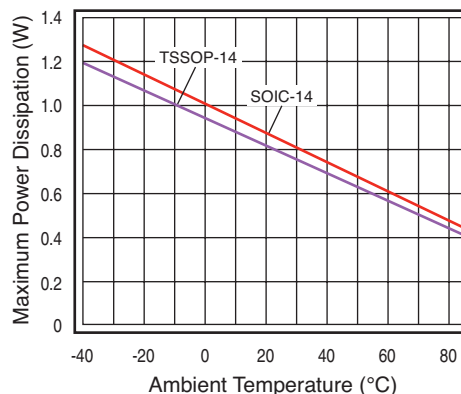

**Figure 32. Maximum Power Derating**

### Overdrive Recovery

For an amplifier, an overdrive condition occurs when the output and/or input ranges are exceeded. The recovery time varies based on whether the input or output is overdriven and by how much the ranges are exceeded. The FHP3350/3450 will typically recover in less than 50ns from an overdrive condition. Figure 33 shows the FHP3350 in an overdriven condition.

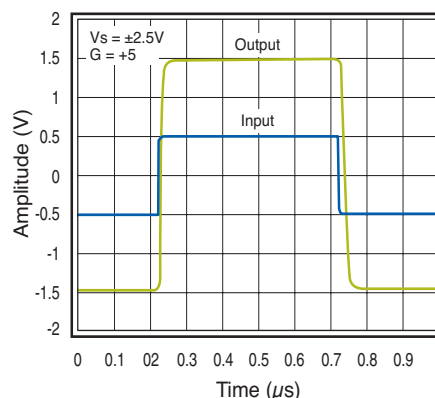

**Figure 33. Overdrive Recovery**



### Layout Considerations

General layout and supply bypassing play major roles in high frequency performance. Fairchild has evaluation boards to use as a guide for high frequency layout and as aid in device testing and characterization. Follow the steps below as a basis for high frequency layout:

- Include 6.8 $\mu$ F and 0.01 $\mu$ F ceramic capacitors
- Place the 6.8 $\mu$ F capacitor within 0.75 inches of the power pin
- Place the 0.01 $\mu$ F capacitor within 0.1 inches of the power pin
- Remove the ground plane under and around the part, especially near the input and output pins to reduce parasitic capacitance
- Minimize all trace lengths to reduce series inductances

Refer to the evaluation board layouts below for more information.

### Evaluation Board Information

The following evaluation boards are available to aid in the testing and layout of these devices:

Evaluation Board #	Products
KEB019	FHP3350IM14X
KEB020	FHP3350IMTC14X
KEB012	FHP3450IMTC14X
KEB018	FHP3450IM14X

### Evaluation Board Schematics

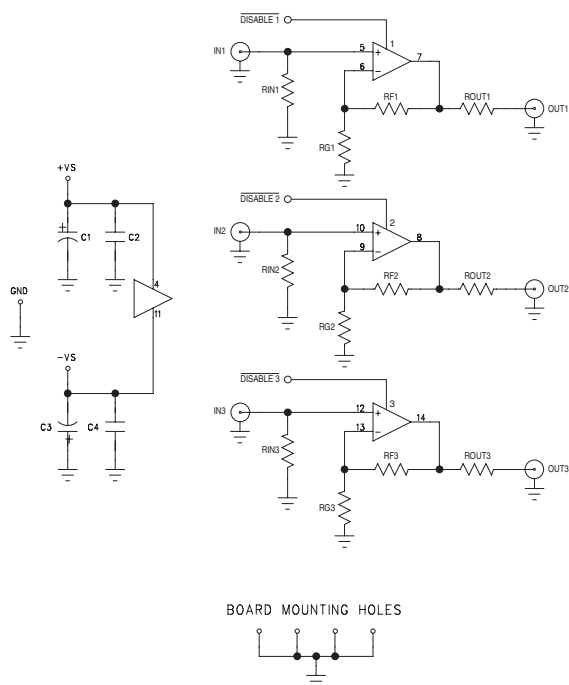

Figure 34. FHP3350 KEB019/KEB020 Schematic

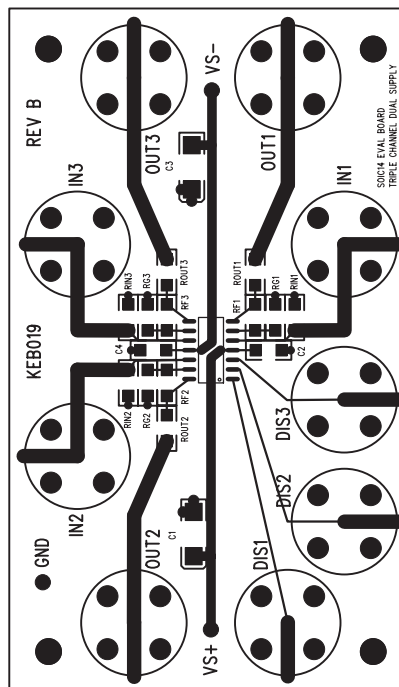

Figure 35. FHP3350 KEB019 (Top Side)

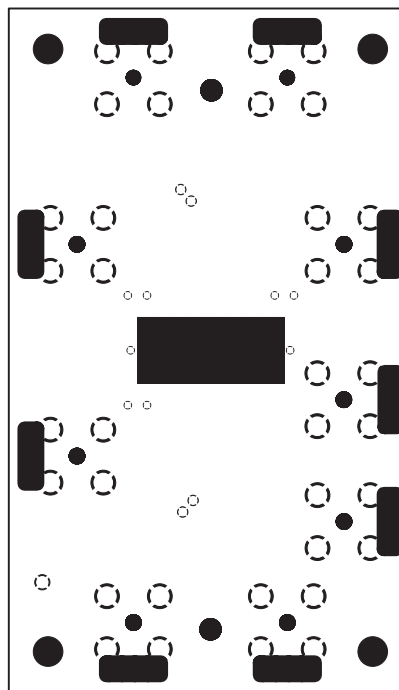

Figure 36. FHP3350 KEB019 (Bottom Side)

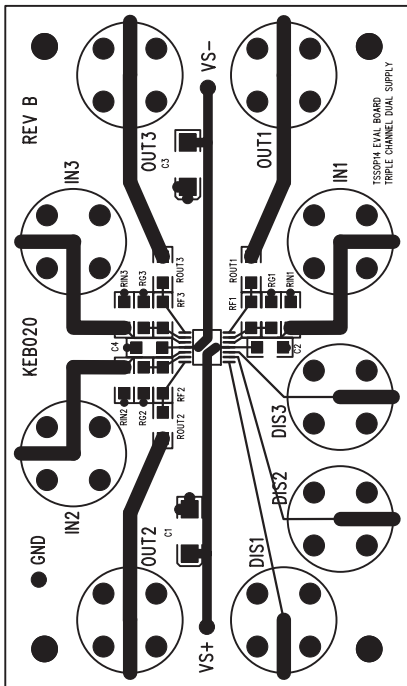

Figure 37. FHP3350 KEB020 (Top Side)

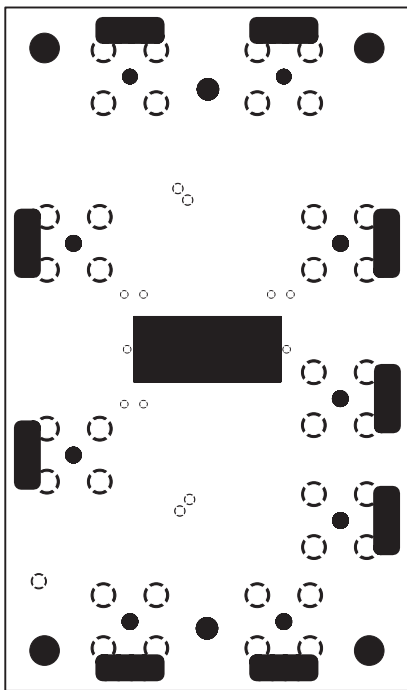

Figure 38. FHP3350 KEB020 (Bottom Side)

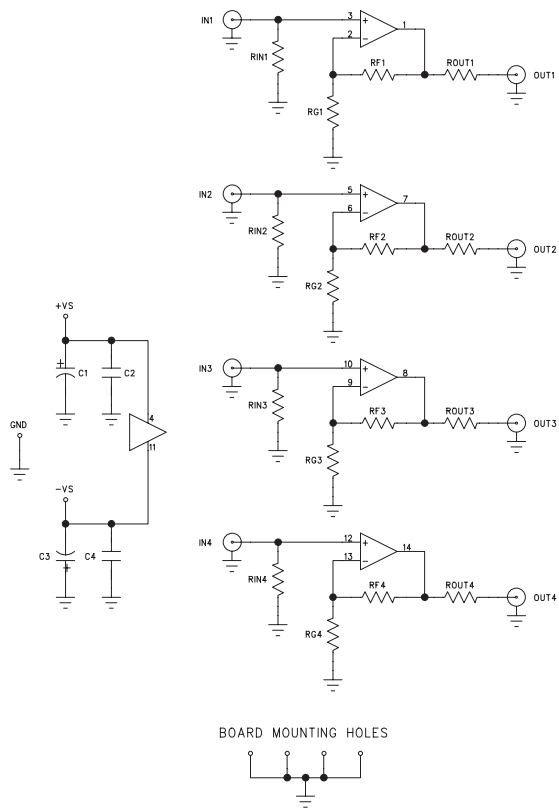

Figure 39. FHP3450 KEB012/KEB018 Schematic

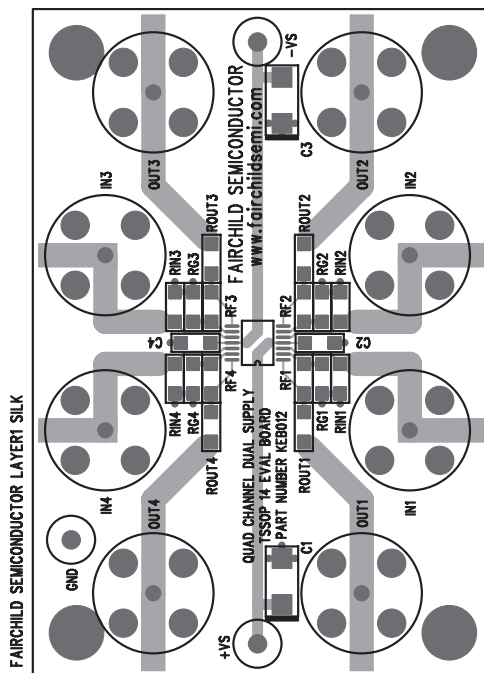

Figure 40. FHP3450 KEB012 (Top Side)

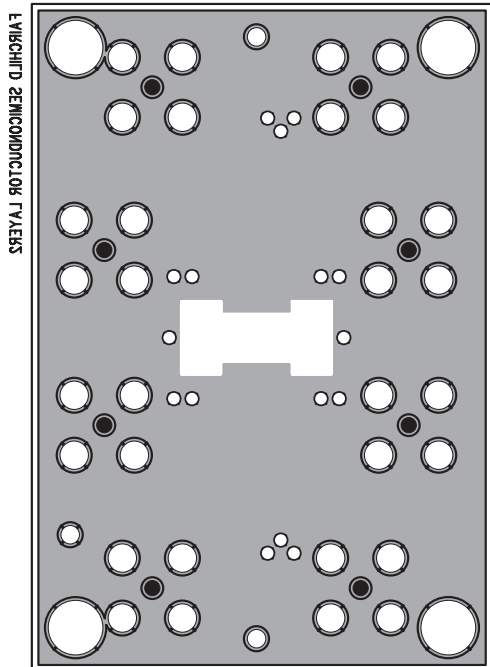

Figure 41. FHP3450 KEB012 (Bottom Side)

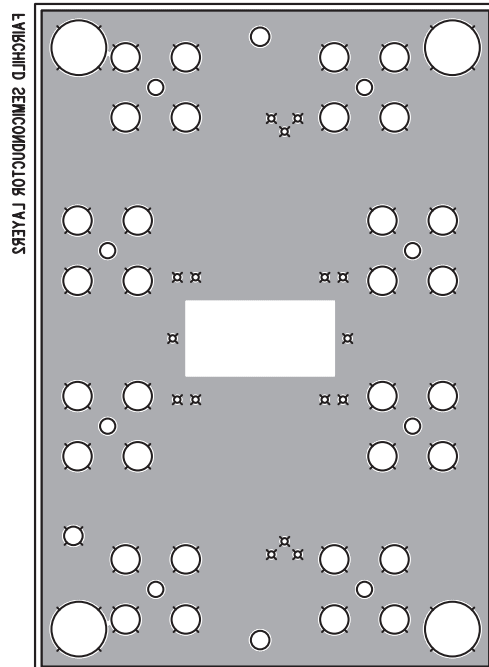

Figure 43. FHP3450 KEB018 (Bottom Side)

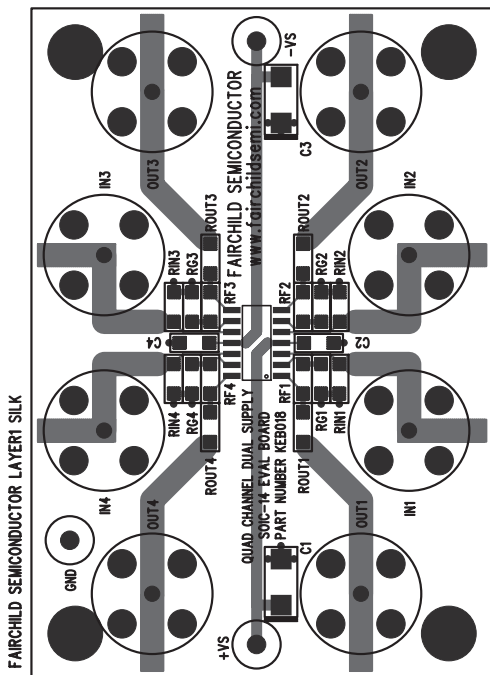
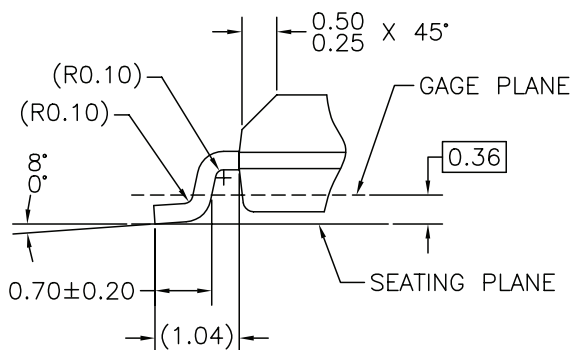
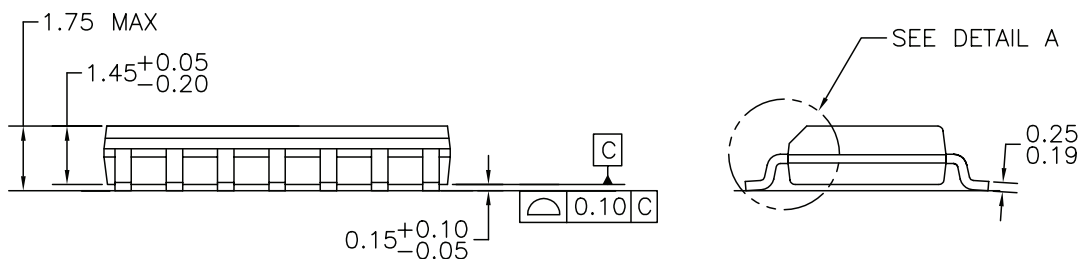
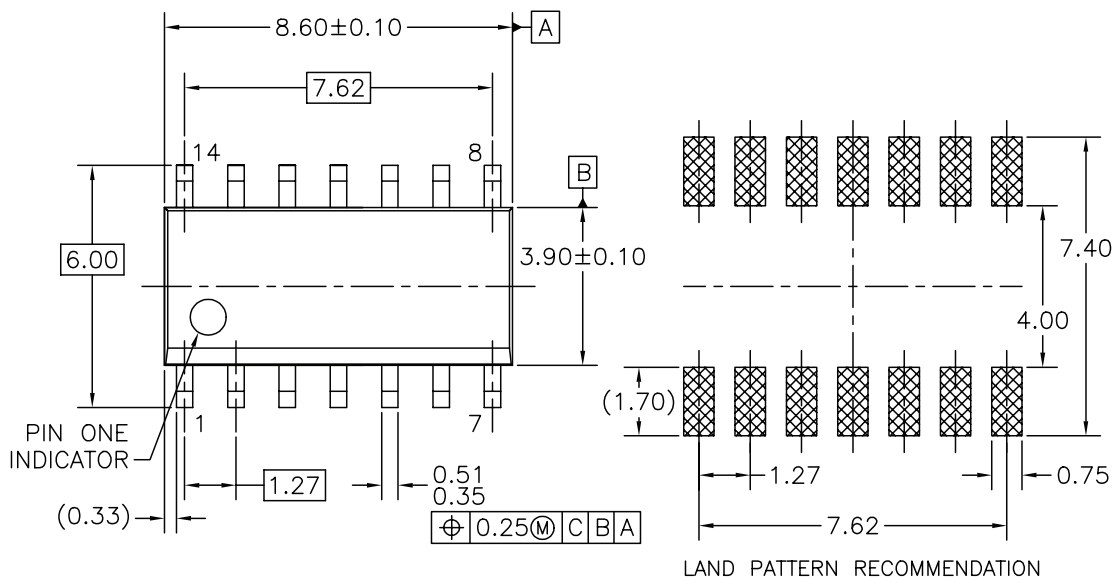

Figure 42. FHP3450 KEB018 (Top Side)



## Mechanical Dimensions

14-Lead Small Outline Package (SOIC)  
Number M14A RevL



NOTES: UNLESS OTHERWISE SPECIFIED

- A) THIS PACKAGE CONFORMS TO JEDEC MS-012, VARIATION AB, ISSUE C, DATED MAY 1990.
- B) ALL DIMENSIONS ARE IN MILLIMETERS.
- C) DIMENSIONS DO NOT INCLUDE MOLD FLASH OR BURRS.

M14AREVL

DETAIL A  
SCALE: 20:1

## TRADEMARKS

The following are registered and unregistered trademarks Fairchild Semiconductor owns or is authorized to use and is not intended to be an exhaustive list of all such trademarks.

ACEx™	FACT Quiet Series™	OCX™	SILENT SWITCHER®	UniFET™
ActiveArray™	GlobalOptoisolator™	OCXPro™	SMART START™	VCX™
Bottomless™	GTO™	OPTOLOGIC®	SPM™	Wire™
Build it Now™	HiSeC™	OPTOPLANAR™	Stealth™	
CoolFET™	I <sup>2</sup> C™	PACMAN™	SuperFET™	
CROSSVOLT™	i-Lo™	POP™	SuperSOT™-3	
DOME™	ImpliedDisconnect™	Power247™	SuperSOT™-6	
EcoSPARK™	IntelliMAX™	PowerEdge™	SuperSOT™-8	
E <sup>2</sup> C MOS™	ISOPLANAR™	PowerSaver™	SyncFET™	
EnSigna™	LittleFET™	PowerTrench®	TCM™	
FACT®	MICROCOUPLER™	QFET®	TinyBoost™	
FAST®	MicroFET™	QS™	TinyBuck™	
FASTr™	MicroPak™	QT Optoelectronics™	TinyPWM™	
FPS™	MICROWIRE™	Quiet Series™	TinyPower™	
FRFET™	MSX™	RapidConfigure™	TinyLogic®	
	MSXPro™	RapidConnect™	TINYOPTO™	
Across the board. Around the world.™		µSerDes™	TruTranslation™	
The Power Franchise®		ScalarPump™	UHC®	
Programmable Active Droop™				

## DISCLAIMER

FAIRCHILD SEMICONDUCTOR RESERVES THE RIGHT TO MAKE CHANGES WITHOUT FURTHER NOTICE TO ANY PRODUCTS HEREIN TO IMPROVE RELIABILITY, FUNCTION, OR DESIGN. FAIRCHILD DOES NOT ASSUME ANY LIABILITY ARISING OUT OF THE APPLICATION OR USE OF ANY PRODUCT OR CIRCUIT DESCRIBED HEREIN; NEITHER DOES IT CONVEY ANY LICENSE UNDER ITS PATENT RIGHTS, NOR THE RIGHTS OF OTHERS. THESE SPECIFICATIONS DO NOT EXPAND THE TERMS OF FAIRCHILD'S WORLDWIDE TERMS AND CONDITIONS, SPECIFICALLY THE WARRANTY THEREIN, WHICH COVERS THESE PRODUCTS.

## LIFE SUPPORT POLICY

FAIRCHILD'S PRODUCTS ARE NOT AUTHORIZED FOR USE AS CRITICAL COMPONENTS IN LIFE SUPPORT DEVICES OR SYSTEMS WITHOUT THE EXPRESS WRITTEN APPROVAL OF FAIRCHILD SEMICONDUCTOR CORPORATION.

As used herein:

- Life support devices or systems are devices or systems which, (a) are intended for surgical implant into the body, or (b) support or sustain life, or (c) whose failure to perform when properly used in accordance with instructions for use provided in the labeling, can be reasonably expected to result in significant injury to the user.
- A critical component is any component of a life support device or system whose failure to perform can be reasonably expected to cause the failure of the life support device or system, or to affect its safety or effectiveness.

## PRODUCT STATUS DEFINITIONS

### Definition of Terms

Datasheet Identification	Product Status	Definition
Advance Information	Formative or In Design	This datasheet contains the design specifications for product development. Specifications may change in any manner without notice.
Preliminary	First Production	This datasheet contains preliminary data, and supplementary data will be published at a later date. Fairchild Semiconductor reserves the right to make changes at any time without notice to improve design.
No Identification Needed	Full Production	This datasheet contains final specifications. Fairchild Semiconductor reserves the right to make changes at any time without notice to improve design.
Obsolete	Not In Production	This datasheet contains specifications on a product that has been discontinued by Fairchild semiconductor. The datasheet is printed for reference information only.

Rev. I22