



Chipsmall Limited consists of a professional team with an average of over 10 year of expertise in the distribution of electronic components. Based in Hongkong, we have already established firm and mutual-benefit business relationships with customers from,Europe,America and south Asia,supplying obsolete and hard-to-find components to meet their specific needs.

With the principle of “Quality Parts,Customers Priority,Honest Operation,and Considerate Service”,our business mainly focus on the distribution of electronic components. Line cards we deal with include Microchip,ALPS,ROHM,Xilinx,Pulse,ON,Everlight and Freescale. Main products comprise IC,Modules,Potentiometer,IC Socket,Relay,Connector.Our parts cover such applications as commercial,industrial, and automotives areas.

We are looking forward to setting up business relationship with you and hope to provide you with the best service and solution. Let us make a better world for our industry!



Contact us

Tel: +86-755-8981 8866 Fax: +86-755-8427 6832

Email & Skype: info@chipsmall.com Web: www.chipsmall.com

Address: A1208, Overseas Decoration Building, #122 Zhenhua RD., Futian, Shenzhen, China



Minisens

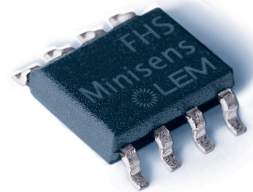

Introduction

The Minisens transducer is an ultra flat SMD open loop integrated circuit current transducer based on the Hall effect principle. It is suitable for the electronic measurement of currents: DC, AC, pulsed, mixed. It has no insertion loss and provides galvanic isolation between the primary circuit (high power) and the secondary circuit (sensor). It measures the magnetic field generated by the current flowing in a conductor such as a PCB track. The output voltage is proportional to that magnetic field.

The IC is calibrated to minimize offset and temperature drifts. An integrated magnetic circuit gives an optimum transducer sensitivity. High isolation between the primary circuit and transducer electronics can be obtained with a double sided PCB.

This datasheet is for a device programmed for maximum sensitivity: other options will be available. For example, the sensitivity range will be adjustable, and a choice of fixed or ratiometric (proportional to power supply voltage) sensitivity and reference voltage will be offered.

Features

- Programmable Hall effect transducer for current measurement applications up to $\pm 100 A$
- 5 V power supply
- Standard S01C 8 pin package
- Magnetic field measurement range $\pm 3.3 mT$
- Sensitivity range up over to 200 mV/A
- Isolated current measurement.

Advantages

- Low cost
- Small size
- Excellent linearity
- No power loss in primary circuit
- Internal or external reference voltage may be used on the same pin
- Standby mode for reduced power consumption
- Additional output for fast detection with response time 3 μs .

Applications

- Battery supplied applications
- Motor control
- Power meter
- Uninterruptible Power Supplies (UPS)
- Switched Mode Power Supplies (SMPS)
- Overcurrent fault protection
- Threshold detection
- Garage door opener
- Window shutters
- Motors and fans
- Air conditioning
- White goods.

Application domain

- Industrial.

Standard

- EN 50178.

Absolute maximum ratings (non operating)

Parameter	Symbol	Unit	Specifications	Conditions
Supply voltage	V_c	V	5.6	Exceeding this voltage may temporarily reconfigure the circuit until next power-on
			8.25	Destructive
Electrostatic discharge		kV	2	Human Body Model
Latch-Up, Normal mode			According to Jedec Standard JESD78A	
Latch-Up, Standby mode			According to Jedec Standard JESD78A	@ 25°C
Latch-Up voltage in Standby mode		V	6.5	@ 125°C
Ambient operating temperature	T_A	°C	- 40 .. + 125	
Ambient storage temperature	T_s	°C	- 55 .. + 150	
Output short circuit duration			Indefinite	

Block diagram

This block diagram includes user programmable options: please contact LEM for details.

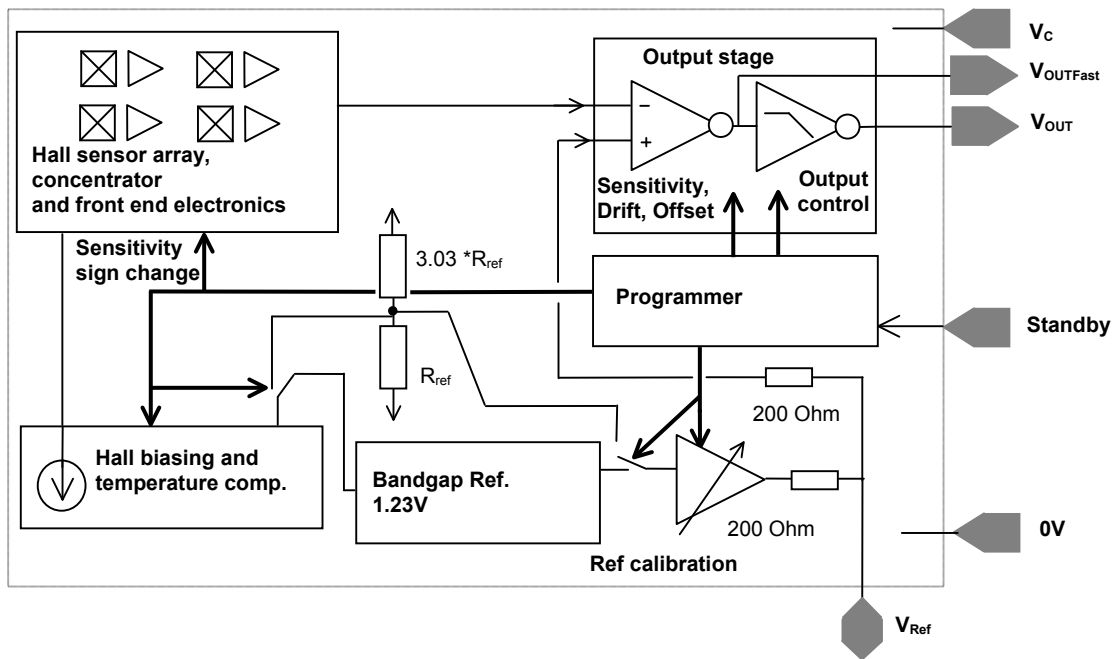

Notes: All parameters are for the V_C range from 4.5 V to 5.5 V, and $T_A = -40^\circ\text{C}$ to $+125^\circ\text{C}$.
Typical values are for $V_C = 5\text{ V}$; $T_A = 25^\circ\text{C}$. Values are for the application schematic shown in figure 6.

Electrical data

Parameter	Symbol	Unit	Min	Typ	Max	Conditions
Supply voltage	V_C	V	4.75	5	5.5	4.5 V possible but limits measurement range
Current consumption	I_C	mA		15	19	Operating mode
		μA			20	Standby mode
Output voltage in a flux density B	V_{OUT}	V	$V_{REF} + V_{OE} + (G \times B)$			Simplified model
Magnetic flux density measuring range	B_M	mT		± 3.3		$V_C = 5\text{ V}$
Linearity error	ϵ_L	%	-1.5	± 0.4	1.5	$G_B = 600\text{ mV/mT}$, $B = \pm 3.3$, $V_C = 5\text{ V}$
Sensitivity, referred to magnetic field	G_B	mV/mT	582	600	618	@ 25°C , $V_C = 5\text{ V}$
Sensitivity - V_C influence		% of $V_C = 5\text{ V}$ value	-1		1	@ 25°C , @ $V_C = 5\text{ V} \pm 10\%$
Temperature coefficient of G_B	TCG	ppm/ $^\circ\text{C}$	-350		350	Referred to 25°C ; 3 sigma limits
Reference voltage (Internal reference used as output)	V_{REF}	V	2.480	2.5	2.52	@ 25°C , $V_C = 5\text{ V}$
Regulation V_C		mV/V	-5		5	@ 25°C , $V_C = 5\text{ V} \pm 10\%$
Output impedance V_{REF}		Ω	150	200	250	
Temperature coefficient of V_{REF}	TCV_{REF}	ppm/ $^\circ\text{C}$	-80		80	$25^\circ\text{C} - 125^\circ\text{C}$; 3 sigma limits
Temperature coefficient of V_{REF}	TCV_{REF}	ppm/ $^\circ\text{C}$	-100		100	$-40^\circ\text{C} - 25^\circ\text{C}$; 3 sigma limits
Reference voltage (External reference used as input)	V_{REF}	V	1.5		2.8	
Additional sensitivity error		%/V	-1		1	Relative to 2.5 V
Additional electrical offset voltage		mV/V	-40		20	Relative to 2.5 V
Electrical offset voltage $V_{OUT} - V_{REF}$	V_{OE}	mV	-10		10	@ 25°C , $B = 0$; $V_C = 5\text{ V}$
Electrical offset voltage $V_{OUTFast} - V_{REF}$	V_{OEFast}	mV		± 50		@ 25°C , $B = 0$; $V_C = 5\text{ V}$
Temperature coefficient of V_{OE} and V_{OEFast}	TCV_{OE}	mV/ $^\circ\text{C}$	-0.15		0.15	Referred to 25°C and V_{REF} ; 3 sigma limits
Offset - V_C influence (V_{OE} and V_{OEFast})		mV	-10		10	@ 25°C , $V_C = 5\text{ V} \pm 10\%$
Output resistance V_{OUT}	R_{OUT}	Ω			5	DC
Output resistance $V_{OUTFast}$	$R_{OUTFast}$	Ω			10	DC
Output current magnitude V_{OUT}	I_{OUT}		30			As source
			50			As sink
Output current magnitude $V_{OUTFast}$	$I_{OUTFast}$		5			As source
			10			As sink
Maximum output capacitive loading	C_L	nF			18	4.7 nF recommended
Standby pin "0" level		V			+0.5	
Standby pin "1" level		V	$V_C - 0.5$		$V_C + 0.3$	For standby mode
Time to switch from standby to normal mode		μs		60		90 % of correct output
Output voltage noise V_{OUT} and $V_{OUTFast}$	V_{no}	$\mu\text{Vrms}/\sqrt{\text{Hz}}$		15		$f = 1500\text{ Hz} - 100\text{ Hz}$
Internal Clock feed through V_{OUT}		μVrms		400		($f = 500\text{ kHz typ}$)
Internal Clock feed through $V_{OUTFast}$		μVrms		1600		($f = 500\text{ kHz typ}$)
Reaction time V_{OUT}	t_{ra}	μs			3	Input signal rise time 1 μs
Response time V_{OUT}	t_r	μs			5	Input signal rise time 1 μs
Reaction time $V_{OUTFast}$	t_{raFast}	μs			3	Input signal rise time 1 μs
Response time $V_{OUTFast}$	t_{rFast}	μs			3	Input signal rise time 1 μs
Frequency bandwidth V_{OUT}	BW	kHz		105		@ -3 dB (Kit 9)
				45		@ -1 dB (Kit 9)
Frequency bandwidth $V_{OUTFast}$	BW_{Fast}	kHz		120		@ -3 dB (Kit 9)
				55		@ -1 dB (Kit 9)

Typical performance characteristics

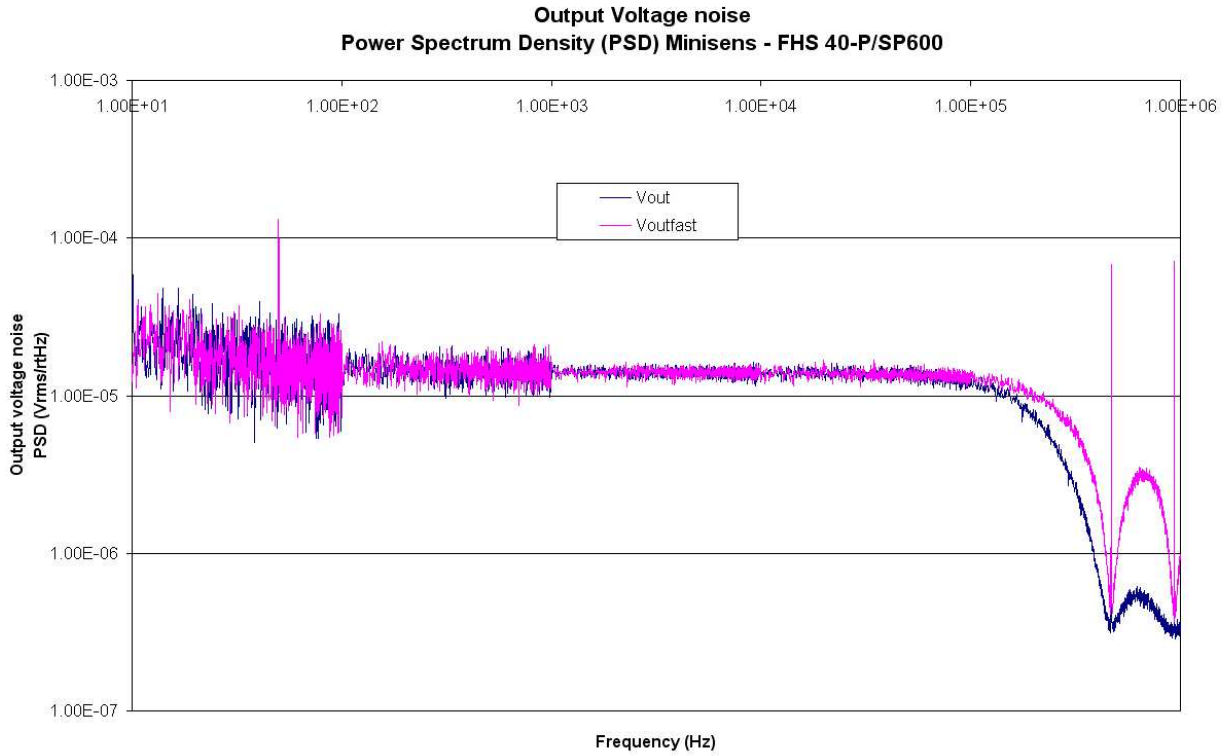

Figure 1: Output voltage noise

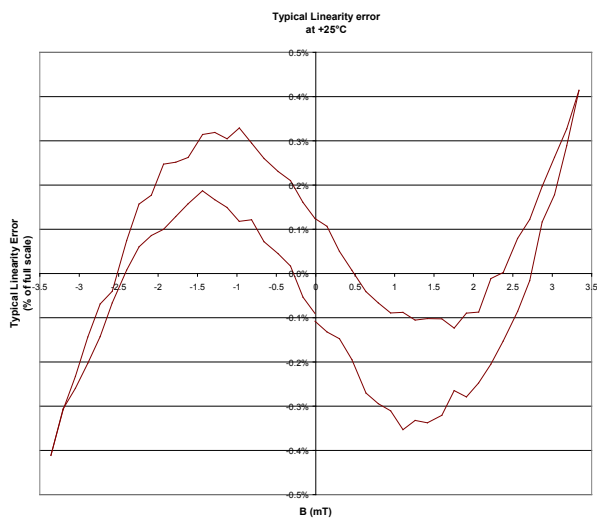

Figure 2: Typical linearity error at +25°C

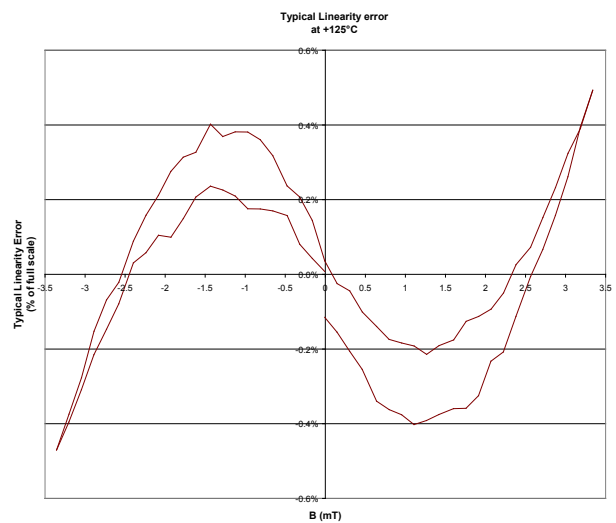

Figure 3: Typical linearity error at +125°C

Typical performance characteristics

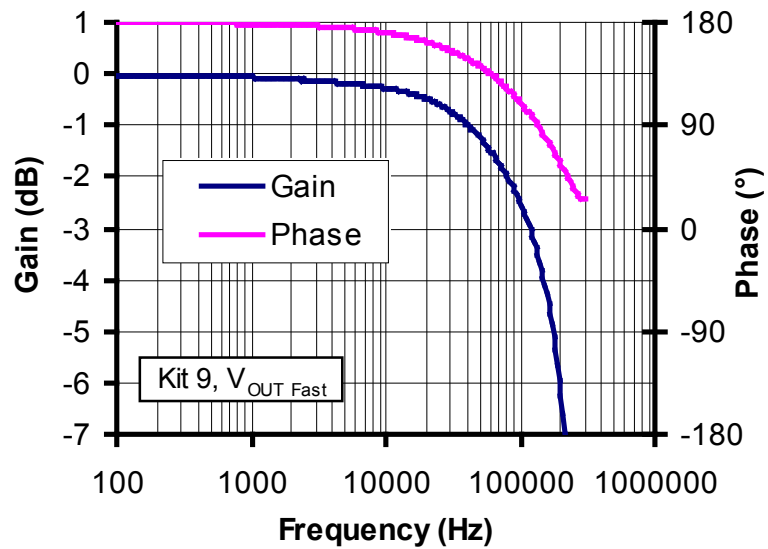
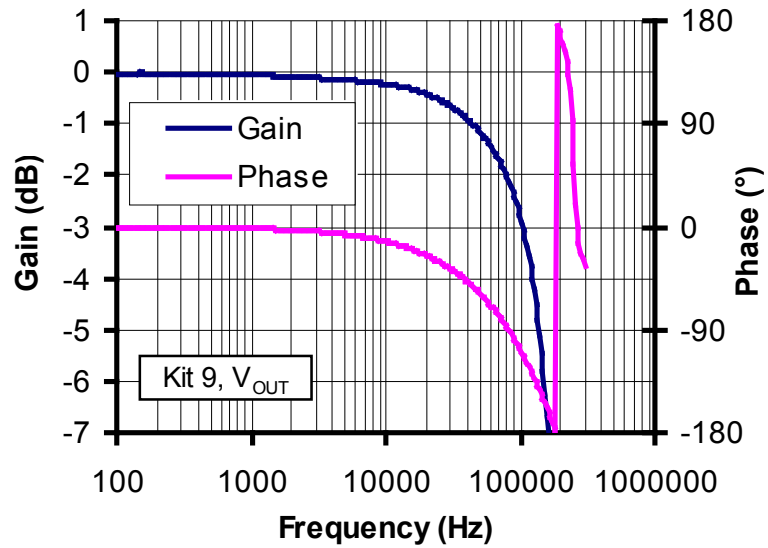

Figure 4: Typical frequency and phase response; V_{OUT} and $V_{OUT\ Fast}$

Typical performance characteristics

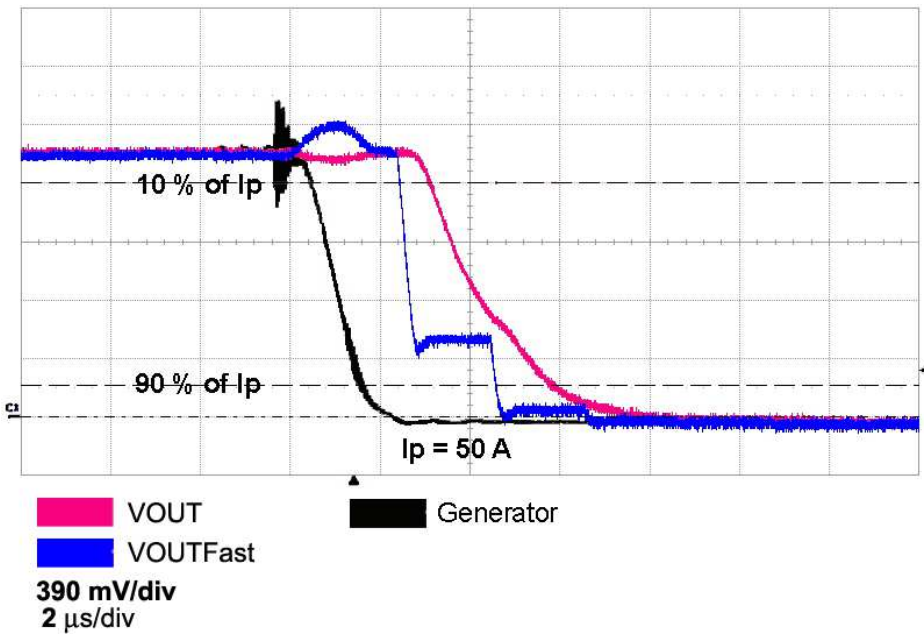
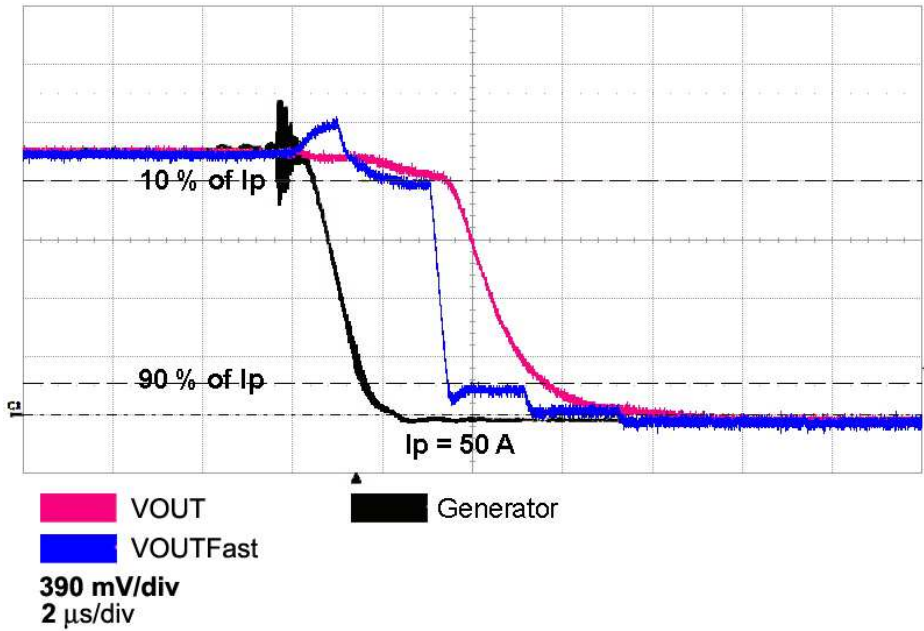

Figure 5: Best and worst case di/dt response - V_{OUT} and $V_{OUTFast}$
Conditions: $I_p = 50 \text{ A}$ - primary track on opposite side of PCB

Typical connection diagram and ground plane

Values of the electrical data given page 3 are according to the following connection diagram.

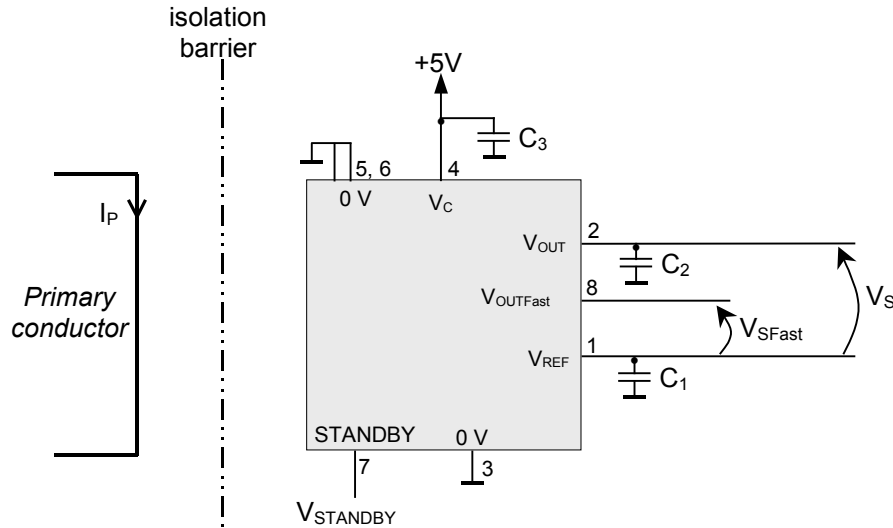

Figure 6: Typical connection diagram ($C_1 = C_3 = 47 \text{ nF}$, $C_2 = 4.7 \text{ nF}$)

Careful design of the PCB is needed to ensure minimum disturbance by surrounding currents and external fields. C_1 to C_3 should be mounted as close as possible to the pins.

The maximum capacitor value allowed on V_{OUT} is 18 nF. It is recommended to use 4.7 nF.

The maximum capacitor value allowed on $V_{OUTFast}$ is 330 pF.

A positive output voltage V_S is obtained with a current (I_P) flowing under Minisens from the pin 4/5 end of the package to the pin 1/8 end. V_{SFast} is negative when V_S is positive.

If the pin $V_{OUTFast}$ is not used, it should be connected only to a small solder pad. Coupling to other tracks should be minimized.

An internally generated reference voltage of 2.5 V with a source resistance of 200 Ω is available on the pin V_{REF} . The voltage on this pin may be forced externally with a voltage in the range 1.5 - 2.8 V. The output voltage V_S is limited to approximately the value of V_{REF} in both positive and negative polarities.

$V_{STANDBY}$ should be connected to a low impedance so that capacitive coupling from adjacent tracks does not disturb it (there is an internal pull-down whose resistance is 500 k Ω). It should be connected to 0 V if not used.

Connect $V_{STANDBY}$ to the same voltage as V_C to activate the Standby mode. V_{REF} should not be forced in Standby mode.

Minisens can be directly mounted above the PCB track in which the current to be measured flows (see kit 4, for example).

Typical connection diagram and ground plane

Good EMC practice requires the use of ground planes on PCBs. In drives where high dV/dt transients are present, a ground plane between the primary conductor and Minisens will reduce or avoid output perturbations due to capacitive currents. However, the ground plane has to be designed to limit eddy currents that would otherwise slow down the response time. The effect of eddy currents is made negligible by cutting the copper plane under the package as shown in figure 7:

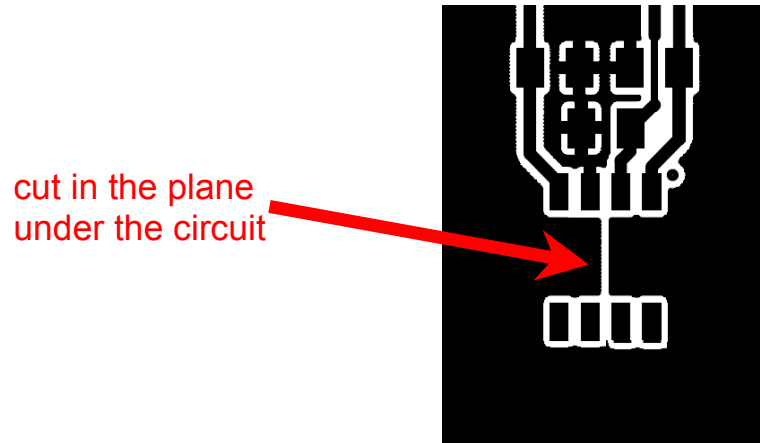

Figure 7: Top side copper plane has a cut under the IC to optimize response time

Application information

Basic operation: example with a long thin conductor

Minisens is a galvanically isolated current transducer. It senses the magnetic field generated by the measured current and transforms it into an output voltage.

If the current is bidirectional, Minisens will sense the polarity of the magnetic field and generate a positive or negative output voltage relative to the reference voltage.

A simple case is presented which illustrates the current to magnetic field and then to output voltage conversion.

A current flowing in a long thin conductor generates a flux density around it: $B = \frac{\mu_0}{2\pi} \cdot \frac{I_p}{r}$ (T)

with I_p the current to be measured (A)
 r the distance from the center of the wire (m)
 μ_0 the permeability of vacuum (physical constant, $\mu_0 = 4 \cdot \pi \cdot 10^{-7}$ H/m)

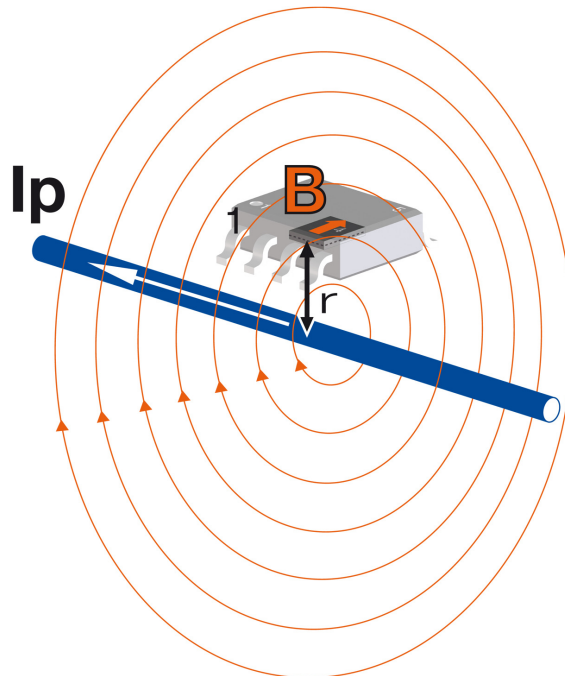

Figure 8: Minisens orientation to measure the magnetic field generated by a current along a conductor

If Minisens is now placed in the vicinity of the conductor (with its sensitivity direction colinear to the flux density B), it will sense the flux density and the output voltage will be:

$$V_s = G_B \cdot B = G_B \cdot \frac{\mu_0}{2\pi} \cdot \frac{I_p}{r} = 1.2 \cdot 10^{-4} \cdot \frac{I_p}{r} \text{ (V)}$$

where G_B is the Minisens magnetic sensitivity (600 V/T)

The sensitivity is therefore: $G = \frac{V_s}{I_p} = \frac{1.2 \cdot 10^{-4}}{r} \text{ (V/A)}$

The next graph shows how the output voltage decreases when r increases. Note that the sensitivity also depends on the primary conductor shape.

Application information

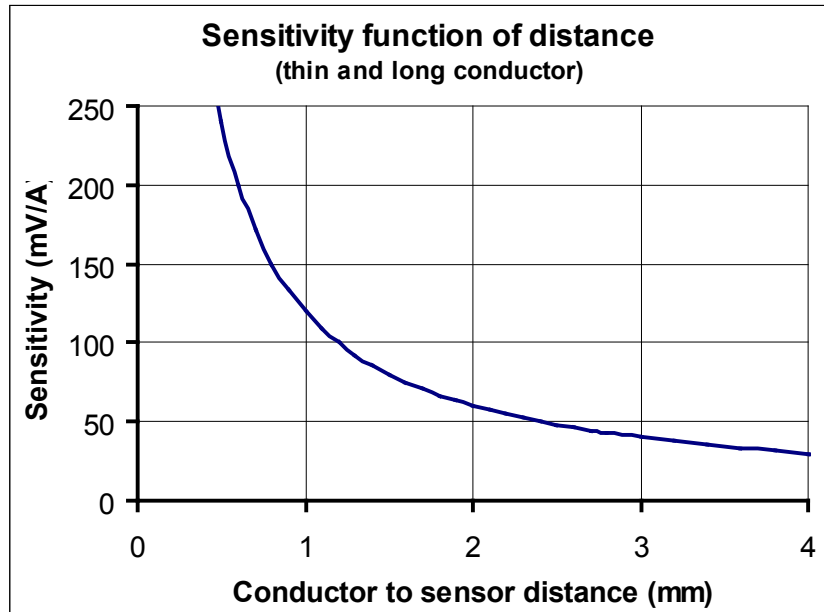

Figure 9: Sensitivity versus the distance between the conductor and the Minisens sensing elements

The example above is of limited practical use as most conductors are not round and thin but explains the principles of Minisens operation.

The measuring range limit (I_{PM}) is reached when the output voltage ($V_{OUT} - V_{REF}$) reaches 2 V.

This limit is due to electrical saturation of the output amplifier. The input current or field may be increased above this limit without risk for the circuit.

Recovery will occur without additional delay (same response time as usual).

The maximum current that can be continuously applied to the transducer (I_{PM}) is only limited by the primary conductor carrying capacity.

Application information

Single track on PCB

The main practical configurations will now be reviewed and their main features highlighted.

The use of Minisens to measure a current flowing in a track provides the following advantages:

- Isolation is guaranteed by PCB design. If the primary track is placed on the opposite (bottom) side of the PCB, the isolation can be very high
- stable and reproducible sensitivity
- inexpensive
- large input currents (up to about 100 A).

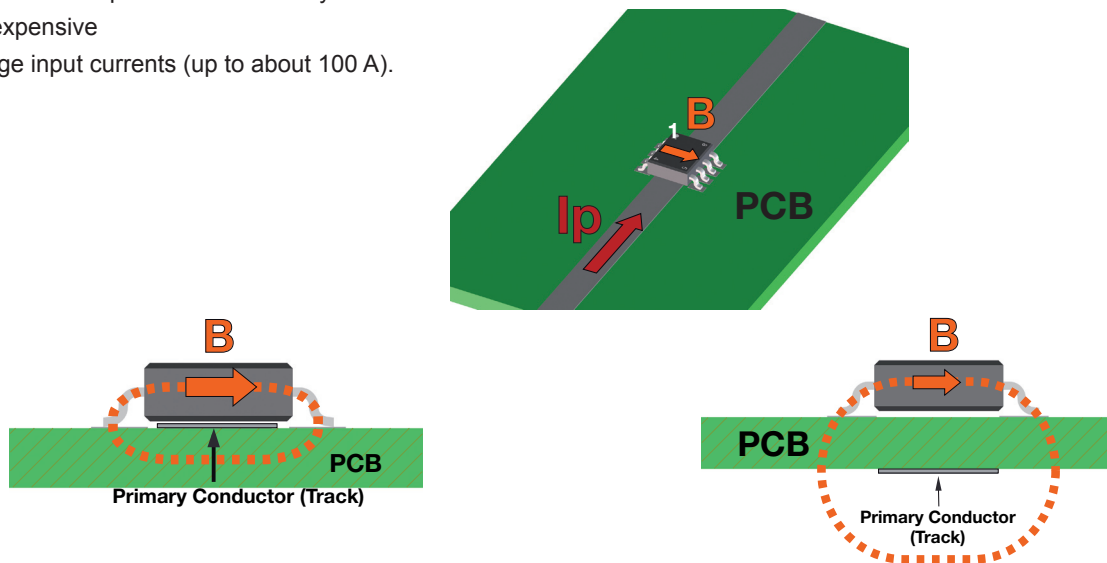

Figure 10: Principle of Minisens used to measure current in a PCB track

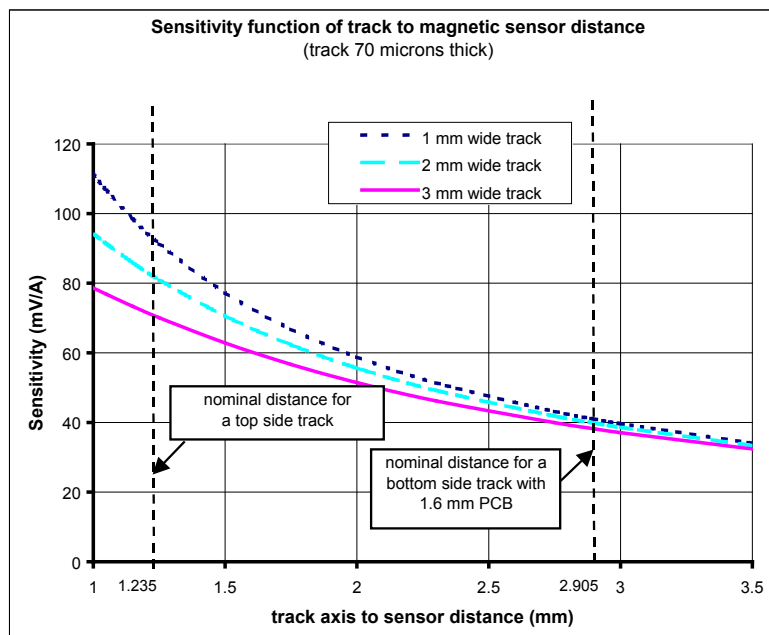

Figure 11: Sensitivity versus track width and versus distance between the track and the Minisens sensing elements

Application information

The sensitivity depends on the track width and distance, as shown in figure 11.

The maximum current that can be safely applied continuously is determined by the temperature rise of the track. The use of a track with varying width gives the best combination of sensitivity and track temperature rise.

The following paragraphs show optimized track shapes for bottom and top side tracks. they are only examples and there could be many others depending on the application requirements.

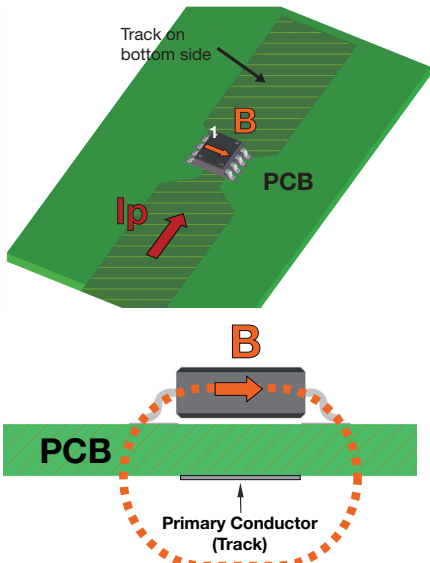
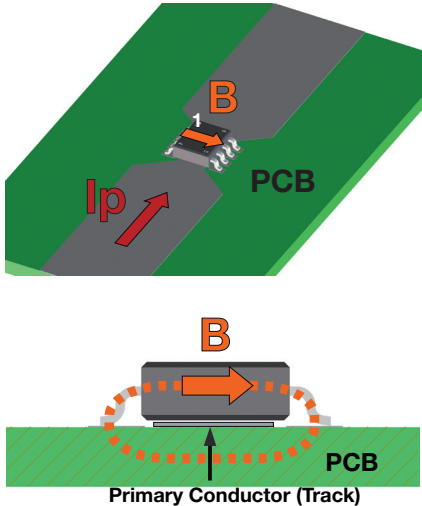
Track bottom side High isolation configuration			Track top side Low isolation configuration	
				
	KIT 5	KIT 9		KIT 4
Creeepage, clearance	8 mm	8 mm	Creeepage, clearance	0.4 mm
Nominal primary current IPN	16 A	30 A	Nominal primary current IPN	16 A
(85°C ambient, natural convection, 30°C track temperature rise)				
Measuring range IPM	55 A	76 A	Measuring range IPM	29 A
Sensitivity G	36 mV/A	26 mV/A	Sensitivity G	68.7 mV/A
Track width under IC	3 mm	8 mm	Track width under IC	3 mm
Track width elsewhere	10 mm	16 mm	Track width elsewhere	10 mm
A demo board of this design is available	G2.00.23.104.0	GE.00.23.108.0	A demo board of this design is available	G2.00.23.103.0
PCB characteristics	1.6 mm / 70 µm Cu		PCB characteristics	70 µm Cu

Application information

Multi-turns

For low currents (under 10 A), it is advisable to make several turns with the primary track to increase the magnetic field generated by the primary current.

As with a single track, it is better to have wider tracks around the Minisens than under it (to reduce temperature rise)

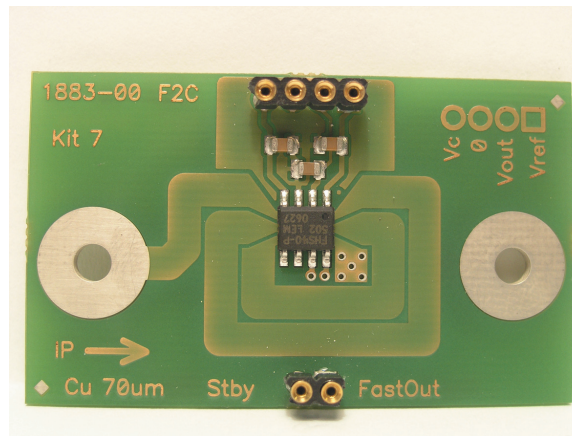
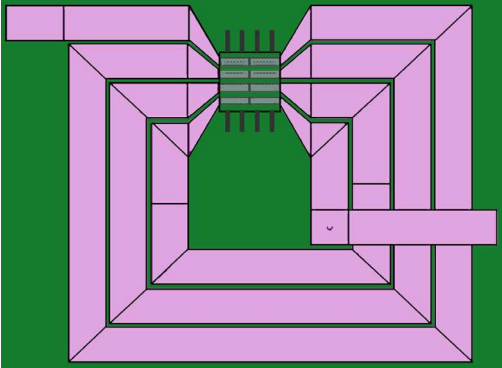
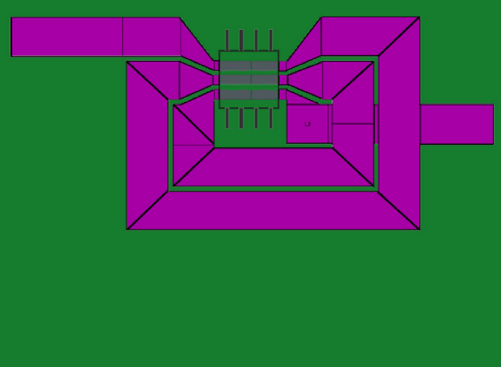

Figure 12: Example of multi-turns PCB design

Two optimized design examples are presented below.

4 turns bottom side High isolation configuration		3 turns bottom side Low isolation configuration	
			
	KIT 8		KIT 7
Creeepage, clearance	8 mm	Creeepage, clearance	0.4 mm
Nominal primary current I_{PN} (85°C ambient, natural convection, 30°C track temperature rise)	5 A	Nominal primary current I_{PN} (85°C ambient, natural convection, 30°C track temperature rise)	5 A
Measuring range I_{PM}	15 A	Measuring range I_{PM}	10 A
Sensitivity G	126 mV/A	Sensitivity G	186 mV/A
Track width under IC	0.78 mm	Track width under IC	0.78 mm
Track width elsewhere	3 mm	Track width elsewhere	3 mm
A demo board of this design is available	GE.00.23.107.0	A demo board of this design is available	GE.00.23.106.0
PCB characteristics 1.6 mm / 70 µm Cu		PCB characteristics 1.6 mm / 70 µm Cu	

Application information

Jumper

The use of a jumper and PCB tracks to realize a complete loop around Minisens allows it to have a very high sensitivity for a nominal current of about 10 Amps.

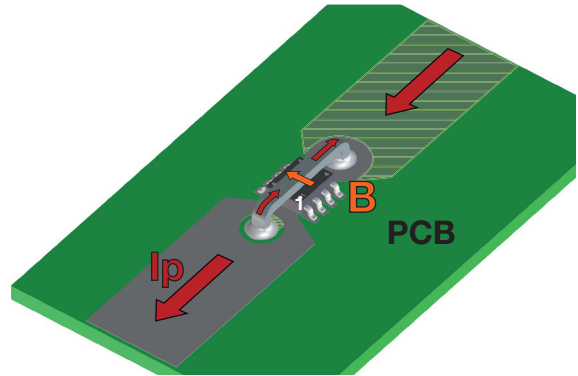
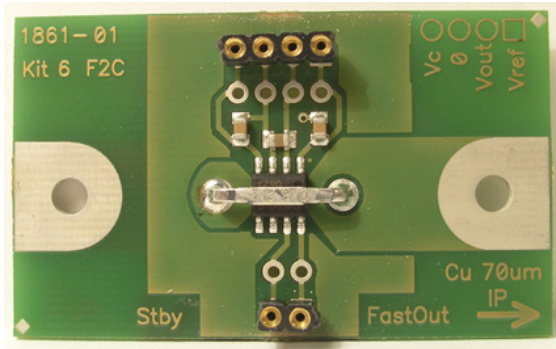

Creepage, clearance
Nominal primary current I_{PN}
(85°C ambient, natural convection,
30°C track temperature rise)
Measuring range I_{PM}
Sensitivity G
Track width under IC
Track width elsewhere
A demo board of this
design is available
PCB characteristics 1.6 mm / 70 μ m Cu.

KIT 6
0.4 mm
9 A

9 A
206 mV/A
3 mm
10 mm
GE.00.23.105.0

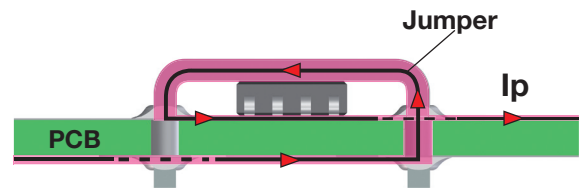

Cable or busbar

For very large currents (>50A), Minisens can be used to measure the current flowing in a cable or busbar.
The position of Minisens relatively to the conductor has to be stable to avoid sensitivity variations.

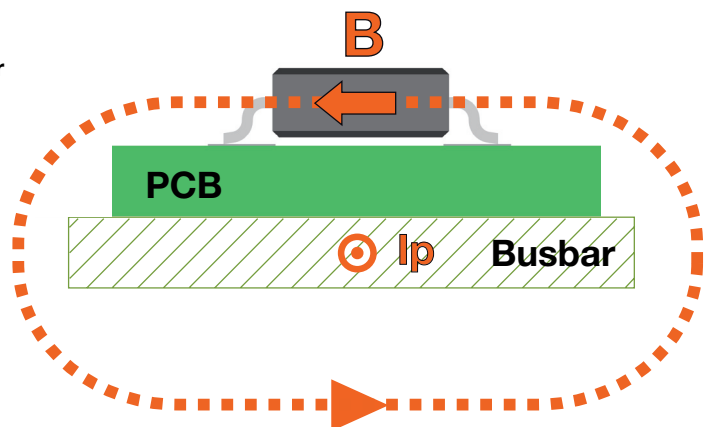
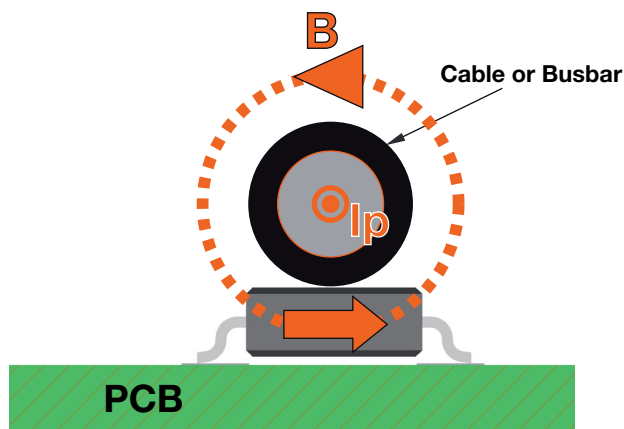

Application information

Accuracy considerations

Several factors influence the output accuracy of Minisens as a current transducer:

1. The sensitivity of the Minisens
2. The distance and shape of the primary conductor
3. The circuit output offset
4. The circuit non-linearity
5. Stray fields

The sensitivity of the Minisens is calibrated during production at $600 \text{ V/T} \pm 3\%$.

As already mentioned, the distance and shape of the primary conductor also influence the sensitivity.

No relative movement of the primary conductor to Minisens should be possible.

To avoid differences in a production, the position and shape of the primary conductor and circuit should always be identical.

The magnetic fields generated by neighbouring conductors, the earth's magnetic field, magnets, etc. are also measured if they have a component in the direction to which Minisens is sensitive (see figure 8).

As a general rule, the stronger the field generated by the primary current, the smaller the influence of stray fields and offset.

The primary conductor should therefore be designed to maximize the output voltage.

For more details on the accuracy calculation, please consult the "Minisens design guide".

Performance parameters definition

Sensitivity & Linearity

Sensitivity: the Sensitivity G_B is defined as the slope of the linear regression line for a magnetic field cycle between $\pm B$ mT, where B is the magnetic field for full scale output.

Linearity error: for a field strength b in a cycle whose maximum field strength is B , the linearity error is:

$$\text{Error}(b) = ((V_s(b) - (bG_B)) / BG_B) \times 100 \%$$

where $V_s(b)$ is the output voltage, relative to the reference voltage, for the field b .

The maximum value of Error (b) is given in the electrical data.

Temperature coefficient of G: TCG

This is referred to 25 degrees.

Response and reaction times:

The response time t_r , and the reaction time t_{ra} are shown in figure 13. The primary current rise time is 1 μ s.

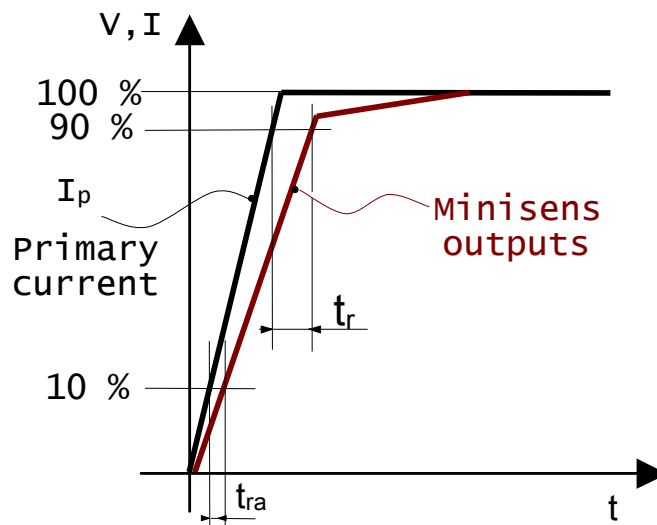
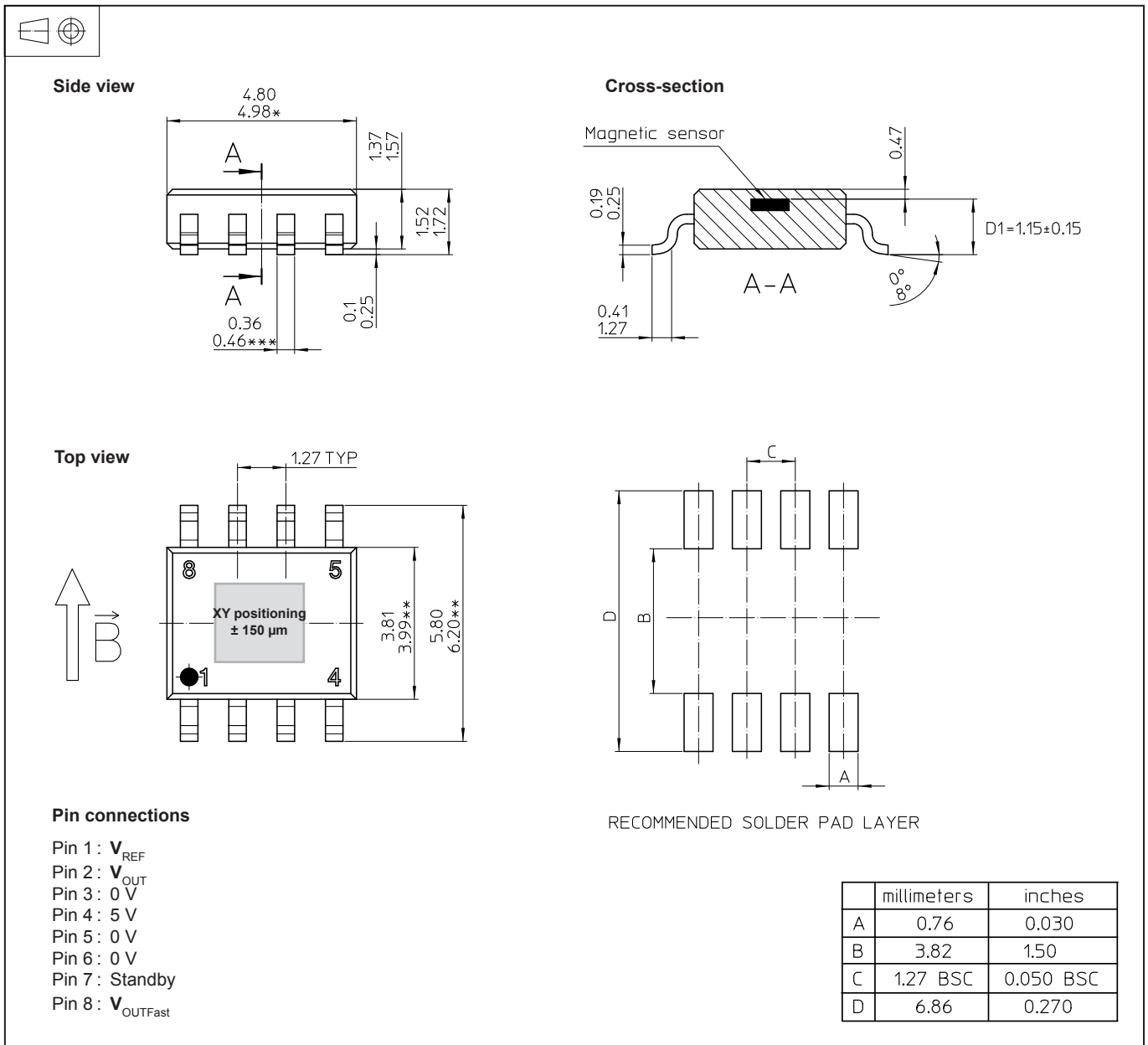

Figure 13: response time t_r and reaction time t_{ra}

Dimensions FHS 40-P/SP600 (in mm)



Mechanical characteristics

- Recommended reflow soldering profile
as standard: IPC/JEDEC J-STD-020 revision C
- Mass 0.08 g
- Tape and reel quantity 3000 parts

Notes:

All dimensions are in millimeters (angles in degrees)

* Dimensions do not include mold flash, protrusions or gate burrs (shall not exceed 0.15 per side).

** dimension does not include interleads flash or protrusion (shall not exceed 0.25 per side).

*** Dimension does not include dambar protrusion.

Allowable dambar protrusion shall be 0.08 mm total in excess of the dimension at maximum material condition.

Dambar cannot be located on the lower radius of the foot.

Tape and Reel dimensions

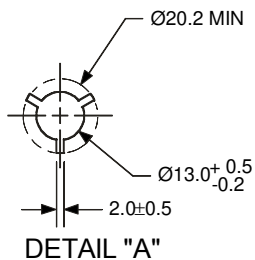
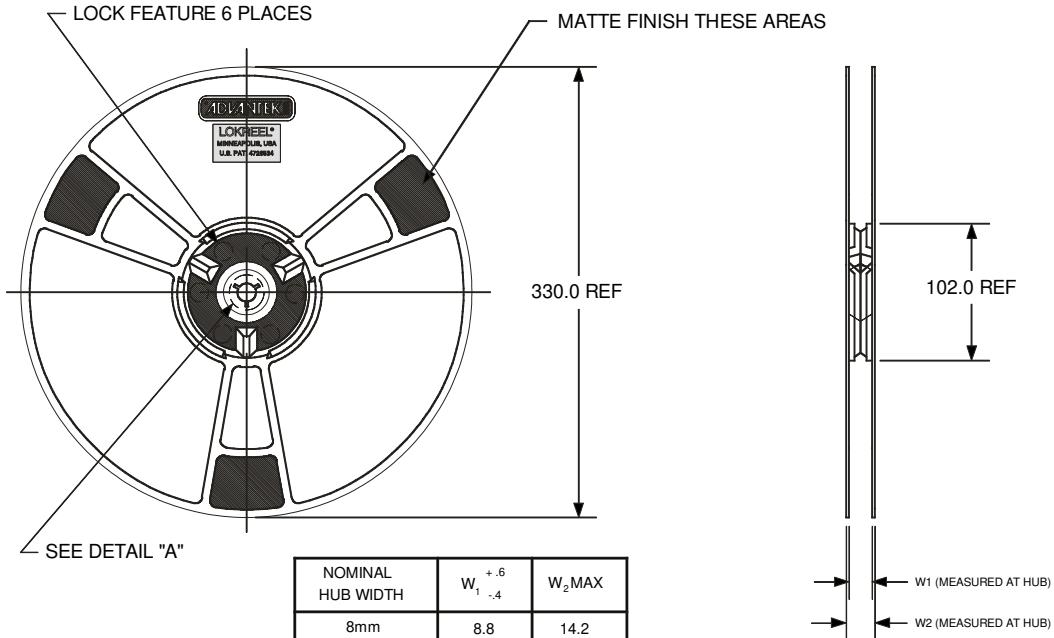

NOMINAL HUB WIDTH	$W_1^{+.6}_{-.4}$	W_2 MAX
8mm	8.8	14.2
12mm	12.8	18.2
16mm	16.8	22.2
24mm	24.8	30.2
32mm	32.8	38.2
44mm	44.8	50.2
56mm	56.8	62.2

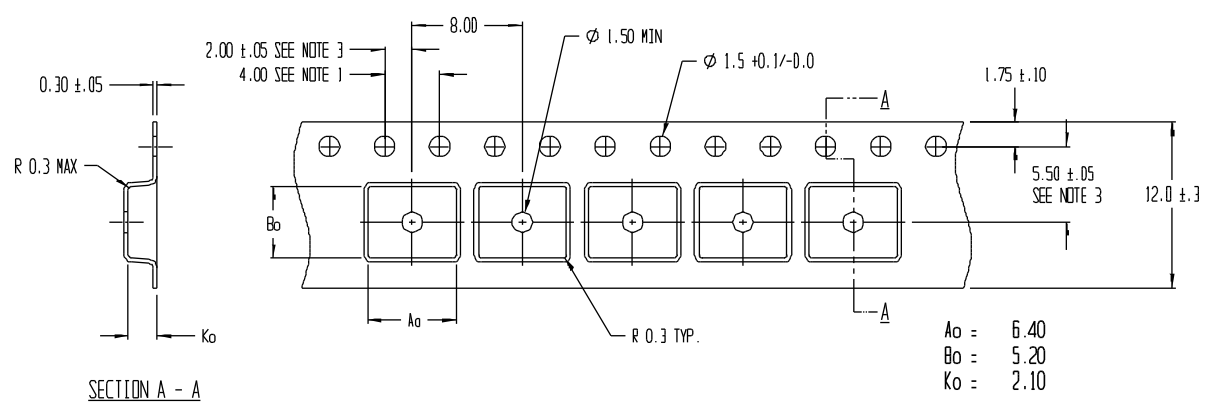

- Notes:**
- 1) 10 Sprocket hole pitch cumulative tolerance ± 0.2 mm
 - 2) Camber in compliance with EIA 481
 - 3) Pocket position relative to sprocket hole measured as true position of pocket, not pocket hole.

All dimensions are in mm.