



Chipsmall Limited consists of a professional team with an average of over 10 year of expertise in the distribution of electronic components. Based in Hongkong, we have already established firm and mutual-benefit business relationships with customers from,Europe,America and south Asia,supplying obsolete and hard-to-find components to meet their specific needs.

With the principle of "Quality Parts,Customers Priority,Honest Operation,and Considerate Service",our business mainly focus on the distribution of electronic components. Line cards we deal with include Microchip,ALPS,ROHM,Xilinx,Pulse,ON,Everlight and Freescale. Main products comprise IC,Modules,Potentiometer,IC Socket,Relay,Connector.Our parts cover such applications as commercial,industrial, and automotives areas.

We are looking forward to setting up business relationship with you and hope to provide you with the best service and solution. Let us make a better world for our industry!



Contact us

Tel: +86-755-8981 8866 Fax: +86-755-8427 6832

Email & Skype: info@chipsmall.com Web: www.chipsmall.com

Address: A1208, Overseas Decoration Building, #122 Zhenhua RD., Futian, Shenzhen, China



908701NS
(ON ONIWARD)号番面図

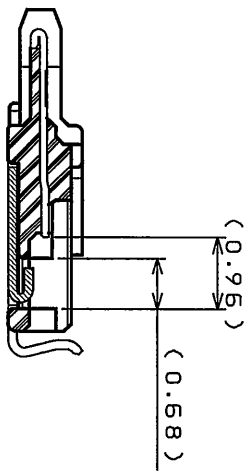
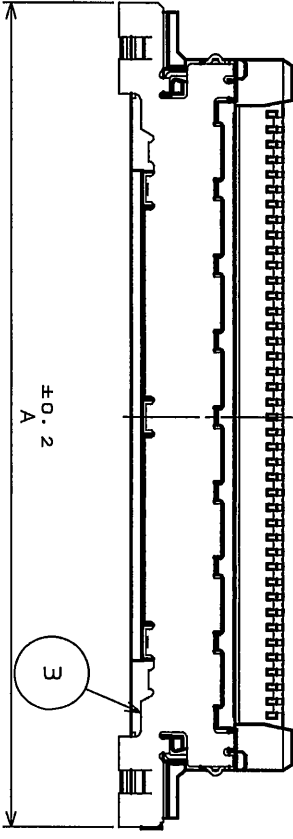
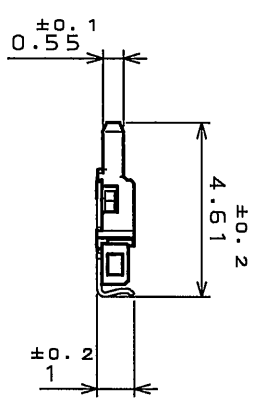
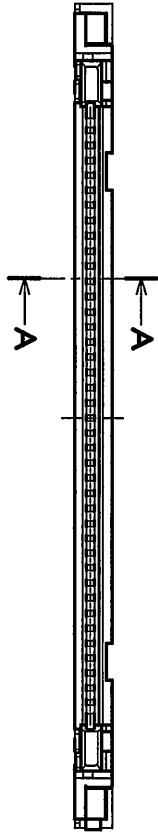
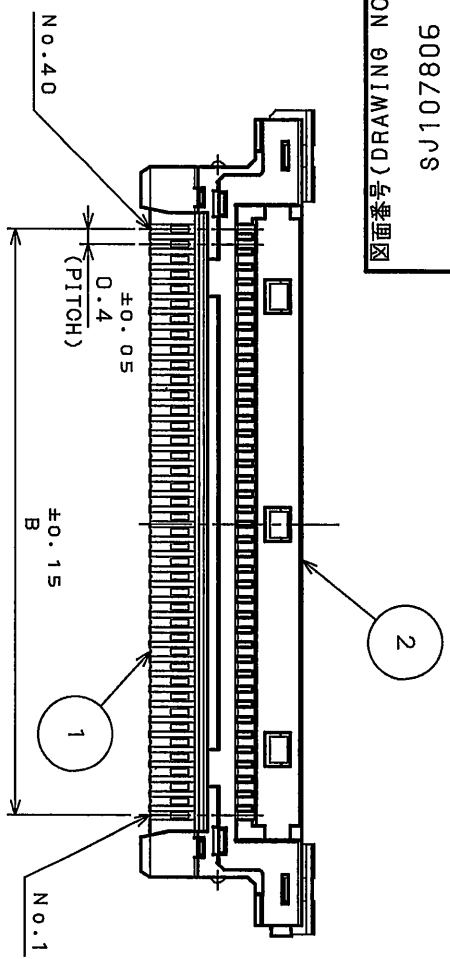

SECT. A-A
(SCALE 10:1)

MATED CONDITION(REF.)
嵌合状態(参考)

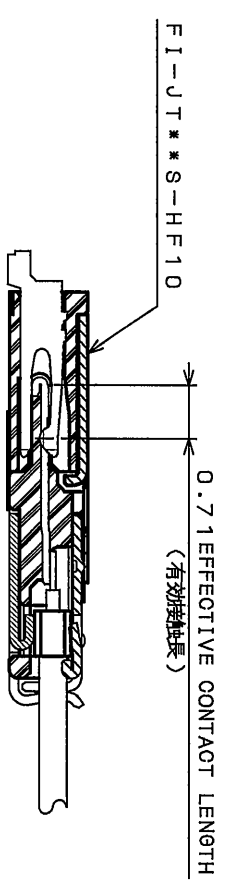

SECT.OF MATED CONDITION(REF.)
嵌合状態断面図(参考)

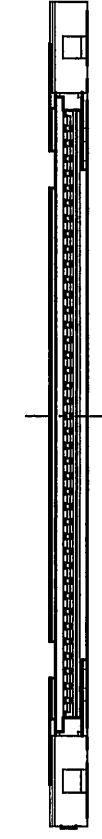
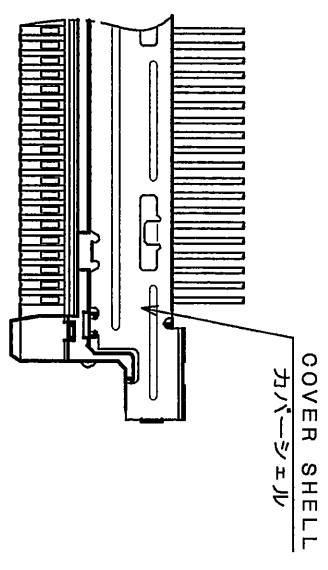
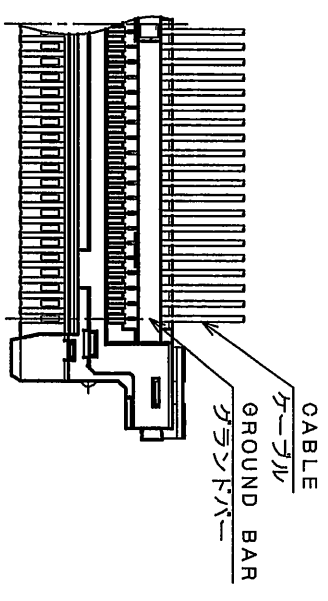

TABLE 1

No. OF CONTACTS	A	B
40	21.9	15.6



CABLE ASSEMBLED
CONDITION(REF.)
ケーブル組込状態図(参考)

COVER SHELL ASSEMBLED
CONDITION(REF.)
カバースhell組込状態図(参考)

REV.	DATE	DCN NO.	ADDED NOTE	変更内容 DESCRIPTION	製図 DR.	担当 CHK.	査閲 APPD.	承認 APPD.
2	26.Sep.2007	064025	追加注記			M.KIKUCHI		K.Hosokawa

0 10 20 30 40 50 60 70 80 90 100

公差(GENERAL TOLERANCE)		角度(ANGLES)	
寸法(DIMENSION)	±	角度(ANGLES)	X° ±
	±		X° ±
	±		±
	±		±

符号 NO.	名称	数量	材料
1	BASE SHELL	1	ステンレス
2	INSULATOR	1	HAET RESISTING PLASTIC
3	CONTACT	**	COPPER ALLOY

仕様書(SPECIFICATION)	第1版(ORIGINAL DATE)	20.Aug.2007
製図	DR.	H.MATSUZAKI
検査	CHK.	M.HIGUCHI
承認	APPD.	K.HISATOMI

名称(TITLE)	FI-JT**C
(CABLE SIDE)	
質量(MASS)	

図面番号(DRAWING NO.)	SJ107806
版数(REV.)	2