



Chipsmall Limited consists of a professional team with an average of over 10 year of expertise in the distribution of electronic components. Based in Hongkong, we have already established firm and mutual-benefit business relationships with customers from,Europe,America and south Asia,supplying obsolete and hard-to-find components to meet their specific needs.

With the principle of "Quality Parts,Customers Priority,Honest Operation,and Considerate Service",our business mainly focus on the distribution of electronic components. Line cards we deal with include Microchip,ALPS,ROHM,Xilinx,Pulse,ON,Everlight and Freescale. Main products comprise IC,Modules,Potentiometer,IC Socket,Relay,Connector.Our parts cover such applications as commercial,industrial, and automotives areas.

We are looking forward to setting up business relationship with you and hope to provide you with the best service and solution. Let us make a better world for our industry!



## Contact us

Tel: +86-755-8981 8866 Fax: +86-755-8427 6832

Email & Skype: info@chipsmall.com Web: www.chipsmall.com

Address: A1208, Overseas Decoration Building, #122 Zhenhua RD., Futian, Shenzhen, China



SJ100490  
図面番号(DRAWING NO.)

版数 REV.	年月日 DATE	DCN NO.	変更内容 DESCRIPTION	製図 DR.	担当 CHK.	査閲 APPD.	承認 APPD.

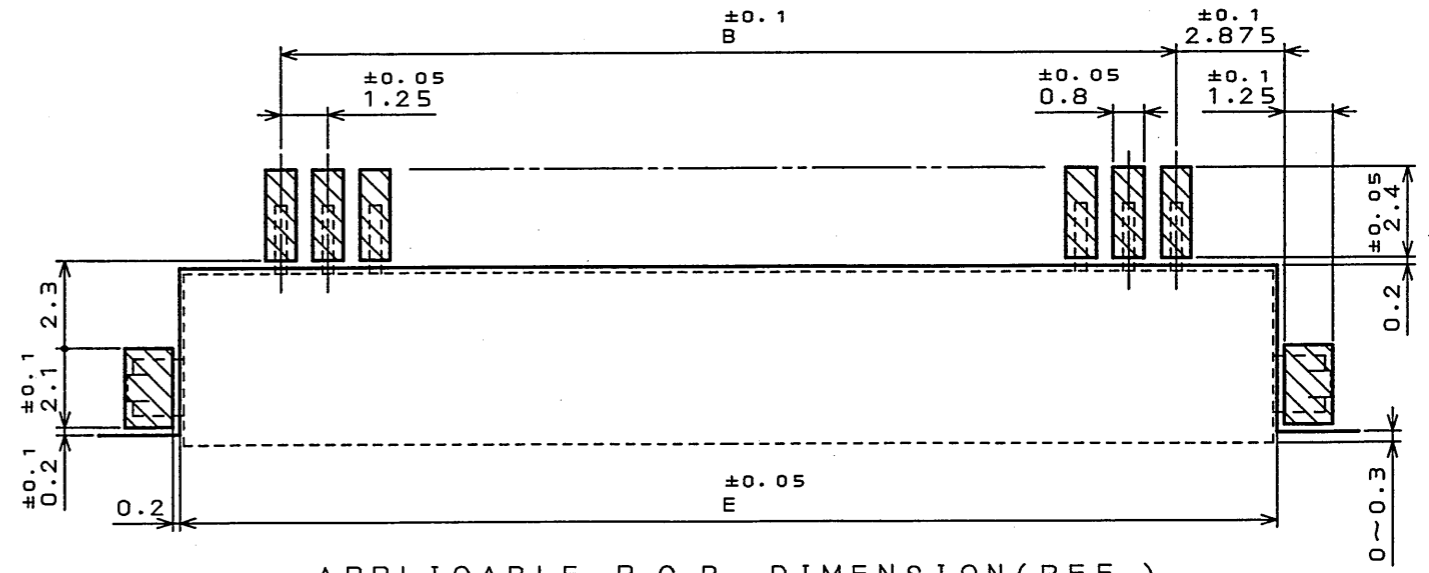
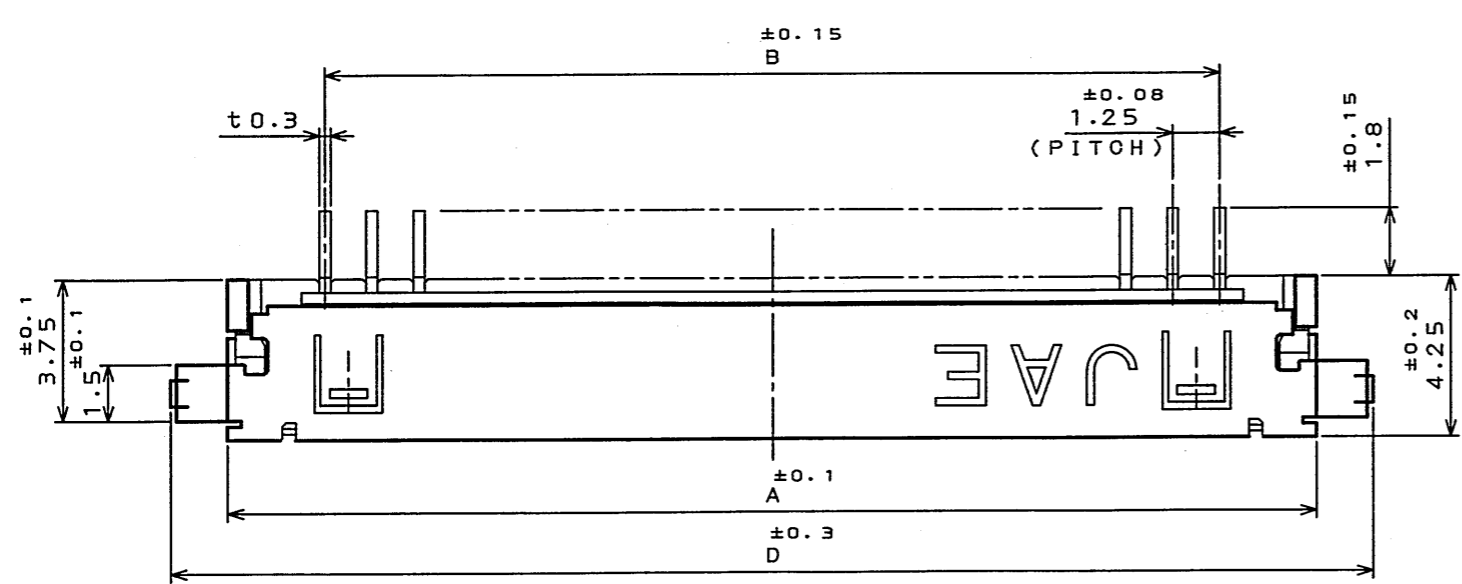

APPLICABLE P.C.B. DIMENSION (REF.)  
適合基板寸法(参考)

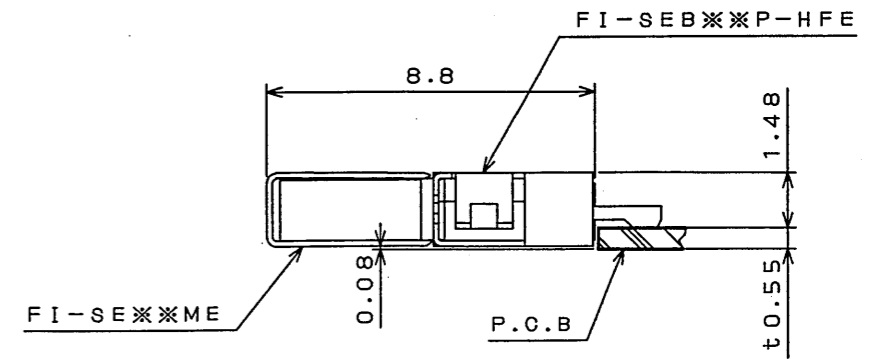
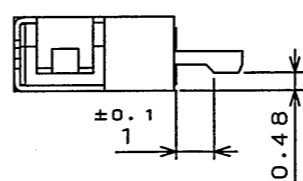
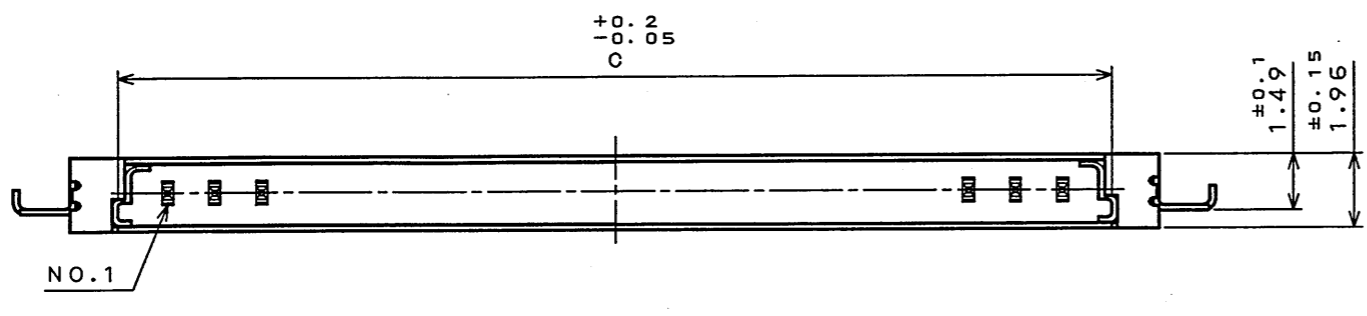

COUNTERPART CONNECTOR  
相手側コネクタ

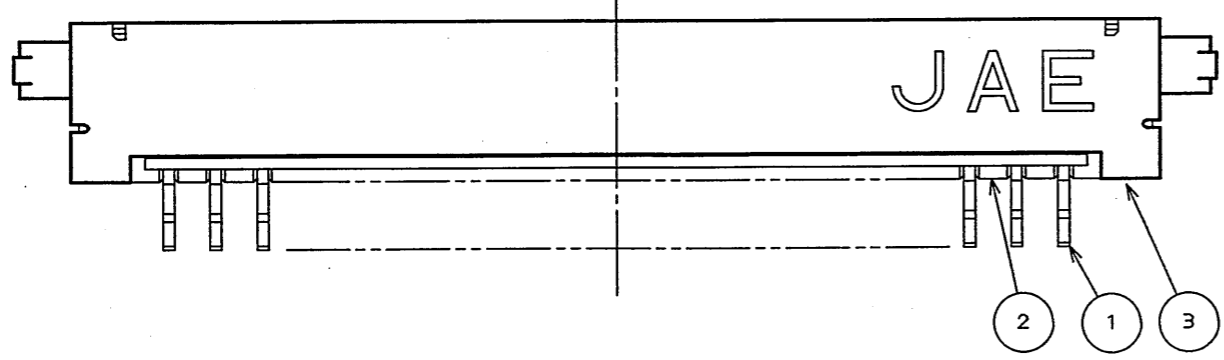

符号 NO.	名称 DESCRIPTION	個数 QTY.	材料 MATERIAL	仕上 FINISH	備考 REMARKS
3	SHELL シェル	1	COPPER ALLOY 銅合金	TIN Snメッキ	
2	INSULATOR インシュレータ	1	GLASS FILLED LCP ガラス入りLCP		UL94-V-0 BEIGE (ベージュ)
1	CONTACT コンタクト	N	COPPER ALLOY 銅合金	GOLD OVER NICKEL Ni上部分Auメッキ	TERMINAL AREA: (LEAD FREE) TIN/TIN ALLOY OVER NICKEL 端子部: Ni上部分Auメッキまたは銅合金(無鉛)メッキ
仕様書 (SPECIFICATION)		第1版 (ORIGINAL DATE) 10.Dec.2003		尺 (SCALE) 5:1	
公差 (GENERAL TOLERANCE)		製図 DR. H.SAKURADA		名称 (TITLE) FI-SEB***P-HFE	
寸法 (DIMENSION)		担当 CHK. T.YAMAJI		JAE CONNECTOR DIV. PROPRIETARY. COPYRIGHT (C) 2003, JAPAN AVIATION ELECTRONICS INDUSTRY, LTD.	
角度 (ANGLES)		査閲 APPD. M. Suzuki			
.		承認 APPD. Y. Ichizono			
.X					
.XX				重量 (WEIGHT)	
.XXX				図面番号 (DRAWING NO.) SJ100490	

TABLE 1

DIMENSION NO. OF CONTACTS (N)	A	B	C	D	E
20	28.9	23.75	26.4	31.9	29.1

DOF-0-212E(03.08)

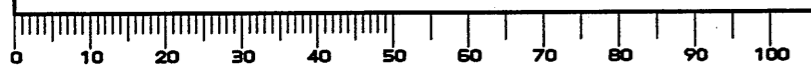

LEAD FREE この製品は鉛フリー品です

JAE CONNECTOR DIV. PROPRIETARY.  
COPYRIGHT (C) 2003, JAPAN AVIATION ELECTRONICS INDUSTRY, LTD.

SIZE A3  
版数 (REV.) 1